













## Specifications (Series luminaires)

|   |                                   |                   |
|---|-----------------------------------|-------------------|
|    | <b>Voltage (V)</b>                | 230V              |
| Hz  | <b>Frecuency (Hz)</b>             | 50-60Hz           |
| $\Phi$  | <b>Power factor (Cos fi)</b>      | >0,5              |
|    | <b>Dimming</b>                    | No                |
|    | <b>Bushing type</b>               | GU10              |
|    | <b>IP Tightness index</b>         | IP20              |
| K   | <b>Colour temperature</b>         | 4.000K            |
|    | <b>CRI Colour rendering index</b> | >80               |
|    | <b>Opening angle</b>              | 100°              |
|  | <b>Measures</b>                   | 50x56mm           |
|  | <b>Operating temperature</b>      | -5°C~+35 °C       |
| $\Phi_{LUM}$  | <b>Flux (lm)</b>                  | 584lm             |
|  | <b>Lifetime</b>                   | (L70B50>) 40.000h |
|  | <b>CEE Energy classification</b>  | F                 |

## References



|  | W    | $\phi$ | $\phi_{LUM}$ | K      | $\leftrightarrow$ |
|---|------|--------|--------------|--------|-------------------|
| <b>575096</b>   | 6,5W | >0,5   | 584lm        | 4.000K | 50x56mm           |

## Dimensions



## Photometry

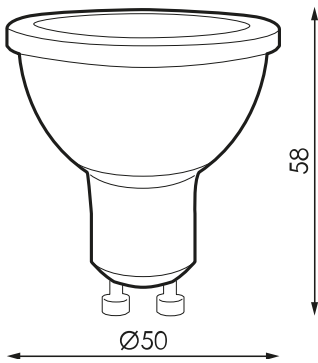

---

**Accessories**

---



---

**974851**

---

GU10/GZ10  
LAMPHOLDER WITH  
SILICONE CABLE