















### Especificaciones (Luminarias de Serie)



	<b>Aislamiento eléctrico</b>	CI
	<b>Tensión (V)</b>	230V
<b>Hz</b>	<b>Frecuencia (Hz)</b>	50-60Hz
	<b>IP Índice de estanqueidad</b>	IP65
	<b>IK Protección contra impactos</b>	IK08
	<b>Color cuerpo</b>	Gris lona
	<b>Difusor</b>	VT-T
	<b>Cuerpo</b>	AL
<b>K</b>	<b>Temperatura de color</b>	5.000K
	<b>CRI Índice de repr. cromática</b>	>70
	<b>Ángulo de apertura</b>	90°
	<b>Dimensiones</b>	245x365x52mm
	<b>Temp. de funcionamiento</b>	-5°C~+35 °C
	<b>Flujo luminoso (lm)</b>	14.594lm
	<b>Vida útil</b>	(L70B50>) 30.000h

## Referencias





	W	$\phi_{LUM}$	K		
<b>576758</b>	90W	14.594lm	5.000K	Gris lona	245x365x52mm

## Dimensiones

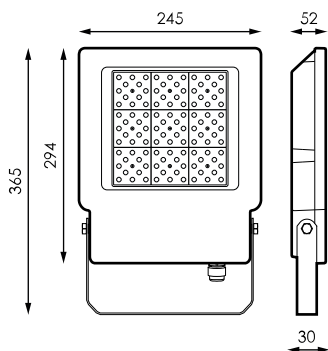

## Fotometría



<b>Info</b>	
Protector contra sobretensiones:	