















## Specifications (Series luminaires)

	<b>Electrical isolation</b>	CI
	<b>Voltage (V)</b>	230V
<b>Hz</b>	<b>Frecuency (Hz)</b>	50-60Hz
	<b>IP Tightness index</b>	IP65
	<b>IK Impact resistance</b>	IK08
	<b>Body color</b>	Canvas grey
	<b>Diffuser Material</b>	VT-T
	<b>Body</b>	AL
<b>K</b>	<b>Colour temperature</b>	3.000K
	<b>CRI Colour rendering index</b>	>70
	<b>Opening angle</b>	90°
	<b>Measures</b>	303x439x60mm
	<b>Operating temperature</b>	-5°C~+35 °C
	<b>Flux (lm)</b>	26.588lm
	<b>Lifetime</b>	(L70B50>) 50.000h

## References





	W	$\phi_{LUM}$	K		
<b>576765</b>	160W	26.588lm	3.000K	Canvas gray	303x439x60mm

## Dimensions

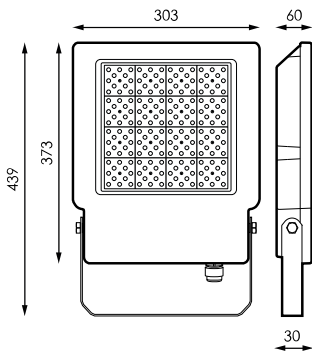

## Photometry



<b>Info</b>	
Surge protector	