















Especificaciones (Luminarias de Serie)

	Aislamiento eléctrico	CI
	Tensión (V)	230V
Hz	Frecuencia (Hz)	50-60Hz
	IP Índice de estanqueidad	IP65
	IK Protección contra impactos	IK08
	Color cuerpo	Gris lona
	Difusor	VT-T
	Cuerpo	AL
K	Temperatura de color	3.000K
	CRI Índice de repr. cromática	>70
	Ángulo de apertura	90°
	Dimensiones	303x439x60mm
	Temp. de funcionamiento	-5°C~+35 °C
	Flujo luminoso (lm)	26.588lm
	Vida útil	(L70B50>) 50.000h

Referencias





	W	ϕ_{LUM}	K		
576765	160W	26.588lm	3.000K	Gris lona	303x439x60mm

Dimensiones

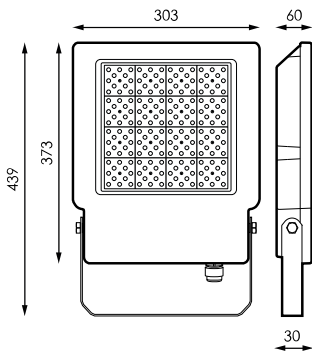

Fotometría



Info	
Protector contra sobretensiones:	