















Spécifications (Luminaires de la série)

	Isolation électrique	CI
	Tension D` Alimentation (V)	230V
Hz	Fréquence (Hz)	50-60Hz
	Indice d'étanchéité IP	IP65
	IK Protection contre des impacts	IK08
	Couleur du corps	Toile grise
	Matériau du diffuseur	VT-T
	Corps	AL
K	Température de couleur	3.000K
	CRI Indice de rendu des couleurs	>70
	Angle d'ouverture	90°
	Dimensions	376x533x66mm
	Température de service	-5°C~+35 °C
	Flux (lm)	34.017lm
	Heures de vie	(L70B50>) 50.000h

Les références



	W	ϕ_{LUM}	K		
576789	200W	34.017lm	3.000K	Toile grise	376x533x66mm

Dimensions

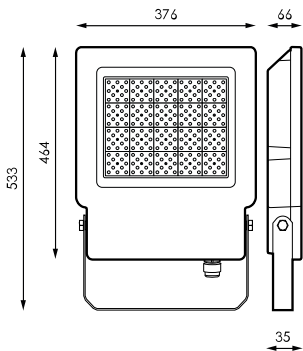

Photométrie



Info



Protecteur de surtension