















Specifications (Series luminaires)

	Electrical isolation	CI
	Voltage (V)	230V
Hz	Frecuency (Hz)	50-60Hz
	IP Tightness index	IP65
	IK Impact resistance	IK08
	Body color	Canvas grey
	Diffuser Material	VT-T
	Body	AL
K	Colour temperature	5.000K
	CRI Colour rendering index	>70
	Opening angle	90°
	Measures	376x533x66mm
	Operating temperature	-5°C~+35 °C
	Flux (lm)	34.860lm
	Lifetime	(L70B50>) 50.000h

References

	W	ϕ_{LUM}	K		
576796	200W	34.860lm	5.000K	Canvas gray	376x533x66mm

Dimensions

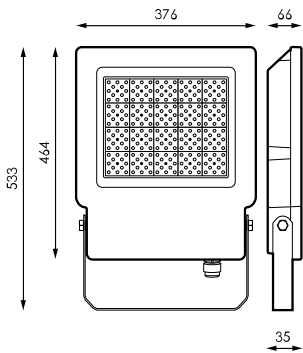

Photometry

Info	
Surge protector	