















Especificações (Luminárias da série)



	Isolamento elétrico	CII
	Tensão (V)	220-240V
Hz	Frequência (Hz)	50-60Hz
	Regulação	Sim
	Índice de estanqueidade IP	IP20
	Cor do corpo	9006
	Corpo	PC
K	Temperatura de cor	3.000K
	CRI Índice de repr. cromática	>80
	Angulo de abertura	38°
	Dimensão	Ø90x44mm
	Posição de montagem	Empotrar
	Inclinação	25°
	Fluxo (lm)	677lm
	Vida	(L70B50>) 25.000h

Referências

	W	ϕ_{LUM}	K					
587587	7W	677lm	3.000K	>80	Cinza 9006	70mm	Ø90x44mm	Si

Dimensões

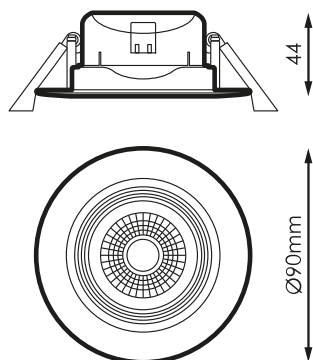

Fotometria

