



















## Especificaciones (Luminarias de Serie)

	<b>Tensión (V)</b>	230V
	<b>Frecuencia (Hz)</b>	50-60Hz
	<b>Factor de potencia (Cos fi)</b>	>0,5
	<b>Regulación</b>	No
	<b>Casquillo</b>	GU10
	<b>IP Índice de estanqueidad</b>	IP20
	<b>Color cuerpo</b>	Blanco
	<b>Difusor</b>	PC-O
	<b>Temperatura de color</b>	4.000K
	<b>CRI Índice de repr. cromática</b>	>80
	<b>Ángulo de apertura</b>	38°
	<b>Dimensiones</b>	50x58mm
	<b>Temp. de funcionamiento</b>	-5°C~+35 °C
	<b>Flujo luminoso (lm)</b>	600lm
	<b>Vida útil</b>	(L70B50>) 25.000h
	<b>CEE Clasificación energética</b>	F



## Referencias



	W	$\phi$	$\phi_{LUM}$	K	$\leftrightarrow$
<b>595322</b>	6,5W	>0,5	600lm	4.000K	50x58mm

## Dimensiones



## Fotometría

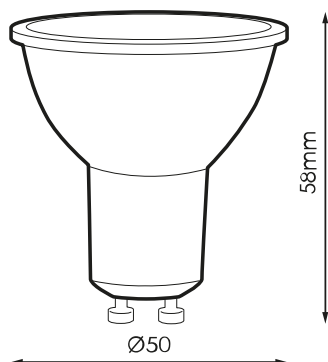

---

## Accesorios

---



---

**974851**

---

PORTALAMPARA  
GU10/GZ10 CON  
CABLE SILICONA