













Especificaciones (Luminarias de Serie)



	Aislamiento eléctrico	CCII
	Tensión (V)	220-240V
Hz	Frecuencia (Hz)	50-60Hz
	IP Índice de estanqueidad	IP20
	Difusor	PC
	Cuerpo	AL iap
	Dimensiones	250x223xØ80mm
	Temp. de funcionamiento	(-30°C,+35°C)
	Flujo luminoso (lm)	3128lm
	Vida útil	>50.000h
	Vida útil	(L70B50>)30.000h

Referencias



	W	ϕ_{LUM}	
627894	30W	3128lm	250x223x ϕ 80mm

Dimensiones

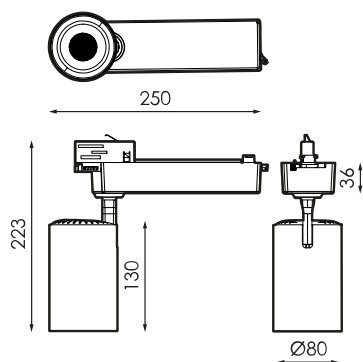

Fotometría





Accesorios



484633

ACCESORIO CHIO
30W NG OVAL
SNOOT



484572

LENTE CHIO 24° 30W