













## Spécifications (Luminaires de la série)

	<b>Isolation électrique</b>	CCII
	<b>Tension D`Alimentation (V)</b>	220-240V
<b>Hz</b>	<b>Fréquence (Hz)</b>	50-60Hz
	<b>Indice d'étanchéité IP</b>	IP20
	<b>Matériau du diffuseur</b>	PC
	<b>Corps</b>	AL iap
	<b>Dimensions</b>	250x223xØ80mm
	<b>Température de service</b>	(-30°C,+35°C)
	<b>Flux (lm)</b>	3128lm
	<b>Heures de vie</b>	>50.000h
	<b>Heures de vie</b>	(L70B50>)30.000h

## Les références

	W	$\phi_{LUM}$	
<b>627894</b>	30W	3128lm	250x223x $\phi$ 80mm

## Dimensions

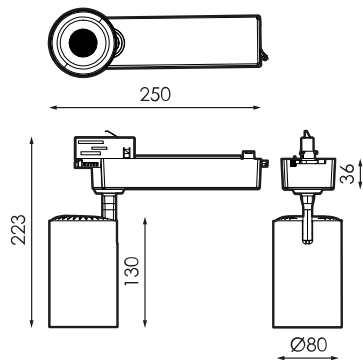

## Photométrie





## Accessoires



**484633**

ACCESSOIRE CHIO  
30W NG OVAL  
SNOOT



**484572**

LENTILLE CHIO 24°  
30W