













Specifications (Series luminaires)

	Electrical isolation	CI
	Voltage (V)	230V
	Dimming	No
	IP Tightness index	IP65
	Diffuser Material	VT-T
	Body	AL
K	Colour temperature	3.000K/4.000K
	Measures	Ø63x323mm
	Mounting position	Superficie
	Operating temperature	-10 +35
	Flux (lm)	411lm
	Lifetime	(L70B50>) 30.000h



References



	W	ϕ_{LUM}	K		
495264	6W	398lm	3.000K	(L70B50>) 30.000h	Ø63x323mm
495271	6W	411lm	4.000K	(L70B50>) 30.000h	Ø63x323mm

Dimensions

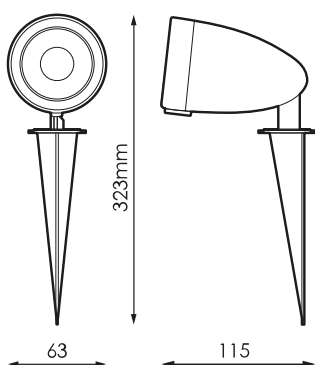

Photometry

