













## Spécifications (Luminaires de la série)

	<b>Isolation électrique</b>	CI
	<b>Tension D`Alimentation (V)</b>	230V
	<b>Atténuation</b>	Non
	<b>Indice d'étanchéité IP</b>	IP65
	<b>Matériau du diffuseur</b>	VT-T
	<b>Corps</b>	AL
<b>K</b>	<b>Température de couleur</b>	3.000K/4.000K
	<b>Dimensions</b>	Ø63x323mm
	<b>Position de montage</b>	Superficie
	<b>Température de service</b>	-10 +35
	<b>Flux (lm)</b>	411lm
	<b>Heures de vie</b>	(L70B50>) 30.000h



## Les références



	W	$\phi_{LUM}$	K		
<b>495264</b>	6W	398lm	3.000K	(L70B50>) 30.000h	Ø63x323mm
<b>495271</b>	6W	411lm	4.000K	(L70B50>) 30.000h	Ø63x323mm

## Dimensions

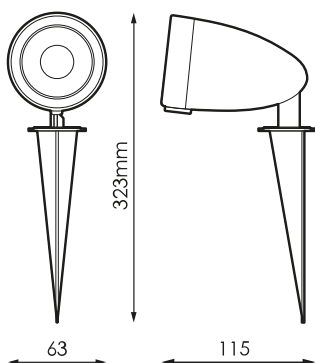

## Photométrie

