











## Spécifications (Luminaires de la série)



	<b>Isolation électrique</b>	CII
	<b>Tension D`Alimentation (V)</b>	220-240V
	<b>Angle d'ouverture</b>	36°
	<b>Dimensions</b>	Ø80x250x223mm
	<b>Flux (lm)</b>	3.128lm
	<b>Heures de vie</b>	30.000h
	<b>Heures de vie</b>	(L70B50>)30.000h

## Les références



	W	$\phi_{LUM}$	
<b>580182</b>	27W	3.059lm	Ø80x250x223mm
<b>580199</b>	27W	3.128lm	Ø80x250x223mm
<b>580205</b>	27W	3.059lm	Ø80x250x223mm
<b>580212</b>	27W	3.128lm	Ø80x250x223mm

## Dimensions

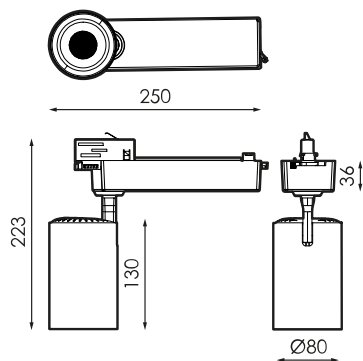

## Photométrie

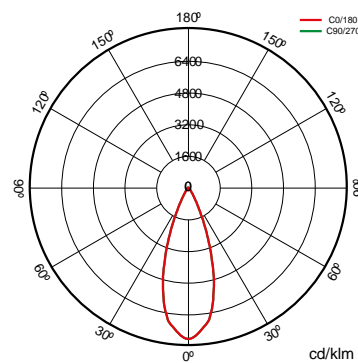



## Accessoires



**484633**

ACCESSOIRE CHIO  
30W NG OVAL  
SNOOT



**484572**

LENTILLE CHIO 24°  
30W



## Info



Rail électrique triphasé et accessoires en blanc, noir et gris. Adaptateur pour le montage à trois phases voies 250V 6A.