

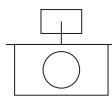

Applications

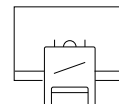

Bureaux



Salles de classe



Vente au détail



Accueil

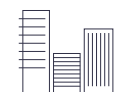

Grandes surfaces











Hôtels









Restaurants

Spécifications (Luminaire de la série)



	Tension D` Alimentation (V)	230V
Hz	Fréquence (Hz)	50-60Hz
	Atténuation	Non
	Indice d'étanchéité IP	IP20
	Couleur du corps	Blanc
	Corps	AL
K	Température de couleur	3.000K/3.000K
	CRI Indice de rendu des couleurs	>80
	Optique	PC
	Angle d'ouverture	90°
	UGR	<19

	Dimensions	1.195x295x14,5mm
	Position de montage	Empotrar
	Température de service	-5°C~+35 °C
	Flux (lm)	3.725/4.164lm
	Isolation électrique	CII
	Heures de vie	(L70B50>) 50.000h

Prilux garantit une tolérance de $\pm 10\%$ dans les mesures de flux lumineux.

Dimensions

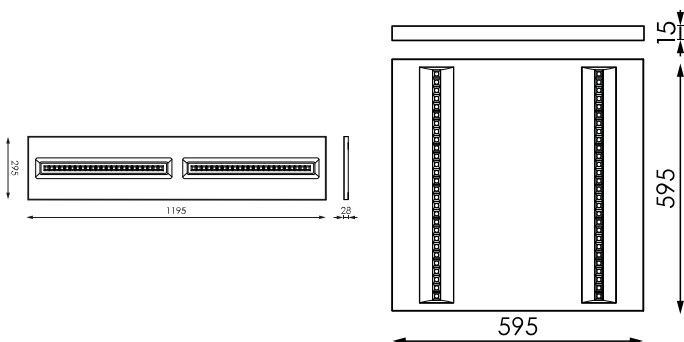



Les références



	W _{LED}	W		ϕ _{LED}	ϕ _{LUM}	K		
496360	35W	32W	850mA	4.678/4.986lm	3.725/4.164lm	3.000K,4.000K	575 x 575	Non
496377	35W	32W	850mA	4.678/4.986lm	3.725/4.164lm	3.000K,4.000K	1.175 x 275	Non

Accessoires



207591

CADRE POUR
ENCASTRER BL
PLAFOND PLACO
SILENT LED
1200X300MM

207874

CADRE SAILLIE
SILENT LED
1200X300MM

491532

KIT SUSPENSION
DIANE TECH 1,5M



Solutions

S



Pack CTE

la description

Règlement pour l'apport de lumière naturelle pour se conformer aux exigences du CTE. Commande indépendante de deux lignes de luminaires DALI gradables avec capteur à installer dans un luminaire ou un boîtier de surface. Préconfiguré pour une utilisation facile.



Pack SALLES

la description

Régulation par apport de lumière naturelle et présence autonome. Système de contrôle de l'éclairage pour répondre aux exigences du CTE et optimiser la consommation d'énergie en profitant de l'apport de lumière naturelle et d'un arrêt automatique en cas d'absence.



Pack BLUETOOTH

la description

Dispositif qui permet le contrôle du luminaire DALI via n'importe quel terminal Bluetooth® via une APP gratuite qui nous offre le contrôle de la régulation du débit, de la couleur, de la configuration de la scène, du comportement lié aux horaires.

Info

Pour plus d'informations sur les différentes solutions compatibles avec ce luminaire, consultez les codes BIDI suivants ou sur le web www.prilux.es