

















## Specifications (Series luminaires)



	<b>Electrical isolation</b>	CI
	<b>Voltage (V)</b>	230V
<b>Hz</b>	<b>Frecuency (Hz)</b>	50-60Hz
	<b>IP Tightness index</b>	IP65
	<b>IK Impact resistance</b>	IK08
	<b>Body color</b>	Canvas grey
	<b>Diffuser Material</b>	VT-T
	<b>Body</b>	AL
<b>K</b>	<b>Colour temperature</b>	3.000K/5.000K
	<b>CRI Colour rendering index</b>	>70
	<b>Opening angle</b>	90°
	<b>Measures</b>	245x365x52mm
	<b>Operating temperature</b>	-5°C~+35 °C
	<b>Flux (lm)</b>	14.594lm
	<b>Lifetime</b>	(L70B50>) 30.000h

## References

	W	$\phi_{LUM}$	K		
<b>576680</b>	13,5W	2.040lm	3.000K	Canvas gray	118x184x35mm
<b>576697</b>	13,5W	2.126lm	5.000K	Canvas gray	118x184x35mm
<b>576703</b>	33W	5.072lm	3.000K	Canvas gray	172x264x45mm
<b>576710</b>	33W	5.134lm	5.000K	Canvas gray	172x264x45mm
<b>576727</b>	50W	8.277lm	3.000K	Canvas gray	217x331x45mm
<b>576734</b>	50W	8.503lm	5.000K	Canvas gray	217x331x45mm
<b>576741</b>	90W	14.369lm	3.000K	Canvas gray	245x365x52mm
<b>576758</b>	90W	14.594lm	5.000K	Canvas gray	245x365x52mm
<b>576765</b>	160W	26.588lm	3.000K	Canvas gray	303x439x60mm
<b>576772</b>	160W	27.433lm	5.000K	Canvas gray	303x439x60mm
<b>576789</b>	200W	34.017lm	3.000K	Canvas gray	376x533x66mm
<b>576796</b>	200W	34.860lm	5.000K	Canvas gray	376x533x66mm

## Dimensions

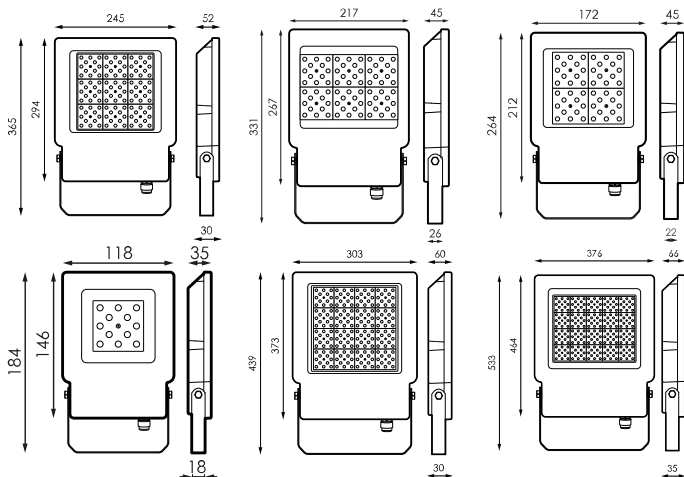

## Photometry

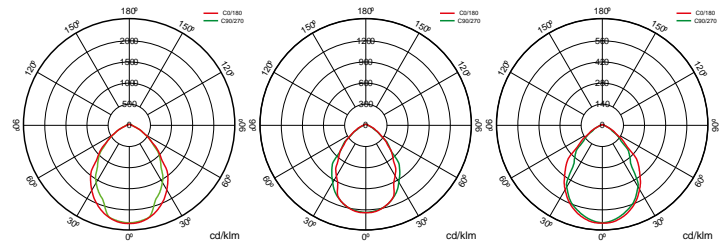



## Info



Surge protector