



















Spécifications (Luminaires de la série)

	Isolation électrique	CI
	Tension D` Alimentation (V)	230V
Hz	Fréquence (Hz)	50-60Hz
	Indice d'étanchéité IP	IP65
	IK Protection contre des impacts	IK08
	Couleur du corps	Toile grise
	Matériau du diffuseur	VT-T
	Corps	AL
K	Température de couleur	3.000K/5.000K
	CRI Indice de rendu des couleurs	>70
	Angle d'ouverture	90°
	Dimensions	245x365x52mm
	Température de service	-5°C~+35 °C
	Flux (lm)	14.594lm
	Heures de vie	(L70B50>) 30.000h

Les références



	W	ϕ_{LUM}	K		
576680	13,5W	2.040lm	3.000K	Toile grise	118x184x35mm
576697	13,5W	2.126lm	5.000K	Toile grise	118x184x35mm
576703	33W	5.072lm	3.000K	Toile grise	172x264x45mm
576710	33W	5.134lm	5.000K	Toile grise	172x264x45mm
576727	50W	8.277lm	3.000K	Toile grise	217x331x45mm
576734	50W	8.503lm	5.000K	Toile grise	217x331x45mm
576741	90W	14.369lm	3.000K	Toile grise	245x365x52mm
576758	90W	14.594lm	5.000K	Toile grise	245x365x52mm
576765	160W	26.588lm	3.000K	Toile grise	303x439x60mm
576772	160W	27.433lm	5.000K	Toile grise	303x439x60mm
576789	200W	34.017lm	3.000K	Toile grise	376x533x66mm
576796	200W	34.860lm	5.000K	Toile grise	376x533x66mm

Dimensions

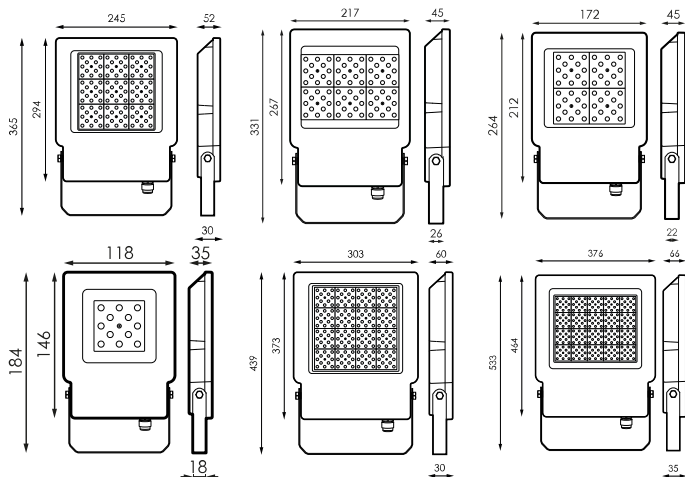

Photométrie

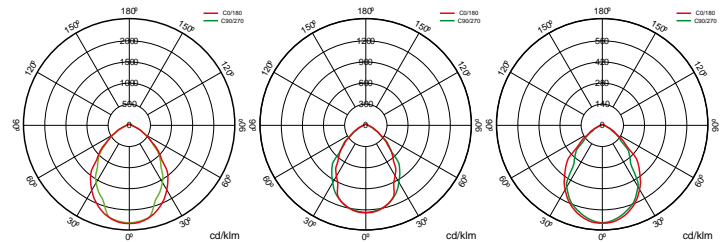



Info



Protecteur de surtension