















Specifications

	Voltage (V)	230V ac
Hz	Frecuency (Hz)	50-60
	IP Tightness index	65
	Diffuser Material	PC-P
	Body	AL
K	Colour temperature	3.000K
	CRI Colour rendering index	>80
	Opening angle	100°
	Measures	158x134x28
	Operating temperature	-5°C~+35 °C
	Flux (lm)	1.438
	Electrical isolation	I
	Lifetime	(L70B50>) 25.000h

References

	W	ϕ_{LUM}	K	
468350	20W	1.438	3.000K	158x134x28

Dimensions

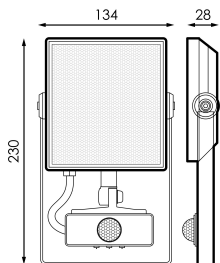

Photometry

Info

Until end of stock