













## Spécifications (Luminaires de la série)

	<b>Tension D` Alimentation (V)</b>	230V
Hz	<b>Fréquence (Hz)</b>	50-60Hz
$\Phi$	<b>Facteur de puissance (Cos fi)</b>	Hasta >0,5
	<b>Atténuation</b>	Non
	<b>Type de bague</b>	GU10
	<b>Indice d'étanchéité IP</b>	IP20
K	<b>Température de couleur</b>	3.000K-5.000K
	<b>CRI Indice de rendu des couleurs</b>	>80
	<b>Angle d'ouverture</b>	100°
	<b>Dimensions</b>	50x58mm
	<b>Température de service</b>	-5°C~+35 °C
$\Phi_{LUM}$	<b>Flux (lm)</b>	622lm
	<b>Heures de vie</b>	(L70B50>) 25.000h
	<b>CEE Classificatio no énergétique</b>	F

## Les références



	W	$\phi$	$\phi_{LUM}$	K	$\leftrightarrow$
<b>378727</b>	7W	>0,5	578lm	3.000K	50x58mm
<b>378734</b>	7W	>0,5	622lm	5.000K	50x58mm
<b>386326</b>	7W	>0,5	605lm	4.000K	50x58mm
<b>595315</b>	6,5W	>0,5	600lm	3.000K	50x58mm
<b>595322</b>	6,5W	>0,5	600lm	4.000K	50x58mm
<b>595339</b>	6,5W	>0,5	600lm	5.000K	50x58mm

## Dimensions



## Photométrie

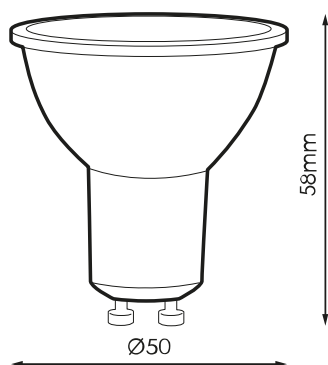



---

## Accessoires

---



---

**974851**

---

DOUILLE HALOG. GU/  
GZ10 C/C SILICONE