



Aplicaciones



Perímetros











Grandes alturas



Grandes Superficies

Especificaciones (Luminarias de Serie)



	Tensión (V)	220-240V
	Intensidad (A)	max.4760mA
Φ	Factor de potencia (Cos fi)	Hasta $\geq 0,9$
	Regulación	DALI
	IP Índice de estanqueidad	IP65
	IK Protección contra impactos	IK10
	Color cuerpo	Negro
	Difusor	PC
	Cuerpo	AL
K	Temperatura de color	4.000K/5.000K
	CRI Índice de repr. cromática	≥ 80

	Dimensiones	$\varnothing 360 \times 189 \text{mm}$
	Peso	5.7Kg
	Temp. de funcionamiento	-30 +35
	Flujo luminoso (lm)	27412lm
	Aislamiento eléctrico	CI
	Vida útil	(L70 B50>)50.000h

Prilux garantiza una tolerancia $\pm 10\%$ en las medidas de flujo lumínico.

Dimensiones

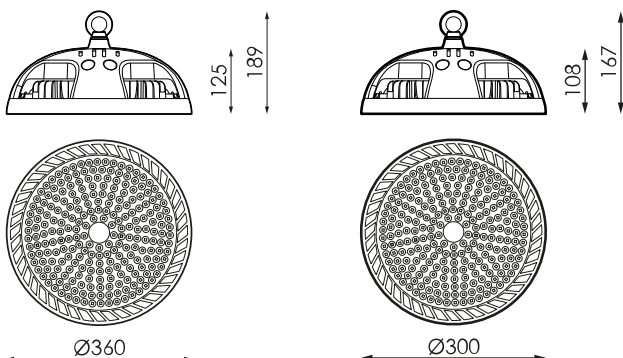



Referencias



	W _{LED}	W		ϕ_{LED}	ϕ_{LUM}	Δ	K		
469388	92W	100W	2280mA	14313lm	13680lm	120°	4.000K	≥80	Ø300x167m
469395	92W	100W	2280mA	14877lm	13985lm	120°	5.000K	≥80	Ø300x167m
469401	138W	150W	3570mA	22178lm	20737lm	120°	4.000K	≥80	Ø300x167m
469418	138W	150W	3570mA	22597lm	21034lm	120°	5.000K	≥80	Ø300x167m
469425	186W	200W	4760mA	29301lm	27412lm	120°	4.000K	≥80	Ø360x189m
469432	186W	200W	4760mA	29808lm	28019lm	120°	5.000K	≥80	Ø360x189m

Bajo Pedido



Óptica Policarbonato de 90°

Óptica Policarbonato de 60°



Bluetooth



Cora Industry

descripción



El dispositivo CORA en sus tres versiones; INDUSTRY UNIT, INDUSTRY y CORA INDUSTRY MASTER controla la iluminación de instalaciones nuevas o incluso ya existentes gracias a una tecnología inalámbrica como es BLUETOOTH 5.0

Info



Para obtener más información de las diferentes soluciones compatibles con esta luminaria consulte en los siguientes códigos BIDI o en la web www.prilux.es



Normas



El montaje del reflector y ópticas conlleva una reducción del flujo del 4%. Este producto se sirve con 2 mangueras incorporadas de 250mm.



Info



El montaje del reflector conlleva una reducción del flujo del 4%.
Este producto se sirve con 2 mangueras incorporadas de 250mm.