



Formulários



Perímetros











Grandes alturas









Grandes superfícies

Especificações (Luminárias da série)



	Tensão (V)	220-240V
	Intensidade (A)	max.4760mA
Φ	Fator de Potência (Cos fi)	Hasta -
	Regulação	DALI
	Índice de estanqueidade IP	IP65
	IK Proteção contra impactos	IK10
	Cor do corpo	Preto
	Material Difusor	PC
	Corpo	AL
K	Temperatura de cor	4000K-5.000K
	CRI Índice de repr. cromática	≥80

	Dimensão	Ø360x189mm
	Peso	5.7Kg
	Temperatura de trabalho	-30 +35
	Fluxo (lm)	27412lm
	Isolamento elétrico	CI
	Vida	(L70 B50>)50.000h

Prilux garante uma tolerância de $\pm 10\%$ nas medições de fluxo de luz.

Dimensões

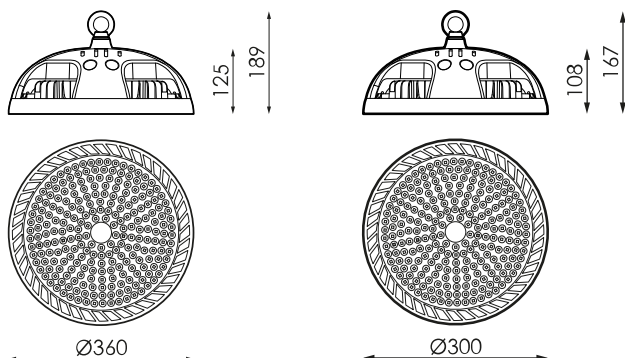



Referências



	W_{LED}	W	ϕ_{LED}	ϕ_{LUM}	Δ	\leftrightarrow
469388	92W	100W	2280mA	14313lm	13680lm	120°
469395	92W	100W	2280mA	14877lm	13985lm	120°
469401	138W	150W	3570mA	22178lm	20737lm	120°
469418	138W	150W	3570mA	22597lm	21034lm	120°
469425	186W	200W	4760mA	29301lm	27412lm	120°
469432	186W	200W	4760mA	29808lm	28019lm	120°
469531	-	-W	-lm	-lm	-	0mm
469548	-	-W	-lm	-lm	-	0mm

A pedido



Ótica de policarbonato 50°-90°

Óptica de policarbonato 60°-90°



Bluetooth



Acessórios



469548

KIT LIRA KELA 200W



Cora Industry

descrição



O dispositivo CORA em suas três versões; INDUSTRY UNIT, INDUSTRY e CORA INDUSTRY MASTER controlam a iluminação de instalações novas ou existentes, graças à tecnologia sem fio como BLUETOOTH 5.0

Informacje



Para mais informações sobre as diferentes soluções compatíveis com esta luminária, consulte os seguintes códigos BIDI ou na web www.prilux.es



Regras



O conjunto reflector e óptica fluxo conduz a uma redução de 4%.
Este produto é utilizado com 2 mangueiras construídas 250 mm.



Informacje



O conjunto reflector fluxo conduz a uma redução de 4%. Este produto é utilizado com 2 mangueiras construídas 250 mm.