















## Especificaciones (Luminarias de Serie)

	<b>Aislamiento eléctrico</b>	CI
	<b>Tensión (V)</b>	230V
<b>Hz</b>	<b>Frecuencia (Hz)</b>	50-60Hz
	<b>Factor de potencia (Cos fi)</b>	Hasta >0,9
	<b>IP Índice de estanqueidad</b>	IP65
	<b>Color cuerpo</b>	7045
	<b>Difusor</b>	VT-O
	<b>Cuerpo</b>	AL
<b>K</b>	<b>Temperatura de color</b>	3.000K/5.000K
	<b>CRI Índice de repr. cromática</b>	>80
	<b>Ángulo de apertura</b>	100°
	<b>Dimensiones</b>	109x90x27mm
	<b>Flujo luminoso (lm)</b>	911lm
	<b>Vida útil</b>	(L70B50>) 25.000h

## Referencias



	W	$\phi_{LUM}$	K		
<b>504638</b>	10W	911lm	3.000K	RAL7045	109x90x27mm
<b>504645</b>	10W	987lm	5.000K	RAL7045	109x90x27mm
<b>504652</b>	20W	1.823lm	3.000K	RAL7045	165x135x30mm
<b>504669</b>	20W	1.923lm	5.000K	RAL7045	165x135x30mm
<b>504676</b>	30W	2.618lm	3.000K	RAL7045	186x135x30mm
<b>504683</b>	30W	2.743lm	5.000K	RAL7045	186x135x30mm
<b>504690</b>	50W	4.371lm	3.000K	RAL7045	240x180x30mm
<b>504706</b>	50W	4.516lm	5.000K	RAL7045	240x180x30mm
<b>504713</b>	70W	6.203lm	3.000K	RAL7045	287x243x37mm
<b>504720</b>	70W	6.318lm	5.000K	RAL7045	287x243x37mm
<b>504737</b>	100W	8.711lm	3.000K	RAL7045	313x243x37mm
<b>504744</b>	100W	8839lm	5.000K	RAL7045	313x243x37mm
<b>522533</b>	30W	2.743lm	5.000K	Blanco	186x135x30mm
<b>522540</b>	50W	4.516lm	5.000K	Blanco	240x180x30mm

## Dimensiones

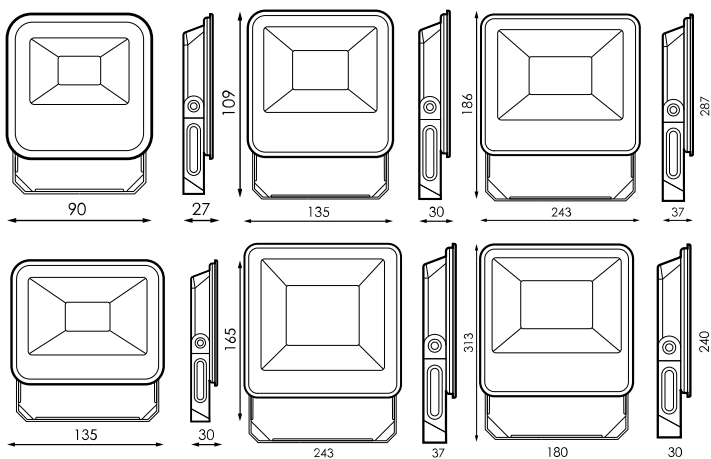

## Fotometría

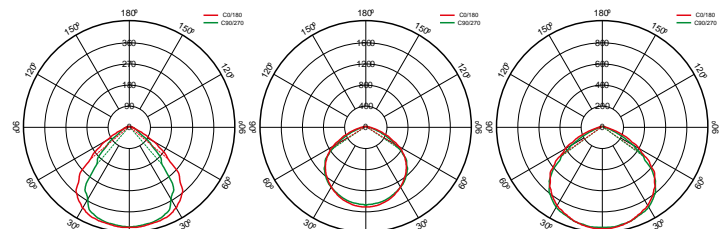

## Info



Hasta fin de existencias