















## Spécifications (Luminaires de la série)

	<b>Isolation électrique</b>	CI
	<b>Tension D` Alimentation (V)</b>	230V
<b>Hz</b>	<b>Fréquence (Hz)</b>	50-60Hz
	<b>Facteur de puissance (Cos fi)</b>	Hasta >0,5
	<b>Indice d'étanchéité IP</b>	IP65
	<b>Couleur du corps</b>	7045
	<b>Matériau du diffuseur</b>	VT-O
	<b>Corps</b>	AL
<b>K</b>	<b>Température de couleur</b>	3.000K/5.000K
	<b>CRI Indice de rendu des couleurs</b>	>80
	<b>Angle d'ouverture</b>	110°
	<b>Dimensions</b>	186x135x30mm
	<b>Flux (lm)</b>	2.743lm
	<b>Heures de vie</b>	(L70B50>) 25.000h

## Les références

	W	$\phi_{LUM}$	K		
<b>504638</b>	10W	911lm	3.000K	Gris foncé	109x90x27mm
<b>504645</b>	10W	987lm	5.000K	Gris foncé	109x90x27mm
<b>504652</b>	20W	1.823lm	3.000K	Gris foncé	165x135x30mm
<b>504669</b>	20W	1.923lm	5.000K	Gris foncé	165x135x30mm
<b>504676</b>	30W	2.618lm	3.000K	Gris foncé	186x135x30mm
<b>504683</b>	30W	2.743lm	5.000K	Gris foncé	186x135x30mm
<b>504690</b>	50W	4.371lm	3.000K	Gris foncé	240x180x30mm
<b>504706</b>	50W	4.516lm	5.000K	Gris foncé	240x180x30mm
<b>504713</b>	70W	6.203lm	3.000K	Gris foncé	287x243x37mm
<b>504720</b>	70W	6.318lm	5.000K	Gris foncé	287x243x37mm
<b>504737</b>	100W	8.711lm	3.000K	Gris foncé	313x243x37mm
<b>504744</b>	100W	8839lm	5.000K	Gris foncé	313x243x37mm
<b>522533</b>	30W	2.743lm	5.000K	Blanc	186x135x30mm
<b>522540</b>	50W	4.516lm	5.000K	Blanc	240x180x30mm

## Dimensions

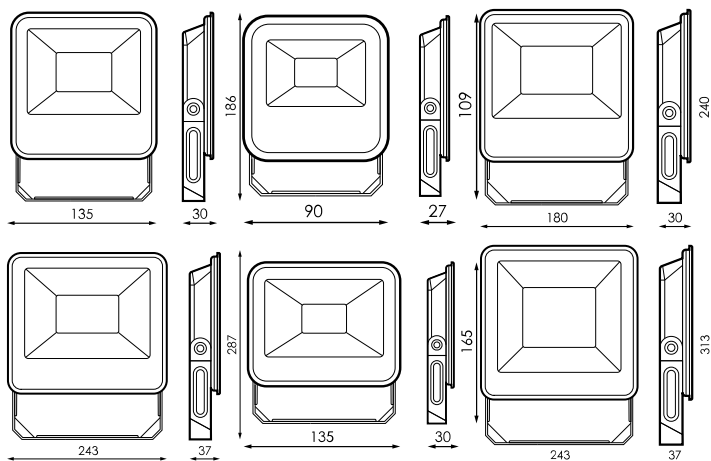

## Photométrie

