







Especificaciones (Luminarias de Serie)

	Aislamiento eléctrico	CII
	Tensión (V)	180-250V
Hz	Frecuencia (Hz)	50-60Hz
	Regulación	No
	IP Índice de estanqueidad	IP20
	Color cuerpo	Blanco
	Difusor	PC-O
	Cuerpo	AL
K	Temperatura de color	3.000K/4.000K
	CRI Índice de repr. cromática	>80
	Ángulo de apertura	120°
	Dimensiones	175x30mm
	Posición de montaje	Empotrado Techo
	Temp. de funcionamiento	-5°C~+35 °C
	Flujo luminoso (lm)	1.551lm
	Vida útil	(L70B50>) 50.000h

Referencias



	W	ϕ_{LUM}	K					
381451	14W	1.551lm	4.000K	>80	Gris 9006	150-155	175x30mm	No
381468	14W	1.476lm	3.000K	>80	Gris 9006	150-155	175x30mm	No
381475	14W	1.551lm	4.000K	>80	Blanco	150-155	175x30mm	No
381482	14W	1.476lm	3.000K	>80	Blanco	150-155	175x30mm	No
527309	14W	1.551lm	4.000K	>80	Blanco	150-155	175x30mm	Si
532150	14W	1.551lm	4.000K	>80	Blanco	150-155	175x30mm	Si

Dimensiones



Fotometría

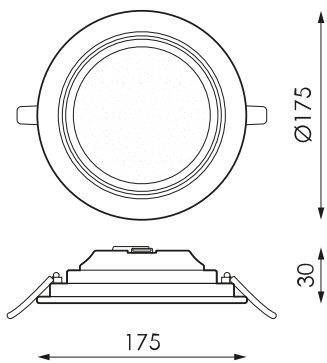

Bajo Pedido



Kit de emergencia 2h



DALI

Accesorios



387569

ACCESORIO
SUPERFICIE CL
KENTAU 14W
BLANCO



532198

DRIVER KENTAU 14W
1-10V



543125

DRIVER KENTAU 14W
CTOUCH



507332

DRIVER KENTAU 14W
DALI



Tecnologías



CELLTECH



La tecnología CELLTECH es un sistema revolucionario de alimentación de luminarias que permite la extracción y el intercambio de drivers que facilita y simplifica la instalación y montaje de luminarias. Los driver CELLTECH están disponibles sin regulación y con regulación 1-10V y C-TOUCH.



Soluciones

S



Pack CTE

descripción



Regulación por aporte de luz natural para cumplir con las exigencias del CTE. Control independiente de dos líneas de luminarias regulables DALI con sensor para instalar en luminaria o caja en superficie. Preconfigurado para poner en funcionamiento de manera sencilla.



Pack BLUETOOTH

descripción



Dispositivo que habilita el control de luminaria DALI a través de cualquier terminal Bluetooth® vía APP gratuita que nos ofrece el control de regulación de flujo, color, configuración de escenas, comportamiento vinculado a horarios.



Pack AULAS

descripción



Regulación por aporte de luz natural y presencia stand alone. Sistema de control de iluminación para cumplir con las exigencias del CTE y optimizar el uso de la energía aprovechando el aporte de luz natural y apagado automático en caso de ausencia.

Info



Para obtener más información de las diferentes soluciones compatibles con esta luminaria consulte en los siguientes códigos BIDI o en la web www.prilux.es