







Spécifications (Luminaires de la série)

	Isolation électrique	CII
	Tension D` Alimentation (V)	180-250V
Hz	Fréquence (Hz)	50-60Hz
	Atténuation	Non
	Indice d'étanchéité IP	IP20
	Couleur du corps	Blanc
	Matériau du diffuseur	PC-O
	Corps	AL
K	Température de couleur	3.000K/4.000K
	CRI Indice de rendu des couleurs	>80
	Angle d'ouverture	120°
	Dimensions	175x30mm
	Position de montage	Empotrado Techo
	Température de service	-5°C~+35 °C
	Flux (lm)	1.476lm
	Heures de vie	(L70B50>) 50.000h

Les références



	W	ϕ_{LUM}	K					
381451	14W	1.551lm	4.000K	>80	Gris 9006	150-155	175x30mm	Non
381468	14W	1.476lm	3.000K	>80	Gris 9006	150-155	175x30mm	Non
381475	14W	1.551lm	4.000K	>80	Blanc	150-155	175x30mm	Non
381482	14W	1.476lm	3.000K	>80	Blanc	150-155	175x30mm	Non
527309	14W	1.551lm	4.000K	>80	Blanc	150-155	175x30mm	Oui
532150	14W	1.551lm	4.000K	>80	Blanc	150-155	175x30mm	Oui

Dimensions



Photométrie

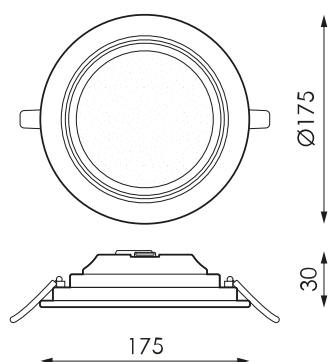

Sur demande



Kit d'urgence 2h



Dali

Accessoires



387569

ACCÉSSOIRE SAILLIE
CIRCULAIRE KENTAOU
14W BLANC



532198

DRIVER KENTAOU 14W
1-10V



543125

DRIVER KENTAOU 14W
CTOUCH



507332

DRIVER KENTAOU 14W
DALI PRILUX



Les technologies



CELLTECH



La technologie CELLTECH est un système d'alimentation révolutionnaire pour luminaires qui permettent l'extraction et l'échange de pilotes qui facilite et simplifie l'installation et le montage des luminaires. Les drivers CELLTECH sont disponibles sans régulation et avec régulation 1-10V et C-TOUCH.



Solutions

S



Pack CTE

la description

Règlement pour l'apport de lumière naturelle pour se conformer aux exigences du CTE. Commande indépendante de deux lignes de luminaires DALI gradables avec capteur à installer dans un luminaire ou un boîtier de surface. Préconfiguré pour une utilisation facile.



Pack SALLES

la description

Régulation par apport de lumière naturelle et présence autonome. Système de contrôle de l'éclairage pour répondre aux exigences du CTE et optimiser la consommation d'énergie en profitant de l'apport de lumière naturelle et d'un arrêt automatique en cas d'absence.



Pack BLUETOOTH

la description

Dispositif qui permet le contrôle du luminaire DALI via n'importe quel terminal Bluetooth® via une APP gratuite qui nous offre le contrôle de la régulation du débit, de la couleur, de la configuration de la scène, du comportement lié aux horaires.

Info

Pour plus d'informations sur les différentes solutions compatibles avec ce luminaire, consultez les codes BIDI suivants ou sur le web www.prilux.es