













## Especificações (Luminárias da série)

	<b>Isolamento elétrico</b>	CII
	<b>Tensão (V)</b>	180-250V
<b>Hz</b>	<b>Frequência (Hz)</b>	50-60Hz
$\Phi$	<b>Fator de Potência (Cos fi)</b>	Hasta $\geq 0,9$
	<b>Regulação</b>	1-10V
	<b>Índice de estanqueidade IP</b>	IP20
	<b>Cor do corpo</b>	Branco
	<b>Material Difusor</b>	PC-O
	<b>Corpo</b>	AL
<b>K</b>	<b>Temperatura de cor</b>	3000K-4.000K
	<b>CRI Índice de repr. cromática</b>	>80
	<b>Angulo de abertura</b>	120°
	<b>Dimensão</b>	175x30mm
	<b>Posição de montagem</b>	Empotrar
	<b>Temperatura de trabalho</b>	-5°C~+35 °C
$\Phi_{LUM}$	<b>Fluxo (lm)</b>	1.551lm
	<b>Vida</b>	(L70B50>) 50.000h



## Referências



	W	$\phi_{LUM}$	K			
<b>381451</b>	14W	1596lm	4000K	80cromatica	175x30mm	Não
<b>381468</b>	14W	1516lm	3000K	80cromatica	175x30mm	Não
<b>381475</b>	14W	1.551lm	4.000K	>80	Branco	150-155
<b>381482</b>	14W	1.476lm	3.000K	>80	Branco	150-155
<b>527309</b>	14W	1.551lm	4.000K	>80	Branco	150-155
<b>532150</b>	14W	1.551lm	4.000K	>80	Branco	150-155

## Dimensões



## Fotometria

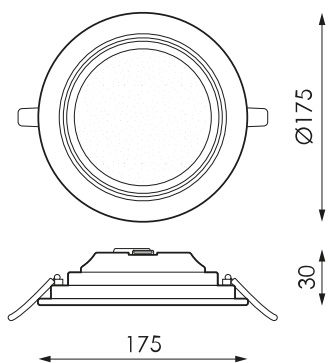



## A pedido



Kit de emergência 2h



Dali

## Acessórios



**387569**

ACESSÓRIO  
SUPERFICIE CL  
KENTAU 14W  
BRANCO



**532198**

DRIVER KENTAU 14W  
1-10V



---

## Tecnologias

---



---

### CELLTECH

---



A tecnologia CELLTECH é um sistema de alimentação revolucionário para luminárias que permitem a extração e troca de drivers que facilita e simplifica a instalação e montagem de luminárias. Os drivers CELLTECH estão disponíveis sem regulação e com regulação de 1-10V e C-TOUCH.

---



## Soluções

S



### Pacote CTE

#### descrição



Regulamento de contribuição da luz natural para atendimento aos requisitos do CTE. Controlo independente de duas linhas de luminárias DALI reguláveis com sensor para instalar numa luminária ou caixa de superfície. Pré-configurado para fácil operação.



### Pacote BLUETOOTH

#### descrição



Dispositivo que permite o controle da luminária DALI através de qualquer terminal Bluetooth® via APP gratuito que nos oferece controle de regulação de fluxo, cor, configuração de cena, comportamento vinculado a horários.



### Pacote SALAS

#### descrição



Regulação por contribuição de luz natural e presença autónoma. Sistema de controle de iluminação para atender aos requisitos do CTE e otimizar o uso de energia, aproveitando o aporte de luz natural e desligamento automático em caso de ausência.

## Informacje



Para mais informações sobre as diferentes soluções compatíveis com esta luminária, consulte os seguintes códigos BIDI ou na web [www.prilux.es](http://www.prilux.es)