













Especificações (Luminárias da série)

	Isolamento elétrico	CII
	Tensão (V)	180-250V
Hz	Frequência (Hz)	50-60Hz
Φ	Fator de Potência (Cos fi)	Hasta $\geq 0,9$
	Regulação	Não
	Índice de estanqueidade IP	IP20
	Cor do corpo	Branco
	Material Difusor	PC-O
	Corpo	AL
K	Temperatura de cor	3.000K-4.000K
	CRI Índice de repr. cromática	>80
	Angulo de abertura	120°
	Dimensão	150x30mm
	Posição de montagem	Empotrado Techo
	Temperatura de trabalho	-5°C~+35 °C
Φ_{LUM}	Fluxo (lm)	996lm
	Vida	(L70B50>) 50.000h



Referências



	W	ϕ_{LUM}	K			
381499	9W	954lm	4000K	80cromatica	150x30mm	Não
381505	9W	996lm	3.000K	>80	Cinza 9006	125-130
381512	9W	1.017lm	4.000K	>80	Branco	125-130
381529	9W	996lm	3.000K	>80	Branco	125-130
532167	9W	954lm	4000K	80cromatica	Branco	150x30mm

Dimensões



Fotometria

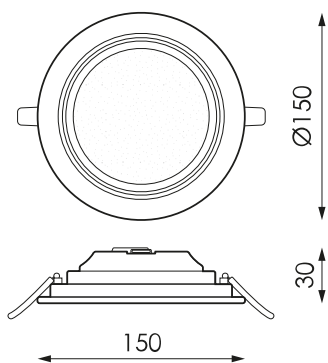



A pedido



Kit de emergência 2h

Acessórios



387545

ACESSÓRIO
SUPERFICIE CL
KENTAU 9W BRANCO



532204

DRIVER KENTAU 9W
1-10V



Tecnologias



CELLTECH



A tecnologia CELLTECH é um sistema de alimentação revolucionário para luminárias que permitem a extração e troca de drivers que facilita e simplifica a instalação e montagem de luminárias. Os drivers CELLTECH estão disponíveis sem regulação e com regulação de 1-10V e C-TOUCH.



Soluções

S



Pacote CTE

descrição



Regulamento de contribuição da luz natural para atendimento aos requisitos do CTE. Controlo independente de duas linhas de luminárias DALI reguláveis com sensor para instalar numa luminária ou caixa de superfície. Pré-configurado para fácil operação.



Pacote BLUETOOTH

descrição



Dispositivo que permite o controle da luminária DALI através de qualquer terminal Bluetooth® via APP gratuito que nos oferece controle de regulação de fluxo, cor, configuração de cena, comportamento vinculado a horários.



Pacote SALAS

descrição



Regulação por contribuição de luz natural e presença autónoma. Sistema de controle de iluminação para atender aos requisitos do CTE e otimizar o uso de energia, aproveitando o aporte de luz natural e desligamento automático em caso de ausência.

Informacje



Para mais informações sobre as diferentes soluções compatíveis com esta luminária, consulte os seguintes códigos BIDI ou na web www.prilux.es