

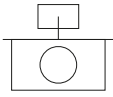

---

## Applications

---



Offices

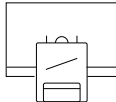

Classrooms



Retail



Home



Large surfaces



Hotels



















Restaurants



Health care

## Specifications (Series luminaires)

 <b>Voltage (V)</b>	220-240V	 <b>Measures</b>	Ø232x112,8mm
<b>Hz Frecuency (Hz)</b>	50-60Hz	 <b>Mounting position</b>	Empotrar
 <b>Current (A)</b>	max.900mA	 <b>Flux (lm)</b>	2.363/2.517lm
 <b>Power factor (Cos fi)</b>	Hasta 0,9	 <b>Electrical isolation</b>	CII
 <b>Dimming</b>	No	 <b>Lifetime</b>	L70>40.000h
 <b>IP Tightness index</b>	IP20		
 <b>IK Impact resistance</b>	IK0		
 <b>Body color</b>	White		
 <b>Diffuser Material</b>	AL-AN		
 <b>Body</b>	AL		
<b>K Colour temperature</b>	3.000K/4.000K/3.000K/4.000K		
 <b>CRI Colour rendering index</b>	>80		
 <b>UGR</b>	UGR <19		

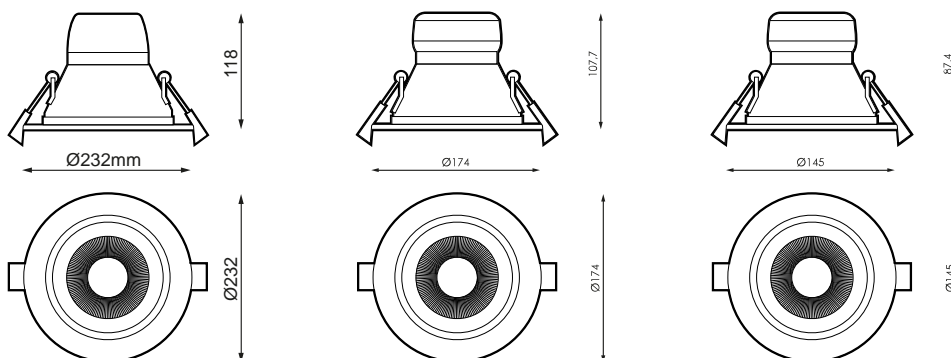

Prilux guarantees a ± 10% tolerance in light flux measurements.

## Dimensions



## References



	W <sub>LED</sub>	W		$\phi_{LED}$	$\phi_{LUM}$	K		
<b>492652</b>	12W	15W	700mA	1.427/1.561lm	1.182/1.249lm	50°	3.000K/4.000K	Ø145
<b>492669</b>	18W	20W	700mA	2.156/2.244lm	1.697/1.818lm	50°	3.000K/4.000K	Ø174
<b>492676</b>	25W	28W	700mA	2.935/3.106lm	2.363/2.517lm	60°	3.000K/4.000K	Ø232
<b>492683</b>	31W	35W	900mA	3.780/4.032lm	2.871/3.185lm	60°	3.000K/4.000K	Ø232
<b>587389</b>	18W	20W	700mA	2.091lm/lm	1.686lm/lm	3.000K/4.000K	Ø174x88,8mm	

## Photometry

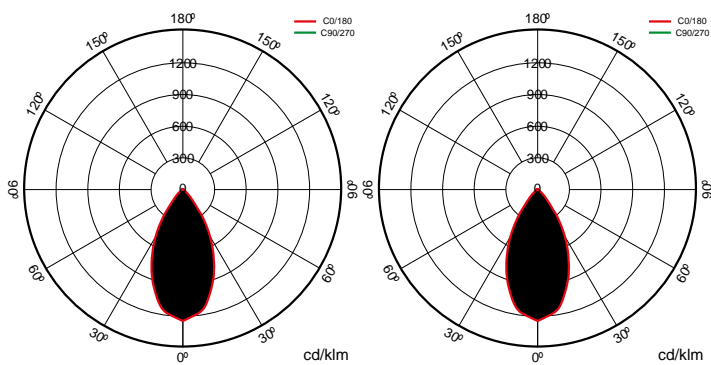

On request



Dali



Bluetooth



Emergency kit





## Solutions

S



### CTE Pack

#### description

Regulation for the contribution of natural light to comply with the requirements of the CTE. Independent control of two lines of dimmable DALI luminaires with sensor to install in a luminaire or surface box. Preconfigured for easy operation.



### CLASSROOMS Pack

#### description

Regulation by contribution of natural light and stand alone presence. Lighting control system to meet CTE requirements and optimize energy use by taking advantage of natural light and automatic shutdown in case of absence.



### Bluetooth package

#### description

Casambi version of our fixtures that enables through any Bluetooth® terminal via free APP that offers the control of flow regulation, color, scene configuration, behavior linked to schedules. Multiple accessories can be configured to work on the same network to unify the control of one or more spaces, being able to create groups, scenes and dynamic sequences to measure. The Bluetooth® device is valid for any DALI luminaire.

#### Info

For more information on the different solutions compatible with this luminaire, consult the following BIDI codes or on the web [www.prilux.es](http://www.prilux.es)



## Info



You need DALI drive