

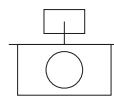

MADE IN SPAIN
Design by PRILUX



Applications



Offices

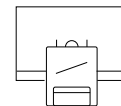

Classrooms



Retail



Home



Large surfaces



Hotels











Restaurants







Health care



Specifications (Series luminaires)

	Voltage (V)	220-240V
Hz	Frecuency (Hz)	50-60Hz
	Current (A)	max.390mA
ϕ	Power factor (Cos fi)	Hasta 0,93
	LED number	72/90
	Dimming	No
	IP Tightness index	IP20
	Body color	9006
	Diffuser Material	AL-SP
	Body	AL
K	Colour temperature	4.000K/4.000K
	CRI Colour rendering index	>80

	Measures	1.414x60x80mm
	Mounting position	Superficie/Suspendido
ϕ_{LUM}	Flux (lm)	2.857lm
	Electrical isolation	CI
	Lifetime	L70>50.000h

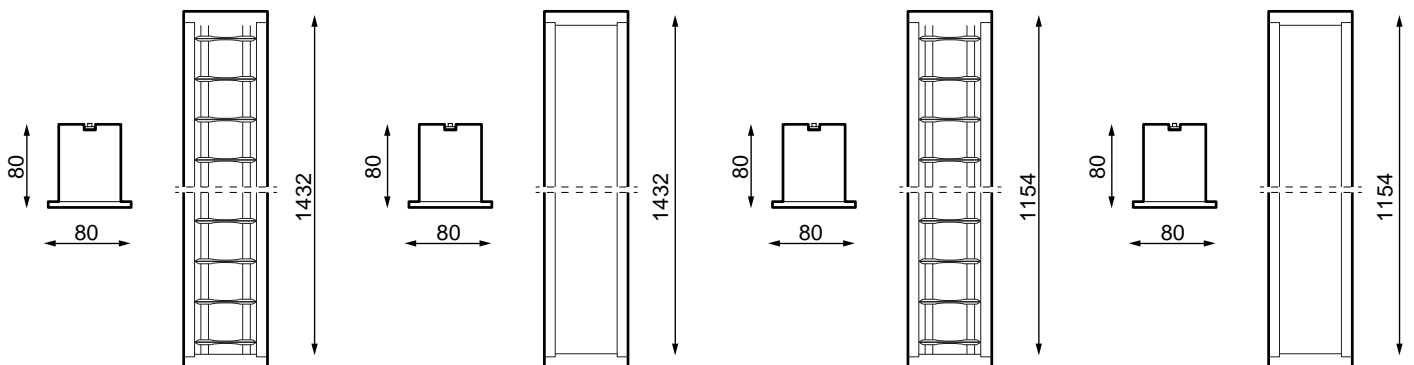

Prilux guarantees a $\pm 10\%$ tolerance in light flux measurements.

Dimensions



References



	W_{LED}	W		ϕ_{LED}	ϕ_{LUM}	K	
538114	30W	32W	390mA	3.945lm	2.286lm	4.000K	1.136x60x80mm
538121	30W	32W	390mA	3.945lm	2.400lm	4.000K	1.136x60x80mm
538138	37W	40W	390mA	4.930lm	2.857lm	4.000K	1.414x60x80mm
538145	37W	40W	390mA	4.930lm	3.000lm	4.000K	1.414x60x80mm

Photometry

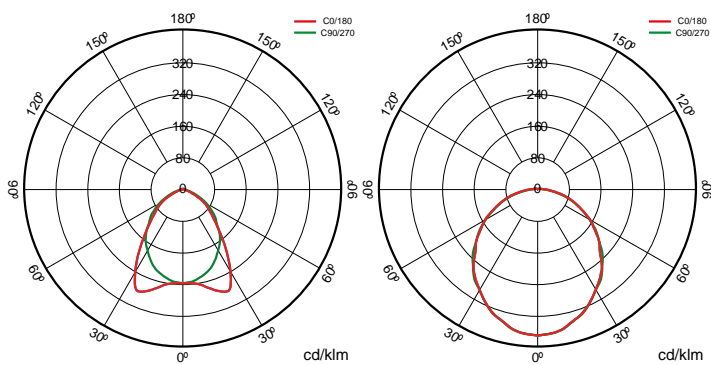

On request



Presence and brightness sensor (mod.
1x/2x 1.200mm/1.500mm)



Dali

Bluetooth

K

WAS(*Not compatible for 37W luminaires)

>80 3.000K

>80 4.000K

>80 4.000K



Available RAL colors (Consult)

Accessories



207638

TRANS POWER
CABLE 3X0.75 1M 1PC



538237

ACCESORIO
SUPERFICIE LYNX



538244

ACCESORIO
SUSPENSION LYNX



537933

ADJUSTABLE
POWER CABLE
TRANS 5X0.75 1M 1PC



Solutions

S



CTE Pack

description

Regulation for the contribution of natural light to comply with the requirements of the CTE. Independent control of two lines of dimmable DALI luminaires with sensor to install in a luminaire or surface box. Preconfigured for easy operation.



CLASSROOMS Pack

description

Regulation by contribution of natural light and stand alone presence. Lighting control system to meet CTE requirements and optimize energy use by taking advantage of natural light and automatic shutdown in case of absence.



Was Indoor

description

The WAS INDOOR solution is specifically aimed at increasing the well-being of users in places such as hospitals, nursing homes, wellness centres, classrooms and offices. The circadian lighting is applied in workplaces to improve visual conditions, comfort and the workers' performance, resulting in a higher productivity and a better development of the company.



Bluetooth package

description

Casambi version of our fixtures that enables through any Bluetooth® terminal via free APP that offers the control of flow regulation, color, scene configuration, behavior linked to schedules. Multiple accessories can be configured to work on the same network to unify the control of one or more spaces, being able to create groups, scenes and dynamic sequences to measure. The Bluetooth® device is valid for any DALI luminaire.

Info

For more information on the different solutions compatible with this luminaire, consult the following BIDI codes or on the web www.prilux.es