















## Especificaciones (Luminarias de Serie)

	<b>Aislamiento eléctrico</b>	CI
	<b>Tensión (V)</b>	100-240V
<b>Hz</b>	<b>Frecuencia (Hz)</b>	50-60Hz
	<b>Regulación</b>	No
	<b>IP Índice de estanqueidad</b>	IP54
	<b>Difusor</b>	VT-T
	<b>Cuerpo</b>	AL
<b>K</b>	<b>Temperatura de color</b>	3.000K/4.000K
	<b>CRI Índice de repr. cromática</b>	≥80
	<b>Ángulo de apertura</b>	80°
	<b>Dimensiones</b>	140x70x71mm
	<b>Posición de montaje</b>	Empotrado Pared
	<b>Temp. de funcionamiento</b>	-10 +35
	<b>Flujo luminoso (lm)</b>	76lm
	<b>Vida útil</b>	(L70B50>) 30.000h



## Referencias



	W	$\phi_{LUM}$	K			$\Delta$	
<b>495288</b>	3W	76lm	3.000K	$\geq 80$	(L70B50>) 30.000h	80°	140x70x71mm
<b>495295</b>	3W	81lm	4.000K	$\geq 80$	(L70B50>) 30.000h	80°	140x70x71mm

## Dimensiones

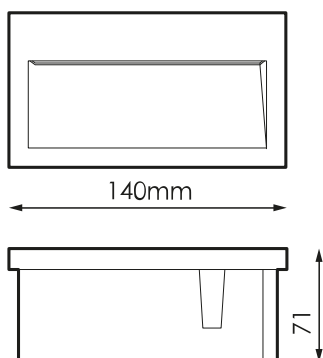

## Fotometría

