











Spécifications (Luminaires de la série)

	Isolation électrique	CI
	Tension D` Alimentation (V)	100-240V
Hz	Fréquence (Hz)	50-60Hz
	Atténuation	Non
	Indice d'étanchéité IP	IP54
	Matériau du diffuseur	VT-T
	Corps	AL
K	Température de couleur	3.000K/4.000K
	CRI Indice de rendu des couleurs	≥80
	Angle d'ouverture	80°
	Dimensions	140x70x71mm
	Position de montage	Empotrado Pared
	Température de service	-10 +35
	Flux (lm)	76lm
	Heures de vie	(L70B50>) 30.000h



Les références



	W	ϕ_{LUM}	K			Δ	
495288	3W	76lm	3.000K	≥ 80	(L70B50>) 30.000h	80°	140x70x71mm
495295	3W	81lm	4.000K	≥ 80	(L70B50>) 30.000h	80°	140x70x71mm

Dimensions

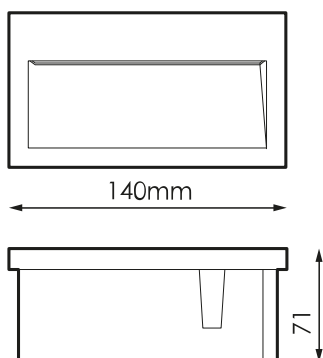

Photométrie

