

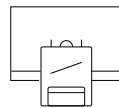

Applications



Classrooms



Retail



Home



Large surfaces











Hotels







Restaurants

Specifications (Series luminaires)



	Voltage (V)	220-240V
Hz	Frecuency (Hz)	50-60Hz
	Current (A)	max.1150mA
ϕ	Power factor (Cos fi)	Hasta 0,96
	Dimming	No
	IP Tightness index	IP44
	Body color	White
	Diffuser Material	VT
	Body	AL
	Reflector	AL AN
K	Colour temperature	3.000K/4.000K

	Measures	Ø190x140mm
	Mounting position	Empotrar
	Inclination	50°/+135°/-135°
ϕ_{LUM}	Flux (lm)	3.359lm
	Electrical isolation	CII
	Lifetime	L70>30.000h

Prilux guarantees a $\pm 10\%$ tolerance in light flux measurements.

Dimensions

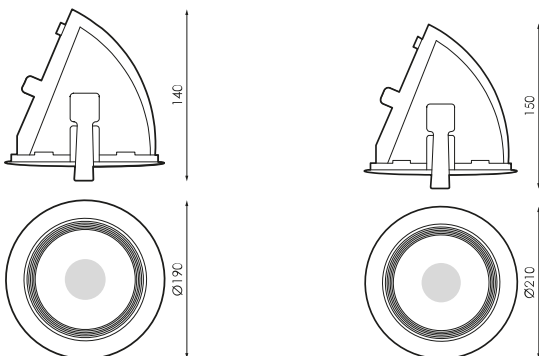



References



	W _{LED}	W		ϕ_{LED}	ϕ_{LUM}	Δ	K	
144049	35W	38W	1050mA	4.046lm	3.667lm	40°	4.000K	Ø190x140mm
144551	35W	38W	1050mA	3.909lm	3.557lm	40°	3.000K	Ø190x140mm
210027	35W	38W	1050mA	3.909lm	3.236lm	100°	3.000K	Ø190x140mm
237963	35W	38W	1050mA	4.046lm	3.359lm	100°	4.000K	Ø190x140mm
381635	50W	52W	1150mA	5.812lm	4.626lm	40°	3.000K	Ø210x150mm
381642	50W	52W	1150mA	5.812lm	4.845lm	40°	4.000K	Ø210x150mm

On request



Dali



Emergency kit



Solutions

S



CTE Pack

description

Regulation for the contribution of natural light to comply with the requirements of the CTE. Independent control of two lines of dimmable DALI luminaires with sensor to install in a luminaire or surface box. Preconfigured for easy operation.



CLASSROOMS Pack

description

Regulation by contribution of natural light and stand alone presence. Lighting control system to meet CTE requirements and optimize energy use by taking advantage of natural light and automatic shutdown in case of absence.



Bluetooth package

description

Casambi version of our fixtures that enables through any Bluetooth® terminal via free APP that offers the control of flow regulation, color, scene configuration, behavior linked to schedules. Multiple accessories can be configured to work on the same network to unify the control of one or more spaces, being able to create groups, scenes and dynamic sequences to measure. The Bluetooth® device is valid for any DALI luminaire.

Info

For more information on the different solutions compatible with this luminaire, consult the following BIDI codes or on the web www.prilux.es



Info



You need DALI drive



Info



Transparent glass with matte central section for an adequate glare control