













Specifications (Series luminaires)

| | | |
|---|-----------------------------------|-------------------|
|  | Voltage (V) | 230V |
| Hz | Frecuency (Hz) | 50-60Hz |
| Φ | Power factor (Cos fi) | Hasta >0,57 |
|  | Dimming | No |
|  | Bushing type | E27 |
|  | IP Tightness index | IP20 |
| K | Colour temperature | 3.000K-5.000K |
|  | CRI Colour rendering index | >80 |
|  | Opening angle | 35° |
|  | Measures | 63x82mm |
|  | Operating temperature | -5°C~+35 °C |
| Φ_{LUM} | Flux (lm) | 602lm |
|  | Lifetime | (L70B50>) 25.000h |
|  | CEE Energy classification | E |

References

|  | W | ϕ | ϕ_{LUM} | K | \leftrightarrow |
|---|----|--------|--------------|--------|-------------------|
| 240970 | 8W | >0,57 | 698lm | 5.000K | 63x84mm |
| 543224 | 7W | >0,55 | 55mA | 602lm | 3.000K |

Dimensions

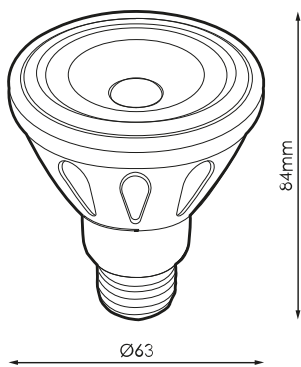

Photometry

Info

Until end of stock