













Spécifications (Luminaires de la série)



	Isolation électrique	CCI
	Tension D` Alimentation (V)	230V
Hz	Fréquence (Hz)	50-60Hz
ϕ	Facteur de puissance (Cos fi)	Hasta $\geq 0,5$
	Atténuation	Non

	Type de bague	E27
	Indice d'étanchéité IP	IP20
	Couleur du corps	Blanc
	Matériau du diffuseur	PC-T
	Corps	PC

K	Température de couleur	3000K-5000K
	CRI Indice de rendu des couleurs	80cromatica
	Angle d'ouverture	35°

	Dimensions	96x95mm
---	-------------------	---------

ϕ_{LUM}	Flux (lm)	938lm
--------------	------------------	-------

	Heures de vie	(L70B50>)25.000h
	Heures de vie	(L70B50>)25.000h
	N° d'allumages	15.000

	CEE Classificatio no énergétique	A+
---	---	----

Les références

	W	ϕ		ϕ_{LUM}	K	
543248	10W	$\geq 0,5$	80mA	919lm	3000K	96x95mm
543255	10W	$\geq 0,5$	80mA	938lm	5000K	96x95mm

Dimensions

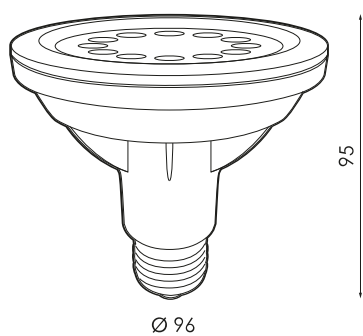

Photométrie