

Applications

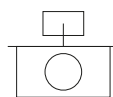

Bureaux

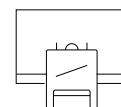

Salles de classe



Salles blanches



Vente au détail



Accueil



Grandes surfaces



Hôtels



Restaurants







Soins de santé

Spécifications (Luminaire de la série)



	Tension D` Alimentation (V)	220-240V
Hz	Fréquence (Hz)	50-60Hz
	Intensité (A)	max.1030mA
ϕ	Facteur de puissance (Cos fi)	Hasta 0,9
	Atténuation	Non
	Indice d'étanchéité IP	IP54
	Couleur du corps	Blanc
	Matériau du diffuseur	VT
	Corps	AL
	Réflecteur	AL AN
K	Température de couleur	3.000K/4.000K
	CRI Indice de rendu des couleurs	>80

	Dimensions	Ø220x85mm
	Position de montage	Empotrar
ϕ_{LUM}	Flux (lm)	2.442lm
	Isolation électrique	CI
	Heures de vie	L70>30.000h

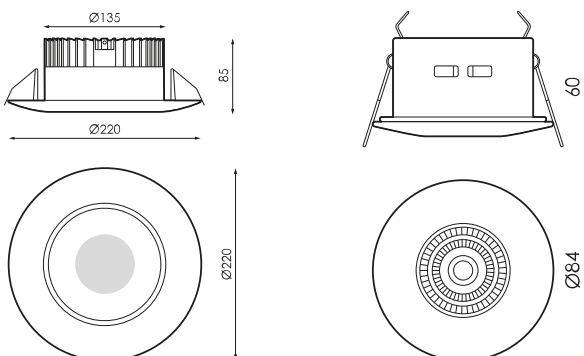

Prilux garantit une tolérance de $\pm 10\%$ dans les mesures de flux lumineux.

Dimensions



Les références



	W _{LED}	W		ϕ_{LED}	ϕ_{LUM}	Δ	K	
233279	35W	42W	1030mA	3.638lm	2.913lm	60°	3.000K	Ø220x85mm
233286	35W	42W	1030mA	3.871lm	3.099lm	60°	4.000K	Ø220x85mm
233293	25W	29W	670mA	2.866lm	2.295lm	60°	3.000K	Ø220x85mm
233309	25W	29W	670mA	3.049lm	2.442lm	60°	4.000K	Ø220x85mm
234054	8W	9W	670mA	834lm	667lm	45°	3.000K	Ø84x60mm
234061	8W	9W	670mA	879lm	703lm	45°	4.000K	Ø84x60mm
234078	8W	9W	670mA	834lm	667lm	45°	3.000K	Ø84x60mm
234085	8W	9W	670mA	879lm	703lm	45°	4.000K	Ø84x60mm

Photométrie

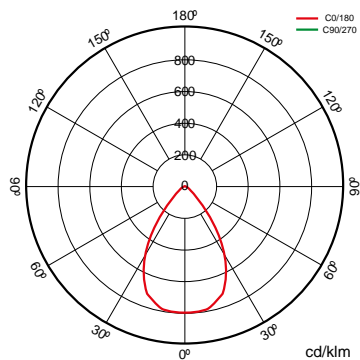

Sur demande



Dali



Trousse d'urgence



Solutions

S



Pack CTE

la description

Règlement pour l'apport de lumière naturelle pour se conformer aux exigences du CTE. Commande indépendante de deux lignes de luminaires DALI gradables avec capteur à installer dans un luminaire ou un boîtier de surface. Préconfiguré pour une utilisation facile.



Pack SALLES

la description

Régulation par apport de lumière naturelle et présence autonome. Système de contrôle de l'éclairage pour répondre aux exigences du CTE et optimiser la consommation d'énergie en profitant de l'apport de lumière naturelle et d'un arrêt automatique en cas d'absence.



Pack Bluetooth

la description

Version de nos luminaires avec communication Bluetooth Casambi qui via n'importe quel terminal Bluetooth® via APP gratuite qui offre le contrôle de la régulation de flux, la couleur, la configuration de la scène, le comportement lié aux horaires. Plusieurs accessoires peuvent être configurés pour travailler sur le même réseau pour unifier le contrôle d'un ou plusieurs espaces, être capable de créer des groupes, des scènes et des séquences dynamiques à mesurer. L'appareil Bluetooth® est valable pour tout luminaire DALI.

Info

Pour plus d'informations sur les différentes solutions compatibles avec ce luminaire, consultez les codes BIDI suivants ou sur le web www.prilux.es



Info



UGR <19 avec R(%):70/70/30, S(m2)<36 y h(m)≥2,8.