

ULTRACAR

CARGO BEDS-RACKS



**AU SERVICE
DES CONCESSIONNAIRES
TEXTO INFO: 514-592-0005**

depuis 1982
2023
514.592.0005



Suivez-nous *Instagram*
ultracar.1982

ROUES POWDERCOAT NOIR LUSTRÉ GLOSS BLACK POWDERCOAT WHEELS



\$149
CHAQUE

DAN
(514) 592-0005



Ultracar Performance Inc. 1254 boul. Marcel-Laurin, Saint Laurent, Montréal, QC H4R 1J7
www.ultracar.com



ROLL YOUR WORLD INSIDE OUT™

Cargo Beds - Access Without Compromise

If you have ever crawled into the back of a pickup truck or other service vehicle's to locate and retrieve heavy items such as tools, equipment and supplies, you will appreciate the functionality and practicality of our versatile roll-out Cargo Bed.

ROLL YOUR WORLD INSIDE OUT™



FEATURES:

- Access to 80% of your cargo space from a standing position outside the vehicle
- A reduction in back injuries and compensation claims
- Built for every make and model of truck including Ford, GM, Dodge & Toyota
- An affordable permanent asset
- Ruggedly built for a lifetime of service
- You are only limited by the carrying capacity of your vehicle
- Takes over where our competition stops!



HEAVY-DUTY PRODUCT DETAILS

- Optimum performance with 3000 lbs capacity.
- Patented bi-directional locking mechanism every 10" for safe and secure rolling
- Available in widths of 21" or 36"
- Available in lengths of 60" to 90"
- Rises only 3" above the truck bed
- All steel maintenance-free construction
- Heavy Duty bearings
- Durable black powder coat finish
- Easy installation



LENGTH	WIDTH	FITS	SERIES	PART NO.
60"	36"	Suburban and Window Vans	Contractor Series	RCB-HD-3660
70"	36"	Fullsize 6.5' Trucks and Vans	Contractor Series	RCB-HD-3670
75"	36"	Fullsize 6.5' Trucks and Vans	Contractor Series	RCB-HD-3675
90"	36"	Fullsize 8' Trucks and Vans	Contractor Series	RCB-HD-3690
60"	21"	Universal	Welder Series	RCB-HD-2160
70"	21"	Universal	Welder Series	RCB-HD-2170
75"	21"	Universal	Welder Series	RCB-HD-2175



WORK SMARTER PLAY HARDER

That is our mantra. The reason we created DECKED. We know that every minute you save during the day, every trip in and out of your vehicle you avoid, every awkward lift you don't have to perform, means you'll gain an edge and have more time and more energy for what really matters. You're damn right we are zealots for good ergonomics and efficient organization. Driven by a passion for perfection and doing the right thing, we are proud to make our products from recycled materials in the good of US of A. We're even prouder to help improve the lives of those who rise early to get to the job done.

We spent three years developing and engineering DECKED and the past four years refining our design with the help of real people in the field using DECKED daily. Thousands of happy customers (and four grouchy ones) later, we are here to say it's an honor to serve our hard working and harder playing customers with an innovative family of products designed to help you Work Smarter so you can Play Harder.

STRENGTH-TO-WEIGHT

2000 lb payload
200 lb per drawer capacity
DECKED overall weight:
230 lb

2000 LB PAYLOAD

A steel sub frame gives the same payload as a standard half-ton truck.

CUSTOM FIT

CAD engineered to match the sidewall of your truck or van for a perfect fit.

EASY TO INSTALL

Attaches to bed tie downs and cargo attachment points for easy install.

HIGH DENSITY POLYETHYLENE (HDPE)

Impervious to the elements and extreme conditions.



STEEL IS REAL

50% of the systems weight is steel. Tubes are in-molded laterally into deck.

AMMO CAN STORAGE

Four ammo cans are located at each corner on a Full Size System offering extra storage.

RECYCLED MATERIALS

Manufactured from 100% recycled HDPE and American steel.

BEEFY WHEELS

Four sealed bearing wheels allow drawers to roll smoothly.

TECHNICAL DATA:



FULL-SIZE SYSTEM

SYSTEM DIMENSIONS

	SHORT	STANDARD
LENGTH	64.54"	75.25"
WIDTH	63"-71"	63"-71"
HEIGHT	12"	12"
DRAWER WIDTH	18"	18"
DRAWER HEIGHT	8.5"	8.5"

MID-SIZE SYSTEM

SYSTEM DIMENSIONS

	SHORT	LONG
LENGTH	56.28"	68"
WIDTH	56"-64"	56"-64"
HEIGHT	12"	12"
DRAWER WIDTH	11"/18"	11"/18"
DRAWER HEIGHT	8.5"	8.5"



SECURE

With your tools, guns, rods and other gear organized in your DECKED system, they are as secure, if not more secure, than under a locked tonneau or canopy. Tailgate locks combined with our design, will keep the bad guys out.



CUSTOMIZABLE

With more options than your facial hair, we've developed a collection of helpful accessories to help you get more out of your system through customizable configuration. Like the first day of November, the options are limitless.



RUGGED & DURABLE

Built from zombie apocalypse-proof HDPE and anti-corrosion treated steel, DECKED is impervious to the elements. Designed to be left out in all conditions, from under a blistering Texas sun to an Alaskan whiteout, DECKED is meant to be ridden hard and put away wet.



WEATHER PROOF

DECKED drawers are designed to be fully water proof and ready for whatever mother nature might bring. While airborne particulate matter like mist or dust might penetrate the drawers, you're gonna have to really screw up and back your truck into a lake to swamp your stuff.

WORK SMARTER

Our company mission is to make life easier for the working man and woman. Whatever your mission, DECKED helps you work smarter with increased efficiency and less wear and tear on your body.



PLAY HARDER

Fishing, hunting, camping, boating - You name it, DECKED maximizes the flexibility of your vehicle's bed. We engineered DECKED to keep your gear dry, secure and organized.

DECKED APPLICATION GUIDE

WHAT WE FIT

DECKED fits most trucks and cargo vans made from the late 90's to today. Refer to DECKED.COM for our most current fitment guide.

YEAR	MODEL	BED LENGTH	PART NO.	YEAR	MODEL	BED LENGTH	PART NO.
CHEVROLET/GMC				FORD			
20-23	Silverado/Sierra 2500/3500HD	6'9"	DEC-DG8	17-22	Super Duty	6'9"	DEC-DS3
20-23	Silverado/Sierra 2500/3500HD	8'	DEC-DG10 ¹	17-22	Super Duty	8'	DEC-DS4 ¹
07-19	Silverado/Sierra 2500/3500HD	6'6"	DEC-DG4	09-16	Super Duty	6'9"	DEC-DS2
07-19	Silverado/Sierra 2500/3500HD	8'	DEC-DG5 ¹	99-08	Super Duty	6'9"	DEC-DS1
19-23	Silverado/Sierra 1500 - New "wide" bed	5'8"	DEC-DG6	99-16	Super Duty	8'	DEC-DS5 ¹
19-23	Silverado/Sierra 1500 - New "wide" bed	6'6"	DEC-DG7	21-23	F150 / Raptor w/Pro onboard panel	5'6"	DEC-DF8
19-23	Silverado/Sierra 1500 - New "wide" bed	8'	DEC-DG9	21-23	F150 / Raptor w/Pro onboard panel	6'6"	DEC-DF9
07-18	Silverado/Sierra 1500	5'8"	DEC-DG3	15-23	F150	5'6"	DEC-DF4
07-18	Silverado/Sierra 1500	6'6"	DEC-DG4	15-23	F150	6'6"	DEC-DF5
07-18	Silverado/Sierra 1500	8'	DEC-DG5 ¹	15-23	F150	8'	DEC-DF7 ¹
15-22	Colorado/Canyon	6'	DEC-MG4	04-14	F150	5'6"	DEC-DF2
DODGE/RAM/JEEP				NISSAN			
10-23	Ram 2500/3500	6'4"	DEC-DR4	04-14	F150	6'6"	DEC-DF3
03-09	Ram 2500/3500	6'4"	DEC-DR2	19-23	Ranger	5'	DEC-MF3
03-23	Ram 2500/3500	8'	DEC-DR5 ¹	19-23	Ranger	6'	DEC-MF4
19-23	Ram 1500 (New Body)	6'4"	DEC-DR7	TOYOTA			
19-23	Ram 1500	5'7"	DEC-DR6	22-23	Tundra	5'6"	DEC-DT3
09-22	Ram 1500 w/ Ram Box	6'4"	DEC-DR9	22-23	Tundra	6'5"	DEC-DT4
09-22	Ram 1500 w/ Ram Box	5'7"	DEC-DR8	07-21	Tundra	5'6"	DEC-DT1
09-18	Ram 1500 & 19-23 1500 Classic	5'7"	DEC-DR3	07-21	Tundra	6'6"	DEC-DT2
09-18	Ram 1500 & 19-23 1500 Classic	6'4"	DEC-DR4	05-18	Tacoma	6'	DEC-MT6
02-18	Ram 1500 & 19-23 1500 Classic	8'	DEC-DR5 ¹				
20-23	Gladiator	5'	DEC-MJ1				

FOOTNOTE: 1. This system is engineered to be installed in trucks with 8' beds. They are NOT 8' long DECKED systems. The DECKED system orients towards the tailgate. As a result, there is a gap from the cab side edge of the DECKED system that allows room for a narrow crossover toolbox or fuel transfer tank.

ACCESSORIES



DRAWER ORGANIZER

The Draworganizer nests into the handle end of your drawers creating a handy, useful storage space for small tools, hardware, bugspray, duct tape.

PRODUCT DIMENSIONS:
W: 17.625"
L: 10.125"
H: 8"
2.6 lbs

Fits all full-size drawers and midsize wide drawer. Does not fit midsize system narrow drawer.

DEC-AD7-DRAWER ORGANIZER

Double Draworganizer

PRODUCT DIMENSIONS:
W: 17.625"
L: 16.125"
H: 8"
6 lbs

Fits all full-size drawers and midsize wide drawer. Does not fit midsize system narrow drawer.

DEC-AD17-DDRAWER ORGANIZER

IMAGE #	DESCRIPTION	PART NO.	IMAGE #	DESCRIPTION	PART NO.
1	Drawer Lock Set	DEC-AD30LOCKSET	5	NARROW Piecekeepers Firearms Holder (pair)	DEC-AD16MSPK
2	Wide Drawer Dividers	DEC-AD8WIDEX4	6	Core Trax 1000 - 48" (pair)	
	Wide Drawer Dividers	DEC-AD8WIDEX2		w/4 Attachment Loops	DEC-AT1*
	Narrow Drawer Dividers	DEC-AD8NARROWX2		Core Trax 1000 - 58" (Pair)	
	Divider Combo Package	DEC-AD8COMBO		w/4 Attachment Loops	DEC-AT2*
3	Drawer Drain Plug Set	DEC-AD4			
4	D-Box - Drawer Tool box - Blue Lid	DEC-AD5			
	Crossbox - Drawer Tool box - Blue Lid	DEC-AD6			
	D-Box - Drawer Tool box - Desert Tan Lid	DEC-AD5-DTAN			
	Crossbox - Drawer Tool box - Desert Tan Lid	DEC-AD6-DTAN			

* Core Trax Accessories are only compatible with FULL SIZE system

DECKED

TOOL BOX

The DECKED Truck Tool Box is the only toolbox on the market that's easy to access, won't ding, dent or rust, and looks like it came from this decade. Secure. Waterproof. Nearly Indestructible. 100% Made in USA. Forget crawling into your truck to reach tools and gear! We've developed an optional ladder that easily drops to the ground, takes up minimal space, and telescopes closed inside the DECKED Truck Tool Box. With industrial strength durability and security, the DECKED Truck Tool Box is constructed using injection molded high-impact resin with galvanized steel and aluminum reinforcement. This thing is a Fort Knox disguised as a truck tool box.



TECH SPECS

MATERIALS:
LID: Steel Reinforced Injection Molded High-Impact Polymer Resin
BASE: Injection Molded, Impact Treated High Density Polyethylene
HARDWARE: Anti-Corrosion Treated Steel and Aluminum

WEIGHT:
WITH LADDER: 114 lbs.
WITHOUT LADDER: 103 lbs.

STORAGE & PAYLOAD:
STORAGE CAPACITY:
9.82 FT³
73.4 Gallons
PAYLOAD:
500LB Dynamic Payload

EXTERNAL DIMS:
LENGTH: 76"
WIDTH: 22"
HEIGHT TOTAL: 20.53"
HEIGHT ABOVE BEDRAIL: 5.78"

INTERNAL DIMS:
WIDTH AT THE SEAL: 17.9"
WIDTH OF LADDER VERTS: 13.5"
INTERNAL LENGTH: 60"
DEPTH: 17.4"

TRUCK COMPATIBILITY

Fits the following Truck Years 01-23
Chevy Silverado 1500/2500/3500
GMC Sierra 1500/2500/3500
Ford F150/Super Duty
Dodge Ram 1500/2500/3500
Toyota Tundra
Nissan Titan

8' trucks with the DECKED Drawer System

The following part numbers ARE compatible DF6 / DF7 / DS4 / DS5 / DG9 / DG10 / DR5



WITH LADDER
DEC-TBFDL

NO LADDER
DEC-TBFD

- OPTIONAL LADDER**
Low-profile, easily telescopes closed. Accommodates a max bed rail height of 60"
- TORSION SPRINGS**
Effortless lid opening and closing. No slamming of fingers
- TIE DOWNS**
(2) tie-downs at base of tub for securing a moto/ATV or large cargo
- WATERPROOF**
Seamless, watertight construction. EPDM lid gasket
- LOCK AND KEY**
Steel armored locking mechanism combined with driver side lock. Comes with (2) keys
- D-BOX INCLUDED**
Blue D-Box included with Tool Box. Hangers inside tub to hold in place
- SNACK TRAY INCLUDED**
Tray for small tools & gear. Included with Tool Box

OPTIONAL LADDER



DEC-TBFDLADDER

SNACK TRAY



DEC-ATB1SST



HERITAGE

THE ULTIMATE CARGO RETRIEVAL SYSTEM

1200 LB CAPACITY
EVENLY DISTRIBUTED



STANDARD FEATURES

- 3/4" Plywood Deck With Automotive Grade Carpet
- 4" Aluminum Side Rails
- 4 Sealed Roller Bearings
- Spring Release T-Handle (Hidden Under Deck To Maximize Cargo Area)
- Solid Linkage Locking Mechanism
- 3 Locking Positions
- Powder Coated Steel Frames
- Fully Assembled
- With Patented "L" Hooks Installs In Less Than 30 Minutes
- Custom Sizes And Applications Are Available
- 5 Year Limited Warranty

YEAR	MODEL	BED	PART NO.	YEAR	MODEL	BED	PART NO.
CHEVROLET/GMC				FORD (cont)			
19-23	Silverado/Sierra 1500 & 20-23 HD	6'6"	CRG-CE7848	73-23	F150	6'6"	CRG-CE7548
19-23	Silverado/Sierra 1500	5'8"	CRG-CE6548	01-23	F150 w/o Boxliner	5'6"	CRG-CE6548
73-18	Silverado/Sierra 1500 & 73-19 HD	8"	CRG-CE9548	01-23	F150 w/ Boxliner	5'6"	CRG-CE6347
73-18	Silverado/Sierra 1500 & 73-19 HD	6'6"	CRG-CE7548	73-98	F-Series	8"	CRG-CE9548
04-18	Silverado/Sierra	5'8"	CRG-CE6548	73-98	F-Series	6'6"	CRG-CE7548
DODGE/RAM				NISSAN			
72-23	Ram 1500/2500/3500	8"	CRG-CE9548	04-21	Titan	8"	CRG-CE9548
03-23	Ram 2500/3500	6'4"	CRG-CE7348	04-21	Titan	6'6"	CRG-CE7548
72-02	Ram 2500/3500	6'6"	CRG-CE7548	04-21	Titan	5'7"	CRG-CE6548
02-23	Ram 1500	6'4"	CRG-CE7348	TOYOTA			
72-01	Ram 1500	6'6"	CRG-CE7548	22-23	Tundra	8"	CRG-CE9547
09-23	Ram 1500 w/o Boxliner	5'7"	CRG-CE6548	22-23	Tundra	6'5"	CRG-CE7547
09-23	Ram 1500 w/ Boxliner	5'7"	CRG-CE6347	22-23	Tundra	5'5"	CRG-CE6347
FORD				07-21	Tundra	6'6"	CRG-CE7548
99-22	F250 F350	8"	CRG-CE9548				
99-22	F250 F350	6'9"	CRG-CE8048				

COMMERCIAL SLIDES



2000 LB CAPACITY
EVENLY DISTRIBUTED



STANDARD FEATURES

- 3/4" Plywood Deck With 1/4" Rubber Mat
- 8" Aluminum Side Rails
- 8 Heavy Duty Sealed Roller Bearings
- Spring Release T-Handle (Hidden Under Deck To Maximize Cargo Area)
- Solid Linkage Locking Mechanism
- 3 Locking Positions
- Powder Coated Steel Frames
- Fully Assembled
- With Patented "L" Hooks Installs In Less Than 30 Minutes
- Custom Sizes And Applications Are Available
- 5 Year Limited Warranty

YEAR	MODEL	BED	PART NO.	YEAR	MODEL	BED	PART NO.
CHEVROLET/GMC				FORD (cont)			
19-23	Silverado/Sierra 1500 & 20-23 HD	6'6"	CRG-CE7848C20	73-23	F150	6'6"	CRG-CE7548C20
19-23	Silverado/Sierra 1500	5'8"	CRG-CE6548C20	01-23	F150 w/o Boxliner	5'6"	CRG-CE6548C20
73-18	Silverado/Sierra 1500 & 73-19 HD	8"	CRG-CE9548C20	01-23	F150 w/ Boxliner	5'6"	CRG-CE6347C20
73-18	Silverado/Sierra 1500 & 73-19 HD	6'6"	CRG-CE7548C20	73-98	F-Series	8"	CRG-CE9548C20
04-18	Silverado/Sierra	5'8"	CRG-CE6548C20	73-98	F-Series	6'6"	CRG-CE7548C20
DODGE/RAM				NISSAN			
72-23	Ram 1500/2500/3500	8"	CRG-CE9548C20	04-21	Titan	8"	CRG-CE9548C20
03-23	Ram 2500/3500	6'4"	CRG-CE7348C20	04-21	Titan	6'6"	CRG-CE7548C20
72-02	Ram 2500/3500	6'6"	CRG-CE7548C20	04-21	Titan	5'7"	CRG-CE6548C20
02-23	Ram 1500	6'4"	CRG-CE7348C20	TOYOTA			
72-01	Ram 1500	6'6"	CRG-CE7548C20	22-23	Tundra	8"	CRG-CE9547C20
09-23	Ram 1500 w/o Boxliner	5'7"	CRG-CE6548C20	22-23	Tundra	6'5"	CRG-CE7547C20
09-23	Ram 1500 w/ Boxliner	5'7"	CRG-CE6347C20	22-23	Tundra	5'5"	CRG-CE6347C20
FORD				07-21	Tundra	6'6"	CRG-CE7548C20
99-22	F250 F350	8"	CRG-CE9548C20	07-21	Tundra	5'6"	CRG-CE6348C20
99-22	F250 F350	6'9"	CRG-CE8048C20				

CARGO LOCKERS



UNIQUE HIGH CAPACITY

2000 LB CAPACITY
EVENLY DISTRIBUTED

Standard Sizes:

- 95" x 48"
- 80" x 48"
- 75" x 48"
- 73" x 48"
- 65" x 48"
- 63" x 48"

Special Order Only

STANDARD FEATURES

- 600 Lbs Capacity Per Drawer System
- 8 Ft. Lengths Available
- Structural Aluminum Frame With Composite Top Decking
- Dual Drawer Systems
- Standard 9" and Max 12" Heights
- Automotive Grade Carpet-Lined Drawers
- 1 Long and 1 Wide Drawer Divider
- 12-Bearing Single Drawer, 24-Bearing Dual Drawer
- Turn Key Dual Latching Locking System
- Cargo Ease Slide Mounting Bracket

Holman Formerly **Kargo Master** **TRUCK RACKS**

PRO II HEAVY-DUTY STEEL TRUCK RACKS



The Holman Pro II Truck Ladder Rack is one of the toughest heavy-duty racks in the market. The Holman Pro II Truck Rack is built with 2" diameter round steel tubing that has a 1,700 lb. loading capacity (evenly distributed). The sleek round tube design significantly reduces wind drag and noise and creates a uniform load distribution that results in a sturdier rack. All Holman truck racks are treated with zinc primer and marine grade powder coat to achieve excellent corrosion and UV resistance.

Pro II Steel Truck Racks are available for all full size trucks in a standard and extended/crew cab style that fits 6.5ft and 8ft bed lengths. Also available for trucks with cab high camper shells.

Specifications:

- Yellow Zinc plated hardware
- Cosmetic button head bolts
- Nyloc self locking nut
- 1700 LB cargo capacity (evenly distributed)
- 2" dia x .083 thick high tensile strength steel
- Zinc Epoxy undercoat
- High gloss black marine grade powder coat finish
- Swagged tube joints
- 1000 hours ASTM salt spray resistance

AVAILABLE FOR TRUCKS WITH CAMPER SHELLS



For complete kit order: (1) Side Channels (1) Leg Bars

WINDOW GUARD



Protects rear cab window while adding support to both the rack and truck bed. Features pre-punched mounting slots and fully rolled finished edges. Powder coated 16 gauge cold rolled steel.

- HLM-31080 - Black
- HLM-31080C - Clamp Kit *
- (* Required for use with HLM-01040 Super Duty Leg Kit or HLM-80000 PRO III Rack)

YEAR	MAKE	SIDE CHANNELS PART NO.	LEG BARS W/O SHELL PART NO.	LEG BARS W/ SHELL CAB HIGH ONLY! PART NO.
REGULAR CAB LONG BOX 8'				
1980-23	Silverado/Sierra	HLM-04000	HLM-01000	HLM-01110
1980-23	Ram	HLM-04000	HLM-01000	HLM-01110
1999-22	Super Duty	HLM-04000	HLM-01040	HLM-01130
1985-97	F150/250/350	HLM-04000	HLM-01000	HLM-01110
1997-23	F150	HLM-04000	HLM-01000	HLM-01110
2000-21	Tundra	HLM-04000	HLM-01000	HLM-01110
EXTENDED/CREW CAB LONG BOX 8'				
1980-23	Silverado/Sierra	HLM-06000	HLM-01000	HLM-01110
1980-23	Ram	HLM-06000	HLM-01000	HLM-01110
1999-22	Super Duty	HLM-06000	HLM-01040	HLM-01130
1985-97	F150/250/350	HLM-06000	HLM-01000	HLM-01110
1997-23	F150	HLM-06000	HLM-01000	HLM-01110
2000-21	Tundra	HLM-06000	HLM-01000	HLM-01110
EXTENDED/CREW CAB SHORT BOX 6.5'				
1980-23	Silverado/Sierra	HLM-06010	HLM-01000	HLM-01110
1980-23	Ram	HLM-06010	HLM-01000	HLM-01110
1999-22	Super Duty	HLM-06010	HLM-01040	HLM-01130
1985-97	F150/250/350	HLM-06010	HLM-01000	HLM-01110
1997-23	F150	HLM-06010	HLM-01000	HLM-01110
2000-21	Tundra	HLM-06010	HLM-01000	HLM-01110

Footnote: 1 - Use Leg Extensions HLM-31530 for all F15 Trucks with High Rise Caps (99-16 Super Duty - use HLM-31540) ALL SKIRTED CAPS MUST BE MODIFIED.

Holman Formerly Kargo Master TRUCK/VAN RACKS

PRO III MEDIUM-DUTY TRUCK RACKS/LADDER RACKS



Fullsize Trucks
HLM-80000

Mini / Midsize Trucks
HLM-80020



Fits without camper shells. These truck racks - ladder racks can be adjusted without cutting to fit all makes and models of vehicle. 1000 lb load capacity (evenly distributed).

PRO III MEDIUM-DUTY CARGO RACK - FULLSIZE VAN

This versatile rack has you covered no matter your cargo, sheet goods, ladders, carpet, or pipe. This rack can carry it all



- 5 Crossbars (includes wind deflector) for loading a variety of materials and ladders
- 1,000 lb. capacity
- Rear roller bar for easier loading and unloading of long materials
- Fits Transit Low/Mid Roof, Sprinter or ProMaster Standard Roof, NV Low Roof and GM fullsize vans
- Black gloss finish
- Lifetime Warranty

YEAR	MODEL	CARGO	MOUNT KIT
98-23	Chev Express/GMC Savana	HLM-40890	HLM-4089C
ALL	Ram ProMaster (standard roof)	HLM-40890	HLM-4089P
ALL	Ford Transit (low/mid roof)	HLM-40890	HLM-4089T
ALL	Mercedes Sprinter	HLM-40890	HLM-4089T
ALL	Nissan NV	HLM-40890	HLM-4089T



Dimensions:
158.3" L x 63" W x 9.5" H from roller bar (6.3" side rail height)

UTILITY ECONO VAN RACK

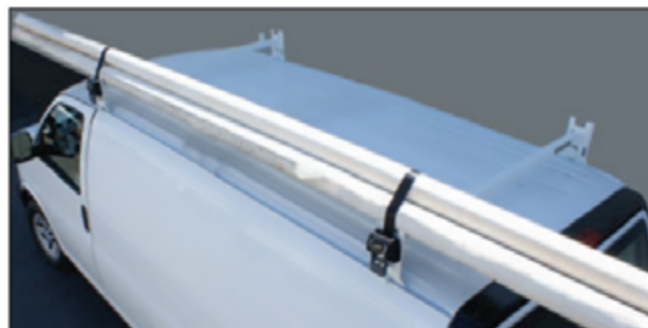

- Includes two heavy-duty 1-3/4" square steel cross bars.
- No drilling or cutting required.
- Wide mount coated feet clamp securely to rain gutter and protect paint.
- Zinc epoxy primed for superior rust resistance.
- Ratchet strap tie downs sold separately.

MODEL	RACK
Chev Express/GMC Savana	HLM-40823
Ram ProMaster City	HLM-40821
Ford Transit Connect	HLM-40821
Mercedes Metris	HLM-40821
Nissan NV (Low Roof or 200)	HLM-40821

Holman Formerly Kargo Master VAN RACKS

EZ - LODOWN™ DROP DOWN LADDER RACK



- Heavy-duty mechanism in lowered position brings a horizontal ladder to only 4" above grade. About 15" lower than leading competition models. Holds both extension and step ladders.
- Adjustable clamps firmly secure ladder to rack.
- Rung grips are adjustable to secure all sizes of extension ladders.
- No drilling or cutting required.
- Rugged cross bars hang low over van roof to reduce overall vehicle height.
- Wide mount coated feet clamp securely to rain gutter and protect paint.
- Zinc epoxy primed for superior rust resistance. Chip resistant white powder coat.
- Assist, dampener arms and driver side load retainers included.

Single and Mount required for Basic kit. Double & Combo options are added to Basic kit.

YEAR	MODEL	Required		Optional Upgrades
		SINGLE	MOUNT	DOUBLE
DROP DOWN LADDER RACK		(CURB SIDE)		(DRIVER SIDE DROP DOWN)
98-23	Chev Express/GMC Savana	HLM-4092L	HLM-409CD	HLM-40963
All	Ram Low Roof Promaster	HLM-4097M	HLM-4081P	HLM-40983
All	Ram High Roof Promaster	HLM-4099H	HLM-4081P	
All	Ford Low Roof Transit	HLM-4092L	HLM-409TD	HLM-40963
All	Nissan Low Roof NV	HLM-4092L	HLM-409ND	HLM-40963

CLAMP & LOCK LADDER RACK FOR COMMERCIAL VANS

Whatever it may be, this ladder rack will transport it securely to wherever your job takes you.

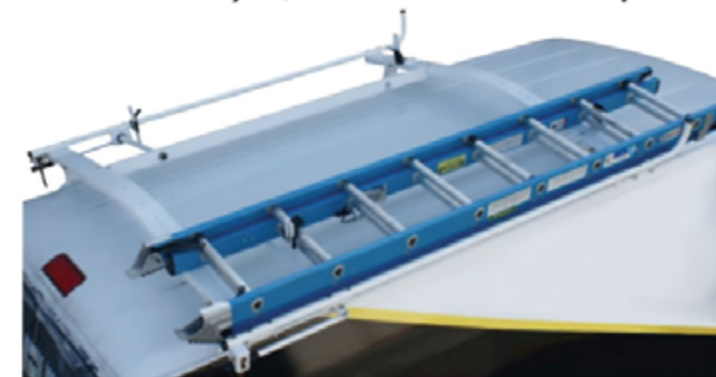

- Rugged cross bars hang low over van roof to reduce overall vehicle height and help with loading and unloading.
- Easy to reach lockable clamp arm and adjustable ladder grips firmly secures ladders (step and extension) to rack.
- No drilling or cutting required.
- Wide mount coated feet clamp securely to rain gutter and protect paint.
- Zinc epoxy primed for superior rust resistance. Chip resistant white powder coat.
- Curb side clamp mechanism and driver side load retainers included.

YEAR	MODEL	Required		Optional Upgrades
		SINGLE CLAMP & LOCK	MOUNT	DRIVER SIDE MECHANISM
LADDER RACK		(CURB SIDE)		
98-23	Chev Express/GMC Savana	HLM-4082L	HLM-408CC	HLM-4081L
All	Ram ProMaster City	HLM-4080L	Included	HLM-4081L
All	Ford Low Roof Transit	HLM-4082L	HLM-408TC	HLM-4081L
All	Nissan Low Roof NV	HLM-4082L	HLM-408NC	HLM-4081L

weather guard
ALUMINUM SAFARI VAN RACK

500 LBS Load Capacity

Load Assist Roller Bar
Protects the vehicle while simplifying loading & unloading of ladders and materials

Adjustable Ladder Stops & Tie Down Points
Enables user to setup rack in most efficient and effective way for their use

Aluminum Construction
Lightweight and corrosion resistant

3 SIZES AVAILABLE

FULL SIZE EXTENDED

WEA-ASRL001

- Product Size 149" x 72.5" x 10.25"
- Fits full-size vans
- Mounting channel & gutter mount

FULL SIZE

WEA-ASRS001

- Product Size 125" x 72.5" x 10.25"
- Fits full-size vans
- Mounting channel & gutter mount

COMPACT SIZE

WEA-ASRC001

- Product Size: 95" x 62.5" x 10.25"
- Fits compact vans
- Mounting channel only

Mounting Channels are sold separately and are required for installation

MAKE	WHEEL BASE	MOUNT KIT	COMPACT	FULL SIZE	FULL SIZE EXTENDED
Ford Transit	130	WEA-2130-0-01		WEA-ASRS001	
	148	WEA-2102-0-01		WEA-ASRS001	
	148X	WEA-2102-0-01			WEA-ASRL001
Ram ProMaster	118/136	WEA-2115-0-01		WEA-ASRS001	
	159/159X	WEA-2115-0-01			WEA-ASRL001
Mercedes Sprinter	144/170/170X	WEA-2113-0-01			WEA-ASRL001
GM Savana/ Chevrolet Express	135 155	Not Required Not Required		WEA-ASRS001	WEA-ASRL001
Compact (Transit Connect, ProMaster City, Metris)	PM City, FTC, Metris	WEA-2085-0-01	WEA-ASRC001		

weather guard
DROP DOWN LADDER RACK

EZGlide2™

- ▶ **EASIEST TO OPERATE**
 - 50% easier to operate than competitor drop-down ladder racks to reduce strain.
 - Drop-down feature improves user safety when handling heavy ladder loads.
 - Heavy duty design holds the toughest loads and lasts longer.
- ▶ **LIGHTEST WEIGHT DROP-DOWN LADDER RACK AVAILABLE**
 - Maximize roof weight capacity to hold the important items.
 - Great fuel economy whether empty or fully loaded.
- ▶ **MOST VERSATILE**
 - Fits extension ladders up to 40' and step/podium ladders from 3' - 12' with extra drop-down mechanism.
 - Easily operates with up to 100 lbs of ladder weight per side.
 - Optional third cross-member accommodates conduit carrier for secure storage.

VAN FIT GUIDE

STEP 1

CHOOSE A MOUNTING KIT

(Mounting kits are not needed for Chevy Express, GMC Savanna or Ford E-Series vans, go to Step 2.)

PART NO.	DETAILS
WEA-2115-0-01	Ram ProMaster Mounting Channel Kit - 115" Wheel Base (low/Mid/High Roof)
WEA-2102-0-01	Ford Transit Mounting Channel Kit - 148" Wheel Base (low/Mid/High Roof)
WEA-2130-0-01	Ford Transit Mounting Channel Kit - 130" Wheel Base (low/Mid Roof)
WEA-2113-0-01	Mounting Channel Kit for Sprinter, Nissan NV
WEA-2085-0-01	Compact Mounting Channel Kit for Ford Transit Connect, Chevy City Express, RAM ProMaster City, Nissan NV200, Nissan NV High Roof)

STEP 2

SELECT A DROP-DOWN LADDER RACK ASSEMBLY

(Single-Side Only with Cross Members)

Fits 20' - 40' Extension, 10' - 12' Step and 6' - 10' Podium. Drop down can mount on driver or passenger side.

PART NO.	DETAILS
WEA-2291-3-01	Extended Drop-Down for Mid-Roof/High-Roof Vans (Includes Two 70" Cross Members & 89" Center Tube)
WEA-2271-3-01	Fixed Drop-Down for Full-Size Vans (Includes Two 70" Cross Members & 89" Center Tube)

ALUMINUM CONDUIT CARRIER

Keep your conduit safe, secure and clean with our lightweight and durable conduit carrier.

PART NO.	DETAILS	LENGTH	WIDTH	HEIGHT
WEA-237	Conduit Carrier	121.5"	11"	6"
WEA-238	Extension	6"	11"	6"

OPTIONAL

MAKE IT A DUAL DROP-DOWN LADDER RACK

Long ladder kits fit 20' - 40' Extension, 10' - 12' Step and 6' - 10' Podium. Short ladder kits include center cross member to carry shorter ladders on opposite side

PART NO.	DETAILS
WEA-2295-3-01	Extended Drop-Down Long Ladder Kit for Mid-Roof/High-Roof Vans (Includes 89" Center Tube)
WEA-2297-3-01	Extended Drop-Down Short Ladder Kit for Mid-Roof/High-Roof Vans (Includes 70" Cross Member & 36" Center Tube)
WEA-2275-3-01	Fixed Drop-Down Long Ladder Kit for Full Size Vans (Includes 89" Center Tube)
WEA-2277-3-01	Fixed Drop-Down Short Ladder Kit for Full Size Vans (Includes 70" Cross Member & 36" Center Tube)

MAKE-YOUR-OWN CONDUIT CARRIER

PVC not included. Separately purchase a section of standard 6" PVC plastic drain pipe. Coordinate the length of the PVC with the length of conduit you'll be carrying.

PART NO.	DETAILS
WEA-239	Universal



VAN SOLUTIONS

ALL-PURPOSE STEEL VAN RACKS

- DURABILITY**
all steel construction - powder coat paint finish - industry-leading 3-bar load capacity (1,000 lbs)
- PROTECTION**
anti-wear cross member stripping protects ladder and materials against damage
- GLIDESAFE™ LOAD ASSIST**
helps with loading and unloading - protects roof from damage
- ADJUSTABLE GUIDES & STOPS**
no tools needed with easy-grip handles
- MOUNTING OPTIONS**
direct to OEM mounting points - WG roof rails
- AIR FOIL**
reduces wind noise



VAN RACKS

DESCRIPTION	PART NO.
F/S Van - Ford, Nissan, Ram, Sprinter - 2 Bar	WEA-20501-3-01
F/S Van - Ford, Nissan, Ram, Sprinter - 3 Bar	WEA-21501-3-01
F/S Van - Gutter Mount - 2 Bar	WEA-205-3
F/S Van - Gutter Mount - 3 Bar	WEA-216-3

ACCESSORY CROSS MEMBERS

DESCRIPTION	PART NO.
Compact Van - Ford, GM, Nissan, Ram	WEA-22101-3-01
Gutter Mount	WEA-2056-3

ALUMINUM QUICK CLAMP RACK

Our Quick Clamp Racks are engineered to make loading and unloading your ladder an easy, one-person operation.



2 CLAMP STYLES:
Dual Clamp (Street and Curb Side)
Single Clamp (Curb Side Only)

* Use with Model 2085-0-01 Mounting Channel kit for Ford Transit Connect, Nissan NV200, Chev City Express and Ram Promaster City.

PART NO.	FITS	CLAMP STYLE
WEA-234-3-03	GM, Ford E-Series	Dual Clamp
WEA-224-3-03	Ford Transit Connect, Nissan NV200 Chev City Express, Ram ProMaster City	Dual Clamp
WEA-223-3-03	Ford Transit Connect, Nissan NV200 Chev City Express, Ram ProMaster City	Single Clamp

ALL-PURPOSE ALUMINUM RACK

This all purpose rack is designed with a mounting leg that fully adjusts to the contour of the van. Model 218-3-03 contains 2 Powder Coated cross member racks that fit compact vans.



* Use with Model 2085-0-01 Mounting Channel kit for Ford Transit Connect, Nissan NV200, Chev City Express and Ram Promaster City.

PART NO.	FITS
WEA-218-3-03	Ford Transit Connect, Ram ProMaster City, Nissan NV200, Chev City Express, Mercedes Metris

FULL-SIZE ACCESSORY CROSS MEMBER

Works with model WEA-234-3-03 Quick Clamp Racks to accommodate short ladders and provide additional support.



PART NO.	FITS
WEA-233-3-03	WEA-234-3-03

FULL-SIZE VAN ALUMINUM RACK

This all purpose rack is designed to clamp to roof gutters. It features extruded aluminum cross members with a double tube design for maximum carrying capacity. Contains 2 Powder Coated cross members.



PART NO.
WEA-209-3-03 (2 crossmember rack)

FULL-SIZE HEAVY DUTY STEEL RACK

This all purpose rack features cross members made of 14-gauge steel tubing. Mounting base is extra-wide 12-gauge steel for superior attachment strength to the gutter.



PART NO.	FITS
WEA-216-3	Ford 92-13/ GM 96-23



VAN SOLUTIONS

BULKHEADS

Our Full-Size, High-Roof, and Compact van bulkheads allow you to separate the driver compartment from the cargo area for maximum protection against shifting loads. Exclusive polycarbonate windows improve visibility and safety. Tighter panel design ensures cabin comfort, both noise and temperature. WEATHER GUARD™ Bulkheads are available for all commercial van types and sizes, from high-roof to compact. Several bulkhead accessories are available to keep you organized.

EASY INSTALLATION
with sidewall and roof mounting brackets and pre-punched mounting holes for WEATHER GUARD™ accessories

HEAVY GAUGE STEEL
is used for strength and durability

IMPROVED IMPACT RESISTANCE
protects you from loose objects in the cargo area

EXCLUSIVE 9" X 12" DOG HATCH™ DOOR
allows easy loading of long materials by utilizing the floor space in front of the bulkhead



POLYCARBONATE WINDOW BULKHEADS
allow for improved visibility, security and comfort

PROVIDES IMPROVED HEATING AND COOLING EFFICIENCY
in the passenger area

NEW VERTICAL PANEL DESIGN
reduces ambient noise levels

OPTIONAL HINGE KIT
converts bulkhead to swing door version with lockable latch

FULL SIZE VAN BULKHEADS

DESCRIPTION	PART NO.
Full Size Van Universal	WEA-96101-3-01
Nissan NV Van	WEA-96201-3-01
Full Size Ford, GM Van	WEA-96102-3-01

HIGH-ROOF VAN BULKHEADS

DESCRIPTION	PART NO.
Ford Transit Van	WEA-96321-3-01
Ford Transit Van Deep Offset	WEA-96321-3-01D
Nissan NV Van	WEA-96201-3-01

MID-ROOF VAN BULKHEADS

DESCRIPTION	PART NO.
Ford Transit Van w/ Dog Hatch	WEA-96311-3-01 ⁴
Ford Transit Van (screen windows)	WEA-96312-3-01 ⁴

COMPACT SIZE VAN BULKHEADS

DESCRIPTION	PART NO.
Chev City Express	WEA-96514-3-01
Nissan NV200	WEA-96514-3-01
Ram Promaster (window)	WEA-96512-3-01
Compact Size Van Solid Universal	WEA-96511-3-01
Compact Size Van Mesh Universal	WEA-96111-3-01

LOW-ROOF VAN BULKHEADS

DESCRIPTION	PART NO.
Ford Transit Van	WEA-96301-3-01 ⁴

Footnotes:

⁴ WEA-96901-3-01 Hinge kit converts full size bulkhead to swinging door

CABMAX™ COMPOSITE BULKHEADS

TIGHT FIT
improves climate control - reduces noise

INCREASED CAB SPACE
allows for full seat travel with maximized recline - provides additional storage and work space

WINDOW ACCESSORY
allows for visibility



ORGANIZATION
accessory panels allow for customized organization options on the cab and cargo sides

DOG HATCH™ DOOR ACCESSORY
allows for use of additional cab floor storage for long materials

CAB SIDE COMPOSITE BULKHEADS

DESCRIPTION	PART NO.
Ford Transit Mid/High-Roof - Base	WEA-96310-3-01
Ford Transit High Roof - Header Panel	WEA-96320-3-01*

Footnotes: * Requires Base (WEA-96310-3-01)

CARGO SIDE ACCESSORIES

DESCRIPTION	PART NO.
Bulkhead Accessory Panels (2-pack)	WEA-96905-3-01
Window Accessory for F/S Vans	WEA-96906-3-01
Dog Hatch™ Door Accessory for F/S Vans	WEA-96908-3-01



VAN SOLUTIONS

HEAVY DUTY ADJUSTABLE SHELF UNITS

Heavy duty adjustable van shelving units helps maximize van storage customization and capacity.

- Newly designed adjustable shelves are deeper to hold more tools and equipment
- Captive nuts at each corner allow for easier assembly and quieter operation
- Fully hemmed shelves for extra strength and durability
- Accessory mounting holes eliminates the need for mounting brackets and drilling holes
- Brite White ARMOR-TUF® Powder coat finish



2 SHELF UNIT

PART NO.	HEIGHT	WIDTH	DEPTH
WEA-9334-3-03	34"	42"	13.5"
WEA-9335-3-03	34"	52"	13.5"
WEA-9336-3-03	34"	60"	13.5"

3 SHELF UNIT

PART NO.	HEIGHT	WIDTH	DEPTH
WEA-9343-3-03	44"	36"	16"
WEA-9344-3-03	44"	42"	16"
WEA-9353-3-03	44"	36"	13.5"
WEA-9354-3-03	44"	42"	13.5"
WEA-9355-3-03	44"	52"	13.5"
WEA-9356-3-03	44"	60"	13.5"

4 SHELF UNIT

PART NO.	HEIGHT	WIDTH	DEPTH
WEA-9363-3-03	60"	36"	16"
WEA-9364-3-03	60"	42"	16"
WEA-9365-3-03	60"	52"	16"
WEA-9373-3-03	60"	36"	13.5"
WEA-9374-3-03	60"	42"	13.5"
WEA-9375-3-03	60"	52"	13.5"
WEA-9376-3-03	60"	60"	13.5"

SHELF BACK PANELS

PART NO.	LENGTH	HEIGHT
WEA-9603-3-02	36"	8.5"
WEA-9604-3-02	42"	8.5"
WEA-9605-3-02	52"	8.5"
WEA-9606-3-02	60"	8.5"

SECURE STORAGE UNITS

Select the shelf unit to fit your van, then the storage module to fit your needs.

- No wasted space below or between drawers
- Box construction strengthens and rigidizes shelf unit
- Modules bolt to end panels for fast and easy assembly
- Heavy-duty locking mechanism
- Includes one fully hemmed top shelf for extra strength and durability
- Brite White ARMOR-TUF® Powder coat finish
- Tapered end panel for a closer fit to the van wall
- Floor clearance for drawer units and supplies



WEA-9381-3-03
Shown with WEA-9040-3-01
Door Module

5 Drawer Module

FULL SIZE VANS

PART NO.	HEIGHT	WIDTH	DIVIDERS	WEIGHT
WEA-9381-3-03	44"	42"	8	104 lbs.

HIGH ROOF VANS

PART NO.	HEIGHT	WIDTH	DIVIDERS	WEIGHT
WEA-9391-3-03	60"	42"	12	108 lbs.

STORAGE MODULE ONLY (for 42" wide shelf units)

PART NO.	DESCRIPTION	WEIGHT
WEA-9040-3-01	Door Module	47 lbs.
WEA-9045-3-03	5 Drawer Module	78 lbs.



VAN SOLUTIONS

MECHANICS GRADE TOOL CABINETS

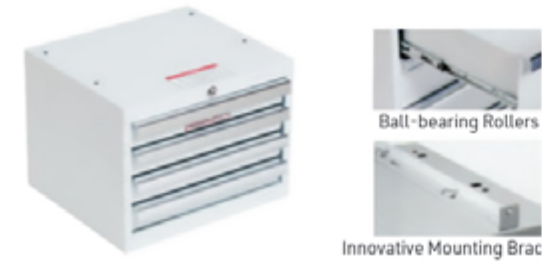

High quality and durable mechanics grade tool cabinets for your van features easy-to-grip handles, and smooth ball-bearing rollers. Great for your shop too!

PART NO.	DRAWERS	HEIGHT	WIDTH	DEPTH
WEA-9914-3-02	4	12"	16"	13.7"

PARTS BIN BOXES



Having the parts you need for a day's work is a lot easier with these sturdy part boxes. Keep spare boxes filled in your shop so the crew is ready to roll in the morning.

PART NO.	DRAWERS	HEIGHT	WIDTH	DEPTH
WEA-9909-3-02	9	12"	17"	12"
WEA-9924-3-02	4	24"	16"	14"

FILE BOXES

File Boxes mount between the seats of Full-size vans and Minivans and are designed for holding hanging file folders.

Features include:
a clipboard clamp, a keyed lock and sliding tray and a quick release mounting plate, allowing the box to be removed from the van



PART NO.	MODEL	HEIGHT	WIDTH	DEPTH
WEA-9012-3-01	Full-size Vans	12"	13"	20"

RAPID MOUNT™ SHELVING

Designed FOR THE WAY YOU WORK™, Weather Guard® Rapid Mount™ Shelving takes it to the max! Maximum customization and capacity, for maximum productivity. Shelves can be adjusted quickly without tools, using new cam handles. Assembly and installation is faster and easier than before. Tapered end panels and notched base maximize floor clearance for drawer units or supplies.

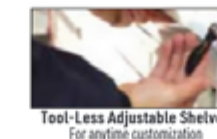

Tool-Less Adjustable Shelves
For anytime customization



End Caps
For material storage & load tie down



Deeper 16"
Fully Hemmed Shelves sized for tools, equipment and other materials

EASY TO CUSTOMIZE
With pre-punched mounting holes for WEATHER GUARD® accessories and adjustable dividers

FLOOR CLEARANCE
For drawer units and supplies

17" TAPERED END PANEL
For a closer fit to the van wall

UNMATCHED DURABILITY
Achieved with heavy duty 18 gauge steel construction

FULL SIZE VAN SHELF UNITS

PART NO.	HEIGHT	WIDTH	DEPTH	DIVIDERS
WEA-9345-3-03	46"	52"	16"	8**
WEA-9346-3-03*	46"	60"	16"	8**

Footnotes:

- * Shelf Center Support included with 60" wide shelving units
- ** Four 16" Standard Dividers and four 13" Narrow Dividers Included with each shelving unit.

RAPID MOUNT™ ACCESSORIES

SHELF DOORS WITH HIGH SECURITY D HANDLE LOCK

PART NO.	HEIGHT	WIDTH
WEA-9504-3-01	10.5"	42"
WEA-9505-3-01	10.5"	52"

LIGHT WEIGHT SHELF BACK PANELS - lightweight finished appearance

PART NO.	HEIGHT	WIDTH
WEA-9604-3-02	13.5"	42"



weather guard STEEL TRUCK RACK



INSTALLS IN 1hr

FULL SIZE STEEL TRUCK RACK



- FEATURES:**
- Fits all full size trucks
 - Matte black finish
 - Compatible with Weather Guard truck boxes

1000 lb. weight rated evenly distributed **WEA-1275-52-02**

1700 lb. weight rated evenly distributed **WEA-1175-52-02**



WELDED AIRFOIL INCLUDED
No need to purchase an accessory, helps deflect wind.



NO-DRILL INSTALL
Installs in less than an hour. (15-20 min to assemble/ 30 minutes to install)



MAXIMUM TIE-DOWN POINTS
4 areas allow for additional tie-down points on rack legs for items on rack.

ACCESSORIES

WEA-1059-52-01 Cab Protector

- 1 - Visibility of tail light when cab protector is installed
- 2 - Mounting points line up with pre-drilled holes on Steel Truck Rack front legs
- 3 - Matte Black Finish - matches steel truck rack

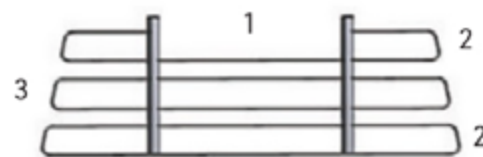

WEA-1290-52-01 Accessory Cross Member

- 1 - Same diameter tubing as Steel Truck Rack
- 2 - Matte Black Finish - matches Steel Truck Rack
- 3 - Easily adjusts based on load being carried on Steel Truck Rack
- 4 - No-Drill installation utilizes locking pins (same as rear cross member on rack)



PART NO.	MODEL	LENGTH	WIDTH	HEIGHT	WEIGHT
WEA-1275-52-02	Full Size Steel Truck Rack	154"	58"	35"	142 lbs
WEA-1059-52-01	Cab Protector	65"	2"	22"	61 lbs
WEA-1290-52-01	Accessory Cross Member	59"	3"	3"	16 lbs

WESTIN HDX HEADACHE RACK

- Vehicle specific applications
- Protects rear window
- Welded tie-off hooks
- Angled louvers
- 4 mounting tabs for lights or accessories
- Accommodates most major brand tool boxes
- 2" dia. round top tube facilitates cargo positioning
- Complete with bracket mount kit and hardware
- Can be used in conjunction with HDX Ladder Rack

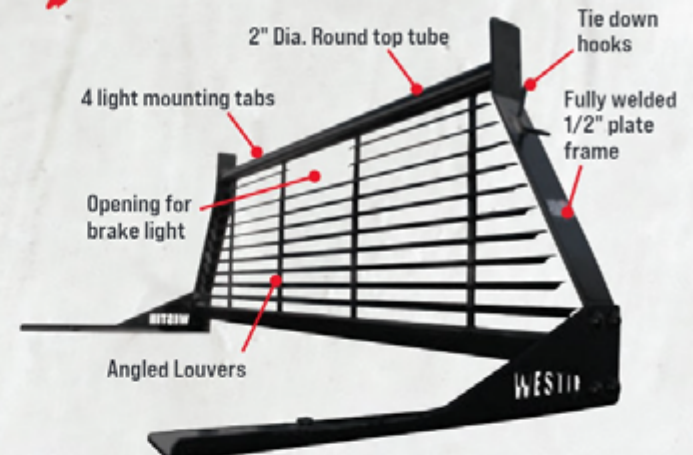

YEAR	MODEL	TOOL BOX FITMENT	BLACK	WHITE
CHEVROLET/GMC				
07-23	Silverado/Sierra 2500/3500 ⁴	Up to 70" Wide	WES-57-8025	WES-57-8023
07-23	Silverado/Sierra 1500 ⁴	Up to 70" Wide	WES-57-8025	WES-57-8023
99-06	Silverado/Sierra 1500/2500/3500 ⁴	Up to 70" Wide	WES-57-8025	WES-57-8023
DODGE/RAM				
02-23	Ram 1500 & 10-23 2500/3500 ⁴	Up to 71" Wide	WES-57-8035	WES-57-8033
FORD				
08-22	Super Duty ⁴	Up to 72" Wide	WES-57-8005	WES-57-8003
09-23	F150 ⁴	Up to 70" Wide	WES-57-8025	WES-57-8023
TOYOTA				
07-21	Tundra ⁴	Up to 71" Wide	WES-57-8025	WES-57-8023

Footnotes
4 Mount kit WES-57-8093 (White) or WES-57-8095 (Black) may be used to accommodate larger tool boxes

HD OVERHEAD TRUCK RACK



FINISH: Textured Black
MATERIAL: E-Coated Steel
WARRANTY: 3 Year

- Adjustable center cross bar included with each rack
- Made of 2" diameter tube
- Slotted leg mounts adjust to fit all models
- Full bed rail mounting plate included
- Optional hold-down clamps brackets sold separately



YEAR	MODEL	BLACK
CHEVROLET/GMC		
01-19	Silverado/Sierra 2500/3500 8'	WES-57-6005
99-23	Silverado/Sierra 1500 8'	WES-57-6005
DODGE/RAM		
03-23	Ram 2500/3500 8'	WES-57-6005 ¹
02-23	Ram 1500 8'	WES-57-6005 ¹
FORD		
04-23	F150 8'	WES-57-6005

FOOTNOTES: 1 - Excludes models with RamBox

PUTCO HEADACHE RACKS

BOSS RACK



Lights Sold Separately!

ALL ALUMINUM CONSTRUCTION

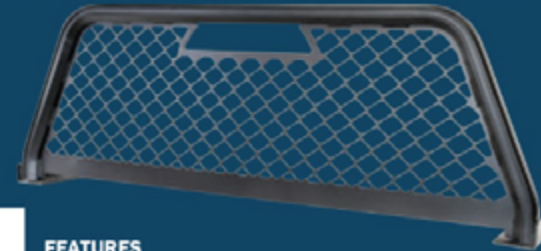

YEAR	MODEL	BLACK PART NO.
CHEVROLET		
20-23	Silverado/Sierra HD	PUT-89057
15-19	Silverado/Sierra HD	PUT-89027
19-23	Silverado/Sierra 1500	PUT-89055
14-18	Silverado/Sierra 1500	PUT-89025
DODGE/RAM		
10-23	Ram 2500/3500	PUT-89040
19-23	Ram 1500	PUT-89041
09-18	Ram 1500 & 19-23 1500 Classic	PUT-89039
FORD		
17-22	Super Duty	PUT-89051
15-23	F150	PUT-89046
NISSAN		
15-21	Titan XD	PUT-89032
TOYOTA		
07-21	Tundra	PUT-89037

FEATURES

- Putco exclusive patent pending extrusion tube
- CNC 7 axis bending for exact vehicle cab contour
- Custom 3 axis CNC center plate pattern with exact third brake light opening
- Ready built to integrate a Putco LED Work Blade (sold separately)
- Black Powder coat finish
- Lightweight and strong 6061 T6 Aluminum construction
- Narrow mounting brackets for discrete installation utilizing stake bed pockets
- Works with all inside the rail tonneau covers
- Backed by Putco's Multi-Year warranty on material defects and failure

WORKS WITH EXISTING LOCKER RAILS & TONNEAU COVERS



100% MADE IN THE USA



ANGULAR ALUMINUM CAB RACKS



- A** Use 2 racks to transport longer items
- B** Integrated channel system offers many accessory possibilities
- C** 2.5" hexagonal aluminum tubing
- D** Welded mounting feet install into existing stake pocket holes
- E** Heavy-duty ultra mesh (front) or open frame (rear)

YEAR	MODEL	FRONT WITH MESH TEXTURED BLACK	BACK NO MESH TEXTURED BLACK
CHEVROLET/GMC			
73-23	Silverado/Sierra	DEE-95090TB	DEE-95094TB
DODGE/RAM			
10-23	Ram 2500/3500	DEE-95098TB	DEE-95094TB
09-23	Ram 1500 & 19-23 1500 Classic	DEE-95090TB	DEE-95094TB
FORD			
17-22	Super Duty	DEE-95092TB	DEE-95093TB
73-23	F150	DEE-95090TB	DEE-95094TB
TOYOTA			
07-21	Tundra	DEE-95090TB	-

ALUMINUM CAB RACKS



- Curved design creates a sleek look, constructed of 2.75" extruded aluminum tubing
- Bolt-together mounting bracket design reduces shipping dimensions without compromising strength
Mounting brackets included
- Integrated channel system offers many accessory possibilities - set of two tie downs included
- Use two racks for longer items such as ladders
- Powder coated silver or textured black
- No-drill installation into bed's stake pockets.
- 300lb. limit with one rack, 500lb. limit with two

YEAR	MODEL	FRONT W/ MESH TEXTURED BLACK	FRONT W/ MESH ALUMINUM	FRONT W/O MESH TEXTURED BLACK	FRONT W/O MESH ALUMINUM	REAR RACK TEXTURED BLACK	REAR RACK ALUMINUM
CHEVROLET/GMC							
73-23	Silverado/Sierra	DEE-95050RTB	DEE-95050R	DEE-95054RTB	DEE-95054R	DEE-95054RTB	DEE-95054R
DODGE/RAM							
10-23	Ram 2500/3500	DEE-95058RTB	DEE-95058R	-	-	DEE-95054RTB	DEE-95054R
09-23	Ram 1500	DEE-95050RTB	DEE-95050R	DEE-95054RTB	DEE-95054R	DEE-95054RTB	DEE-95054R
FORD							
17-22	Super Duty	DEE-95072RTB	DEE-95072R	-	-	-	-
73-23	F150	DEE-95050RTB	DEE-95050R	DEE-95054RTB	DEE-95054R	DEE-95054RTB	DEE-95054R
TOYOTA							
07-21	Tundra	DEE-95050RTB	DEE-95050R	DEE-95054RTB	DEE-95054R	DEE-95054RTB	DEE-95054R

CAB RACK LIGHT BARS

DEE-95063 Cab Rack Light Mounting Kit Texture Black
L = 14.275"
W = 9"
H = 1.075"



OPTIONAL TIE DOWNS

DEE-95002 Cab Rack Tie Down Kit





HEX SERIES TRUCK RACK



- Constructed of hexagonal aluminum tubing
- Available in Gloss Silver or Textured Black finish
- Integrated channels to add endless accessory options
- Adjustable cross bars for ideal arrangement



YEAR	MODEL	GLOSS SILVER	TEXTURED BLACK
CHEVROLET/GMC			
07-23	Silverado/Sierra 1500 & 07-23 HD	DEE-95250	DEE-95250TB
DODGE/RAM			
10-23	Ram 2500/3500	DEE-95251	DEE-95251TB
09-18	Ram 1500 & 19-23 1500 Classic	DEE-95251	DEE-95251TB
FORD			
16-22	Super Duty	DEE-95253	DEE-95253TB
15-23	F150	DEE-95252	DEE-95252TB

UNIVERSAL CROSS RAILS



DEE Zee designed Hex Cross Rails with customization in mind and they can be mounted on midsize and full-size trucks. The universal bracket attaches to the lip of the truck bed and can be mounted anywhere along the rail. The hexagonal tubing includes integrated channels to mount various accessories.

- An easy way to add anchors for securing cargo
- Made from cast aluminum
- No drilling required
- Sold in pairs

FEATURES

- Made of Hexagonal Extruded Aluminum
- Texture black powder coat for style and protection
- Lightweight, yet durable with 200-pound weight capacity
- Can be mounted anywhere along the bed rail and spaced for your needs
- Easy removal with hand knobs when not in use
- Durable Plastic End Caps
- No Drilling Required for Easy Installation
- Channels Add Endless Accessory Options (not included)
- Limited-Lifetime Warranty

DESCRIPTION	PART NO.
Full-Size Trucks	DEE-99781TB
Mid-Size Trucks	DEE-99780TB
INSTALL KITS	
Toyota Track Kit	DEE-99780BPT
Nissan Track Kit	DEE-99780BPN
ACCESSORIES	
Tie Down Anchor Kit - 2pcs	DEE-97903



**QUALITY, DELIVERED ON TIME!
HEADACHE RACK**

Building on our reputation for the highest quality and design in the Truck & Jeep market, the Fab Fours Headache Rack focuses on strength, durability and safety.



FEATURES:

- 1) Fab Fours Signature Knife Edge Lines
- 2) Simple Design
- 3) Accepts RIGID 2x2 Dually Lights
- 4) Matches Fab Fours Flat Black Powder Coat
- 5) Constructed Out of 12 Gauge Steel
- 6) Rear Brake Light Visibility
- 7) Easily Bolts on to Truck Bed



YEAR	MODEL	PART NO.	YEAR	MODEL	PART NO.
CHEVROLET/GMC			FORD		
07-18	Silverado/Sierra 1500 & 07-19 HD	FFR-HR2000-1	17-22	Super Duty	FFR-HR2012-1
DODGE/RAM			99-16	Super Duty	FFR-HR2005-1
13-16	Ram 1500	FFR-HR2013-1	15-20	F150	FFR-HR2009-1
03-12	Ram 1500 & 03-18 2500/3500	FFR-HR2002-1	TOYOTA		
			07-21	Tundra	FFR-HR2008-1



AdvantEDGE™ HEADACHE RACKS

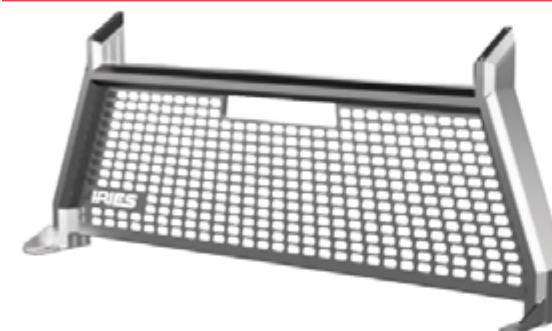

- Unique, eight-sided tube profile to complement the style of modern trucks
- Track on the top edge accepts lights, tie-down anchors or other accessories
- Extruded, T6 aluminum alloy construction to be strong, lightweight and rust-free
- Stamped aluminum, octagonal grid center section for a distinct look
- Stake pocket mounting system for simple, secure installation
- Complements other ARIES AdvantEDGE™ accessories
- Available in a Chrome Powder Coat or Carbide Black Powder Coat finish
- Five year warranty

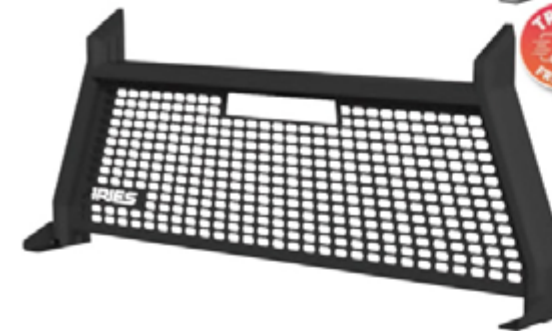

YEAR	APPLICATION	BED	CARBIDE BLACK PART NO.	CHROME PART NO.
CHEVROLET/GMC				
07-19	Silverado/Sierra 2500/3500	6'6"	ARI-1110104	ARI-1110204
07-19	Silverado/Sierra 2500/3500	8'	ARI-1110105	-
07-18	Silverado/Sierra 1500	ALL	ARI-1110104	ARI-1110204
DODGE/RAM				
07-23	Ram 3500	6'4"/8'	ARI-1110101	ARI-1110201
13-23	Ram 2500	6'4"/8'	ARI-1110101	ARI-1110201
19-23	Ram 1500 (not Rambox)	ALL	ARI-1110104	ARI-1110204
09-18	Ram 1500 & 19-23 Classic	ALL	ARI-1110101	ARI-1110201
FORD				
17-22	Super Duty F250/F350	6'9"/8'	ARI-1110107	ARI-1110207
99-16	Super Duty F250/F350	6'9"/8'	ARI-1110103	-
15-20	F150	ALL	ARI-1110102	ARI-1110202

...for a unique look and easy customization

BACKRACK™

FUNCTION AND STYLE FOR TODAY'S TRUCKS

TRACE RACK

The TRACE Rack provides the legendary protection BACKRACK is known for, now built with a sensational style all its own. Made from sturdy 14-gauge black powder-coated steel, the rack features a sculpted design that establishes a backbone of grit and determination. An optional Cab Shield is available to enhance protection for both cab and passengers and creates a total rack solution. And the TRACE Rack's innovative design really drives it home with a simple no-drill installation and our BACKRACK 1-Year Workmanship Warranty.

Predrilled holes to mount lighting and wire tie down points

Removable side panel for customization - wrap, powder coat, company logo, etc.



- MADE FROM QUALITY STEEL
- MAXIMUM CORROSION RESISTANCE
- NO DRILL INSTALLATION
- COMPATIBLE WITH SELECT TONNEAU COVERS

TRACE RACK		TRACE RACK PART NO.	SAFETY SCREEN PART NO.
CHEVROLET/GMC			
19-23	Silverado/Sierra 1500	BAC-TR9002	BAC-SC9002
DODGE/RAM			
19-23	Ram 1500	BAC-TR9003	BAC-SC9003
FORD			
15-23	F150	BAC-TR9001	BAC-SC9001

BACKRACK™

FUNCTION AND STYLE FOR TODAY'S TRUCKS

THE ONE, THE ONLY ORIGINAL BACKRACK™

- ✓ TONNEAU COVER COMPATIBLE
- ✓ PARK IN YOUR GARAGE
- ✓ NO DRILL INSTALLATION
- ✓ CARRY LONG LOADS WITH EASE
- ✓ MOUNT LIGHTS AND ACCESSORIES
- ✓ NORTH AMERICAN QUALITY

Same Great Product, Now Available In White By Special Order!

BACKRACK



- Sleek Design & Clean Lines for Great Looks
- Compatible with Select Tonneau Covers
- Low Profile allows Low Clearance Access
- Bolt-on Accessories to Mount Lights, etc.
- Strong & Rigid with No Drill Installation
- Carry Ladders & Secure Cargo with Style

SAFETYRACK

Standard



- Complete Window Protection
- Full Width Cargo Carrying Capacity
- 3/16" Cold Rolled Wire Mesh Insert

Toolbox

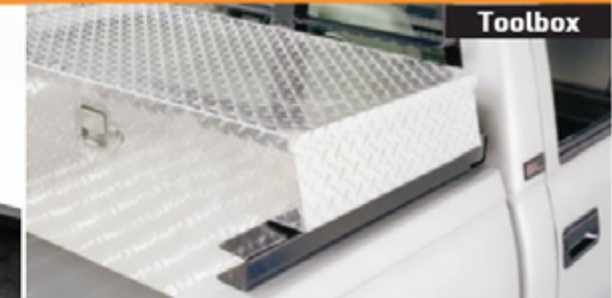

- Heavy Gauge 2" Tubular Construction
- Durable Powder Coat Finish
- Compatible with Select Tonneau Covers

LOUVERED RACK



REAR BAR



See complete application guide on next page →

BACKRACK™

FUNCTION AND STYLE FOR TODAY'S TRUCKS

APPLICATION GUIDE

YEAR	MODEL	CHOOSE YOUR CAB GUARD FRAME			CHOOSE YOUR HARDWARE KIT		OPTIONAL ACCESSORIES
		BACKRACK FRAME ONLY	SAFETY RACK FRAME ONLY	LOUVERED FRAME ONLY	NO DRILL STANDARD	NO DRILL W/21" TOOLBOX	
CHEVROLET/GMC							
20-23	Silverado/Sierra HD	BAC-15020	BAC-10800	BAC-12800	BAC-30124	-	BAC-11524
19-23	Silverado/Sierra 1500	BAC-15019	BAC-10900	BAC-12900	BAC-30122	BAC-30122TB	BAC-11522
14-18	Silverado/Sierra 1500 (Incl. 14-19 HD)	BAC-15004	BAC-10900	BAC-12900	BAC-30119	BAC-30119TB	BAC-11520
07-13	Silverado/Sierra 1500 (Incl. 14 HD)	BAC-15004	BAC-10900	BAC-12900	BAC-30119	BAC-30119TB	BAC-11519
99-06	Silverado/Sierra 1500 (Incl. HD)	BAC-15003	BAC-10800	BAC-12800	BAC-30109	BAC-30109TB	-
15-22	Colorado/Canyon	BAC-15002	BAC-10600	-	BAC-30126	BAC-30126TB	-
DODGE/RAM							
10-23	Ram 2500/3500 (not RamBox)	BAC-15020	BAC-10800	BAC-12800	BAC-30117	BAC-30117TB	BAC-11517
12-18	Ram 2500/3500 (w/ RamBox)	BAC-15017	-	-	BAC-30147	-	-
03-09	Ram 2500/3500	BAC-15020	BAC-10800	BAC-12800	BAC-30117	BAC-30117TB	BAC-11517
19-23	Ram 1500 *	BAC-15020	BAC-10800	BAC-12800	BAC-30167	BAC-30167TB	BAC-11527
12-18	Ram 1500 & 19-23 1500 Classic 6'4" (w/ RamBox)	BAC-15017	-	-	BAC-30147	-	-
09-18	Ram 1500 & 19-23 1500 Classic 5'7" (w/ RamBox)	BAC-15017	-	-	BAC-30147	-	-
09-18	Ram 1500 & 19-23 1500 Classic 6'4" (not RamBox)	BAC-15020	BAC-10800	BAC-12800	BAC-30117	BAC-30117TB	BAC-11517
09-18	Ram 1500 & 19-23 1500 Classic 5'7" (not RamBox)	BAC-15020	BAC-10800	BAC-12800	BAC-30127	BAC-30117TB	BAC-11527
02-08	Ram 1500	BAC-15020	BAC-10800	BAC-12800	BAC-30117	BAC-30117TB	BAC-11517
05-11	Dakota	BAC-15016	-	-	BAC-30113	BAC-30113TB	-
FORD							
17-22	Super Duty	BAC-15018	BAC-10700	BAC-12700	BAC-30221	BAC-30221TB	BAC-11523
99-16	Super Duty	BAC-15018	BAC-10700	BAC-12700	BAC-30201	BAC-30201TB	BAC-11501
15-23	F150	BAC-15004	BAC-10900	BAC-12900	BAC-30123	BAC-30123TB	BAC-11523
04-14	F150	BAC-15004	BAC-10900	BAC-12900	BAC-30112	BAC-30112TB	BAC-11512
19-22	Ranger	BAC-15002	BAC-10600	-	BAC-30331	BAC-30331TB	-
22-23	Maverick	BAC-15032	-	-	BAC-30150	-	-
NISSAN							
16-21	Titan	BAC-15004	BAC-10900	BAC-12900	BAC-30113	BAC-30113TB	-
04-15	Titan	BAC-15003	BAC-10800	-	BAC-30511	-	-
TOYOTA							
22-23	Tundra	BAC-15004	BAC-10900	-	BAC-30228	BAC-30228TB	-
08-21	Tundra	BAC-15004	BAC-10900	-	BAC-30118	BAC-30118TB	-
05-23	Tacoma	BAC-15010	BAC-10200	-	BAC-30327	-	-

Footnote: 1 - Backracks are not compatible with Multi-Function Tailgates

SIDE RAILS

- Industrial Strength & Work Ready
- Great Looks to Match our Cab Guards
- No Drill Installation
- E-Coat Base Finish - Powder Coat
- Toolbox & No Toolbox Applications
- Installs With or Without Cab Guards



YEAR	MODEL	5.5' BED		6.5' BED		8' BED	
		STANDARD	w/ 21" TOOLBOX	STANDARD	w/ 21" TOOLBOX	STANDARD	w/ 21" TOOLBOX
CHEVROLET/GMC							
20-23	Silverado/Sierra HD	-	-	BAC-65524	BAC-65524TB	BAC-80524	BAC-80524TB
19-23	Silverado/Sierra 1500	BAC-55522	BAC-55522TB	BAC-65522	BAC-65522TB	BAC-80524	BAC-80524TB
14-18	Silverado/Sierra 1500 & 14-19 HD	BAC-55520	BAC-55520TB	BAC-65520	BAC-65520TB	BAC-80520	BAC-80520TB
07-13	Silverado/Sierra	BAC-55519	BAC-55519TB	BAC-65519	BAC-65519TB	BAC-80519	BAC-80519TB
99-06	Silverado/Sierra	-	-	BAC-65509	-	-	-
DODGE/RAM							
03-23	Ram 2500/3500	-	-	BAC-65517	BAC-65517TB	BAC-80517	BAC-80517TB
19-23	Ram 1500	-	-	BAC-65567	BAC-65567TB	BAC-80567	BAC-80567TB
02-18	Ram 1500 & 19-23 1500 Classic	-	-	BAC-65517	BAC-65517TB	BAC-80517	BAC-80517TB
FORD							
17-22	Super Duty	-	-	BAC-65521	BAC-65521TB	BAC-80521	BAC-80521TB
99-16	Super Duty	-	-	BAC-65501	BAC-65501TB	BAC-80501	BAC-80501TB
15-23	F150	BAC-55523	BAC-55523TB	BAC-65523	BAC-65523TB	BAC-80523	BAC-80523TB
04-14	F150	-	-	BAC-65512	BAC-65512TB	BAC-80512	BAC-80512TB

BACKRACK™

FUNCTION AND STYLE FOR TODAY'S TRUCKS

THREE LIGHT

HALF SAFETY



LIGHTS SOLD SEPARATELY
SEE BOTTOM OF PAGE

HALF LOUVERED

THREE ROUND



Same Great Product, Now Available In White By Special Order!

APPLICATION GUIDE

YEAR	MODEL	CHOOSE YOUR CAB GUARD FRAME				CHOOSE YOUR HARDWARE KIT	
		THREE LIGHT FRAME ONLY	HALF SAFETY FRAME ONLY	HALF LOUVERED FRAME ONLY	THREE ROUND FRAME ONLY	NO DRILL STANDARD	NO DRILL w/ 21" TOOLBOX
CHEVROLET/GMC							
20-23	Silverado/Sierra 2500HD/3500HD	BAC-148TL	BAC-148SM	BAC-148LV	BAC-148TR	BAC-30124	-
19-23	Silverado/Sierra 1500	BAC-149TL	BAC-149SM	BAC-149LV	BAC-149TR	BAC-30122	BAC-30122TB
14-18	Silverado/Sierra 1500 (15-19 HD)	BAC-149TL	BAC-149SM	BAC-149LV	BAC-149TR	BAC-30119	BAC-30119TB
07-13	Silverado/Sierra 1500 (07-14 HD)	BAC-149TL	BAC-149SM	BAC-149LV	BAC-149TR	BAC-30119	BAC-30119TB
99-06	Silverado/Sierra 1500 (Incl. HD)	BAC-149TL	BAC-149SM	BAC-149LV	BAC-149TR	BAC-30109	BAC-30109TB
DODGE/RAM							
03-23	Ram 2500/3500 (not RamBox)	BAC-148TL	BAC-148SM	BAC-148LV	BAC-148TR	BAC-30117	BAC-30117TB
19-23	Ram 1500	BAC-148TL	BAC-148SM	BAC-148LV	BAC-148TR	BAC-30167	BAC-30167TB
02-18	Ram 1500 & 19-23 1500 Classic (not RamBox)	BAC-148TL	BAC-148SM	BAC-148LV	BAC-148TR	BAC-30117	BAC-30117TB
09-18	Ram 1500 & 19-23 1500 Classic 5.5' (not RamBox)	BAC-148TL	BAC-148SM	BAC-148LV	BAC-148TR	BAC-30127	BAC-30117TB
FORD							
17-22	Super Duty	BAC-147TL	BAC-147SM	BAC-147LV	BAC-147TR	BAC-30221	BAC-30221TB
99-16	Super Duty	BAC-147TL	BAC-147SM	BAC-147LV	BAC-147TR	BAC-30201	BAC-30201TB
15-23	F150	BAC-149TL	BAC-149SM	BAC-149LV	BAC-149TR	BAC-30123	BAC-30123TB
04-14	F150	BAC-149TL	BAC-149SM	BAC-149LV	BAC-149TR	BAC-30112	BAC-30112TB
NISSAN							
16-21	Titan	BAC-149TL	BAC-149SM	BAC-149LV	BAC-149TR	BAC-30113	BAC-30113TB
04-15	Titan	BAC-148TL	BAC-148SM	BAC-148LV	BAC-148TR	BAC-30511	-
TOYOTA							
22-23	Tundra	BAC-149TL	BAC-149SM	BAC-149LV	BAC-149TR	BAC-30228	BAC-30228TB
08-21	Tundra	BAC-149TL	BAC-149SM	BAC-149LV	BAC-149TR	BAC-30118	BAC-30118TB

- Compatible with select Tonneau Covers with purchase of optional adapter (see page 417)
- Compatible with Side rails (see page 415)

LIGHT KIT FOR THREE LIGHT RACK - 6" Oval LED Lamps

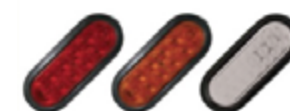

Lamps with Grommet & 3 Pronged Pigtail

COLOUR	PART NO.
Amber	UNI KTL2239-10A
Red	UNI KTL2239-10R
Clear	UNI KTL2239-10C

= Sold Individually =



BACKRACK™

FUNCTION AND STYLE FOR TODAY'S TRUCKS

TONNEAU COVER MOUNT KITS

Inside Rail Clamping Covers - 40XXX Series



- Designed for covers that clamp to the inside rail of the trucks bed rails.
- **40XXX Series Kits include everything required for installation except the BACKRACK™ Frame.**
- To order, select mount kit below, and then choose desired frame from page 415-416 (No Hardware req'd).
- Example: Louvered Rack for 2016 Sierra would require - BAC-40120 + BAC-15004.

Wide Top Rail Covers - 50XXX Series



- Designed for folding covers that sit on top of the trucks bed rails.
- **50XXX Series Kits include everything required for installation except the BACKRACK™ Frame.**
- To order, select mount kit below, and then choose desired frame from page 415-416 (No Hardware req'd).
- Example: Original Back Rack for 2016 Sierra would require - BAC-50120 + BAC-15004

TONNEAU COVER MOUNT KITS

YEAR	MODEL	40XXX SERIES*		50XXX SERIES*	
		MOUNT KIT	FRAME	MOUNT KIT	FRAME
CHEVROLET/GMC					
20-23	Silverado/Sierra HD	BAC-40124	BAC-15020	BAC-50124	-
19-23	Silverado/Sierra 1500	BAC-40122	BAC-15019	BAC-50122	-
14-18	Silverado/Sierra 1500 & 15-19 HD	BAC-40120	BAC-15004	BAC-50120	BAC-15024
07-13	Silverado/Sierra 1500 & 07-14 HD	BAC-40120	BAC-15004	-	-
99-06	Silverado/Sierra 1500 (incl. HD)	BAC-40109	BAC-15004	-	-
15-22	Colorado/Canyon	BAC-40126	BAC-15002	-	-
DODGE/RAM					
03-23	Ram 2500/3500 6'4" (not RamBox)	BAC-40117	BAC-15020	BAC-50117	-
19-23	Ram 1500 6.5' & 8'	BAC-40167	BAC-15020	BAC-50167	BAC-15026
09-18	Ram & 19-23 1500 Classic 5'7" (not RamBox)	BAC-40127	BAC-15020	BAC-50127	BAC-15026
02-18	Ram & 19-23 1500 Classic 6'4" (not RamBox)	BAC-40117	BAC-15020	BAC-50117	BAC-15026
FORD					
17-22	Super Duty	BAC-40221	BAC-15018	BAC-50221	BAC-15021
99-16	Super Duty	BAC-40201	BAC-15018	BAC-50201	BAC-15021
15-23	F150	BAC-40123	BAC-15004	BAC-50123	BAC-15024
04-14	F150	BAC-40112	BAC-15004	BAC-50112	BAC-15024
TOYOTA					
22-23	Tundra	-	-	BAC-50228	BAC-15024
08-21	Tundra	BAC-40118	BAC-15004	-	-
16-23	Tacoma	-	-	BAC-50327	BAC-15002

* IMPORTANT INFORMATION - PLEASE READ BEFORE ORDERING

- 40XXX Series Hardware increases over all frame height by 1"
- All BACKRACK™ frames are compatible with 40XXX & 50XXX but height increases 1"
- All BACKRACK™ frames for your truck are designed to sit near cab high with Standard Hardware

TONNEAU BRAND COMPATIBILITY CHART

BRAND	MODEL	SERIES	SERIES
Access	Original	40XXX	
Access	LoMax	40XXX	
BAK Industries	Revolver X2 & X4	40XXX	
BAK Industries	BakFlip	40XXX	
Extang	Solid Fold		50XXX
Extang	Trifecta		50XXX
Lund	Genesis Tri Fold		50XXX
Lund	Genesis Roll Up	40XXX	
Truxedo	Titanium & Sentry	40XXX	
Truxedo	LoPro & ProXT5	40XXX	
Undercover	Flex	40XXX	

ACCESSORIES



BAC-91002 - 10.5" Base Center Mount



BAC-91006 - "L" Brackets (pr)



BAC-42005 - Light Bar Bracket



BAC-41011 - Landscape Tool Holder Holds 11 Tools



BAC-81001 (Left) - 6.5" Base Drivers Side Bracket
BAC-91008 (Right) - Antenna Bracket



BAC-41000 - 10 1/2" x 11 1/2" Light Bracket



BAC-91007 (Left) - 16" x 7" Light Bracket
BAC-91004 (Center) - Arrow Stick "Z" Brackets (pr)
BAC-91005 (Right) - Sport Light "L" Brackets (pr)



BAC-91001 (Left) - 10.5" Base Drivers Side Mount
BAC-91002REC (Center) - 16" x 7" Center Mount Light Bracket
BAC-81003 (Right) - 6.5" Base Passenger Side Mount



BAC-41008 Buggy Whip Bracket

TOOLBOX BRACKETS

Toolbox Brackets are used to mount "over-the-rail" style toolboxes. Allows toolbox to be installed flush against BackRack. No drilling into truck bed. They are 21" in length. Brackets only, no fasteners included. Use fasteners provided with original hardware kit.

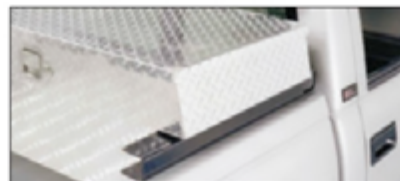

YEAR	APPLICATION	PART NO.
88-23	Silverado/Sierra	BAC-91010
94-18	Ram & 19-23 1500 Classic (not RamBox)	BAC-91010
17-22	Super Duty	BAC-91021
99-16	Super Duty	BAC-91011
15-23	F150	BAC-91023
04-14	F150	BAC-91013
08-21	Tundra	BAC-91010

ADARAC™

TRUCK BED RACK

TRUCK BED RACK SYSTEM



ADARAC™ TRUCK BED RACK

Taking performance and versatility to new heights. The ADARAC™ Truck Bed Rack effectively and efficiently extends the carrying capability of your truck with a sturdy framework constructed of durable powder coated steel. ADARAC™ Truck Bed Racks load capacity is maximum 1,000 lbs. static, 500 lbs. dynamic and 400 lbs. off-road dynamic, evenly distributed. Each aluminum cross bar features an integrated mounting channel to easily attach accessories and secure cargo. The easily adjustable and removable uprights contour to the cab for an aerodynamic design. The ADARAC™ Truck Bed Rack is strong, sturdy and stylish.

ADARAC™

ALUMINUM M-SERIES

TRUCK BED RACK SYSTEM

ADARAC™ ALUMINUM PRO SERIES

Industrial versatility with a strong emphasis on more. The ADARAC™ Aluminum Pro Series maximizes hauling power with limited framework interference for cargo and folding tonneau cover operation using completely adjustable and removable vertical uprights. Accessories can be quickly attached to safely secure gear using integrated mounting channels in the rails and cross bars. Heavy duty corrosion resistant aluminum construction. ADARAC™ Truck Bed Racks load capacity is maximum 1,000 lbs. static, 500 lbs. dynamic and 400 lbs. off-road dynamic, evenly distributed. ADARAC™ Aluminum Pro Series has the strength to get the job done.



**ALUMINUM PRO SERIES
NOW AVAILABLE IN
MATTE BLACK & SILVER!**



APPLICATION GUIDE

YEAR	MODEL	ADARAC™	SILVER ALUMINUM PRO	MATTE BLACK ALUMINUM PRO
CHEVROLET/GMC				
20-23	Silverado/Sierra HD 6'9"	ACC-F1020122	ACC-F2020121	ACC-F2020122
20-23	Silverado/Sierra HD 8'	-	-	ACC-F2020132
15-19	Silverado/Sierra HD 6'6"	ACC-F1020052	ACC-F2020051	ACC-F2020052
15-19	Silverado/Sierra HD 8'	ACC-F1020062	ACC-F2020061	ACC-F2020062
01-14	Silverado/Sierra HD 6'6"	ACC-F1020022	ACC-F2020021	-
19-23	Silverado/Sierra 1500 5'8"	ACC-F1020092	ACC-F2020091	ACC-F2020092
19-23	Silverado/Sierra 1500 6'6"	-	ACC-F2020101	ACC-F2020102
19-23	Silverado/Sierra 1500 8'	-	-	ACC-F2020112
14-18	Silverado/Sierra 1500 5'8"	ACC-F1020042	ACC-F2020041	ACC-F2020042
14-18	Silverado/Sierra 1500 6'6"	ACC-F1020052	ACC-F2020051	ACC-F2020052
14-18	Silverado/Sierra 1500 8'	ACC-F1020062	ACC-F2020061	ACC-F2020062
04-13	Silverado/Sierra 1500 5'8"	ACC-F1020012	ACC-F2020011	-
99-13	Silverado/Sierra 1500 6'6"	ACC-F1020022	ACC-F2020021	-
15-22	Colorado/Canyon 5'	-	ACC-F2020071	ACC-F2020072
15-22	Colorado/Canyon 6'	-	ACC-F2020081	ACC-F2020082
DODGE/RAM				
03-23	Ram 2500/3500 6'4"	ACC-F1040022	ACC-F2040021	ACC-F2040022
03-23	Ram 2500/3500 8'	ACC-F1040032	ACC-F2040031	ACC-F2040032
09-23	Ram 1500 5'7" (w/o RamBox)	ACC-F1040012	ACC-F2040011	ACC-F2040012
02-23	Ram 1500 6'4"	ACC-F1040022	ACC-F2040021	ACC-F2040022
02-23	Ram 1500 8'	ACC-F1040032	ACC-F2040031	ACC-F2040032
FORD				
17-22	Super Duty 6'9"	ACC-F1010042	ACC-F2010041	ACC-F2010042
17-22	Super Duty 8" (incl. Dually)	ACC-F1010062	ACC-F2010061	ACC-F2010062
99-16	Super Duty 6'9"	ACC-F1010032	ACC-F2010031	-
99-16	Super Duty 8" (incl. Dually)	ACC-F1010052	ACC-F2010051	-
04-23	F150 5'6"	ACC-F1010012	ACC-F2010011	ACC-F2010012
97-23	F150 6'6"	ACC-F1010072	ACC-F2010071	ACC-F2010072
97-23	F150 8'	ACC-F1010022	ACC-F2010021	ACC-F2010022
19-23	Ranger 5'	-	ACC-F2010081	ACC-F2010082
19-23	Ranger 6'	-	ACC-F2010091	ACC-F2010092
TOYOTA				
22-23	Tundra 6'6"	-	ACC-F2050071	ACC-F2050072
07-21	Tundra 5'6"	-	ACC-F2050011	ACC-F2050012
07-21	Tundra 6'6"	-	ACC-F2050021	ACC-F2050022
07-21	Tundra 8'	-	ACC-F2050031	ACC-F2050032
16-23	Tacoma 5'	-	ACC-F2050041	ACC-F2050042
16-23	Tacoma 6'	-	ACC-F2050051	ACC-F2050052



ADARAC SERIES



ADARAC ALUMINUM PRO SERIES



TRUCK BED RACK SYSTEM

ADARAC™ ALUMINUM M-SERIES



COVER COMPATIBILITY

Works with Access® Roll-Up Covers and most inside the rail roll up tonneau covers.



TROUBLE-FREE INSTALLATION

Aluminum stake pocket inserts, no drilling required.

Great things do come in small packages! The ADARAC™ Aluminum M-Series is designed to make everything you do easier. From heavy duty, corrosion resistant aluminum to low profile, adjustable uprights the ADARAC™ Aluminum M-Series' load capacity is maximum 1,000 lbs. static, 500 lbs. dynamic and 400 lbs. off-road dynamic, evenly distributed. This model specific truck bed rack secures to your truck with aluminum stake pocket inserts for an easy, no drill installation. Quickly add accessories to secure cargo and prevent shifting with built-in mounting channels on cross bars and utility rails. ADARAC™ Aluminum M-Series increases the storage space and versatility of your pickup.



CORROSION RESISTANT FRAMEWORK

Support an evenly distributed 500 lb. load using extruded anodized aluminum rails combined with uprights and cross bars.

YEAR	MODEL	SILVER M-SERIES
CHEVROLET/GMC		
20-23	Silverado/Sierra HD 6'9"	ACC-F4020121
15-19	Silverado/Sierra HD 6'6"	ACC-F4020051
01-14	Silverado/Sierra HD 6'6"	ACC-F4020021
19-23	Silverado/Sierra 1500 5'8"	ACC-F4020091
19-23	Silverado/Sierra 1500 6'6"	ACC-F4020101
14-18	Silverado/Sierra 1500 5'8"	ACC-F4020041
14-18	Silverado/Sierra 1500 6'6"	ACC-F4020051
99-13	Silverado/Sierra 1500 6'6"	ACC-F4020021
15-22	Colorado/Canyon 5'	ACC-F4020071
15-22	Colorado/Canyon 6'	ACC-F4020081
DODGE/RAM		
03-23	Ram 2500/3500 6'4" (w/o RamBox)	ACC-F4040021
19-23	Ram 1500 5'7" (w/o RamBox)	ACC-F4040011
02-23	Ram 1500 6'4" (w/o RamBox)	ACC-F4040021
FORD		
17-22	Super Duty 6'9"	ACC-F4010041
08-16	Super Duty 6'9"	ACC-F4010031
04-23	F150 5'6"	ACC-F4010011
97-23	F150 6'6"	ACC-F4010071
19-23	Ranger 5'	ACC-F4010081
19-23	Ranger 6'	ACC-F4010091
JEEP		
20-23	Gladiator	ACC-F4070012 (Matte Black)
TOYOTA		
22-23	Tundra 6'6"	ACC-F4050071
07-21	Tundra 5'6"	ACC-F4050011
07-21	Tundra 6'6"	ACC-F4050021
16-23	Tacoma 5'	ACC-F4050041
16-23	Tacoma 6'	ACC-F4050051



MID-HEIGHT UPRIGHTS

Compact design, easily remove or reposition for larger load capacity.



CAB GUARD KIT (Set of 2)

ACC-4004028

ERICKSON TRUCK RACKS
MANUFACTURING LTD.

ALUMINUM TRUCK RACK



- Aluminum construction resists corrosion and makes this rack lightweight, yet strong
- Rack is in two sections so it will fit all box lengths
- Clamping system connects to bed rail (no drilling required)
- Fully adjustable load stops

ERI-07705



Assembled Dimensions: Length: 66.4"
Width: 12.6"
Height: 34"

Triangle Stop Dimensions: Length: 3.5"
Width: 7"
Height: 6.5"



STEEL TRUCK RACK



- Steel construction makes this rack strong and durable
- Rack is in two sections so it will fit all box lengths
- Clamping system connects to bed rail (no drilling required)
- Fully adjustable load stops

ERI-07706



Assembled Dimensions: Length: 78"
Width: 14.7"
Height: 33.5"

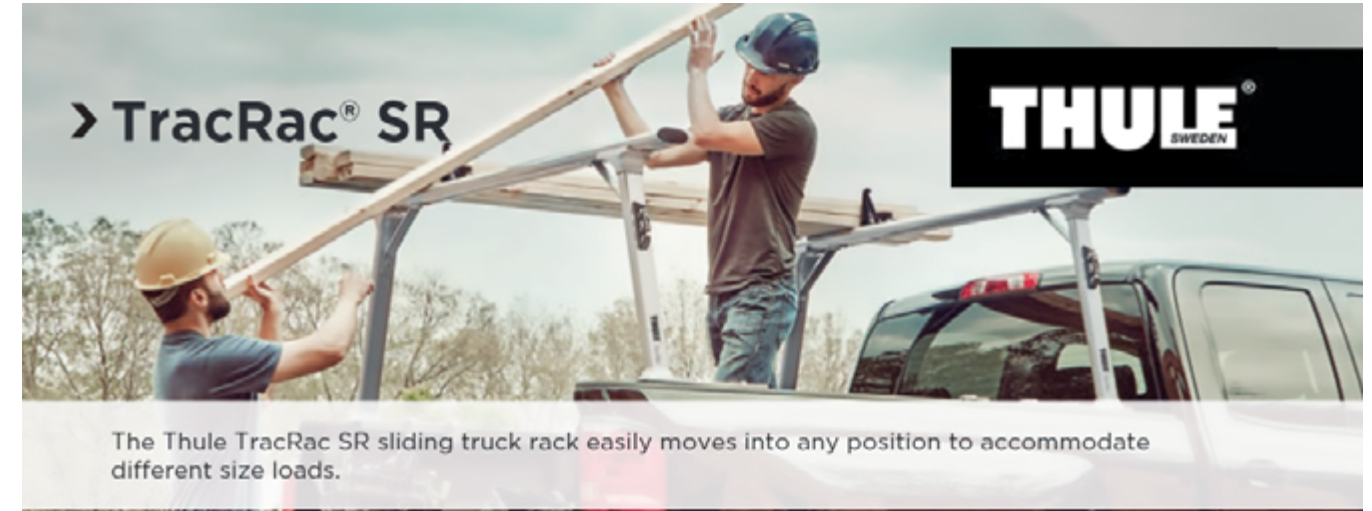

The Thule TracRac SR sliding truck rack easily moves into any position to accommodate different size loads.

TracRac SR | features

- Quick installation without drilling into the truck
- Aerodynamic and quiet due to the integrated wind deflectors
- Protect different size loads with the aluminum load stops that adjust to the full width of the truck
- Sliding racks adjust to the length of the bed to carry different loads and can easily be removed
- Securely transport all cargo with the aluminum ARC cleats that provide additional tie-down points
- Rack and cargo remain stable and secure due to corner brace design and aluminum crossbars
- Durable, corrosion resistant aluminum construction
- System weight: 80 lbs

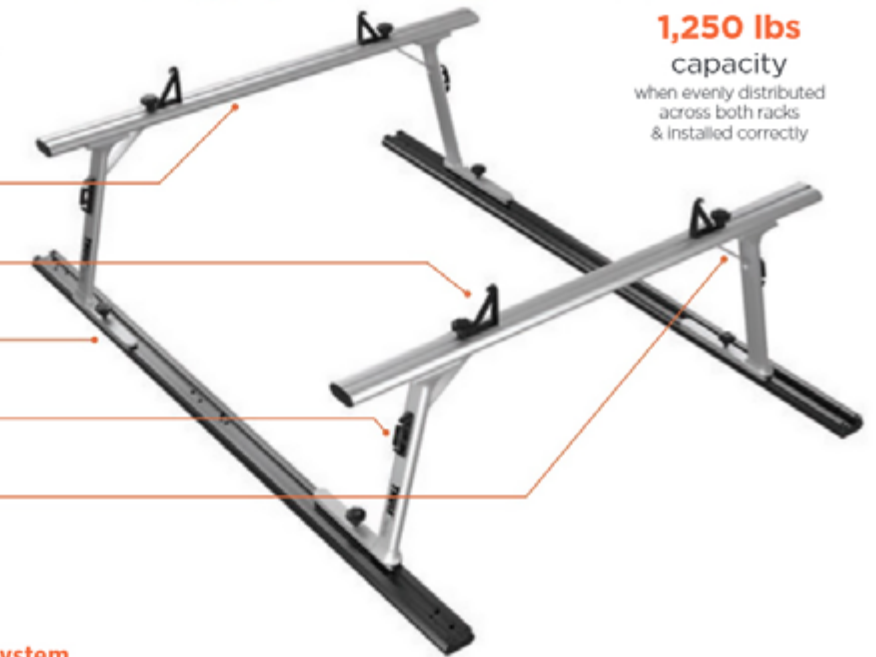

1,250 lbs capacity
when evenly distributed across both racks & installed correctly

For a complete TracRac SR system order appropriate Base Rails & Overhead Rack

- Base Rails include: (2) black anodized aluminum base rails and mounting hardware
- Overhead Racks include: front & rear sliding racks, (4) sliding aluminum crossbar tie-downs, and (4) aluminum ARC side cleats

YEAR	MODEL	BED	BASE RAILS	OVERHEAD RACK
CHEVROLET/GMC				
20-23	Silverado/Sierra HD	6'9"	THU-217870	THU-43002XT
14-23	Silverado/Sierra 1500 & 15-19 HD	6'6"/6'9"	THU-21781	THU-43002XT
14-23	Silverado/Sierra 1500	5'8"	THU-21782	THU-43002XT
99-13	Silverado/Sierra 1500 & 07-14 HD	6'6"	THU-21501	THU-43002XT
04-13	Silverado/Sierra 1500 Crew Cab	6'6"	THU-21608	THU-43002XT
DODGE/RAM				
02-23	Ram 1500 & 03-23 2500/3500	6'4"	THU-21501	THU-43003XT
09-23	Ram 1500	5'7"	THU-217860	THU-43003XT
FORD				
99-22	Super Duty	6'9"	THU-21785	THU-43003XT
97-23	F150	6'6"	THU-21501	THU-43002XT
04-23	F150 Super Crew	5'6"	THU-21508	THU-43002XT
TOYOTA				
07-21	Tundra	6'6"	THU-21610	THU-43002XT
07-21	Tundra	5'6"	THU-21611	THU-43002XT

TracRac SR Base Rail Tie Downs



Create additional mounting points anywhere in the truck bed with the sliding powder coated aluminum tie-downs. **THU-25100**

> TracRac® Pro 2

Designed for the professional, this rack system transports cargo and other materials.



1,000 lbs
capacity

when evenly distributed
across both racks
& installed correctly



> TracRac Pro 2 | features

- Protect different size loads with the aluminum load stops that adjust to the full width of the truck
- Rack and cargo remain stable and secure due to corner brace design and aluminum crossbars
- Aerodynamic and quiet due to the integrated wind deflectors
- Securely transport all cargo with the aluminum ARC cleats that provide additional tie-down points
- Easy to install to most truck beds with universal mounting and integrated toolbox mounts
- Durable, corrosion resistant aluminum construction
- System weight: 55 lbs
- **System includes:** Front and rear dual-powder coated aluminum racks, (8) single-axis clamps with integrated toolbox mounts, (2) toolbox mount shims, (4) sliding aluminum crossbar tie-downs, and (4) aluminum ARC side cleats

YEAR	MODEL	BED	PART NO.
CHEVROLET/GMC			
07-23	Silverado/Sierra 1500 & 07-23 HD	8'	THU-37002XT
07-23	Silverado/Sierra 1500 & 07-23 HD	6'6"/6'9"	THU-37002XT
04-23	Silverado/Sierra 1500	5'8"	THU-37002XT
88-06	Silverado/Sierra	8'	THU-37002XT
88-06	Silverado/Sierra	6'6"	THU-37002XT
DODGE/RAM			
02-23	Ram 1500 & 03-23 2500/3500	8'	THU-37002XT
02-23	Ram 1500 & 03-23 2500/3500	6'4"	THU-37002XT
94-01	Ram	8'	THU-37002XT
94-01	Ram	6'6"	THU-37002XT
FORD			
99-22	Super Duty	8'	THU-37003XT
99-22	Super Duty	6'9"	THU-37003XT
97-23	F150	8'	THU-37002XT
97-23	F150	6'6"	THU-37002XT
04-23	F150 Crew Cab	5'6"	THU-37002XT
TOYOTA			
07-21	Tundra	8'	THU-37002XT
07-21	Tundra	6'6"	THU-37002XT
07-21	Tundra	5'6"	THU-37002XT
16-23	Tacoma	6'	THU-37005XT
16-23	Tacoma	5'	THU-37005XT

> TracRac® TracOne

The perfect rack for those occasions when you need to carry ladders, lumber and other materials.



800 lbs
capacity

when evenly distributed
across both racks
& installed correctly

> TracRac® TracOne | features

- Protect different size loads with the aluminum load stops that adjust to the full width of the truck
- Aerodynamic and quiet due to the integrated wind deflectors
- Easy to install with drill-free mounting
- Durable, corrosion resistant aluminum construction
- System weight: 50 lbs
- **System includes:** Front and rear dual-powder coated aluminum racks, (8) single-axis clamps, (2) toolbox mount shims, (4) aluminum crossbar tie-downs



THU-27000XT - Silver
THU-27000XTB - Black

will not fit Ford Super Duty



> TracOne Fit Kits

compact/fullsize truck toolbox mount kit | THU-41000
16-23 Tacoma requires special mount kit | THU-34001
05-15 Tacoma requires special mount kit | THU-34000

> TracRac® Cap

A lightweight and easy to install, aerodynamic rack designed specifically to increase the carrying capacity of your cap.

500 lbs
capacity

when evenly distributed
across both racks
& installed correctly

> TracRac® Cap | features

- Aerodynamic and quiet due to the integrated wind deflectors
- Protect different size loads with the aluminum load stops that adjust to the full width of the cap
- Adapts to curved surfaces for easy installation with the Swivel Adapter Bracket
- System weight: 25 lbs
- **System includes:** (2) dual-powder coated aluminum racks, (4) aluminum crossbar tie-downs

THU-29200XT





> Xsporter Pro™ Mid

The perfect mid-sized rack for those occasions when you need to carry a rooftop tent, basket, or other equipment.

- Wind Diffuser technology disturbs airflow to reduce noise and drag for improved fuel economy
- Easily mount the Thule Accessory Side Bar for additional gear hauling capacity (sold separately)
- Ideal rack height (16") allows for easy truck bed access and sits below cab of truck for improved aerodynamics
- Versatile design fits most compact and full-size pickup trucks



600 lbs capacity
when evenly distributed across both racks & installed correctly

THU-500011 - Black

> Xsporter Pro™ Shift

This truck rack easily moves into any position to accommodate different size loads and works with tonneau covers.

- Wind Diffuser technology disturbs airflow to reduce noise and drag for improved fuel economy
- Easily mount the Thule Accessory Side Bar for additional gear hauling capacity (sold separately)
- Ideal rack height (18") allows for easy truck bed access and sits below cab of truck for improved aerodynamics
- Sliding racks adjust to the length of the bed to carry different loads and can easily be removed



600 lbs capacity
when evenly distributed across both racks & installed correctly

Black

YEAR MODEL	BED	BASE RAILS	OVERHEAD RACK	YEAR MODEL	BED	BASE RAILS	OVERHEAD RACK
CHEVROLET/GMC							
20-23 Silverado/Sierra HD	6'9"	THU-217870	THU-500010	99-22 Super Duty	6'9"	THU-21785	THU-500010
14-23 Silverado/Sierra 1500 & 15-19 HD	6'6"/6'9"	THU-21781	THU-500010	97-23 F150	6'6"	THU-21501	THU-500010
14-23 Silverado/Sierra 1500	5'8"	THU-21782	THU-500010	04-23 F150 Super Crew	5'6"	THU-21508	THU-500010
99-13 Silverado/Sierra 1500 & 07-14 HD	6'6"	THU-21501	THU-500010	TOYOTA			
04-13 Silverado/Sierra 1500 Crew Cab	6'6"	THU-21608	THU-500010	07-21 Tundra	6'6"	THU-21610	THU-500010
DODGE/RAM							
02-23 Ram 1500 & 03-23 2500/3500	6'4"	THU-21501	THU-500010	07-21 Tundra	5'6"	THU-21611	THU-500010
09-23 Ram 1500	5'7"	THU-217860	THU-500010				

> Xsporter PRO Low™

Bring It All

Designed for full-size and compact pickup trucks, this bed level truck rack is perfect for carrying a rooftop tent, basket and other equipment up to 220lbs.

- Includes two crossbars and four mounting feet
- Made from durable, corrosion-resistant aluminum for years of use
- Includes the Thule OneKey system to lock the truck rack to the truck bed

THU-500012 - Compact Size - Black

THU-500013 - Full Size - Black

Truck rack is at the ideal bed level height to sit below the cab for improved aerodynamics and easier loading/unloading



Universal mounting brackets require no cutting or drilling and work with traditional bed rails and trucks bed-mounted track systems

> Xsporter Pro™

Complete pickup truck bed system with innovative height adjustability and wind tunnel-optimized aerodynamics.

> Xsporter Pro™ | features

- Custom Adjust Bar height provides maximum carrying versatility for easy loading, carrying and storage
- Integrated AirTrip bar technology redirects airflow for superior aerodynamics
- WindDiffuser technology disturbs airflow to reduce noise and drag for improved fuel economy
- Installation requires no cutting or drilling and only limited assembly
- Included tool-free load stops help secure oversized loads
- SecureLock locks the rack to the truck with four One-Key lock cylinders (included)

SILVER
THU-500XT

BLACK
THU-500XTB



450 lbs capacity
when evenly distributed across both racks & installed correctly

> Adapter Kits

16-23 Tacoma | **THU-XK4**
05-15 Tacoma with bed track system | **THU-XK3**

> TracRac® Van ES

Specifically designed for Euro-style vans to increase van carrying capacity.

500 lbs capacity
when evenly distributed across both racks & installed correctly



> TracRac® Van ES | features

- Protect different size loads with the aluminum load stops that adjust to the full width of the van
- Aerodynamic and quiet due to the integrated wind deflectors
- Easy installation with fixed point mounting
- Durable, corrosion resistant aluminum construction
- System weight: 30 lbs
- System includes: Front and rear powder coated aluminum load bars, (4) steel reinforced feet, (4) crossbar load stops, and (1) vehicle-specific hardware kit

YEAR	MODEL	WIDTH	PART NO.
15-23	Chevrolet City Express	53"	THU-29614XT
14-23	Ford Transit	69"	THU-29610XT
14-23	Ford Transit Connect	53"	THU-29611XT
10-17	Mercedes-Benz Sprinter w/ fixed points	69"	THU-29612XT
13-23	Nissan NV200	53"	THU-29614XT
14-23	Ram ProMaster	69"	THU-29613XT
14-23	Ram ProMaster City	69"	THU-29616XT



> TracRac® Van 2 Bar

- Protect different size loads with the aluminum load stops that adjust to the full width of the van
- Aerodynamic and quiet due to the integrated wind deflectors
- Easily installs to the rain gutters for quick installation
- Durable, corrosion resistant aluminum construction

THU-29055XT

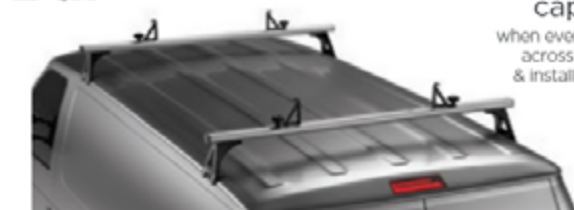

500 lbs capacity
when evenly distributed across both racks & installed correctly

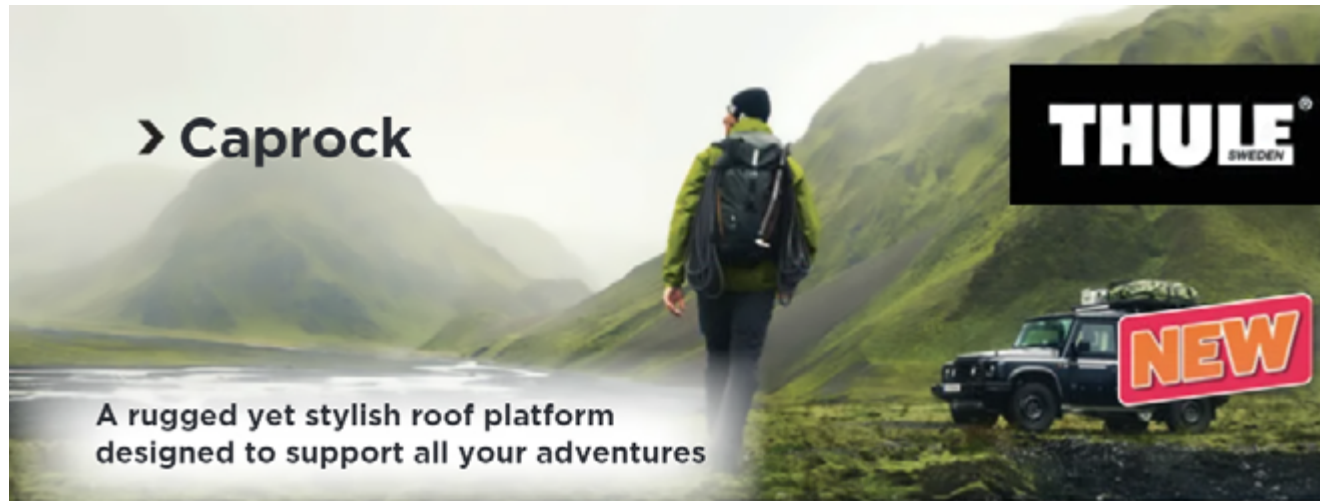

A rugged yet stylish roof platform designed to support all your adventures

Transform the roof of your vehicle into the foundation for adventure with the Thule Caprock roof platform. With its modular design and endless possibilities for attaching a rooftop tent or accessories, this sleek roof platform will support all your gear and mounts to a host of vehicle types, with or without crossbars.



HEAVY LOAD CAPACITY
Heavy-duty roof platform rack that lets your vehicle carry bulky cargo with ease. The platform is designed to fit common roof rack systems and provides several mounting options with integrated T-slots.

VERSATILE DESIGN
Mount various Thule rack products, a rooftop tent or accessories for overlanding, camping, and more into the integrated track system and base crossbars.

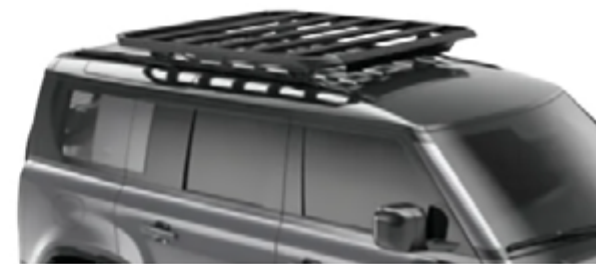
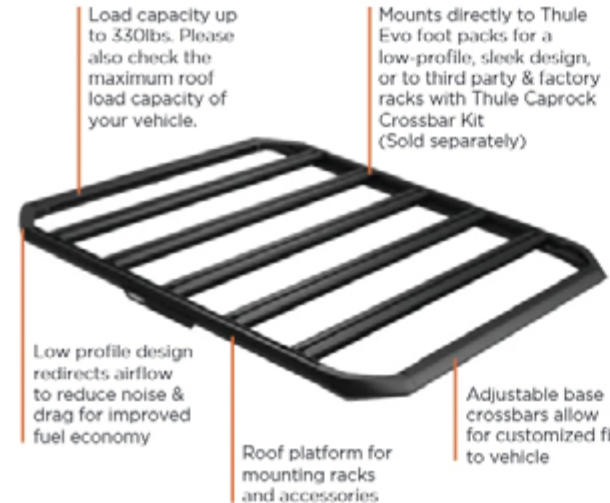

CAPROCK SIZE CHART

THU-611001	Caprock S - 52" x 59" - 51 lbs
THU-611002	Caprock M - 59" x 59" - 57 lbs
THU-611003	Caprock L - 59" x 75" - 54 lbs
THU-611004	Caprock XL - 65" x 59" - 57 lbs
THU-611005	Caprock TB - 65" x 83" - 77 lbs
THU-611006	Caprock XXL - 75" x 75" - 63 lbs

GO RHINO XRS XTREME RACK SYSTEM

THE FOUNDATION OF THE XRS SYSTEM IS THE XTREME RACK, WHICH HAS A CONTOURED, APPLICATION-SPECIFIC FIT, AND FEATURES GO RHINO'S EXCLUSIVE 4-CORE CROSSBAR SYSTEM.



- A** Equipped with Go Rhino's exclusive 4-CORE cross bars, the extruded track system that works with any 1/4"x20 hex bolt, is Quick Fist®-compatible and provides unlimited accessory mounting options for gear and trail tools
- B** Compatible with most rooftop tents - 300 lb. dynamic and 600 lb. static weight rating
- C** Constructed with a combination of steel and aluminum for an optimum balance of strength and weight savings
- D** 2" diameter front and rear aluminum crossbars tie the rack together
- E** Uprights feature integrated MOLLE pattern holes, 1/4"-20 threaded inserts at top and bottom, rear mounting holes for handles or other accessories and welded rods for additional tie downs
- F** Includes one Rhino Accessory Gear Plate that can be attached on top, sides or interior. Additional plates can be purchased (GOR-5950020T See next page).
- G** No drill, complete bolt-on installation. Available with factory bed track mounting systems or bed rail clamp on mounting brackets. Mounting brackets have built-in tie down points
- H** Wide variety of Go Rhino accessories available

5 YEAR WARRANTY
ON TEXTURED POWDER COAT FINISH
LIFETIME STRUCTURAL WARRANTY



YEAR	MODEL	PART NO.
CHEVROLET/GMC		
19-23	Silverado	GOR-5952000T
15-22	Colorado/Canyon	GOR-5951000T
FORD		
21-23	F150	GOR-5952000T
19-23	Ranger	GOR-5951000T
JEEP		
20-23	Gladiator	GOR-5950000T
RAM		
19-23	Ram 1500	GOR-5952000T
TOYOTA		
14-21	Tundra	GOR-5952000T
16-23	Tacoma	GOR-5951000T



4 CORE CHANNEL TECHNOLOGY

XRS Xtreme Rack & 4-Core Accessories on Next Page



GO RHINO XRS XTREME RACK SYSTEM

4-CORE ACCESSORIES

The 4-CORE Difference

SRM Racks | CEROS Racks | XRS Overland Series

EXCLUSIVE 4-CORE CROSSRAIL SYSTEM PROVIDES UNLIMITED ACCESSORY MOUNTING OPTIONS



Slotted rails on both sides of bar increases mountable surface area on the XRS Xtreme Rack - accessories can be mounted on top, sides, inside or outside

Wide variety of Go Rhino accessories available slots that accept 1/4-20 hex bolts

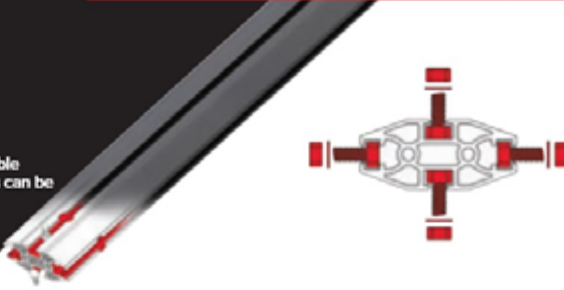

XRS ACCESSORY GEAR TABLE

THE GO RHINO GEAR TABLE IS AN XTREME RACK (XRS) ACCESSORY THAT PROVIDES AN OUTDOOR WORK SURFACE WHILE DOUBLING YOUR STORAGE SPACE

- A** WHEN OPEN: Table surface is lightweight, sanitary and easy to clean
- B** INTERIOR STORAGE: Inside space allows for accessories up to three inches deep (such as shovels and axes) when strapped to rack
- C** WHEN CLOSED: Mounting points on outside provides additional storage space for a variety of items, such as Max Trax, Tread Pro traction boards, Daystar cans, Jerry Cans, etc. (Accessories not included)



- Attaches to either side of the Xtreme Rack
- Engineered to safely keep table level - Table has 200lb weight capacity to hold plenty of gear and tools
- Accommodations for a padlock for extra security



GOR-5950110T

RHINO ACCESSORY GEAR PLATE



- Countless combinations that provides the real estate needed for your accessories
- Easily bolts on to 4-CORE 10-inch spaced crossbars of the SRM, CEROS and XRS Series products
- Universal application: can be mounted on any flat surface
- Specially designed to mount a variety of accessories from major manufacturers: Roto Pax, MOLLE/PALS, Max Trax

GOR-5950020T

XRS REEL HANDLE KIT



- Bolts to front, rear or both front and rear of Xtreme Rack with easy, no-drill installation
- Universal application: Flat mounting surface makes it a fit for many applications, including marine
- Fabricated tubular steel and black texture powder coat

GOR-5950100T (Pair)

XRS TO SRM CONNECTOR



- Mounts the SRM600, SRM500 or SRM400 Roof Rack to the top of the Xtreme Rack

GOR-5950010T (set of 4)

XRS CAB OVERHANG MOUNT KIT

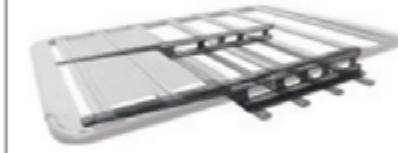

Need more loading space? Add any SRM basket to your existing XRS Rack with our cab overhang bracket. Works with any 55", 65", or 75" basket. Allows you to use a larger roof top tent or carry larger accessories.

- MOUNT KIT FOR 55" BASKET GOR-5950055T
- MOUNT KIT FOR 65" BASKET GOR-5950065T
- MOUNT KIT FOR 75" BASKET GOR-5950075T

RHINO QUICK RELEASE ROOFTOP TENT BRACKET KIT



- Designed to work with 4-CORE slotted cross rails on XRS Xtreme Rack or SRM500 Platform Roof Rack
- Easy, pull pin release allows you to avoid annoying tent straps or tie downs

GOR-5950030T (set of 4)

RHINO AWNING BRACKET KIT



- Mounts awning to SRM, CEROS or XRS Series
- Specially designed to curve around the XRS Rack's end caps and under the tent
- Multiple awning options: slots for standard awnings, "bat wing" style large awnings, & custom configurations

GOR-5950040T (Pair)

4-CORE RHINO TIE DOWNS

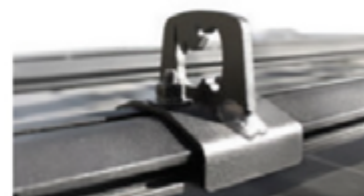

- Handy accessory for ropes, tie downs or bungee cords
- Fits anywhere on any 4-CORE system (SRM, CEROS or XRS) and future 4-CORE applications

GOR-5950130T (set of 4)

4-CORE FLOOR PLATE INSERT KIT (4 PIECE)



- Designed to work with 4-CORE slotted cross rails on SRM, XRS Xtreme, and CEROS roof rack systems
- Precision cut steel inserts come in textured black powder coat
- Can be configured vertically or horizontally
- Punched holes work with most traction boards & Roto Pax systems

GOR-5950090T (set of 4)

4-CORE MOUNT KIT FOR HI-LIFT JACK



- Hi-Lift Jack Mount Bracket provides a safe, quiet, and secure mounting point for a Hi-Lift Jack, on your SRM rack or XRS rack
- Maximize space and allows you to use most of your bed space on XRS Bed Racks

GOR-5950060T (Pair)

4-CORE MOUNT KIT FOR FOLDING TABLE



- Maximize space and safely secure your folding table
- Compatible with most 6" folding tables
- Allows you to use most of your bed space underneath your XRS rack

GOR-5950050T (set of 4)

GO RHINO XRS CROSS BARS

NEW



Optional Side Rail Accessory Kit 37-3/4" or 49-1/2"

5 YEAR WARRANTY
ON TEXTURED POWDER COAT FINISH
LIFETIME STRUCTURAL WARRANTY

- Unlimited accessory mounting options for gear and trail tools with Go Rhino's exclusive 4-CORE aluminum cross bars; 4-CORE is an extruded track system that works with any 1/4x20 hex bolt
- Truck bed rack system includes four 6" tall uprights, two cross bars and mounting hardware, providing clearance for unobstructed use of truck bed
- Compatible with Go Rhino's SRM Series of Roof Racks such as the SRM400, SRM500 and SRM600 racks, and with most of Go Rhino's 4-CORE accessories
- 600 lbs. static or 300 lbs. dynamic maximum weight, evenly distributed - Always check Vehicle Owner's Manual for each vehicle's weight recommendation
- Durable, textured black powder coat finish for long life
- Industry-leading 5-year limited warranty



4-CORE CROSS BARS



MULTI-USE UPRIGHTS



WORKS WITH FACTORY RAILS



OPTIONAL ACCESSORY

DESCRIPTION	PART NO.	DESCRIPTION	PART NO.
XRS CROSS BARS		OPTIONAL ACCESSORIES	
Mid-Sized Truck Beds	GOR-5935000T	Side Rail Accessory Kit - 37 3/4"	GOR-5935010T
Full-Sized Truck Beds	GOR-5935001T	Side Rail Accessory Kit - 49 1/2"	GOR-5935011T

CEROS LOW PROFILE ROOF RACK

NEW



5 YEAR WARRANTY
ON TEXTURED POWDER COAT FINISH
LIFETIME STRUCTURAL WARRANTY

- Low profile aluminum construction for a sleek, aerodynamic look that will last the life of your vehicle
- Equipped with Go Rhino's exclusive 4-CORE cross bars, the extruded track system that works with any 1/4x20 hex bolt, is Quick Fist®-compatible and provides unlimited accessory mounting options for gear and trail tools
- Front 4-CORE rail supports front fairing and mounts individual lights and light bars easily and securely
- Four side panel slots with removable mesh screens fit most 6-inch single row (SR) lights, mounting brackets included
- Full front fairing with dropped front edge allows most single row LED light bars to remain flush with frame
- No drilling required, all steel mounting hardware included
- Vehicle specific applications for a perfect fit for a no-drill install or clamp on install

Max weight: 150 lbs evenly distributed, including rack
Overall dimensions: 62" long, 47" wide
Textured black powder coat finish - 5 Year Warranty



4-CORE CROSS BARS



AERODYNAMIC STYLE



LIGHT-READY SIDE PANELS



DROPPED EDGE FOR LIGHT BAR

YEAR	MODEL	PART NO.	YEAR	MODEL	PART NO.
CHEVROLET/GMC			TOYOTA		
19-23	Silverado/Sierra 1500	GOR-5933110T	16-21	Tundra	GOR-5933120T
DODGE/RAM			10-23	Tacoma	GOR-5933000T
19-23	Ram 1500	GOR-5933130T	10-23	4Runner	GOR-5933001T
FORD					
21-23	F150	GOR-5933140T			

GORRHINO

SRM 400 RACK



SRM400 Modular Roof Rack

Go Rhino's new series of roof racks allows a whole new level of customization with removable front and rear fairings. Removing the fairing allows for the installation of front or rear facing lights. Optional side mounts for dualy lights included. Fairing removed, longer items like paddleboards and kayaks can be carried as well. Slotted cross bars create easy mount for accessories.

SRM400 RACK

FEATURES

- Galvanized steel fabricated panels
- Extruded aluminum cross bars
- Injection molded Nylon cross bar end caps attach the cross bars securely to the fabricated side panels
- Integrated side light mounts for standard cube stem mount LED lights
- Integrated hole pattern for standard scene light mounts - two sets per side
- Solid front fairing reduces wind noise while vented rear cover allows for air to escape reducing noise from turbulence
- Front fairing and rear cover are removable exposing multiple mounting hole patterns for a variety of lighting styles
- Universal U bolt style mounting clamp system included



SRM U-CLAMPS Included



LENGTH	SRM400 RACK
48"	GOR-5934048T
58"	GOR-5934058T
68"	GOR-5934068T

PUTCO OVERLAND RACKS
VENTURE TEC

PUTCO's VentureTEC Overland Modular Cargo System begins with a sleek bed rack designed to provide endless mounting options through its patent-pending TEC channel system. Constructed using high quality, lightweight 6061 t6 aluminum, this cargo system allows you to bring anything on-the-go!



FEATURES

- **EZ-TEC ACCESS SLOTS** Easily place or remove TEC channel compatible products for customizing your cargo load
- **CLAW-GRIP JOINTS** Every joint is securely fastened with a 4-bolt mechanism paired with the CoreTEC Block which is a solid aluminum stabilization insert.
- **STAKE POCKET BED MOUNTS** The core of the system mounts to any truck bed via stake pocket mounts which allows the truck bed to be a strong foundation for the rack.
- **TIE DOWN POINTS** Tie down points have been integrated in the VentureTEC design for the convenience of securing cargo
- **CNC 7 AXIS BENDING** CNC 7 axis bending allows for exact vehicle cab contour to create a sleek look to your vehicle while maintaining full functionality of the rack

TARGET FEATURE

VentureTEC TUBE DESIGN + CoreTEC BLOCK



- A TEC CHANNEL SYSTEM**
Designed as a universal system for all VentureTEC accessories to fasten securely to the rack.
- B CUSTOM BLADE GROOVE**
This custom groove is fully compatible with any Putco patented Blade LED Light Bar.



100% MADE IN THE USA

** See next page for applications

PUTCO OVERLAND RACKS

VENTURE TEC

APPLICATIONS

YEAR	MODEL	PART NO.	YEAR	MODEL	PART NO.
CHEVROLET/GMC			FORD (cont)		
20-23	Silverado/Sierra HD 6'9"	PUT-184020	15-23	F150 6'6"	PUT-184110
14-23	Silverado/Sierra 1500 5'8"	PUT-184000	JEEP		
14-23	Silverado/Sierra 1500 6'6"	PUT-184010	20-23	Gladiator 5'	PUT-184500 ¹
DODGE/RAM			TOYOTA		
19-23	Ram 1500 5'7"	PUT-184300	14-21	Tundra 5'6"	PUT-184600
19-23	Ram 1500 6'4"	PUT-184310	14-21	Tundra 6'6"	PUT-184610
FORD			16-23	Tacoma 5'	PUT-184400
17-22	Super Duty 6'9"	PUT-184200	16-23	Tacoma 6'	PUT-184410
15-23	F150 5'6"	PUT-184100	Footnote: 1. This rack is designed to interface with the in-bed rail system equipped on Rubicon trim level Gladiators. To use this system with other trim levels, you will need to purchase Putco's Gladiator Sport Mounting Kit PUT-184560		

RACK ACCESSORIES



GRAB HANDLES

These aluminum die cast handles fasten anywhere on the VentureTEC rack to provide a sturdy grip for holding on to.



TEC TABLE

These arms clamp to the frame of the VentureTEC rack and create a support unit to hold a platform that can be used as a work space or table.



MINI TIE DOWNS

Tie downs fasten to VentureTEC system to provide secure tie down points nearly anywhere on the rack. Item sold as a pair.



MOUNTING PLATE

Made from black-coated stainless steel. Made to attach to the side of the VentureTEC rack and is fully compatible with Rotopax mounting system.



FULL LENGTH MOUNTING PLATE

Full-length version of the TEC grate made from black-coated aluminum with all the same functionality and more.

ACCESSORIES

DESCRIPTION	PART NO.	DESCRIPTION	PART NO.
ACCESSORIES		MOUNTING PLATES	
VentureTec Grab Handles	PUT-185700	VentureTec Mounting Plate 11"x 17"x 18"	
VentureTec Tec Table w/ Mounting Arms	PUT-185707	- 17-22 Super Duty, 20-23 Gladiator	PUT-185705
VentureTec Tec Mini Tie Downs - 500LB	PUT-185708	VentureTec Mounting Plate 11"x 17"x 50"	
VentureTec Luminix Tec Mount	PUT-185710	- 20-23 Gladiator Full Length	PUT-185706
MOUNTING PLATES		VentureTec Mounting Plate 11"x 17"x 65"	
VentureTec Mounting Plate 12"x 12.5"x 18"	PUT-185703	- 17-22 Super Duty Full Length	PUT-185709
VentureTec Mounting Plate 12"x 12.5"x 54"	PUT-185704	VentureTec Mounting Plate 12.4"x 17.3"x 18"	
		- 17-22 Super Duty	PUT-185712

PUTCO ELEVATED TEC CROSSRAIL

VENTURE TEC

KICK IT UP A NOTCH WITH ELEVATED TEC CROSS RAILS

This version of the TEC Crossrail takes your Venture TEC Rack or your Truck Bed TEC Rails to the next level. This allows you to maximize the cargo space of your truck and provides more areas to add more items or storage to your rack or rail set. Putco's patented TEC Channels are featured on the crossrails and continues the endless ways that you can customize your Venture TEC Rack or TEC Rails.



ELEVATED TEC CROSSRAILS

CoreTEC CONNECTOR BLOCK

The Core TEC Connector Block is a solid billet aluminum insert that fits snugly within the tube end and reinforces each joint section to ensure stability and strength of the structure.

ELEVATED TEC CROSSRAIL FEATURES

- 6061 T6 Aluminum construction
- 9" aluminum risers
- CoreTEC Connector Block reinforces end joints
- Sized to specific Venture TEC Rack or TEC Rail (sold separately)

ELEVATED TEC CROSSRAILS APPLICATIONS

YEAR	MODEL	PART NO.
CHEVROLET/GMC		
20-23	Silverado/Sierra HD	PUT-185731
14-23	Silverado/Sierra 1500	PUT-185731
15-23	Colorado/Canyon	PUT-185734
DODGE/RAM		
20-23	Ram 2500/3500	PUT-185733
19-23	Ram 1500	PUT-185733
FORD		
17-22	Super Duty	PUT-185731
15-20	F150	PUT-185732
15-23	Ranger	PUT-185734
JEEP		
20-23	Gladiator	PUT-185735
TOYOTA		
14-21	Tundra	PUT-185732
16-23	Tacoma 5'	PUT-185734



Elevated Tec Crossrails shown on Venture TEC Rack. See page 386 for Venture TEC Rack applications.



Elevated Tec Crossrails shown on TEC Rails. See page 386 for Venture TEC Rack applications.

ELEVATED TEC CROSSRAILS

Elevated Tec Crossrails are perfect for hauling larger or longer cargo by safely securing items above your truck's cab area.

- Patented TEC Channel System for attaching accessories
- Installs in minutes
- Sold as pair

WESTIN

OVERLAND CARGO RACK



- Low profile design keeps cargo gear below cab roof line
- Constructed of 14 gauge for strength and durability
- Multi-purpose "cargo management system" allows variety of gear storage
- Unique design utilizes OEM bed rails for easy installation
- Engineered for most roof top tents
- Top support rails can be mounted in multiple positions
- Custom die-cast riveted logo badge
- Hardware and mounting brackets included
- E-coated base coat provides long lasting corrosion protection
- Texture black powder coat finish
- Bolt-on installation - no drilling required

Weight Capacity Rating:

- Non-Moving 800 lbs
- On Road Moving 400 lbs
- Off Road Moving 250 lbs

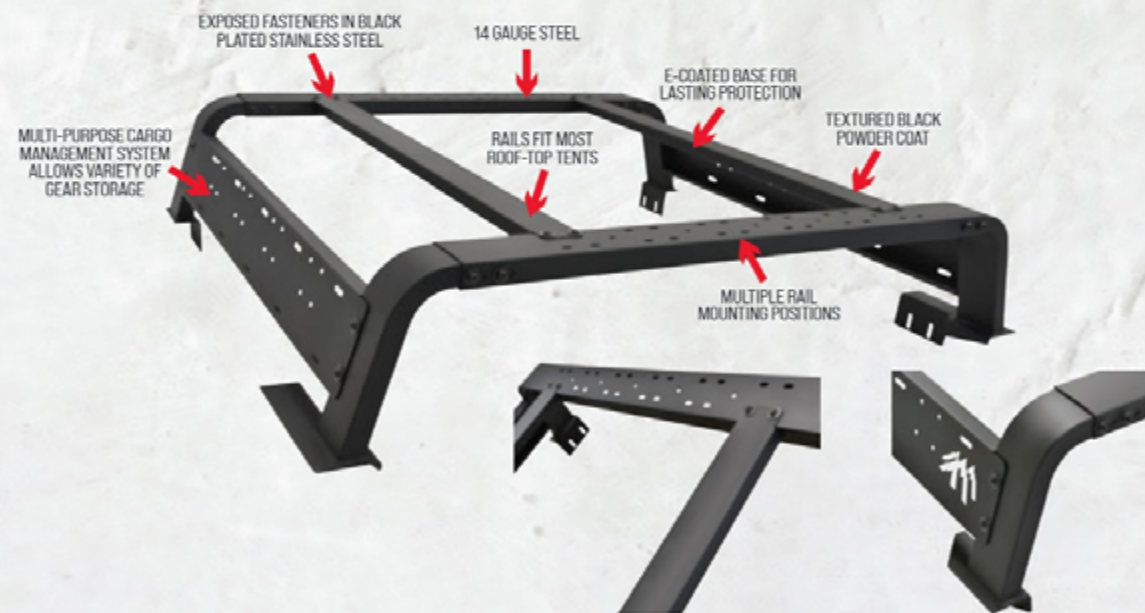

YEAR	MODEL	PART NO.
JEEP		
20-23	Jeep Gladiator	WES-51-10005 ^{1,2}
TOYOTA		
05-23	Toyota Tacoma 5'	WES-51-10015 ^{1,2}
05-23	Toyota Tacoma 6'	WES-51-10025 ^{1,2}

FOOTNOTES: 1. Prohibits use of tonneau covers
2. Requires use of OEM Bed Rail Kit
3. Requires use of OEM Trail Rail System

ROTO PAX

Fuel Containers

RotoPAX-Gas Packs are rotationally molded for superior strength and a leak-proof design that puts to shame traditional blow-molded carriers. RotoPAX-have solid thick walls and extra threads with a sure-seal gasket, guaranteeing it will not leak or vibrate loose. The rotational molded design strengthens construction and is made from colorfast materials, so they're less prone to fading or wearing out. The RotoPAX-packs feel solid, like you could run them over with a truck, and they wouldn't leak a drop. All RotoPAX-gas containers are molded using our patented three layer design. This state of the art molding technique exceeds the EPA requirements. RotoPAX-Gas Containers are offered in various sizes depending on your needs. Remember to vent the PAX-regularly.

GASOLINE RED	
1 Gallon	PAX-RX-1G
1.75 Gallon	PAX-RX-1.75G
2 Gallon	PAX-RX-2G
3 Gallon	PAX-RX-3G
4 Gallon	PAX-RX-4G
DIESEL YELLOW	
2 Gallon	PAX-RX-2D
WATER WHITE	
1 Gallon	PAX-RX-1W
1.75 Gallon	PAX-RX-1.75W
2 Gallon	PAX-RX-2W
STORAGE BLACK	
2 Gallon (empty)	PAX-RX-0S



ROLLPAX

RollPAX-is an ideal solution for carrying extra fuel or water on any roll bar or flat surface. With a 1.5 Gallon capacity, RollPAX-will give you enough fuel and water to keep the adventure going for that much longer.

APPLICATION	WATER CONTAINERS	FUEL CONTAINERS	HARDWARE ONLY
1.75" Tube	PAX-RPX-1.5W-1.75IN	PAX-RPX-1.5G-1.75IN	PAX-RPX-1.75IN
2" Tube	PAX-RPX-1.5W-2IN	PAX-RPX-1.5G-2IN	PAX-RPX-2IN
Flat Surface	PAX-RPX-1.5W-FB	PAX-RPX-1.5G-FB	PAX-RPX-FB
Container ONLY	PAX-RPX-1.5W-NH	PAX-RPX-1.5G-NH	-



FUEL PAX

Have you ever been out and needed extra fuel? Are your current fuel cans leaking? It doesn't matter what you have. Jeep, Nissan, Yamaha, side by side, ATV, UTV, snow sled, motorcycle, trailer, Honda, Polaris, RZR... No matter what you drive, and if it needs fuel - FuelPAX-should be the first fuel pack you think of.

FuelPAX-is stackable just like RotopaX. To stack the 1.5 or 2.5, use the RotoPAX-1.75 Extension (PAX-RX-1.75EXT); to stack the 3.5 and 4.5, use the 3 Gallon Extension (PAX-RX-3EXT).

FUEL PAX-CONTAINERS		FUEL PAX-HARDWARE	
2.5 Gallon Gasoline	PAX-FX-2.5	FuelPAX-Pack Mount	PAX-FX-DLX-PM
3.5 Gallon Gasoline	PAX-FX-3.5	FuelPAX-Universal Plate	PAX-FX-UP
4.5 Gallon Gasoline	PAX-FX-4.5	FuelPAX-PAX-JK Tailgate	PAX-FX-JTM
		PAX-Bar Mount	PAX-FX-RMB

FuelPAX-hardware is also compatible with RotopaX.



ROTO X PAX™

Mounting Hardware & Accessories

RotoPAX-containers are designed to be mounted on any flat surface. This can be achieved in several ways: Many customers prefer to design and fabricate their mounting brackets. This option is best for custom applications and aftermarket setups. The other option is to purchase a RotoPAX-bracket. We have various mounting brackets for most applications. All of the Pack Mounts and Mounting Plates are sold separately.

The ingenious PAX-mount design enables you to use any PAX-mount with any of our containers. The PAX-mounts are all made of hardened anodized aluminum and B7 all thread for maximum strength.

(Note: Be sure to not overtighten the PAX-mount. There is no need to crush the container - just tighten the mount until the container is snug.)

STANDARD PACK MOUNT PAX-RX-PM	LOCKING PACK MOUNT PAX-RX-LOX-PM	DELUXE PACK MOUNT PAX-RX-DLX-PM	EXTENSIONS 1, 2, 2.25, & 4 Gal. Extension PAX-RX-EXT 1.75 Gal. Extension PAX-RX-1.75EXT 3 Gal. Extension PAX-RX-3EXT	
STANDARD T-HANDLE PAX-RX-STD-T	LOCKING T-HANDLE PAX-RX-LOX-T	DELUXE T-HANDLE PAX-RX-DLX-T	UNIVERSAL PLATE PAX-RX-UP	SINGLE MOUNT PLATE PAX-RX-SMP
JEEP TIRE MOUNT PAX-RX-TM	TOYOTA/NISSAN MOUNT PAX-RX-TN	POLARIS RZR PLATE PAX-RX-RZR	L-BRACKET PAX-RX-LB	BACKING PLATE PAX-RX-BP
SELF VENTING SPOUT PAX-RX-SP-V	ECO SPOUT PAX-RX-SP-E	CONVENTIONAL SPOUT PAX-RX-SP-C	1.5" EAGLE SPOUT PAX-RX-1.5-E	1.75" EAGLE SPOUT PAX-RX-1.75-E

SNOWMOBILE PLATES

Arctic Cat 2012	PAX-RX-AC
Arctic Short Seat	PAX-RX-ACS
RX-ACL	PAX-RX-ACL
Polaris Plate	PAX-RX-PS
Skidoo Plate	PAX-RX-SD

