

# ULTRACAR



**AU SERVICE  
DES CONCESSIONNAIRES  
TEXTO INFO: 514-592-0005**

## SUSPENSION

depuis 1982  
2023  
514.592.0005



Suivez-nous *Instagram*  
**ultracar.1982**

## ROUES POWDERCOAT NOIR LUSTRÉ GLOSS BLACK POWDERCOAT WHEELS



SERVICE  
**4**  
JOURS  
DAYS

GARANTIE  
**10**  
ANS

**Cueillette et livraison  
gratuites disponibles  
Free pickup & delivery  
available**

**\$149**  
CHAQUE

DAN  
**(514) 592-0005**





**LEVELING SUSPENSION**

MAINTAIN FACTORY RIDE QUALITY • INSTALLATION TIME APPROXIMATELY 1 HOUR



- Fastest, least expensive way to lift and level your truck.
- Great for heavy-duty winch/bumper combos, snowplows or the other parts that weigh down the front end of your truck.
- Underground parking lot safe.

**LIFETIME GUARANTEE**

**CADILLAC / CHEVROLET / GMC**

**FRONT LIFT KIT**

ULT66-3071

Maximum tire diameter: 265/65-17.



15-22 Colorado / Canyon

2/4WD

LIFT 1.25"

**FRONT LOWER STRUT SPACER**

ULT66-3920



19-22 Silverado / Sierra 1500 new body

2/4WD

LIFT 2.0"

**FRONT LEVELING KIT**

ULT66-3921



19-22 Silverado / Sierra 1500 new body

4WD

LIFT 1.75"

**FRONT LEVELING KIT**

ULT66-3086



17-18 Silverado / Sierra 1500

2/4WD

LIFT 2.25"

**SST LIFT KIT**

ULT69-3940



19-22 Silverado / Sierra 1500 new body

4WD

LIFT 4" F/3" R

**4.0" STRUT EXTENSION - 3.0" REAR BLOCK-TUBE**

ULT69-3414 use w/factory aluminium and steel oe arms



14-19 Silverado / Sierra 1500 old body

4WD

LIFT 4" F/1.75" R

**REAR SHOCK EXTENSIONS**

ULT67-3809



99-22 Silverado / Sierra 1500, Suburban, Tahoe, Yukon & XL 2/4WD

Designed to be used with factory shocks on 99-12 GM 1500 trucks with 3" or similar rear lift blocks. These new extensions keep the stock shock length and prevent shock "top out" during excessive cycling such as when driving in rough conditions.

**REAR BLOCK KIT**

ULT66-3002



99-19 Silverado / Sierra 1500 old body

2/4WD

LIFT 2.0"

**LEVELING SUSPENSION**



**CADILLAC / CHEVROLET / GMC**

**FRONT LEVELING STRUT EXTENSION**

Allows installation of tires up to 33" in height.



ULT66-3085

07-19 Silverado / Sierra 1500 old body

2/4WD

LIFT 2.25"

**REAR BLOCK KIT**

ULT66-3003

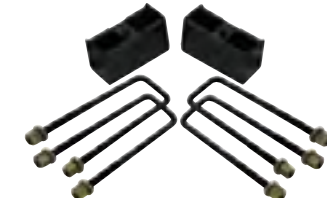

99-19 Silverado / Sierra 1500 old body

2/4WD

LIFT 3.0"

**FORGED TORSION KEY & BRACKET - 8 LUG**

ULT66-3050

Allows installation of tires up to 33" in height.



02-06 Avalanche 2500 4WD  
00-07 Silverado/Sierra 1500HD Classic 2/4WD  
00-10 Silverado/Sierra 2500HD 2/4WD  
00-10 Silverado/Sierra 3500 Dually/Single 2/4WD  
00-10 Suburban/Yukon XL 2500 2/4WD

LIFT 2.5"  
2.5"  
2.5"  
2.5"  
2.5"

**FORGED TORSION KEY - 8 LUG**

ULT66-3020

Allows installation of tires up to 35" in height.



20-22 Silverado / Sierra 2500/3500 HD

2/4WD

LIFT 2"

**REAR BLOCK KIT - 8-LUG**

ULT66-3111

Will not fit vehicle with factory overload springs.



11-22 Silverado / Sierra 2500 HD not Dually

2/4WD

LIFT 1"

**REAR BLOCK KIT - 8-LUG**

ULT66-3112

Will not fit vehicle with factory overload springs.



11-22 Silverado / Sierra 2500 HD not Dually

2/4WD

LIFT 2"

**FRONT LEVELING KIT - HEAVY DUTY FAB CONTROL ARMS**

ULT66-3012



11-19 Silverado / Sierra 2500/3500HD

2/4WD

LIFT 2.25"

**SST LIFT KIT**

ULT69-3512

Allows installation of tires up to 34 in height.



11-19 Silverado / Sierra 2500HD not Dually

2/4WD

LIFT 3.5" F/2" R

**FORGED TORSION KEY - 8 LUG**

ULT66-3011

Allows installation of tires up to 33" in height.



11-19 Silverado / Sierra 2500 HD - 8-Lug

2/4WD

LIFT 2.25"

**REAR BLOCK KIT - 8-LUG**

ULT66-3052

Allows installation of tires up to 33" in height.



88-98 Silverado / Sierra 1500

2/4WD

LIFT 2"

00-10 Silverado / Sierra 2500/3500 not Dually

2/4WD

LIFT 2"

**LEVELING SUSPENSIONS**

**DODGE / RAM**

**SST LIFT KIT**

Max tire  
35x12.50  
on 20x9 +0

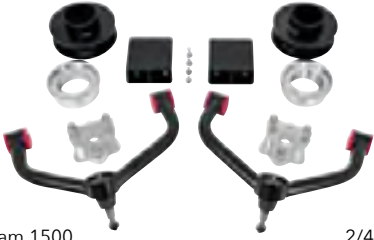

ULT69-1935

**LIFT**

19-22 Ram 1500 2/4WD 3.5" F / 2" R

**FRONT LEVELING KIT WITH TUBULAR UPPER CONTROL ARMS**

Max tire  
285/65-20  
on 20x9 +18



ULT66-19150

**LIFT**

19-22 Ram 1500 (Air Ride Equipped) 4WD 1.5"

**FRONT LEVELING KIT WITH TUBULAR UPPER CONTROL ARMS**

Allows  
installation  
of tires up to  
35" in height.



ULT66-1026

**LIFT**

06-22 Ram 1500 (Air Ride Equipped) 4WD 2.5"

**SST LIFT KIT**

Allows  
installation  
of tires up to  
35" in height.



ULT69-1040

**LIFT**

09-22 Ram 1500 Classic 2/4WD 4" F / 2" R

**SST LIFT KIT**

Allows  
installation  
of tires up to  
35" in height.



ULT69-1031

**LIFT**

09-22 Ram 1500 Classic 2/4WD 1.5"

**STRUT EXTENSION**

Allows  
installation  
of tires up to  
35" in height.



RL66-1030

**LIFT**

06-22 Ram Classic 1500 w/o Factory Air Ride Suspension 4WD 1.5"

**REAR SPACER KIT**



Max tire  
35x12.50  
on 20x9 +0



ULT26-1921

**LIFT**

19-22 Ram 1500 2/4WD 2"

**FRONT LEVELING KIT WITH TUBULAR UPPER CONTROL ARMS**



Max tire  
285/65-20  
on 20x9 +18



ULT66-1921

**LIFT**

19-22 Ram 1500 (Air Ride Equipped) 4WD 2"

**FRONT PRE-LOAD SPACER**

Max tire  
285/65-20  
on 20x9 +18



ULT66-1920

**LIFT**

19-22 Ram 1500 2/4WD 2"

**SST LIFT KIT**



Allows  
installation  
of tires up to  
35" in height.



ULT69-1041

Allows  
installation  
of tires up to  
35" in height.

**LIFT**

09-22 Ram 1500 Classic 2/4WD 4" F / 2" R

**REAR SPACER KIT**



Max tire  
35x12.50  
on 20x9 +0



ULT26-1020

**LIFT**

09-19 Ram 1500 Classic 2/4WD 2"

**LEVELING SUSPENSIONS**

**DODGE / RAM**

**STRUT EXTENSION**

Allows  
installation  
of tires up to  
35" in height.



ULT66-1020

**LIFT**

06-12 Ram 1500 4WD 2.5"

**COIL SPACER**

Allows  
installation  
of tires up to  
35" in height.



ULT66-1090

**LIFT**

94-01 Ram 1500 4WD 2.0"  
94-13 Ram 2500/3500 (NON RADIUS ARM) 4WD 2.0"  
06-09 Ram Mega Cab 4WD 2.0"

**REAR BLOCK KIT**

ULT66-1102



**LIFT**

02-08 Ram 1500 not Mega Cab 2/4WD 2"

**REAR SPACER KIT**



ULT26-1920

**LIFT**

14-22 Ram 2500 not Dually 4WD 2"

**REAR SPACER KIT**



ULT26-1925

**LIFT**

14-22 Ram 2500 not Dually 4WD 2.5"

**REAR SPACER KIT**



ULT26-1935

**LIFT**

14-22 Ram 2500 not Dually 4WD 3.5"

**FRONT LEVELING COIL SPACER**



ULT66-19180

Allows  
installation  
of tires up to  
35" in height.

**LIFT**

19-22 Ram 2500/3500 4WD 1.75"

**SST LIFT KIT**

Allows  
installation  
of tires up to  
37" in height.



ULT69-1930

**LIFT**

19-22 Ram 2500 4WD 3" F / 1" R

**SST LIFT KIT**

Allows  
installation  
of tires up to  
35" in height.



ULT69-1092











**LIFT**

03-13 Ram 2500/3500 4WD 3" F / 2" R



**LEVELING SUSPENSIONS**

**FORD**

<p><b>FRONT LEVELING KIT</b></p> <p><b>N</b></p>  <p><b>ULT66-21100</b></p> <p>21-22 Bronco 4WD</p> <p><b>LIFT</b> 1.25"</p>	<p><b>FRONT LEVELING KIT WITH TUBULAR UPPER CONTROL ARMS</b></p> <p><b>N</b></p>  <p><b>ULT69-21150</b></p> <p>Max tire 245/65-17 on 17x8 +40</p> <p>21-22 Bronco Sport 4WD</p> <p><b>LIFT</b> 1.5"</p>
<p><b>FRONT LEVELING KIT</b></p>  <p><b>ULT66-2120</b></p> <p>21-22 F150 2/4WD</p> <p><b>LIFT</b> 2.0"</p>	<p><b>SST LIFT KIT</b></p> <p><b>N</b></p>  <p><b>ULT69-21350</b></p> <p>21-22 F150 4WD</p> <p><b>LIFT</b> 3.5" F / 1.25" R</p>
<p><b>SST LIFT KIT</b></p> <p>Allows installation of tires up to 35" in height.</p>  <p><b>ULT69-2300</b></p> <p>14-19 F150 2/4WD</p> <p><b>LIFT</b> 3.5" F / 2" R</p>	<p><b>SST LIFT KIT</b></p> <p><b>N</b></p>  <p><b>ULT69-2755</b></p> <p>17-19 F150 Raptor 4WD</p> <p><b>LIFT</b> 2.5"</p>
<p><b>FRONT LEVELING KIT</b></p> <p><b>N</b></p>  <p><b>ULT66-2755</b></p> <p>17-19 F150 Raptor 4WD</p> <p><b>LIFT</b> 2.5"</p>	<p><b>STRUT EXTENSION</b></p> <p>Allows installation of tires up to 35" in height.</p>  <p><b>ULT66-2215</b></p> <p>15-19 F150 2/4WD</p> <p><b>LIFT</b> 2.25"</p>
<p><b>REAR BLOCK KIT</b></p> <p><b>ULT66-2051</b></p>  <p>04-19 F150 2WD</p> <p><b>LIFT</b> 1.5"</p>	<p><b>REAR BLOCK KIT</b></p> <p><b>ULT66-2053</b></p>  <p>04-19 F150 4WD</p> <p><b>LIFT</b> 3"</p>

**LEVELING SUSPENSIONS**

**FORD**

<p><b>STRUT EXTENSION</b></p> <p>Allows installation of tires up to 33" in height.</p>  <p><b>ULT66-2052</b></p> <p>04-14 F150 FX4 2/4WD 03-14 Expedition 2/4WD</p> <p><b>LIFT</b> 1.5"</p>	<p><b>STRUT EXTENSION</b></p> <p>Allows installation of tires up to 35" in height.</p>  <p><b>ULT66-2059</b></p> <p>04-14 F150 FX4 2/4WD</p> <p><b>LIFT</b> 1.5"</p>
<p><b>FRONT LEVELING KIT</b></p> <p>Allows installation of tires up to 35" in height.</p>  <p><b>ULT66-2111</b></p> <p>11-22 F250 Super Duty 4WD</p> <p><b>LIFT</b> 1.5"</p>	<p><b>FRONT LEVELING KIT</b></p> <p>Allows installation of tires up to 35" in height.</p>  <p><b>ULT66-2726</b></p> <p>11-22 F250 / F350 Super Duty 4WD</p> <p><b>LIFT</b> 1.5"</p>
<p><b>SST LIFT KIT</b></p> <p>Allows installation of tires up to 37" in height.</p>  <p><b>ULT69-2735</b></p> <p>17-22 F250/350/450 SD with one-piece drive shaft 4WD</p> <p><b>LIFT</b> 3.5" F / 1-3" R</p>	<p><b>SST LIFT KIT</b></p> <p>Allows installation of tires up to 35" in height.</p>  <p><b>ULT69-2531</b></p> <p>11-16 F250/350/450 SD with two-piece drive shaft 4WD</p> <p><b>LIFT</b> 3.5" F / 1-3" R</p>
<p><b>FRONT LEVELING KIT</b></p> <p>Allows installation of tires up to 37" in height.</p>  <p><b>ULT66-2095</b></p> <p>11-22 F250/350/450/550 4WD</p> <p><b>LIFT</b> 2.5"</p>	<p><b>FRONT LEVELING KIT</b></p> <p>Allows installation of tires up to 35" in height.</p>  <p><b>ULT66-2299</b></p> <p>83-96 Bronco II 2/4WD 81-96 F150 4WD 91-94 Explorer/Navajo 4WD 99-16 F250/F350/F450 SD 2WD</p> <p><b>LIFT</b> 2" 2" 2" 2"</p>
<p><b>FRONT LEVELING KIT</b></p> <p>Allows installation of tires up to 35" in height.</p>  <p><b>ULT66-2726</b></p> <p>19-22 Ranger 4WD</p> <p><b>LIFT</b> 2"</p>	<p><b>FRONT LEVELING KIT</b></p> <p><b>ULT66-2930</b></p>  <p>19-22 Ranger 4WD</p> <p><b>LIFT</b> 3"</p>
<p><b>REAR BLOCK KIT</b></p> <p><b>ULT66-2053</b></p>  <p>19-22 Ranger 4WD</p> <p><b>LIFT</b> 1"</p>	<p><b>FORGED TORSION KEY</b></p> <p>Allows installation of tires up to 32" in height.</p>  <p><b>ULT66-2020</b></p> <p>98-11 Edge 2WD 98-11 Ranger 4WD</p> <p><b>LIFT</b> 2.25" 2.25"</p>



**LEVELING SUSPENSIONS**

**HUMMER**

**FORGED TORSION KEY**

Allows installation of tires up to 33" in height.



ULT66-3050

03-10 H2 - 8-Lug

4WD

**LIFT**  
2.5"

**JEEP**

**SST LIFT KIT**

Allows installation of tires up to 37" in height.



ULT69-6825

18-22 JL Rubicon 2/4 DR

2/4WD 2.5" F/2" R

**LIFT**  
2.5"

**NISSAN**

**SST LIFT KIT**

Allows installation of tires up to 32" in height.



ULT66-4204

05-21 Frontier / XTerra

2/4WD 2.5" F/1.5" R

**LIFT**  
2.5"

**SST LIFT KIT**

Allows installation of tires up to 29.5" in height.



ULT69-4420

14-19 Rogue

2WD

**LIFT**  
2" F/1" R

**FRONT LEVELING KIT**

Allows installation of tires up to 33" in height.



ULT66-4204

04-19 ARMADA/TITAN

2/4WD

**LIFT**  
2"

**FRONT LEVELING KIT**

Allows installation of tires up to 33" in height.



ULT66-4620

16-19 Titan XD

2/4WD 2.5" F/2" R

**LIFT**  
2.5"

**REAR BLOCK KIT**



ULT66-4001

04-19 Titan

2WD

**LIFT**  
1"

**SUBARU**

**SST LIFT KIT**  
Allows installation of tires up to 27.9" in height.



ULT69-9820

18-22 Crosstrek 2WD 2.0" F / 1.5" R

**SST LIFT KIT**  
Allows installation of tires up to 29.5" in height.



ULT69-9020

20-22 Outback 2WD 2.0" F / 2.0" R

**SST LIFT KIT**  
Allows installation of tires up to 29.5" in height.



ULT69-9520

15-19 Outback 2WD 2.0" F / 1.5" R

**LEVELING SUSPENSIONS**

**TOYOTA**

**SST LIFT KIT**

Allows installation of tires up to 32" in height.



ULT66-5055

05-22 Tacoma - 6-Lug

2/4WD

**LIFT**  
2.25"

**REAR BLOCK KIT**

Allows installation of tires up to 29.5" in height.



ULT66-5001

95-22 Tacoma - 6-Lug  
99-21 Tundra All

2/4WD  
2/4WD

**LIFT**  
1"  
1"

**REAR BLOCK KIT**

RL66-5002



95-22 Tacoma - 6-Lug  
99-21 Tundra

2/4WD  
2/4WD

**LIFT**  
2"  
2"

**SST LIFT KIT**

Allows installation of tires up to 32.5" in height.



ULT69-5212

05-22 Tacoma TRD / SR5 / Rock Warrior - 6-Lug 2/4WD

3" F/2" R

**LIFT**  
3"

**FRONT LEVELING KIT**

Allows installation of tires up to 33" in height.



ULT66-5912

05-19 Tacoma/TRD/SR5/Rock Warrior - 6-Lug 2/4WD 2.75"- 3.0"

**LIFT**  
2.75"- 3.0"

**FRONT LEVELING KIT**

Allows installation of tires up to 33-35" in height.



ULT66-5251

07-19 Tundra TRD / SR5 Rock Warrior  
Not for use on 2015-16 Tundra TRD Pro w/ Bilstein shocks

2/4WD  
3"

**LIFT**  
3"

**FRONT LEVELING KIT**

Allows installation of tires up to 33" in height.

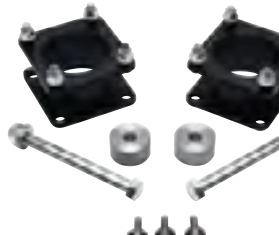

ULT66-5075

07-19 Tundra  
Not for use on 2015-17 Tundra TRD Pro w/ Bilstein shocks

2/4WD

**LIFT**  
2.4"

**SST LIFT KIT**

Allows installation of tires up to 35" in height.



ULT69-5276

07-19 Tundra TRD / SR5 / Rock Warrior  
Not for use on 2015-2019 Tundra TRD Pro w/ Bilstein or Fox TRD Pro shocks

2/4WD  
3" F/2" R

**LIFT**  
3" F/2" R

**SST LIFT KIT**

Allows installation of tires up to 35" in height.



ULT69-5175

07-19 Tacoma/TRD/SR5/Rock Warrior - 6-Lug 2/4WD  
Not for use on 2015-UP Tundra TRD Pro w/ Bilstein or Fox TRD Pro shocks

2/4WD

**LIFT**  
3" F/1" R

**SST LIFT KIT**

Max tire 245/65-17 on 17x8 +38



ULT69-5920

19-22 RAV4  
Will not work with TRD/TRD Pro and Adventure packages

2WD 2" F/1.5" R

**LIFT**  
2" F/1.5" R

**SST LIFT KIT**

Max tire 245/65-17 on 17x8 +38



ULT69-5320

06-18 RAV4  
Not for use on 2015-UP Tundra TRD Pro w/ Bilstein or Fox TRD Pro shocks

4WD

**LIFT**  
2" F/1" R



### TORSION BAR REMOVAL AND INSTALLATION TOOL



**ULT66-7822B**  
2011-UP GM HD trucks and other vehicles that require a large heavy duty tool.



**ULT66-7816A**  
UNIVERSAL  
Not for use with 2011-UP GM HD



### UPPER CONTROL ARMS



**ULT67-1501**  
Ram 1500 4WD 06-18

### TUNDRA TRD PRO SKID PLATE SPACER KIT



**ULT67-5443**  
ReadyLIFT now offers a quality CNC machined aluminum spacer kit designed to lower the TRD Pro Tundra skid plate when the differential is lowered in conjunction with a lift kit. If you have a Tundra (non TRD Pro) and have a TRD PRO skid plate, or want to install one on your lifted truck with a lowered differential, this is the kit you want to get to be able to use the skid plate. Designed to work with our 3" and 4" front lift kits only

### HEAVY DUTY FRONT TRACK BAR

Solves Factory Steering Wobble Issue.



**ULT77-2006**  
Ford Super Duty 4WD 2017-2022 with 0-5 inches of front lift.

### EXHAUST DOWN PIPE EXTENSION



**ULT47-6310**  
JEEP  
JK Wrangler 12-18  
• Stainless steel  
• For use with 2.5" or greater lift systems

### ADD-A-LEAF KIT



**ULT26-2215**  
FORD  
F150 2WD/4WD 04-14  
Inserts into your factory rear spring pack for 1.5" additional lift.

### FRONT DIFFERENTIAL DROP SPACER KITS

Drops differential approximately 1 inch for improved CV angles.



**ULT47-5004**  
TOYOTA  
Tacoma 2005+

### WHEEL SPACERS

Made from 6061-T6 aluminum and precision CNC machined for maximum strength and longevity. These new spacers wheels are designed for use with the ReadyLift 69-3485, 69-3285, 69-3295 and the 69-3495 4" SST Lift Kit when using the stock wheels. Wheel spacers are required when using GM factory wheels and the 4" kit to properly space the factory wheel from the suspension.



**ULT10-3485**  
CHEVROLET / GMC  
Silverado / Sierra 1500 07-18  
7/8" with 14 mm studs



**ULT15-3485**  
CHEVROLET / GMC  
Silverado / Sierra 1500 07-18  
1/2"

### LIFT KITS



#### CHEVROLET / GMC



**ULT35145**

14-19 Silverado / Sierra 1500 old body

FRONT LIFT	REAR LIFT
4.0"	2.0"

Lift kit with upper control arms for aluminum or stamped steel OE upper control arms without shocks



**ULT99104**

15-20 Colorado / Canyon

FRONT LIFT
2.0"



**ULT99101**  
FRONT LIFT KIT

15-19 Colorado / Canyon

FRONT LIFT
2WD/4WD 1.25"



**ULT99107**

19-20 Silverado / Sierra 1500

FRONT LIFT
2WD 3.0"



**ULT99106**  
FRONT LEVELING KIT

19-20 Silverado / Sierra 1500

FRONT LIFT
2WD/4WD 2.0"



**ULT99100**  
STRUT EXTENSION  
6 LUG

07-19 Silverado / Sierra 1500 ('19 old body)

FRONT LIFT
2WD/4WD 2.0"

Allows installation of tires up to 33" in height.



**ULT99004**  
REAR BLOCK KIT

07-19 Silverado / Sierra 1500 ('19 old body)

REAR LIFT
2WD/4WD 2.0"

Allows installation of tires up to 33" in height.



**ULT999003**  
REAR BLOCK KIT

99-19 Silverado / Sierra old body

REAR LIFT
2.0"



**ULT999005**  
REAR BLOCK KIT

99-19 Silverado / Sierra 1500 old body

REAR LIFT
1.0"



LIFT KITS

CHEVROLET / GMC

**ULT35125**

FRONT LIFT	REAR LIFT
3.0"	2.0"

11-17 Silverado / Sierra 2500 HD

**Key way 2.0" rear block and tubular UCA's without shocks**

**ULT9302 FORGED TORSION KEY 8 LUG**

FRONT LIFT
2.25"

11-19 Silverado / Sierra 2500 HD / 3500 HD 2WD/4WD

**Allows installation of tires up to 33" in height.**

**ULT99300 FORGED TORSION KEY 6 LUG**

FRONT LIFT
2.5"

88-07 Avalanche 1500 / Escalade / EXT / ESV 2WD/4WD

88-07 Silverado / Sierra 1500 2WD/4WD

88-07 Tahoe / Suburban / Yukon / Yukon XL 1500 2WD/4WD

**Allows installation of tires up to 32" in height.**

**ULT99301 FORGED TORSION KEY & BRACKET 8 LUG**

FRONT LIFT
2.25"

00-10 Avalanche 2500 2WD/4WD

00-10 Silverado / Sierra 1500HD/2500HD/3500HD 2WD/4WD

00-10 Tahoe 2500 2WD/4WD

00-10 Suburban / Yukon XL 2500 2WD/4WD

**Allows installation of tires up to 33" in height.**

DODGE / RAM

**ULT22104 PRELOAD SPACER**

FRONT LIFT
2.0"

19-20 Ram 1500 4WD

**ULT2519355**

FRONT LIFT	REAR LIFT
3.5"	2.0"

19-20 Ram 1500 4WD

**ULT35405**

FRONT LIFT	REAR LIFT
4.0"	2.0"

2019 Ram 1500 Classic 2WD/4WD

09-18 Ram 1500 2WD/4WD

**ULT22101 STRUT EXTENSION**

FRONT LIFT
2.0"

2019 Ram 1500 Classic 4WD

06-18 Ram 1500 4WD

**Allows installation of tires up to 35" in height.**

LIFT KITS

DODGE / RAM

**RTX22105**

FRONT LIFT
2.0"

2019 Ram 1500 Classic 2WD

09-18 Ram 1500 2WD

**RTX22115 REAR COIL SPACER**

REAR LIFT
1.5"

2019 Ram 1500 Classic 2WD/4WD

09-18 Ram 1500 2WD/4WD

**Allows installation of tires up to 35" in height.**

**RTX22100 STRUT EXTENSION**

FRONT LIFT
2.5"

2019 Ram 1500 Classic 4WD

06-18 Ram 1500 4WD

**Allows installation of tires up to 35" in height. May require rear block/spacer on certain applications**

**RTX22102 COIL SPACER 8-LUG**

FRONT LIFT
2.0"

94-01 Ram 1500 4WD

94-12 Ram 2500/3500 4WD

2013 Ram 2500 4WD

**Allows installation of tires up to 35" in height.**

**RTX35315**

FRONT LIFT	REAR LIFT
3.0"	1.0"

14-19 Ram 2500/3500

**RTX222012 REAR BLOCK KIT**

REAR LIFT
2.0"

03-19 Ram 2500 / 3500 2WD/4WD

**Except dually and top mounted overloads**

FORD

**RTX555001 REAR BLOCK KIT**

REAR LIFT
1.0"

04-20 F150 2WD/4WD



LIFT KITS

FORD

**ULTS106 STRUT EXTENSION**

15-20 F150 2WD/4WD

**FRONT LIFT**  
2.5"

Allows installation of tires up to 35" in height.

**ULTS5100 STRUT EXTENSION**

09-14 F150 2WD  
04-08 F150 not Heritage 4WD

**REAR LIFT**  
3.0"

Allows installation of tires up to 35" in height.

**ULT35005**

14-20 F150 4WD

**FRONT LIFT**  
3.5"

1 piece drive shaft without shocks

**ULT55101 STRUT EXTENSION**

09-14 F150 2WD/4WD  
04-08 F150 not Heritage 2WD/4WD

**FRONT LIFT**  
2.5"

Allows installation of tires up to 35" in height.

**ULT55102 STRUT EXTENSION**

04-14 F150 not Heritage 2WD/4WD

**FRONT LIFT**  
2.0"

Allows installation of tires up to 35" in height.

**ULT35355**

2019 Ram 1500 Classic 2WD/4WD  
09-18 Ram 1500 2WD/4WD

**FRONT LIFT** 4.0"  
**REAR LIFT** 2.0"

Lift kit with 4" tapered blocks for 1 piece drive shaft without shocks

**ULT55107 STRUT EXTENSION**

Allows installation of tires up to 35" in height.

11-18 F250 / F350 / F450 / F550 4WD

**FRONT LIFT**  
2.5"

**ULT55104 STRUT EXTENSION**

05-20 F250 / F350 / F450 / F550 4WD

**FRONT LIFT**  
1.5"

Allows installation of tires up to 35" in height.

LIFT KITS

JEEP

**ULT35265**

18-20 JL Wrangler / Wrangler Unlimited Sahara & Sport 4WD

**FRONT LIFT** 2.5"  
**REAR LIFT** 2.0"

**ULT33102**

07-20 JL Wrangler / Wrangler Unlimited 4WD

**FRONT LIFT** 2.5"  
**REAR LIFT** 2.0"

TOYOTA

**ULT77106 6-LUG**

05-20 Tacoma 2WD/4WD

**FRONT LIFT**  
2.25"

**ULT777001 REAR BLOCK KIT**

95-18 Tacoma 2WD/4WD  
99-20 Tundra 2WD/4WD

**FRONT LIFT**  
1.0"

**ULT777002 REAR BLOCK KIT**

95-18 Tacoma 2WD/4WD  
99-20 Tundra 2WD/4WD

**FRONT LIFT**  
2.0"

**ULT77105**

07-21 Tundra 2WD/4WD

**FRONT LIFT**  
2.50"

**ULT35755**

07-20 Tundra 2WD/4WD

**FRONT LIFT** 4.0"  
**REAR LIFT** 2.0"

With upper control arms without shocks





**POLYURETHANE BODY BUSHING MOUNTS**



FORD			
99-18	F-250	2/4WD	<b>ULTKF04050BK</b>
08-16	F-250	2/4WD	<b>ULTKF04060BK</b>
99-07	F-350	2/4WD	<b>ULTKF04058BK</b>



ULTKF04050BK

ULTKF04058BK & ULTKF04060BK

**LEVELING KITS**



ULTKC09113BK



ULTKC09138BK



ULTKF09101BK



ULTKF09124BK



ULTKF09130BK



ULTKF09150BK



ULTKG09105BK



ULTKG09107



ULTKG09123



ULTKG09129BK



ULTKG09139BK



ULTKG09140BK



ULTKJ09176KV

CHEVROLET / GMC			
14-21	Silverado 1500 - Strut Style	2/4WD 2"	<b>ULTKG09129BK</b>
07-13	Silverado 1500 - Strut Style	2/4WD 2"	<b>ULTKG09105BK</b>
99-10	Sierra 2500/3500 HD, 8 Lug - Torsion Bar	4WD 2"	<b>ULTKG09107</b>
11-19	Sierra 2500/3500 HD, 8 Lug - Torsion Bar	4WD 2"	<b>ULTKG09123</b>
07-21	Sierra 1500	2/4WD 2"	<b>ULTKG09139BK</b>
07-21	Sierra 1500	2/4WD 2"	<b>ULTKG09140BK</b>
FORD			
83-96	Bronco II	2WD 2"	<b>ULTKF09101BK</b>
17-19	F-150 Raptor	4WD 2"	<b>ULTKF09130BK</b>
05-21	F-250/350 Super Duty	4WD 1"	<b>ULTKF09150BK</b>
04-21	F-150	2/4WD 2"	<b>ULTKF09124BK</b>
JEEP			
18-22	JL Wrangler /Gladiator - Kevlar-infused	2/4WD 1.5"	<b>ULTKJ09176KV</b>
RAM			
09-20	1500	4WD 2.5"	<b>ULTKC09113BK</b>
13-21	2500/3500 - Incl 2 Scorpion Shocks	2WD 2"	<b>ULTKC09138BK</b>



**LIFT KITS**



ULTKC09114BK



ULTKC09116BK



ULTKC09139BK



ULTKC09140BK



ULTKF09053



ULTKF09122BK



ULTKG09118BK & ULTKG09138BK



ULTKJ09172BK

FORD			
09-20	F-150	2/4WD 2"	<b>ULTKF09122BK</b>
05-19	F-250 SD Dana 60 w/3-1/2" O.D.	4WD 2.5"	<b>ULTKF09053</b>
CHEVROLET / GMC			
07-13	Silverado 1500	2/4WD 2"	<b>ULTKG09118BK</b>
14-19	Silverado 1500 Classic	2/4WD 2"	<b>ULTKG09138BK</b>
DODGE / RAM			
09-16	1500 Non-Air Ride	4WD 2.5"	<b>ULTKC09114BK</b>
09-17	1500 Non-Air Ride	2/4WD 1" rear	<b>ULTKC09116BK</b>
17-21	1500 Classic & NewBody (excl. Rebel)	4WD 2"	<b>ULTKC09139BK</b>
17-21	1500 Classic	2/4WD 1" rear	<b>ULTKC09140BK</b>
JEEP			
17-21	Compass Trailhawk	2/4WD 1.5"	<b>ULTKJ09172BK</b>

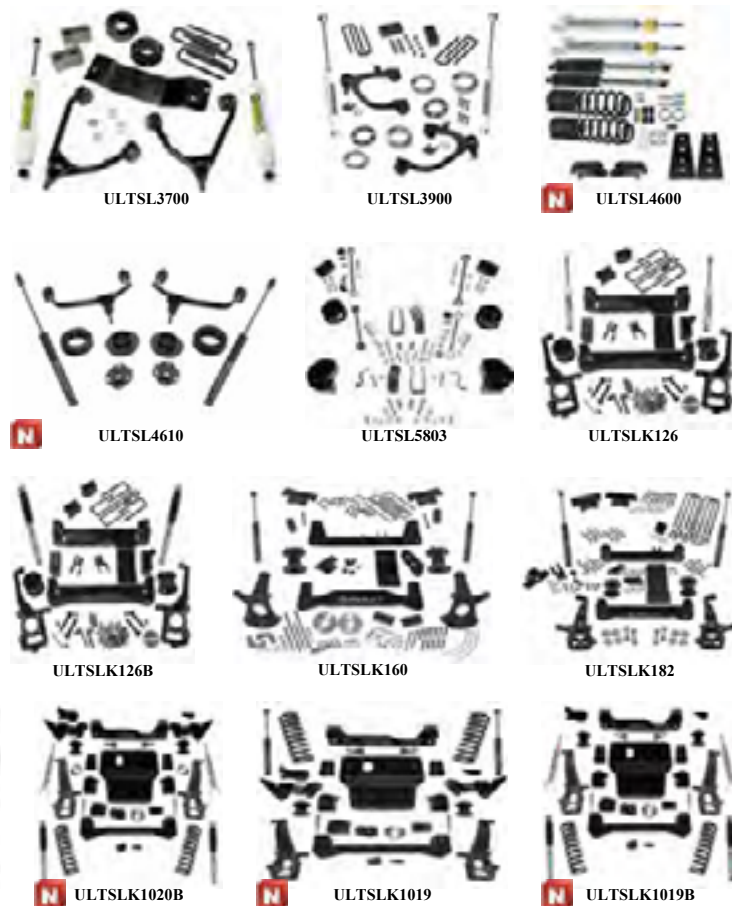

**LIFT KITS**

CHEVROLET / GMC			
19-22 Silverado/Sierra 1500 4WD New body	6" Lift kit with Alum/Steel ctrl arms		<b>ULTSLK182</b>
19-22 Silverado/Sierra 1500 4WD New body not Trailboss/AT4	6" Lift kit with Alum/Steel ctrl arms Bilstein Shocks		<b>ULTSLK182B</b>
19-22 Silverado/Sierra 1500 2/4WD New body not Trailboss/AT4	3" Front and 1.5" Rear Lift kit with Superlift Shocks		<b>ULTSL3900</b>
14-19 Silverado/Sierra 1500 4WD old body	3.5" Lift kit upper alum/steel control arms w/ Superlift shocks		<b>SULTL3600</b>
14-16 Silverado/Sierra 1500 4WD	6.5" Lift kit with OE Cast Steel upper control arms		<b>ULTSLK160</b>
07-16 Silverado/Sierra 1500 4WD	3.5" Lift kit Upper cast steel Cntrl arms w/ Superlift rear shocks		<b>ULTSL3700</b>
FORD			
15-20 F150 4WD not single cab or 2 pc rear driveshaft	4.5" Lift kit with Bilstein rear shocks		<b>ULTSLK126B</b>
15-20 F150 4WD not single cab	4.5" Lift kit with Superlift rear shocks		<b>ULTSLK126</b>
15-20 F150 4WD	6" Lift kit with SL Rear Shocks		<b>ULTSLK127</b>
JEEP			
<b>N</b> 18-23 Wrangler JL	2.5" Coil Spacer Lift Kit		<b>ULTSLK5803</b>
<b>N</b> 07-18 Wrangler JK 4 dr	4" Lift Kit with Reflex Ctrl Arms & Superlift Shocks		<b>ULTSLK997</b>
07-18 Wrangler JK 4 dr	4" Lift Kit with Reflex Ctrl Arms & Bilstein Shocks		<b>ULTSLK997B</b>
RAM			
<b>N</b> 09-22 Ram 1500 4WD (exc TRX4 or Outdoorsman)	2" Lift kit with Bilstein Struts and Shocks		<b>ULTSL4600</b>
<b>N</b> 19-22 Ram 1500 4WD	3" Lift kit w/o Factory Air Ride Suspension		<b>ULTSL4610</b>
<b>N</b> 12-18 Ram 1500 4WD (Classic 19-21)	6" Lift kit w/Superlift rear shocks		<b>ULTSLK1020</b>
<b>N</b> 12-18 Ram 1500 4WD (Classic 19-21)	6" Lift kit with Bilstein Struts and Shocks		<b>ULTSLK1020B</b>
<b>N</b> 12-22 Ram 1500 4WD	4" lift kit gas/diesel w/Superlift rear shocks		<b>ULTSLK1019</b>
<b>N</b> 12-22 Ram 1500 4WD	4" Lift Kit Bilstein Rear Shocks		<b>ULTSLK1019B</b>
TOYOTA			
07-20 Tundra 4WD	4.5" Lift kit w/ SL Rear shocks (non-TRD Pro/Rock Warrior/XSP-X)		<b>SULTLK963</b>

**LEVELING KITS**

- Gives up to 45 mm lift and is adjustable
- Specially designed to give comfortable ride empty or fully loaded
- The greasable swing shackle reduces body roll
- Three adjustments allow for varied loads: setting for light loads and upper settings for medium to heavy loads
- Superb handling, increased stability
- Quick no drill installation



CHEVROLET / GMC			
07-13 Avalanche	1.5" Front Strut spacer leveling kit		<b>ULTSL40012</b>
07-13 Avalanche	2" Front leveling kit		<b>ULTSL40012</b>
19-21 Silverado/Sierra 1500 not Trailboss/AT4/MagnaRide	2" Front leveling kit		<b>ULTSL40040</b>
08-19 Silverado/Sierra 1500 2/4WD old body	1.5" Front Strut spacer leveling kit		<b>SULTL40012</b>
08-19 Silverado/Sierra 1500 2/4WD old body	2" Front leveling kit		<b>ULTSL40012</b>
2007 Silverado/Sierra 1500 2/4WD not classic	1.5" Front Strut spacer leveling kit		<b>ULTSL40012</b>
2007 Silverado/Sierra 1500 2/4WD not classic	2" Front leveling kit		<b>ULTSL40012</b>
20-21 Silverado/Sierra 2500/3500 HD not MagnaRide	2.5" Front Leveling kit		<b>ULTSL40052</b>
11-19 Silverado/Sierra 2500/3500 HD	2.5" Front leveling kit		<b>ULTSL40025</b>
07-19 Suburban/Tahoe/Yukon	1.5" Front Strut spacer leveling kit		<b>ULTSL40012</b>
07-19 Suburban/Tahoe/Yukon	2" Front leveling kit		<b>ULTSL40012</b>
DODGE / RAM			
09-21 Ram 1500 Classic 4WD	1.75" Front leveling kit		<b>ULTSL40022</b>
14-21 Ram 2500/3500 not Power Wagon	2.5" Front leveling kit		<b>ULTSL40023</b>
19-21 Ram 1500 4WD not Rebel	2" Front leveling kit		<b>ULTSL40041</b>
12-21 Ram 1500 Classic not TRX/ or Factory Air-Ride suspension	2.5" Front/Rear leveling kit		<b>ULTSL40043</b>
12-21 Ram 1500 Classic 4WD not TRX/ or Factory Air-Ride suspension	2.5" Front leveling kit		<b>ULTSL40044</b>
FORD			
09-21 F150 2/4WD not 10-20 Raptor	1.75" Front leveling		<b>ULTSL40021</b>
05-21 F250/F350 Super Duty 4WD	2" Front leveling kit		<b>ULTSL40031</b>
05-21 F250/F350 4WD	2.5" Front leveling kit		<b>ULTSL40007</b>
19-21 Ranger 4WD	2" Front leveling kit		<b>ULTSL40050</b>
JEEP			
20-21 Gladiator JT/Rubicon/Sport/Sport S 4WD	2.5" Front leveling kit		<b>ULTSL40051</b>
TOYOTA			
05-21 Tacoma 2/4WD not Pro/XSP-X/ TX Baja or 5 lug wheels	2.5" Front strut ext kit		<b>ULTSL40045</b>
05-21 Tacoma/Prerunner 2/4WD not Pro/XSP-X/ TX Baja or 5 lug wheels	2" Front leveling kit/Alum Strut Spacer kit		<b>ULTSL40046</b>
07-21 Tundra 2/4WD not Pro series and XSP-X	2.5" Front leveling kit		<b>ULTSL40016</b>
<b>N</b> 07-22 Tundra 2/4WD	2" Front leveling kit		<b>ULTSL40018</b>





**REFLEX CONTROL ARMS**



**ULTSL5805**

JEEP  
 Gladiator 4 dr 20-23  
 Wrangler JL 2 dr 18-21  
 Wrangler JL 4 dr 18-23

- Helps prevent the track bar bracket from failure on a lifted JL or JLU
- Helps prevent unnecessary steering box issues such as wear, play or breakage
- Reinforces the Front Track bar
- Does not replace OEM track bar bracket
- Distributes increased loads on Front Track bar Bracket
- Super-EzBolt-on Application and installation



**REAR TRACK BAR BRACKET KIT**



Designed to center the rear axle, restore factory handling, and reduce body roll/rear steer.

**ULTSL5824**

JEEP  
 2023 Wrangler 4 Door  
 18-22 Wrangler 4 Door Rear Track Bar Bracket with Bolt On Reinforcement Brace 2.5 in - 4 in Lift Kit 4WD  
 18-21 Wrangler 2 Door Rear Track Bar Bracket with Bolt On Reinforcement Brace 2.5 in - 4 in Lift Kit 2 Door 4WD

**SHOCK KITS**

Wrangler JK 4 dr 07-18  
 Front And Rear Shocks for 2.5" - 4" Lift



**ULTSL84048**  
 Bilstein 5100



**ULTSL84047**  
 Superlift



**ULTSL84074**  
 FOX

Toyota Tundra 07-21  
 Rear Shocks for 4" - 6" Lift

**REFLEX CONTROL ARMS**



**ULTSL5772**  
 Wrangler JK 4 dr 07-18  
 Front lower



**ULTSL5774**  
 Wrangler JK 4 dr 07-18  
 Front upper



**ULTSL5773**  
 Wrangler JK 4 dr 07-18  
 Rear lower



**ULTSL5775**  
 Wrangler JK 4 dr 07-18  
 Rear upper

**LIFT KITS**



**CHEVROLET / GMC / CADILLAC**

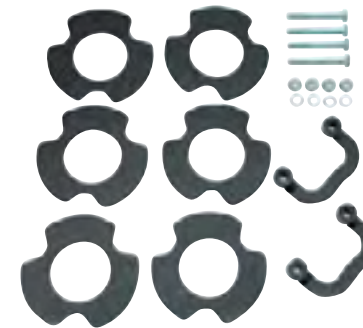

**ULTXX406010**  
 COILOVER - 6 LUG

	FRONT
07-13 Avalanche	1" - 2.5"
08-19 Escalade Hybrid	2WD/4WD 1" - 2.5"
07-19 Escalade	2WD/4WD 1" - 2.5"
07-19 Silverado / Sierra (2019 old body)	2WD/4WD 1" - 2.5"
09-18 Silverado / Sierra Hybrid	2WD/4WD 1" - 2.5"
07-19 Suburban / Yukon & XL	2WD/4WD 1" - 2.5"
07-19 Tahoe	2WD/4WD 1" - 2.5"
08-19 Tahoe Hybrid	2WD/4WD 1" - 2.5"
09-19 Yukon Hybrid	2WD/4WD 1" - 2.5"

Allows installation of tires up to 33" in height.



**ULTXX406037**  
 MAGNETIC RIDE

	FRONT	REAR
10-19 Silverado / Sierra 1500 ('19 old body)	4WD 2.5"	1"

Allows installation of tires up to 33" in height.



**ULTXX406039**  
 LEVELING KIT

	FRONT	REAR
07-18 Silverado/Sierra 1500	2WD 2.5"	1"

Allows installation of tires up to 33" in height.

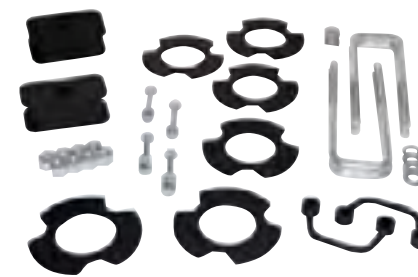

**ULTXX406034**  
 LEVELING KIT

	FRONT	REAR
19-21 Silverado/Sierra 1500	4WD 2.5"	2.5"

Allows installation of tires up to 33" in height.

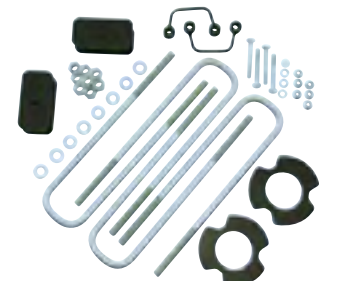

**ULTXX406035**  
 COILOVER - 6 LUG

	FRONT	REAR
07-19 Silverado / Sierra 1500 ('19 old body)	4WD 2.5"	1"
09-18 Silverado / Sierra Hybrid	4WD 2.5"	1"

Allows installation of tires up to 33" in height.





**LIFT KITS**

**DODGE / RAM**



**ULXXX605020**  
COILOVER

94-01 Ram 1500 4WD 8 lug	4WD	FRONT	2"
05-13 Ram Mega Cab 8 lug	4WD	FRONT	2"
94-13 Ram 2500/3500 8 lug	4WD	FRONT	2"

Allows installation of tires up to 35" in height.



**ULXXX604045**  
COILOVER

13-21 Ram Classic 1500 5 lug	4WD	FRONT	2"
------------------------------	-----	-------	----

Allows installation of tires up to 34" in height.



**ULXXX604014**  
LEVELING KIT

19-20 Ram 1500	FRONT	REAR	2.5"	1.25"
----------------	-------	------	------	-------

Allows installation of tires up to 35" in height.



**ULXXX604043**  
LEVELING KIT

09-18 Ram 1500	4WD	FRONT	REAR	2"	1.25"
----------------	-----	-------	------	----	-------

Allows installation of tires up to 34.5" in height.

**FORD / LINCOLN**



**ULXXX105010**  
COILOVER

04-19 F-150	2WD/4WD	FRONT	2"
-------------	---------	-------	----

Allows installation of tires up to 34" in height.



**LIFT KITS**

**FORD / LINCOLN**

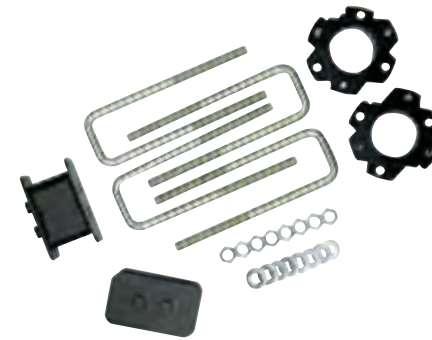

**ULXXX105015**  
COILOVER

09-20 F-150	4WD	FRONT	REAR	2"	1"
-------------	-----	-------	------	----	----

Allows installation of tires up to 34" in height.



**ULXXX108031**  
LEVELING KIT

05-22 F250/F350 SD	FRONT	2"
--------------------	-------	----

Allows installation of tires up to 34" in height.



**ULXXX108030**  
SPRING SPACER

05-22 F-250/350/450 SD	4WD	FRONT	2.5"
------------------------	-----	-------	------

Allows installation of tires up to 35" in height.

**JEEP**



**ULXXX601032**  
LEVELING KIT

18-22 Wrangler JL	FRONT	REAR	2.5"	2"
-------------------	-------	------	------	----

Allows installation of tires up to 35" in height.

**HONDA**



**ULXXX202041**  
LEVELING KIT

17-22 Ridgeline	FRONT	1.5"
16-22 Pilot	FRONT	1.5"

Allows installation of tires up to 31" in height.





**LIFT KITS**

**TOYOTA**



**ULTXX905015**  
COILOVER - 6 LUG

05-21 Tacoma	2WD/4WD	FRONT 3"	REAR 1.375"
--------------	---------	-------------	----------------

Allows installation of tires up to 33" in height.

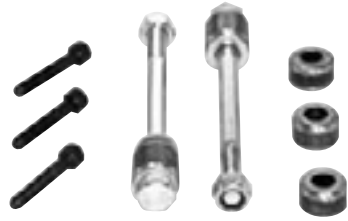

**ULTXX900025**  
FRONT DIFFERENTIAL  
DROP SPACER KIT

07-21 Tundra	2WD/4WD
--------------	---------



**ULTXX903035**  
LEVELING KIT

07-21 Tundra	2WD/4WD	FRONT 3"	REAR 2"
--------------	---------	-------------	------------



**ULTXX903010**  
COILOVER -  
5 LUG

08-21 Sequoia	2WD/4WD	FRONT 2"	
07-21 Tundra	2WD/4WD	FRONT 2"	

Allows installation of tires up to 33" in height.



**ULTXX903025**  
COILOVER -  
5 LUG

07-21 Tundra	2WD/4WD	FRONT 3"	REAR 1"
--------------	---------	-------------	------------

Allows installation of tires up to 34" in height.

**WIRELESS AIR COMMAND KIT WITH APP**



	LIGHT DUTY	STANDARD DUTY	HEAVY DUTY	EXTRA DUTY	EXTREME DUTY
Compressor included in kit					
Tank & air hose included in kit	Not included	Not included	Not included		
<b>SINGLE-LEVELING SYSTEMS</b> CONTROLS BOTH AIR SPRINGS EQUALLY					
ANALOG		<b>ULTRR2158</b>	<b>ULTRR2097</b>		
WIRELESS APP		<b>ULTRR2610</b>	<b>ULTRR2626</b>		
<b>DUAL-LEVELING SYSTEMS</b> CONTROL EACH AIR SPRING INDEPENDENTLY					
ANALOG		<b>ULTRR2178</b>	<b>ULTRR2219</b>	<b>ULTRR2168</b>	<b>ULTRR2549</b>



**AIR HELPER SPRINGS FOR REAR LEAF SPRINGS**



Keep the vehicle level - improve steering control and braking effectiveness, level headlight beams and reduce tire wear. Level off-center loads - individual inflation valves allow for adjustment side-to-side. Reduce suspension fatigue - keep leaf springs from permanent sagging under repeated or constant load. Reduce bottoming out - protective air cushion softens contact between the axle and frame. Increase vehicle stability - absorbing road shock providing ideal ride conditions for passengers and load.

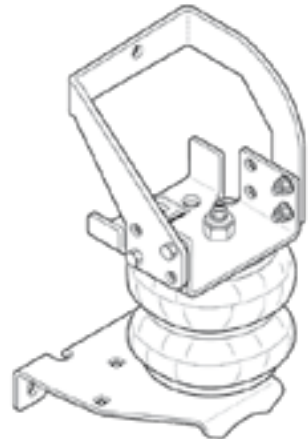

**NOTE 2:** \* Requires 6.5" of clearance between frame and tire (both single and dual rear wheels.)

**NOTE 3:** \* Requires 7.5" of clearance between frame and tire (both single and dual rear wheels.)

**NOTE 5:** \* Requires 9.5" of clearance between frame and tire (both single and dual rear wheels.)

**ULTA217-602-609**

Hardware Kit for RR2609

**ULTRR2135825889**

Lower Bracket for RR2609



Everything is included for a quick, easy installation. Brackets, air springs, hardware, air line, and separate valves for manual inflation. Average installation time is approximately 1-2 hours.



CADILLAC		
02-21	Escalade	ULTRR4108
CHEVROLET / GMC		
88-98	C/K 1500, 2500, 3500 Pick-up & Dually 2WD/4WD	ULTRR2025
73-87	C & R10, 20, 30, 1500, 2500, 3500 2WD All models	ULTRR2071 <sup>3</sup>
19-22	Silverado / Sierra 1500	ULTRR2609
07-19	Silverado / Sierra 1500 old body	ULTRR2430
99-07	Silverado / Sierra 1500 2WD/4WD <b>Classic</b>	ULTRR2320 <sup>2</sup>
11-22	Silverado / Sierra 2500/3500, 2WD/4WD	ULTRR2825
20-22	Silverado / Sierra 2500/3500, 2WD/4WD	ULTRR2613
20-22	Silverado / Sierra 2500/3500, 2WD/4WD <b>Red Label</b>	ULTRR2709
01-10	Silverado / Sierra 2500/3500 HD, 2WD/4WD	ULTRR2250
01-10	Silverado / Sierra 2500/3500 HD, 2WD/4WD <b>Red Label</b>	ULTRR2700
12-22	Silverado / Sierra 3500 HD Cab-Chassis, 2WD/4WD	ULTRR2715
00-21	Suburban, Yukon, Tahoe 1500 2WD/4WD	ULTRR4108
CHRYSLER		
08-16	Town and Country	ULTRR4169
DODGE / RAM		
08-16	Caravan, Grand Caravan	ULTRR4169
77-99	Ram 100-350, 1500, 2500, 3500 Pick-up & Dually Pick-up, (97-99 1 ton w/o contact overloads) 2WD/4WD	ULTRR2071 <sup>3</sup>
19-22	Ram 1500 new body 2WD/4WD (Ride-Rite) not Power Ram or Rebel	ULTRR4130
19-22	Ram 1500 Classic 2WD/4WD (Ride-Rite) not Power Ram or Rebel	ULTRR2595
09-18	Ram 1500 2WD/4WD (Ride-Rite) not Power Ram or Rebel	ULTRR2595
09-18	Ram 1500 2WD/4WD (Coil-Rite) not Power Ram or Rebel	ULTRR4185
02-08	Ram 1500 2WD/4WD	ULTRR2286
94-01	Ram 1500 2WD/4WD	ULTRR2071 <sup>5</sup>
14-22	Ram 2500 2WD/4WD	ULTRR2598
14-22	Ram 2500 2WD/4WD <b>Red Label</b>	ULTRR2706
03-09	Ram 2500/3500 Pick-up 2WD/4WD & Mega cab	ULTRR2299
03-09	Ram 2500/3500 Pick-up 2WD/4WD & Mega cab <b>Red Label</b>	ULTRR2701

**AIR HELPER SPRINGS FOR REAR LEAF SPRINGS**



**ABSORBS EXTREME SHOCK**  
Capable of withstanding sudden left-to-right or side-to-side changes in suspension travel

**AIR-ONLY DESIGN**  
Smooth ride and high performance, riding on a cushion of air

**WORRY-FREE MAINTENANCE**  
Durable bellow won't rip or pull apart when suspended on a lift

**LONG PRODUCT LIFE**  
Built to last using commercial-grade steel plates with rolled crimp design for a long life under your vehicle

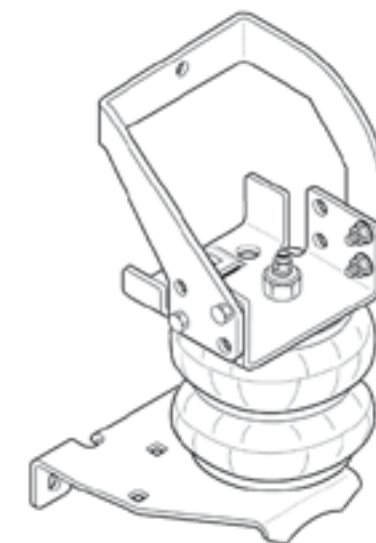

**NOTE 3:** \* Requires 7.5" of clearance between frame and tire (both single and dual rear wheels.)

**NOTE 4:** \* Requires 8.00" of clearance between frame and tire (both single and dual rear wheels.)

DODGE / RAM (cont.)		
77-02	Ram 2500/3500 Pick-up 2WD/4WD	ULTRR2071 <sup>3</sup>
14-22	Ram 3500 2WD only	ULTRR2616
13-22	Ram 3500 4WD only	ULTRR2615
13-22	Ram 3500 4WD only <b>Red Label</b>	ULTRR2710
FORD		
90-96	Bronco 4 x 4	ULTRR2071 <sup>3</sup>
68-96	F100, F150, F250, F350 2WD/4WD	ULTRR2071 <sup>3</sup>
15-22	F150 2WD/4WD	ULTRR2582
09-14	F150 2WD/4WD <b>not</b> Raptor or FX2	ULTRR2525
17-22	F250 2WD only	ULTRR2600 <sup>3</sup>
17-22	F350 DRW 4WD	ULTRR2624
17-22	F250/350 4WD	ULTRR2625
17-22	F250/350 4WD <b>Red Label</b>	ULTRR2716
17-22	F250/350 SRW AIO Analog	ULTRR2827
11-16	F250/350 2WD/4WD	ULTRR2597
11-16	F250/350 2WD/4WD <b>Red Label</b>	ULTRR2703
11-16	F250/350 2WD/4WD (Diesel)	ULTRR2535
08-10	F250/350 2WD/4WD	ULTRR2550
99-04	F250 2WD/4WD over 8600 GVW	ULTRR2550
99-04	F350 2WD not V10 gas with extended cab and 8' bed	ULTRR2550
99-04	F350 4WD	ULTRR2550
97-08	F250/350 SD over 8600 GVW 2WD/4WD	ULTRR2071 <sup>3</sup>
11-14	F350 2WD only (Diesel)	ULTRR2071 <sup>3</sup>
17-22	F450 2WD/4WD	ULTRR2625
17-22	F450 2WD/4WD <b>Red Label</b>	ULTRR2716
17-22	F450 2WD/4WD	ULTRR2624
11-14	F450 2WD/4WD	ULTRR2535
11-13	F450 2WD/4WD <b>Red Label</b>	ULTRR2703
19-21	Ranger 2WD/4WD	ULTRR2614
13-22	Transit 250/350 SRW	ULTRR2621
13-22	Transit 350 DRW	ULTRR2603
TOYOTA		
05-22	Tacoma 2WD only, axle above leaf springs	ULTRR2410
05-22	Tacoma Prerunner 2WD	ULTRR2407
05-22	Tacoma 4WD	ULTRR2407
07-21	Tundra 2WD/4WD	ULTRR2445



**Firestone**

**AIR HELPER SPRINGS FOR FRONT COIL SPRINGS**



CHEVROLET / GMC	
63-87 Blazer & Suburban: 2WD	ULTRR4100
73-87 C & R10, 20, 30, 1500, 2500, 3500 2WD	ULTRR4100
70-95 Motorhome Class C & Vans	ULTRR4100
63-99 Motorhome P30 / P32 / GP30 class A	ULTRR4100
63-87 Pick-up 1/2, 3/4 & 1 ton	RULTR4100
FORD	
75-07 E100/150/250/350 Van 1/2, 3/4 & 1 ton & Class "C"	ULTRR4101
96-07 E450 Super Duty commercial chassis	ULTRR4101
08-16 F250 2WD only	ULTRR4101
69-07 F250, F350 2WD	ULTRR4101
08-16 F350 2WD only	ULTRR4101

**ACCESSORIES**

Continuously monitor your air helper springs with the air pressure monitor kit. Can be installed on any air spring system. Complete with gauge, bracket and all necessary installation hardware.



ULTRR2196  
0-150 PSI



ULTRR2191  
0-150 PSI.  
With electric switch



ULTRR9039  
Replacement switch

**AIR TANK**

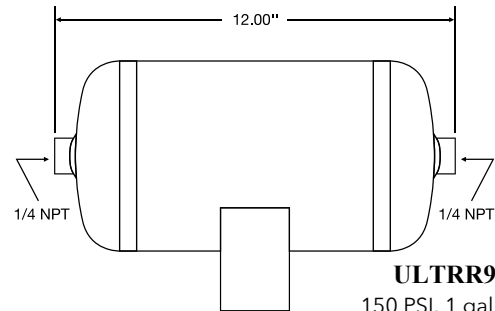

ULTRR9125  
150 PSI. 1 gal. 6" dia.

**PRESSURE SWITCH**



ULTRR9016  
1/8 NPT Male  
90-120 PSI

**FITTINGS**



ULTRR3101  
1/4" NPT x 1/4" TUB  
90° • Pack: 25



Valve inflation fitting  
1/4 NPT

ULTRR3098-1  
Unit  
ULTRR3098  
Pack: 25

**UNION**



ULTRR3079-1  
1/4" Unit  
ULTRR3079  
1/4" Unit  
Pack: 25

**"T" UNION**



ULTRR3025-1  
1/4" Unit  
ULTRR3025  
1/4" Unit  
Pack: 25

**Firestone**

**HEAVY DUTY COMPRESSOR**

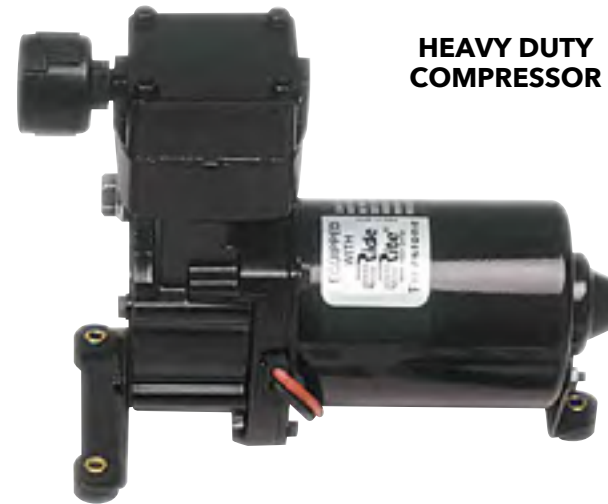

ULTRR9335  
12 VOLT. • 145 PSI. • 1/8" NPT

**HOSE KIT AND CONNECTING T**



ULTRR2012  
Includes 18' of red 1/4" air line, two 1/4 NPT elbow fittings one union tee and two inflation valves.

**REPLACEMENT BELLOWS**



ULTRR6397  
Air inlet: 1/8 NPT  
Ride Height: 5.50"-6.50"  
Max. Diameter: 6.6" For:  
ULTRR2350



ULTRR6401  
Air inlet: 1/4 NPT  
Combo stud: 3/4" - 16  
Ride Height: 5.50"-7.00"  
Max. Dia.: 7.52"



ULTRR6781  
Air inlet: 1/4 NPT  
Ride Height: 5.50"-6.50"  
Max. Dia.: 6.60"  
For : ULTRR2071



ULTRR9002  
Air inlet: 1/4 NPT  
Ride Height: 7.25"  
Max. Dia.: 6.60"  
**CHEVROLET / GMC**  
88-98 Silverado/Sierra 1500 2WD only  
**DODGE**  
97-03 Dakota 4WD only not Crew Cab  
97-02 Durango 2WD/4WD not SXT  
94-01 Ram 1500 2WD only  
03-06 Sprinter 2500 2WD only  
**FORD**  
98-14 E250



ULTRR9000  
Air inlet: 1/4 NPT  
Ride Height: 8.25"  
Max. Dia.: 5.70"



**AIR SPRING KITS**

**LoadLIFTER 7500XL**



- Up to 7,500 lb of load-leveling capacity
- Massive 7-inch double-convoluted-bellow air springs creates a better ride than most products with similar weight ratings
- End caps made of ultra high-strength, corrosion-proof, nylon composite which is as strong as steel but weighs less and will not rust
- All kits are compatible with most 5th wheel and gooseneck hitches

**LoadLifter PRO Series ULTIMATE**



- Up to 5,000 lb of load-leveling capacity
- Anodized aluminum end caps for added durability
- Stainless steel hardware
- Jounce bumper inside gives added protection when towing or hauling heavy loads

**LoadLIFTER 5000 ULTIMATE PLUS+**



- Up to 5,000 lb of load-leveling capacity
- Stainless steel roll plates which protect the air springs and help increase load capacity of the springs by up to 10%
- Stainless steel braided air lines for added protection against sharp edges and road debris
- Stainless steel air spring mounting hardware
- Jounce bumper inside the air spring absorbs shock and can be safely run with zero air pressure
- Military-grade AN fittings for leakfree system with no air line cutting required

**REPLACEMENT AIR SPRING**  
for LOADLIFTER 5000 PLUS ULTIMATE



- **ULTALC84301**
- Max. Air Pressure: 100 psi
- Min. Air Pressure: 5 psi
- Capacity: 5000 lb
- Material: Rubber

CHEVROLET / GMC		LL7500XL	LLPROSERIES	LL5000PLUS
19-22 Silverado 1500 New Body	2WD / 4WD	--	--	ULTALC89288
07-19 Silverado/Sierra 1500 GMT 900 series Old body	2WD / 4WD	--	--	ULTALC89204
20-21 Silverado/Sierra 2500/3500HD	4WD	--	--	ULTALC89341
11-19 Silverado/Sierra 2500/3500HD	2WD / 4WD	--	--	ULTALC89338
11-19 Silverado/Sierra 2500/3500HD	4WD	ULTALC57538	--	ULTALC89338
01-10 Silverado/Sierra 2500/3500HD	2WD / 4WD	--	ULTALC94275	--
DODGE / RAM				
19-22 Ram 1500 1/2 Ton. Pickup	2WD / 4WD	--	--	ULTALC89375
19-22 Ram 1500 Classic	2WD / 4WD	--	--	ULTALC89365
09-18 Ram 1500	2WD / 4WD	--	--	ULTALC89365
19-22 Ram 3500	2WD / 4WD	ULTALC57531	--	--
03-18 Ram 3500	4WD	ULTALC57595	--	--
FORD				
15-21 F150	4WD	--	--	ULTALC89385
19-21 F250/350/450 Super Duty	4WD	ULTALC57577	--	--
17-21 F250/350	4WD	--	--	ULTALC89399
17-21 F450	4WD	--	--	ULTALC89399

**AIR SPRING KITS**

AIRLIFT SPRINGS PUT AN END TO THESE COMMON PROBLEMS:

**LoadLifter 5000<sup>™</sup> ULTIMATE**

Internal jounce bumper absorbs shock

Fits most 3/4 to 1 ton applications



**UP TO 5000 LB OF LOAD LEVELING CAPACITY**

**LoadLifter 5000<sup>™</sup>**

Fits most 3/4 to 1 ton applications



**UP TO 5000 LB OF LOAD LEVELING CAPACITY**

**RideControl<sup>™</sup>**

Fits most 1/2 ton applications



**UP TO 2000 LB OF LOAD LEVELING CAPACITY**

**Air Lift 1000<sup>™</sup>**

Fits open coil springs on the front or rear

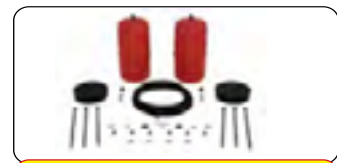

**UP TO 1000 LB OF LOAD LEVELING CAPACITY**

CHEVROLET / GMC		LL5000 ULTIMATE	LOADLIFTER5000	RIDECNTRL	AIRLIFT1000
88-98 C1500 Pick-up	2WD	---	---	ULTALC59501	---
88-98 C/K Pick-up	4WD	---	---	ULTALC59501	---
19-23 Silverado/Sierra 1500 New Body	2WD / 4WD	---	ULTALC57288	---	---
07-19 Silverado/Sierra 1500 GMT 900 series old body	2WD / 4WD	---	---	ULTALC59565	---
99-07 Silverado/Sierra 1500 Classic	2WD / 4WD	---	---	ULTALC59501	---
01-05 Silverado/Sierra 1500 HD	2WD / 4WD	---	---	ULTALC59501	---
11-19 Silverado/Sierra 2500/3500HD	2WD / 4WD	ULTALC88338	ULTALC57338	---	---
01-10 Silverado/Sierra 2500 HD	2WD / 4WD	---	ULTALC57275	---	---
DODGE / RAM					
87-04 Dakota	4WD	---	---	ULTALC59501	---
00-01 Dakota RT	2WD	---	---	ULTALC59501	---
14-21 Promaster 1500/2500/3500	2WD / 4WD	ULTALC88233	ULTALC57233	---	---
19-22 Ram 1500	2WD / 4WD	---	---	---	ULTALC60828HD
19-21 Ram 1500 1/2 Ton.	2WD / 4WD	ULTALC88375	---	---	---
19-22 Ram 1500 Classic	2WD / 4WD	---	ULTALC88365	---	ULTALC60818
09-18 Ram 1500	2WD / 4WD	---	ULTALC88365	---	ULTALC60818
94-01 Ram 1500	2WD / 4WD	---	---	ULTALC59501	---
94-01 Ram 1500 1/2 Ton. For heavy loads or commercial use	2WD / 4WD	---	ULTALC57215	---	---
14-22 Ram 2500/3500	2WD / 4WD	---	ULTALC57289	---	---
03-13 Ram 2500	4WD	---	ULTALC57295	---	---
94-02 Ram 2500 3/4 Ton.	2WD / 4WD	---	ULTALC57215	---	---
19-22 Ram 3500	2WD / 4WD	---	ULTALC57231	---	---
03-15 Ram 3500	4WD	---	ULTALC57295	---	---
FORD					
09-14 F53 Motorhome	2WD	---	ULTALC57344	---	---
15-21 F150	2WD	---	ULTALC57268	ULTALC59570	---
15-21 F150	4WD	---	ULTALC57385	ULTALC59570	---
10-14 F150	2WD / 4WD	---	---	ULTALC59568	---
2004 F150 Heritage	2WD / 4WD	---	---	ULTALC59501	---
97-03 F150	2WD / 4WD	---	---	ULTALC59501	---
68-96 F150	2WD	---	---	ULTALC59501	---
17-19 F250/350 SD	4WD	ULTALC88399	ULTALC57399	---	---
11-16 F250/350	4WD	ULTALC88396	ULTALC57396	---	---
17-21 F450 SD	4WD	---	ULTALC57399	---	---
11-14 F450	4WD	ULTALC88396	ULTALC57396	---	---
19-21 Ranger	2WD / 4WD	---	ULTALC57234	---	---
JEEP					
20-23 Gladiator	4WD	---	---	---	ULTALC60830
TOYOTA					
07-21 Tundra	2WD / 4WD	ULTALC88299	---	---	---



### AIR SPRING KITS

#### LoadCONTROLLER



Inflate / Deflate

Single path control provides equal inflation of both air springs. Low pressure sensor automatically activates the air compressor if air spring pressure falls below safe level.



**ULTALC25854**  
With heavy duty compressor



**ULTALC25850**  
With standard compressor

#### LoadCONTROLLER II



**ULTALC25592**

Single gauge. Levels vehicle side to side. 5 PSI low pressure sensor



#### Air ShockCONTROLLER



**ULTALC25804**  
160 PSI

Onboard compressor, dash mounted gauge panel, hardware and lines

#### WirelessONE

2<sup>nd</sup> Generation



**ULTALC25980**

Single path controller: Left and right air springs are inflated/deflated equally below safe level. Wireless handheld unit and New mobile app for convenient operation inside or outside the vehicle. Easy installation- no air lines to the cab! Three programmable, user-defined memory settings.



**ULTALC25980EZ**  
With EZ Mount

#### WirelessAIR

WIRELESS



**ULTALC74000**

WirelessAir provides one-touch inflation and deflation of your air springs from inside or outside the vehicle. Control the air like a boss.



**ULTALC73000EZ**

Control System App Only, No Controller w/EZ Mount

#### LifeSTYLE REPLACEMENT AIR BAGS



RIDE CONTROL

**ULTALC50203**  
For:  
**ULTALC59501**

**ULTALC60318**  
For:  
**ULTALC60818**

#### UNIVERSAL AIR SPRING SPACERS

Works with all brands of bellows-style air springs (including Air Lift's LoadLifter 5000 series and Loadfilter 7500XL). Made with high-grade 1/4" steel and rated to handle over 10 tons of force. Attaches between lower air spring bracket and the air spring. Unique spinal design makes it easy to attach air springs using the provided hardware.



**ULTALC52420**  
2-inch straight

**ULTALC52440**  
4-inch straight

**ULTALC52460**  
6-inch straight

## Solving Suspension Problems



- Eliminate Sag & Sway
- Optimize Load Handling
- Improve Roll Stability
- Cushion Road Shocks
- Improve Ride Control
- Maintenance Free

**Easy Bolt-On**

**Lifetime Warranty**



#### REAR SUSPENSION KITS

CHEVROLET / GMC		
01-07	Silverado / Sierra 1500 HD Classic 2/4WD	ULTGMRCK25S
99-21	Silverado / Sierra 1500 (coil front spring) 2/4WD	ULTGMRCK15S
99-06	Silverado / Sierra 1500 (except 4 door) Classic 2/4WD	ULTGMRCK15S
99-06	Silverado / Sierra 1500 (4 door) Classic 4WD	ULTGMRCK15S
11-21	Silverado / Sierra 2500 & 3500 2/4WD	ULTGMRCK25D
99-07	Silverado / Sierra 2500 HD Classic 2/4WD	ULTGMRCK25S
CHRYSLER / DODGE / RAM		
08-21	Grand Caravan 2/4WD	ULTDVRRT
09-22	Ram 1500 Crew Cab & Quad Cab 2/4WD	ULTDR1500DQ
09-22	Ram 1500 not Quad Cab 2/4WD	ULTDR1500DS
06-08	Ram 1500 not Mega Cab 2/4WD	ULTDR1525H4
06-08	Ram 1500 Mega Cab 2/4WD	ULTDR2500CA
02-05	Ram 1500 2/4WD	ULTDR2500CA
94-01	Ram 1500 / 2500 4WD	ULTDR1525H4
03-14	Ram 2500 2/4WD	ULTDR2500CA
08-21	Town & Country 2/4WD	ULTDVRRT

#### REAR SUSPENSION KITS

FORD / LINCOLN		
15-22	F150 2/4WD	ULTFR1504E
09-15	F150 2WD	ULTFR1502D
09-14	F150 4WD	ULTFR1504D
04-08	F150 not Heritage / Mark LT 2WD	ULTFR1502D
04-08	F150 not Heritage 4WD	ULTFR150D
17-22	F250 2/4WD	ULTFR250SDJ
11-16	F250 Super Duty 2/4WD	ULTFR250SDG
06-08	Mark LT 4WD	ULTFR150D
16-21	Ranger 2/4WD	ULTFRRGR
TOYOTA		
00-22	Tundra 2/4WD	ULTTORTUN4

#### FRONT SUSPENSION KITS

CHEVROLET / GMC		
99-07	Silverado / Sierra (w/ front cast lower control arm) Classic 4WD	ULTGMFK25S
01-07	Silverado / Sierra 1500 HD Classic 2/4WD	ULTGMFK25S
99-07	Silverado / Sierra 1500 (except 4 door) Classic 2WD	ULTGMFK25S
99-07	Silverado / Sierra 2500 HD Classic 2/4WD	ULTGMFK25S
01-07	Silverado / Sierra 3500 Classic 2/4WD	ULTGMFK25S



**SUSPENSION STABILIZERS**



**RTX**



- Gives up to 45 mm lift and is adjustable
- Specially designed to give comfortable ride empty or fully loaded
- The greasable swing shackle reduces body roll
- Three adjustments allow for varied loads: setting for light loads and upper settings for medium to heavy loads
- Superb handling, increased stability
- Quick no drill installation

CHEVROLET / GMC	LD	HD	DODGE / RAM (CONT.)	LD
95-05 Astro, Safari	ULT6513		98-20 Durango	ULT6513
88-98 C/K Pick-Up 1500	ULT6513		14-19 Promaster 1500, 2500, 3500	ULT7015
15-20 Colorado, Canyon 2WD/4WD	ULT6513		94-08 RAM 1500 2WD/4WD	ULT6513
96-20 Express, Savana G1500, G2500, G3500	ULT6513		94-19 RAM 2500, 3500 2WD/4WD	ULT7513 ULT7514
99-10 K1500, K2500 Motorhome Chassis	ULT6513		<b>FORD</b>	
11-19 Silverado/Sierra 1500 old body 2WD/4WD	ULT6513		07-15 E100, E150 Van	ULT7513 ULT7514
99-10 Silverado/Sierra 1500, 1500HD, 2500, 2500HD, 3500 2WD/4WD	ULT6513		92-19 E250, E350, E450, E450SD	ULT7513 ULT7514
11-19 Silverado / Sierra 2500HD, 3500HD 2WD/4WD	ULT7513	ULT7514	04-20 F150 2WD/4WD (not Heritage)	ULT7513 ULT7514
85-20 Suburban, Tahoe, Yukon 2WD/4WD	ULT6513		97-03 F150 2WD/4WD	ULT6513
<b>DODGE / RAM</b>			99-19 F250SD, F350SD, F450SD 2WD/4WD	ULT7513 ULT7514
98-03 B150, B250, B350 Motorhome Chassis	ULT6513		04-11 Ranger 2WD/4WD	ULT6513
96-07 Caravan	ULT6513		15-20 Transit Connect	ULT7513 ULT7514
87-11 Dakota 2WD/4WD	ULT6513		<b>MERCEDES</b>	
			02-20 Sprinter 2500, 3500	ULT7015



**STABLELOAD REAR SUSPENSION UPPER OVERLOAD SPRINGS**

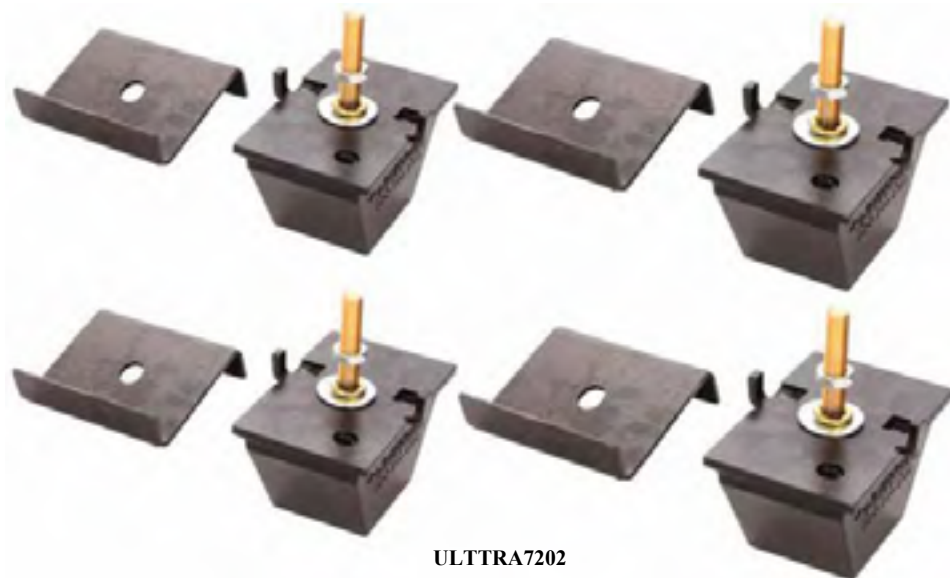

ULTRA7202

The upper factory overload springs on your truck are designed to help compensate for a large payload. When you are hauling a heavy load, your truck's standard leaf springs can't always counteract the weight of it. As a result, if you hit a bump when your suspension is fully loaded, the leaf springs will give and cause your truck to bottom out. The overload springs help keep this from happening by mounting above the leaf springs to provide initial points of contact for your vehicle's frame, thus removing some of the load from the standard springs.

**SUSPENSION STABILIZERS**



**INCREASE SPRING RATE & STABILITY**

- 2000 lb level load capacity
- Can be adjusted independently for uneven side to side loads
- Mounts under factory axle U-bolt plates

**LIFETIME WARRANTY**

CHEVROLET / GMC Full Size Pickup & Suv	ULTEZ-990	FORD Full Size Pickup & Suv
07-22 Silverado/Sierra 1500: 2WD, 4WD	ULTHW987 <sup>2</sup>	15-18 F150: 2WD, 4WD 09-14 F150: 2WD, 4WD
		ULTHW978 ULTHW989 <sup>2</sup>

**PRO-SERIES**

- 2500 lb level load capacity
- Bolt on design
- System enables trucks to carry loads with more stability and control
- Set it and forget it



**SILENT RIDE FEATURE**

- With unique polyurethane block applies tension to the u-bolts to maintain a quiet ride.
- Also stabilizes the helper spring in reverse or rebound mode

CHEVROLET / GMC FULL SIZE PICKUP & SUV	PRO-SERIES	DODGE / RAM FULL SIZE PICKUP	
73-87 C10, K10 Pickup	ULTHW61902	70-93 D100 Pickup: 2WD	
73-87 C20, K20 Pickup	ULTHW61902	70-93 D200/300 Pickup: 2WD	
88-98 C&K 1500 Pickup	ULTHW61902	70-93 W150 Pickup: 4WD	
88-98 C&K 2500 Pickup	ULTHW61902	70-93 W250 Pickup: 4WD	
88-98 C&K 3500 Pickup	ULTHW61902 <sup>1</sup>	94-02 Ram 1500 D&W Series: 2WD, 4WD	
67-72 K10, K20 Pickup & Suburban	ULTHW61902	94-02 Ram 2500/3500 D&W Series 2WD, 4WD (1)	
07-18 Silverado/Sierra 1500: 2WD, 4WD	ULTHW61902	<b>FORD FULL SIZE PICKUP &amp; SUV</b>	
2007 Silverado/Sierra 1500 Classic: 2WD	ULTHW61902	67-96 Bronco Full Size	ULTHW61902
2007 Silverado/Sierra 1500 Classic: 4WD	ULTHW61902	73-79 F100/150: 2WD, 4WD	ULTHW61902
99-06 Silverado/Sierra 1500: 2WD	ULTHW61902	65-72 F100: 2WD	ULTHW61902
99-06 Silverado/Sierra 1500: 4WD	ULTHW61902	73-79 F250: 2WD	ULTHW61902
<b>CHEVROLET / GMC FULL SIZE VAN</b>		65-72 F250: 2WD	ULTHW61902
07-13 Express Van 1500 - 3500 w/o rear A/C	ULTHW61902	67-79 F250: 4WD	ULTHW61902

<sup>1</sup> - Must remove factory overload contact springs <sup>2</sup> - Step bracket style leaf



## HELPER SPRING KITS

### Load Pro 15 - 1500 lb



**ULTHW815**  
 86-05 Chevrolet Astro  
 1994 Chevrolet S10 Blazer  
 98-04 Dodge Dakota  
 90-93 Dodge Dakota  
 98-03 Dodge Durango  
 92-01 Ford Explorer  
 1991 Mazda Navajo  
 97-01 Mercury Mountaineer  
 1994 Oldsmobile Bravada  
 96-03 Oldsmobile Bravada  
 95-99 Toyota Tacoma  
 95-99 GMC Jimmy  
 88-05 GMC Safari



**ULTHW1515**  
 76-82 Chevrolet LUV  
 72-74 Chevrolet Luv Pickup  
 83-93 Chevrolet S10 Blazer  
 90-10 Dodge Dakota  
 78-82 Ford Courier  
 73-76 Ford Courier  
 85-93 GMC Jimmy  
 82-83 GMC Jimmy  
 83-91 GMC S15 Jimmy  
 79-84 Mazda B2000  
 87-93 Mazda B2200  
 91-93 Oldsmobile Bravada  
 95-04 Toyota Tacoma

### Load Pro 25 - 2500 lb



**ULTHW2511**  
 11-21 Ford F250/350  
 16-21 Ford F450/550

**ULTHW25301** Install Kit  
 Required Must remove factory  
 overload contact springs or  
 use contact overload helper.

### Load Pro 35 - 3500 lb



**ULTHW3511**  
 11-22 Ford F250/350  
 17-21 Ford F450  
 16-21 Ford F250/350/450/550 Cab & Chassis

**ULTHW25301** Install Kit Required  
 Do Not Use w/Factory Overload Contact Springs  
 or use **HW9703**.

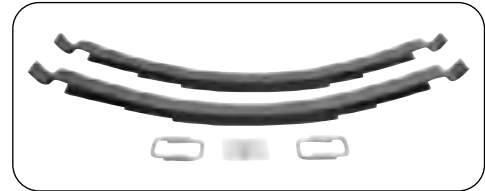

**ULTHW3520**  
 94-00 Dodge Ram 1500  
 97-98 Dodge Ram 1500  
 94-02 Dodge Ram 2500/3500  
 99-07 Ford F-250 Super Duty  
 1999 Ford F-250  
 77-97 Ford F-250  
 01-07 Ford F-350 Super Duty  
 1999 Ford F-350 Super Duty  
 80-97 Ford F-350

**ULTHW25250**  
 Install Kit  
 Required

### CONTACT HELPER SPRINGS



- Increases rate when loaded but factory ride when empty
- Easy installation

#### FORD

16-22 F250/350 **ULTHW9706**  
 99-16 F250/350 SD **ULTHW9703**

#### CHEVROLET/GMC

20-22 Silverado/Sierra 3500 HD **ULTHW9703**

### EZ-550 HELPER SPRING KIT



- Level Load Capacity up to 500lb
- Easy Installation

#### CHEVROLET/GMC

15-22 Colorado/Canyon **ULTHW553**

### FRONT



ULTHW7217

**CHEVROLET/GMC**

#### FORD

08-14 E150/250/350 2WD **ULTHW7718**  
 99-20 F53 Motorhome/F59 V10 **ULTHW7718**  
 09-20 F150 2WD/4WD **ULTHW7704**  
 11-22 F250/350 SD 4WD **ULTHW7712**  
 99-04 F250/350 SD 4WD **ULTHW7640**

### SWAY BARS

- Level Load Capacity up to 500lb
- Ideal for small trucks and SUV's
- Easy Installation

### REAR

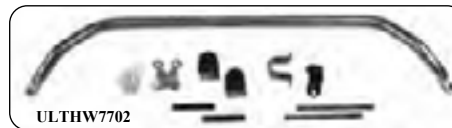

ULTHW7702

#### CHEVROLET/GMC

15-22 Colorado/Canyon **ULTHW7745**  
 97-15 G2500/3500/Savana **ULTHW7635**  
 14-18 Silverado/Sierra 1500 2WD/4WD **ULTHW7735**  
 99-13 Silverado/Sierra 1500/1500HD/2500 **ULTHW7800**

#### FORD

00-05 Excursion 2WD/4WD **ULTHW7643**  
 15-21 F150 2WD/4WD **ULTHW7743**  
 99-07 F150 2WD/4WD **ULTHW7705**  
 17-22 F250/350 SD 4WD **ULTHW7761**

### BIG WIG • REAR



ULTHW7269

#### CHEVROLET/GMC

0 -0 Silverado/Sierra 00/ 00 / / **ULTHW7269**

#### FORD

11-16 F250/350 SD 4WD **ULTHW7271**



HW7271