

ULTRACAR HITCHES



**AU SERVICE
DES CONCESSIONNAIRES
TEXTO INFO: 514-592-0005**

**depuis 1982
2023
514.592.0005**



**Suivez-nous Instagram
ultracar.1982**

www.ultracar.com

ULTRACAR

REESE

5TH WHEEL HITCHES

• PRO SERIES •

WITHOUT RAIL

Use with rail and installation kit **ULTR30035** (Sold separately)



ULTR30047
16,000 - 4,000 lb

- Double jaw system lock
- Adjustable height: 15" to 18"
- Slider gives 10" travel
- Pivot head from left to right 4° to 5°



ULTR30119
20,000 - 5,000 lb

- Double jaw system lock
- Adjustable height 13" to 17"
- Full floating head

WITH RAILS

Includes rail and installation kit **ULTR30035**



ULTR30132
20,000 - 5,000 lb

- Double jaw system lock
- Adjustable height: 13" to 17"
- 10 bolt rail
- Full floating head

WITH SLIDER AND RAILS

Includes rail and installation kit **ULTR30035**



ULTR30129
15,000 - 3,750 lb

- Flat bar locking system
- Adjustable height: 13" to 17"
- Slider gives 10" travel
- 10 bolt rail
- Pivot head from left to right 5°

REESE

5TH WHEEL HITCHES WITH SLIDER, WITHOUT RAILS

Use with rail and installation kit ULTR30035 (Sold separately)



ULTR30051
16,000 - 4,000 lb

- Double jaw system lock
- **ULTR30047** + KWIK-SLIDE (ULTR30048).
- Slider gives 10" travel
- Adjustable height: 15" - 18"
- **Pivot head** from left to right 4° to 5°

SLIDER

KWIK-SLIDE™



ULTR30048

Fifth wheel slider giving 10" travel providing greater turning clearance for short bed trucks.

Use with **ULTR30035** rail and installation kit (Sold separately).

Fits both **15K** & **16K** models. Travel: 10".

MOUNTING KIT ADAPTERS

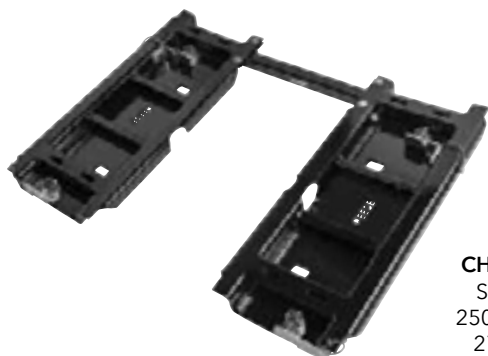

ULTR30899
CHEVROLET / GMC
Silverado / Sierra
2500/3500 HD 16-22
27,000 - 6,750 LB



ULTR30154
RAM 2500/3500 13-22
With OEM rail under the bed



ULTR30156
For **15K, 16K & 20K**
standard wheel hitches
(for use with OEM Under-rail kit :
FORD F250/350 SD 11-22
with Prep Pkg)

REESE

• M5 SERIES • • UNDER BED INSTALLATION •

5TH WHEEL HITCHES M5 SERIES



Experience the quietest and smoothest tow possible thanks to a wider stance, tighter tolerances, and industry leading shock dampening system. You might even forget you are towing! By combining the latest in technology, rugged endurance, and sleek design, the M5 continues the REESE Legacy of Pioneering Performance.

- 20,000 lb. capacity / 5,000 lb. pin weight capacity; 27,000 lb. capacity / 6,750 lb. pin weight capacity
- 14" to 18" vertical adjustment
- Offset center section - for additional clearance between cab and trailer
- Easy hook-up - clear Tow/No Tow indicator
- SAE J2638 Compliant
- Will not fit trucks with beds shorter than 6' in length unless used with a REESE Sidewinder™
- **Will not fit Flareside/Stepside**

Application	Description	20,000 lb	27,000 lb	32,000 lb
COMPLETE HITCH				
FORD	F250/F350 SD 11-22 w/Factory HD Towing Option Vehicle must be Equipped with Fifth Wheel Prep Kit	ULTR30921		ULTR30940
GM	Silverado/Sierra 2500/3500 HD 20-22 OEM Prep Kit. With factory HD Towing Option GM.	ULTR30938		
GM	Silverado/Sierra 2500/3500 HD 16-19 OEM Prep Kit. With factory HD Towing Option GM.	ULTR30890	ULTR30895	
RAM	2500/3500 14-22 Vehicle must be Equipped with Fifth Wheel Prep Kit	ULTR30918	ULTR30919	
UNIVERSAL	R30035 or R30153	ULTR30928	ULTR30929	
MODULAR COMPONENTS				
FORD	Center Section	ULTR30884	ULTR30894	
	Head Assembly	ULTR30892	ULTR30892	
	Legs	ULTR30923	ULTR30923	
GM	Center Section	ULTR30884	ULTR30894	
	Head Assembly	ULTR30892	ULTR30892	
	Legs	ULTR30889	ULTR30889	
RAM	Center Section	ULTR30884	ULTR30894	
	Head Assembly	ULTR30892	ULTR30892	
	Legs	ULTR30917	ULT	
ISR	Center Section	ULTR30884	ULTR30894	
	Head Assembly	ULTR30892	ULTR30892	

• ELITE SERIES •
• UNDER BED INSTALLATION •

5TH WHEEL WITHOUT RAILS HITCHES



ULTR30160

20,000 - 5,000 lb

- 4 way head pivot
- Adjustable height: 14" to 16 1/2"
- Kingpin indicator
- Wider 9" (vs 6") kingpin funnel area
- Includes 90° Fifth Wheel adapter Harness #5097410
- Pre-assembled - RAM EOM/OEM

RAIL KITS FOR 5TH WHEEL & GOOSENECK

ELITE SERIES



CHEVROLET / GMC		
11-19	Silverado / Sierra 2500 / 3500 HD except with OEM Towing Prep pkg	ULTR30868
DODGE / RAM		
03-09	Ram 1500 / 2500 / 3500	ULTR30074
2013	Ram 2500	ULTR30074
10-12	Ram 2500 / 3500	ULTR30074
FORD		
11-16	F250 / 350 / 450 SD not Cab and Chassis	ULTR30126
17-22	F250 / 350 / 450 SD except Factory Prep kit	ULTR30180

5TH WHEEL REPLACEMENT PARTS



REESE

ULTR30182

Mounting rail accessory kit for ULTR30180

UNIVERSAL INSTALLATION KITS



ULTR30035

Rail and installation kit (10 bolts)

ULTR58058

Rail only (10 bolts)

HEAVY DUTY RAIL KIT



ULTR30153

Heavy duty mounting rail kit, includes grade 8 hardware, 48" rails for faster installation.

REPLACEMENT PARTS

INSTALLATION KIT



ULTR30439
Installation kit only (ULTR30035)

KNURL BOLT



ULTR55055
1/2" - 13 x 1 1/2"
Sold per unit

REINSTALLATION KITS Without Mounting Brackets

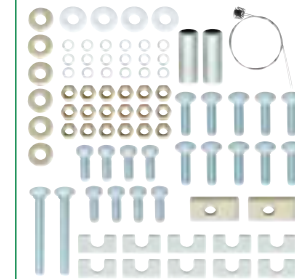

ULTR58164
For
ULTR30035 & ULTR58058

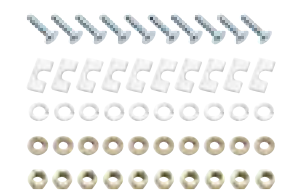

ULTR58430
For
ULTR58058

BRACKETS KITS

CUSTOM QUICK INSTALL KITS



CHEVROLET / GMC

01-07	Silverado/Sierra 1500 HD (Classic)	ULTR50064-58
99-19	Silverado/Sierra 1500 LD ¹ (old body style)	ULTR50064-58
99-04	Silverado/Sierra 2500	ULTR50064-58
01-10	Silverado/Sierra 2500 HD	ULTR50064-58
01-07	Silverado/Sierra 3500 (Classic)	ULTR50064-58
07-10	Silverado/Sierra 3500 HD	ULTR50064-58
11-19	Silverado/Sierra 2500/3500 HD	ULTR50066-58

DODGE / RAM

09-19	Ram 1500	ULTR50142-58
14-18	Ram 2500	ULTR50054-58
FORD		
04-14	F150	ULTR50081-58
15-20	F150 (exc. Raptor)	ULTR50087-58
17-22	F250/350 SD (exc. Dual Rear Wheel or Cab & Chassis)	ULTR50074-58
99-10	F250/350 SD (exc. Cab & Chassis)	ULTR50082-58
08-10	F450 SD (exc. Cab & Chassis)	ULTR50082-58

Kit includes hardware, custom fit brackets and rails

1: Doesn't fit Magneride Suspension • 2: Except with OEM HD Towing Prep Package

CUSTOM QUICK INSTALL BRACKETS



CHEVROLET / GMC

01-07	Silverado/Sierra 1500 HD (Classic)	ULTR50064
99-19	Silverado/Sierra 1500 LD ¹ old body style	ULTR50064
99-04	Silverado/Sierra 2500	ULTR50064
01-10	Silverado/Sierra 2500 HD	ULTR50064
01-07	Silverado/Sierra 3500 (Classic)	ULTR50064
07-10	Silverado/Sierra 3500 HD	ULTR50064
11-19	Silverado/Sierra 2500/3500 HD	ULTR50066

DODGE / RAM

09-19	Ram 1500	ULTR50142
02-08	Ram 1500 not Mega cab	ULTR50040
06-08	Ram 1500 Mega Cab	ULTR50140
03-12	Ram 2500/3500 not Mega Cab & with overload springs	ULTR50040

DODGE / RAM (CONT.)

03-09	Ram 2500/3500	ULTR50140
10-12	Ram 2500/3500 not w/gas engine with overload springs	ULTR50140
00-22	Ram 3500	ULTR50085
FORD		
04-14	F150	ULTR50081
15-20	F150 (except Raptor)	ULTR50087
99-10	F250/350 SD not Cab & Chassis	ULTR50082
11-16	F250/350/450 SD	ULTR50026
17-22	F250/350 SD (not Dual Rear Wheel or Cab & Chassis). Simple wheels	ULTR50074
08-10	F450 SD not Cab & Chassis	ULTR50082

ADAPTER BRACKETS FOR RAILS



DODGE / RAM

02-08	Ram 1500	ULTR58023
09-15	Ram 1500	ULTR58386
13-18	Ram 1500 not with Air Suspension or w/ECODiesel Engine	ULTR58386
13-19	Ram 1500 Classic, Except w/Air Suspension or w/ECODiesel Engine	ULTR58386
14-18	Ram 1500 (Except w/Air Suspension)	ULTR58523
14-19	Ram 1500 (Classic, Except w/Air Suspension)	ULTR58523
03-13	Ram 2500 (Except w/Overload Springs)	ULTR58023

DODGE / RAM (CONT.)

14-22	Ram 2500	ULTR58522
03-12	Ram 2500/3500 HD (w/ overload spring)	ULTR58186
03-12	Ram 3500 (Except w/Overload Springs)	ULTR58023
13-22	Ram 3500	ULTR58520
FORD		
04-14	F150	ULTR58426
15-20	F-150 (Except Raptor)	ULTR58531
NISSAN		
04-15	Titan	ULTR58405

• HEAVY DUTY INSTALLATION KITS •

BRACKET KITS OR RAIL AND SUPPORT KITS

KIT INCLUDES **HEAVY DUTY RAILS**

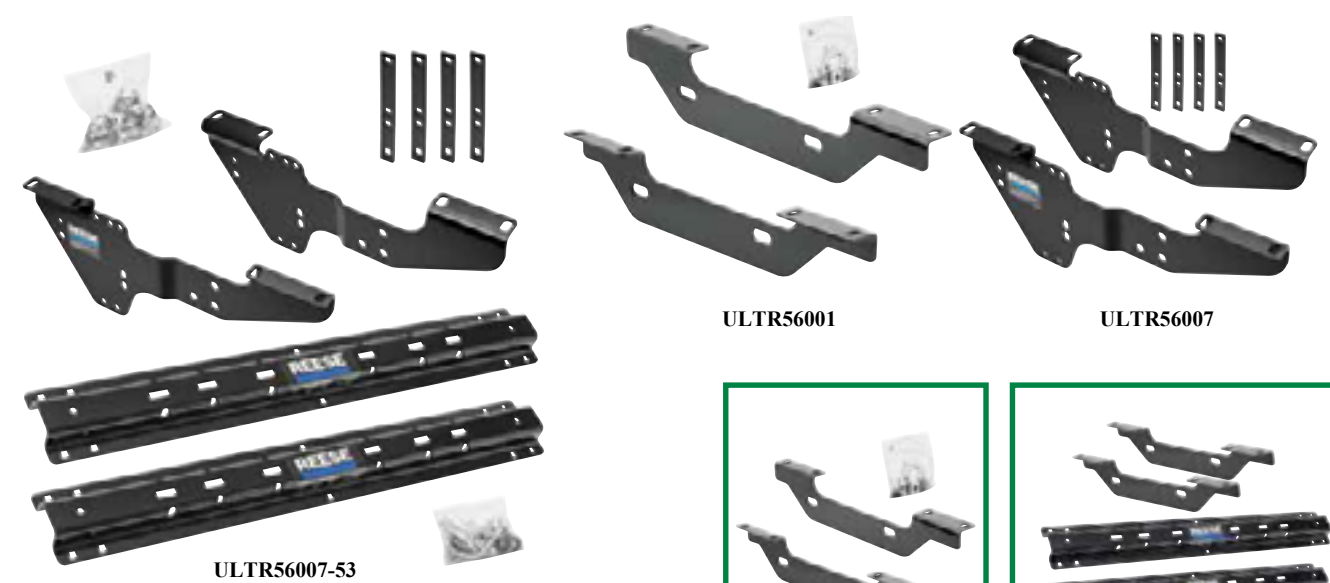

ULTR56001

ULTR56007

ULTR56007-53



BRACKET KITS



RAIL AND SUPPORT KITS

CHEVROLET / GMC		
11-14 Silverado/Sierra 2500/3500 HD All Style	ULTR56001	ULTR56001-53
15-19 Silverado/Sierra 2500/3500 HD (Except w/ OEM HD Towing Prep Pkg)	ULTR56001	ULTR56001-53
99-13 Silverado/Sierra1500	ULTR56007	ULTR56007-53
14-19 Silverado/Sierra 1500 LD (Old Body Style) Does Not Fit MagneRide Magnetic Ride Suspension)	ULTR56007	ULTR56007-53
19-22 Silverado/Sierra 1500 (New Body Style, Except 8' Bed & Models w/Adaptive Ride Control)	ULTR56015	---
01-10 Silverado/Sierra 2500/3500	ULTR56007	ULTR56007-53
20-22 Silverado 2500/3500 HD	ULTR56023	---
20-21 Sierra 2500/3500 HD (Except with Carbon Pro Bed)	ULTR56023	---
DODGE / RAM		
19-22 Ram 1500 (New Body Style, Except with Split Tail Gate)	ULTR56018	ULTR56018-53
14-22 Ram 2500	ULTR56009	---
FORD		
15-20 F-150 (Except Raptor)	ULTR56034	---
11-16 F-250/350/450 SD (Except Cab & Chassis)	ULTR56016	ULTR56016-53
17-22 F-250/350/450 SD (Except Cab & Chassis)	ULTR56017	ULTR56017-53



LUBE PLATES



ULTR83002
10" dia.
For: Select & Pro Series™

ULTR83001
12" dia.
For: Elite & Select plus™

ULTR83001
12" dia.
For: Elite & Select plus™

ULTR23-9150
10" dia.

ULTR23-9160
10" dia.

ULTR23-9152
12" dia.

PINS & CLIPS FOR 5TH WHEEL HITCH



ULTR58053
Pack of 4



ULTR58467
Pack of 4

LOCK FOR 5TH WHEEL



ULTD63254
1/2" lock

WIRE LOOMS FOR FISHWIRING FASTENERS

Pack of: 20



ULTD5481 7/16" 1/2"

5TH WHEELS REPLACEMENT PARTS



ULTR107022120
Fifth wheel bolt
1/2" x 3" GR5



ULTR30727
(Fifth Wheel Legs (2) 15K, 16K & 20K



ULTR58089
Replacement bumper rubbers for R30047



ULTR30776
Spring

ADAPTER KIT



ULTR58419
Adapts older style Signature Series hitches to work with new Elite™ Series rails

REPLACEMENTHANDLE



ULTR58553
M5 Fifth wheel replacement handle



ULTR58276
Wrench for Signature Series



ULTR58515
Pivot Beam Isolators with Mounting Hardware 16K

REPLACEMENTHANDLE



ULTRVXA3130
Lifting device for Companion & Patriot hitches



• PATRIOT SERIES •

5TH WHEEL HITCHES
Rails sold separately

- 16" - 19" vertical adjustment
- Double pivot automatic locking head with spring cushioning

- Fully articulating head
- 4 position adjustable uprights
- Above bed mounting system

- Grey powder coat finish
- 10 bolt install kit **ULTRVR3200** sold separately or **ULTR30035** and custom install brackets



ULTRVK3200
16,000 - 4,000 lb



ULTRVK3255
18,000 - 4,500 lb



ULTRVK3270
18,000 - 4,500 lb

Rails sold separately

- 17" - 19" vertical adjustment
- Double pivot automatic locking head with spring cushioning
- Fully articulating head
- 12" of slide
- 4 position adjustable uprights
- Above bed mounting system
- Grey powder coat finish
- 10 bolt install kit **ULTRVR3200** sold separately or **ULTR30035** and custom install brackets

• COMPANION SERIES • OEM PREPKIT

5TH WHEEL HITCHES



ULTRVK3300
Ford
OEM PREPKIT

- 16 3/4" - 18 3/4" vertical adjustment
- Cam action lever. It easy to hook and unhook the trailer
- Double locking jaws are 1 1/8" thick
- Side to side swivel motion is controlled with a gas charged shock absorber allowing 7° of controlled pivot action

ULTRVK3305
Ford
OEM PREPKIT

ULTRVK3700
GMC
OEM PREPKIT
20,000 - 5,000 lb

ULTRVK3710
GMC 20-21
OEM PREPKIT
20,000 - 5,000 lb

ULTRVK3715
GMC 20-21
OEM PREPKIT
25,000 - 6,250 lb

- Front to back pivoting saddle rides on polyurethane bushings which eliminate vibration and noise.
- Easy adjustment of height and lateral positions
- Works with Under Bed Mount for **Ford** F-Series and **GMC** trucks Prep Pkg



ULTRVK3370
FORD • OEM PREPKIT
20,000 - 5,000 lb

- 17"- 19" vertical adjustment
- Double pivot head
- Cam action lever. It easy to hook and unhook the trailer
- Double locking jaws are 1" thick
- Front to back pivoting saddle rides on polyurethane bushings which eliminate vibration and noise.
- Up to 8" travel

ULTRVK3670
RAM • OEM PREPKIT
20,000 - 5,000 lb

ULTRVK3775
GMC 20-21 • OEM PREPKIT
20,000 - 5,000 lb

5TH WHEEL HITCHES

• COMPANION SERIES • OEM PREPKIT



ULTRVK3600
RAM • OEM PREPKIT
25,000 - 6,250 lb

- 17" - 19" vertical adjustment
- Cam action lever. It easy to hook and unhook the trailer
- Double locking jaws are 1 1/8" thick
- Side to side swivel motion is controlled with a gas charged shock absorber allowing 7° of controlled pivot action
- Front to back pivoting saddle rides on polyurethane bushings which eliminate vibration and noise.
- Easy adjustment of height and lateral positions
- Works with Under Bed Mount for Ram trucks Prep Pkg



ULTRVK3770
GM • OEM PREPKIT
20,000 - 5,000 lb

- 17" - 19" vertical adjustment
- 12" of slide, so you can have the extra room to maneuver
- Fully articulating head allows front to back and side to side pivoting.
- 2" of front to back adjustment with three coupler positions.
- Cam action latching handle for easy release, even when parked on unlevel sites.
- 1" thick, wrap-around jaws fit kingpin perfectly, eliminating sloppy starts and stops.

• COMPANION SERIES • TURNOVERBALL



ULTRVK3500
GM • OEM PREPKIT
20,000 - 5,000 lb

- 16 1/4" - 18 1/4" vertical adjustment
- Rails ride on 1/4" non marring pads to protect the bed
- Pull only 1 pin and the hitch removes completely from the bed
- Cam action lever. It easy to hook and unhook the trailer
- Double locking jaws are 1 1/8" thick
- Side to side swivel motion is controlled with a gas charged shock absorber allowing 7° of controlled pivot action
- Front to back pivoting saddle rides on polyurethane bushings which eliminate vibration and noise.
- Easy adjustment of height and lateral positions
- Turnoverball install kit sold separately



ULTRVK3050
22,000 - 5,500 lb

- 14 3/4" - 16 3/4" vertical adjustment
- Designed for use on steel flatbeds only
- Cam action lever makes it easy to hook and unhook the trailer
- Double locking jaws are 1 1/8" thick
- Front to back pivoting saddle rides on polyurethane bushings which eliminate vibration and noise.
- Easy adjustment of height and lateral positions
- Ability to sit in a 20" x 20" well, up to 4" deep
- Turnoverball install kit sold separately



ULTRVK3405
20,000 - 5,000 lb

- 17" - 19" vertical adjustment
- 12" of slide (not for use on beds shorter than 6')
- Rails ride on 1/4" non marring pads to protect the bed
- Pull only 1 pin and the hitch removes completely from the bed
- Cam action lever. It easy to hook and unhook the trailer
- Double locking jaws are 1 1/8" thick
- Side to side swivel motion is controlled with a gas charged shock absorber allowing 7° of controlled pivot action
- Front to back pivoting saddle rides on polyurethane bushings which eliminate vibration and noise.
- Easy adjustment of height and lateral positions
- Turnoverball install kit sold separately



MOUNTING BRACKETS



ULTRVR2504
CHEVROLET / GMC
Silverado/Sierra 1500 19-21 not 2019 Old Body
Except w/ Carbon Pro Bed



ULTRVR2506
CHEVROLET / GMC
Silverado/Sierra 2500/3500 11-19



ULTRVK2505
CHEVROLET / GMC
Silverado/Sierra 2500/3500 20-21
exc. Trucks w/ CarbonPro Bed



ULTRVK2405
FORD
F150 15-21

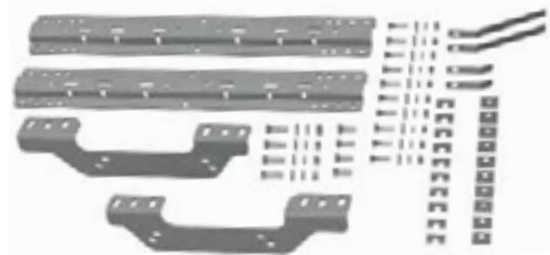

ULTRVK2506
CHEVROLET / GMC
Silverado/Sierra 2500/3500 11-19

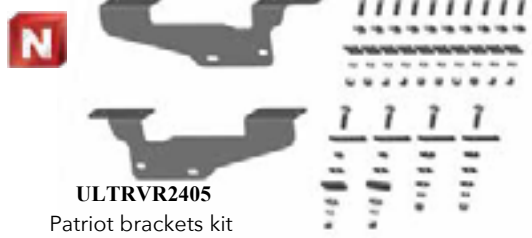

ULTRVR2405
Patriot brackets kit
FORD
F150 15-20



ULTRVR2402
FORD
F250/350 17-21



ULTRVK2402
FORD
F250 / F300 17-21

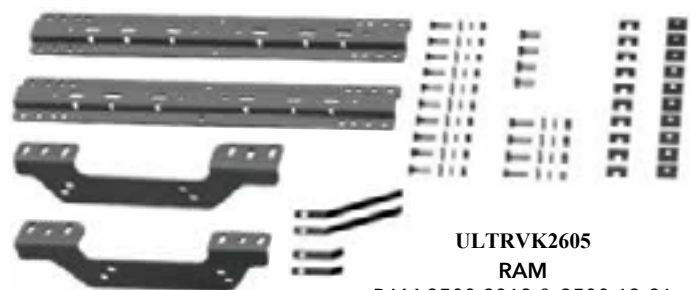

ULTRVK2605
RAM
RAM 2500 2013 & 3500 13-21

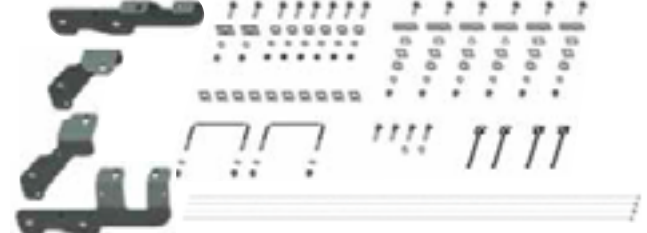

ULTRVR2604
RAM
RAM 1500 19-21 not Classic & TRX



**5TH WHEEL HITCHES
UNDER BED MOUNT**



Autoslide

- Short Box Application
- Slides utilizing rack and pinion gear technology
- Three vertical height adjustments to help you level the truck and trailer
- Powder coated for long lasting, durable finish
- Up to 14" of travel
- Double pivot head with 3/4" solid steel, positive locking slide bar

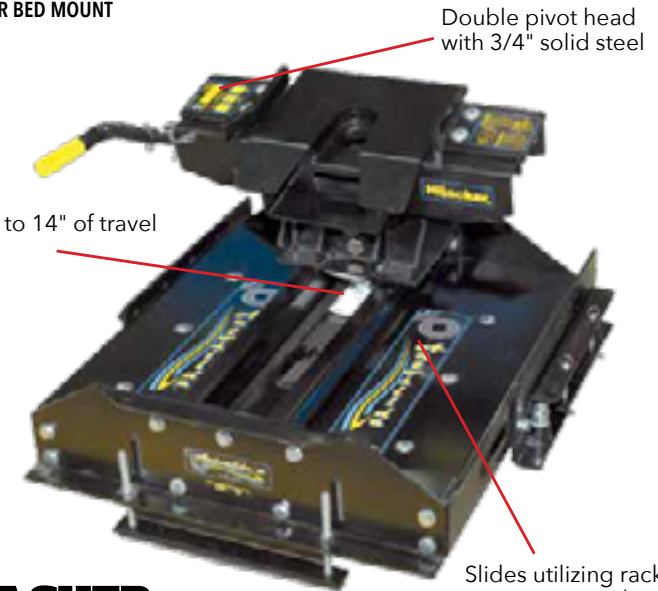

Double pivot head with 3/4" solid steel

Up to 14" of travel

Slides utilizing rack and pinion gear technology

HJACKER



ULTHJ8550024
18,000 lb
For: FORD

Bed rails included. Frame mounting brackets must be ordered separately.



ULTHJ8550023
18,000 lb • ULTRA Series
Above bed mount

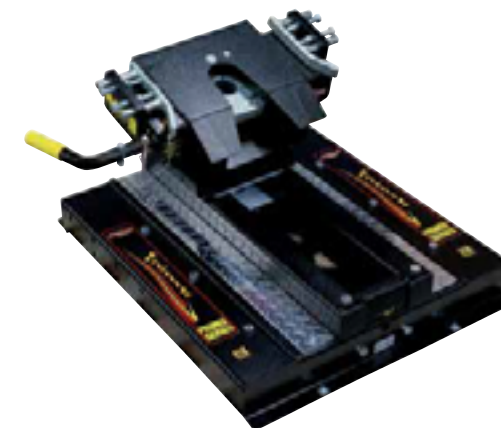

ULTHJ8550038
21,000 lb

Autoslide UMS
Ford Prep Pkg

DEMCO

Made in USA

**HIJACKER
SL SERIES**

5TH WHEEL HITCHES

- Long/Short box application
- **Double pivot head**
- Bed rail included
- Unique Jaw adjustment bolt that reduces noise and play
- Four vertical height adjustments to help you level the truck and trailer

ULTHJ8550029
16,000 lb



ULTHJ8550030
21,000 lb



ULTDE8550042
21,000 lb

- Flat Deck
- Long/Short box application
- **Double pivot head**
- Bed rail included
- Unique Jaw adjustment bolt that reduces noise and play
- Four vertical height adjustments to help you level the truck and trailer



UMS SERIES
ULTDM8550050
CHEVROLET / GMC 2020 • 21,000 lb

- **Double pivot head.**
- Wrap around jaw with locking bar.
- Long box applications only. Powder coated.

**HIJACKER
AUTOSLIDE 13K**



ULTDE8550036
21,000 - 5,000 lb

3 vertical height adjustments.
14" of slide utilizing rack and pinion gear technology.
Jaw with locking bar. Includes rails: D6071.



FOR 5.5' OR 6' TRUCK BEDS
ULTDM8550047
13K with Standard Bed Rails Included

DEMCO

HIJACKER PREMIER SERIES



ULTHJ8550026
16,000 lb

- Short box application
- **Double pivot head** with polyurethane bumpers
- Bed rail included
- Unique Jaw adjustment bolt that reduces noise and play
- 3/4" solid steel, positive locking slide bar for easy and secure hook-up
- Four vertical height adjustments to help you level the truck and trailer
- Stainless steel rollers
- Up to 8" of travel
- Frame mounting brackets must be ordered separately



ULTHJ8550025
16,000 lb

- Long box application
- **Double pivot head** with polyurethane bumpers
- Bed rail included
- Unique Jaw adjustment bolt that reduces noise and play
- 3/4" solid steel, positive locking slide bar for easy and secure hook-up
- Four vertical height adjustments to help you level the truck and trailer

ACCESSORIES



ULTD14844
Hijacker cover



ULTDE6025
Capture plates:
MOR / RYDE

HIJACKER PREMIER SERIES

Made in USA



ULTHJ8550027
21,000 lb

- Long box application
- **Double pivot head** with polyurethane bumpers
- Bed rail included
- Unique Jaw adjustment bolt that reduces noise and play
- 3/4" solid steel, positive locking slide bar for easy and secure hook-up
- Four vertical height adjustments to help you level the truck and trailer

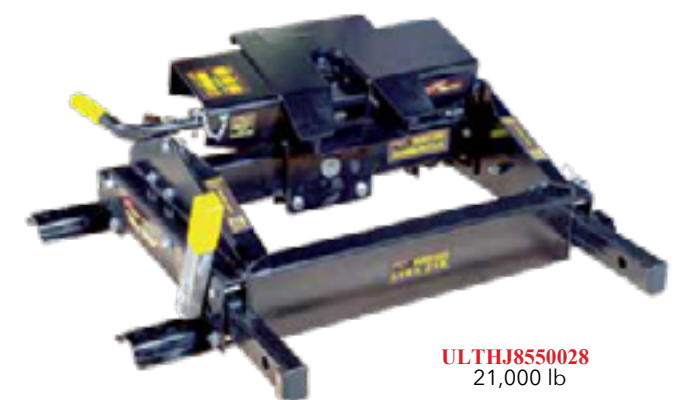

ULTHJ8550028
21,000 lb

- Short box application
- **Double pivot head** with polyurethane bumpers
- Bed rail included
- Unique Jaw adjustment bolt that reduces noise and play
- 3/4" solid steel, positive locking slide bar for easy and secure hook-up
- Four vertical height adjustments to help you level the truck and trailer
- Stainless steel rollers
- Up to 8" of travel
- Frame mounting brackets must be ordered separately

DEMCO

RECON

5TH WHEEL HITCHES



- Latch handle built in - No additional levers or rods needed to hook or unhook
- Fits Industry Standard Rails (ISR)
- 14" of rearward travel
- Utilizing an aerodynamic standard 5th wheel head

- Lighter weight, two-piece design for easy install and removal in and out of your truck
- Wrap around jaw with lock bar for a stronger, more secure, safer towing experience
- Dual articulation head for easy hookup and release on uneven terrain
- 3 height adjustments from 16 7/8", 18 1/8", and 19 3/8" for level towing



ULTDM8550053
21k Recon slider 5th wheel hitch with rails



ULTDM8550052
21k Recon slider 5th wheel hitch without rails

- Latch handle built in - No additional levers or rods needed to hook or unhook
- Fits Industry Standard Rails (ISR)
- Utilizing an aerodynamic standard 5th wheel head
- Lighter weight, two-piece design for easy install and removal in and out of your truck

- Wrap around jaw with lock bar for a stronger, more secure, safer towing experience
- Dual articulation head for easy hookup and release on uneven terrain
- 3 height adjustments from 15-1/2" to 18" for level towing



ULTHJ8550044
21k Recon double pivot 5th wheel hitch with standard bedrails



ULTHJ8550043
21k Recon double pivot 5th wheel hitch WITHOUTTrails

5TH WHEEL HITCH FOR GOOSENECK BALL MOUNT



ULTHJ8550045
21,000 lb

- Dual articulation head
- Wrap around jaw with lock bar for stronger
- Lighter weight, two piece design for easy install and removal
- 3 height adjustments 15 1/2" to 18"

DEMCO

RECON 5TH WHEEL HITCHES

ULTHJ8550046

21k recon flat deck gooseneck-to-5th wheel trailer hitch adapter for recessed ball - single jaw



- Fits standard 4" tall, 2-5/16" Recessed Gooseneck Ball Mount (Goose Neck Ball Mount must be rated at least 21K) - 8550046
- 3 vertical height adjustments: 11 1/2', 12 3/4' and 14"
- Latch handle built in - no additional levers or rods needed to hook or unhook
- Lighter weight, two piece design for easy install and removal
- Wrap around jaw with lock bar for stronger, more secure, safer towing experience
- Dual articulation head for easy hookup and release on uneven terrain
- 21,000 lb towing capacity
- Made In America

UPGRADE KITS



ULTD6078
Upgrade single pivot UL or SL to double pivot



ULTD6076
Upgrade single pivot SL, UMS or Premier to double pivot



ULTD6051
Upgrade the ULTHJ8550025 to 21K towing capacity for Premier Series stationary hitch



ULTD6052
Upgrade the 8550019 or the 8550026 to 21K towing capacity

ULT24-6020
Upgrade the 8550008, 8550009 or the 8550029 to 21K towing capacity

FRAME MOUNTING BRACKET KITS

		UMS Series Under Bed mount	PREMIER Series	SL Series
CHEVROLET / GMC				
19-20	Silverado 1500 LD & GMC Sierra Limited Double Cab 6.5' Bed	---	ULTHJ8552027	ULTHJ8553014
14-18	Silverado/Sierra 1500 (5.5', 6.5' & 8') Regular, Double, and Crew Cab	---	ULTHJ8552027	ULTHJ8553014
19-21	Silverado/Sierra 1500 Crew Cab 5.5', 6.5' and 8'	ULTDM8551011	---	ULTDM8553019
99-07	Silverado/Sierra 1500 (6.5' & 8' Boxes)	---	ULTHJ8552009	ULTHJ8553004
01-07	Silverado/Sierra 1500 HD (6.5' & 8' Boxes)	---	ULTHJ8552009	ULTHJ8553004
07-13	Silverado/Sierra 1500 (6.5' and 8' Box) (tube frame)	---	ULTHJ8552009	ULTHJ8553004
14-19	Silverado/Sierra 1500 (6.5') Double Cab , Old Body	---	ULTHJ8552027	ULTHJ8553014
04-13	Silverado/Sierra 1500 (5.8') Old Body	---	ULTHJ8552009	ULTHJ8553004
14-19	Silverado/Sierra 1500 (5.8') Old Body	---	ULTHJ8552027	ULTHJ8553014
04-06	Silverado/Sierra 1500 (5.5')	---	ULTHJ8552009	ULTHJ8553004
88-98	Silverado/Sierra 1500 (8' Box)	---	ULTHJ8552009	---
88-98	Silverado/Sierra 1500 (6.5')	---	ULTHJ8552009	---
07-13	Silverado/Sierra 1500 (5.5')	---	ULTHJ8552009	ULTHJ8553004
88-98	Silverado/Sierra 2500 (8')	---	ULTHJ8552009	---
88-98	Silverado/Sierra 2500 (6.5')	---	ULTHJ8552009	---
99-07	Silverado/Sierra 2500 (6.5' & 8')	---	ULTHJ8552009	ULTHJ8553004
88-01	Silverado/Sierra 3500 (6.5' and 8')	---	ULTHJ8552009	---
20-21	Silverado/Sierra 2500/3500 HD (6.5')	ULTDM8551012	ULTDM8552037	ULTDM8553020
20-21	Silverado/Sierra 2500/3500 HD (8')	ULTDM8551012	---	ULTDM8553020
11-18	Silverado/Sierra 2500/3500 HD (6.5')	---	ULTHJ8552011**	ULTHJ8553007**
11-18	Silverado/Sierra 2500/3500 HD (8')	ULTHJ8551003	ULTHJ8552011**	ULTHJ8553007**
11-19	Silverado/Sierra 2500/3500 HD (6.5' & 8')	---	ULTHJ8552011**	ULTHJ8553007**
01-10	Silverado/Sierra 2500/3500 HD (6.5' & 8') (Includes New Body Style)	---	ULTHJ8552009	ULTHJ8553004

* Not with "Auto Level Rear Air Suspension" option

** No drill attachment

FRAME MOUNTING BRACKET KITS

		UMS Series Under Bed mount	PREMIER Series	SL Series
DODGE / RAM				
19-20	Ram 1500 Classic (5.5', 6.5' & 8') No Air Suspension Incl. Diesel	---	ULTHJ8552030	ULT24-6123
19-21	Ram 1500 (5.5', 6.5' & 8') No Air Suspension Incl. Diesel	---	ULTDM8552032	ULTDM8553018
09-18	Ram 1500 (5.5', 6.5' & 8') No Air Suspension Incl. Diesel	---	ULTHJ8552030	ULT24-6123
02-08	Ram 1500 (4x2 & 4x4)(6.5' & 8')(Incl. Mega Cab)	---	ULTHJ8552015	ULTHJ8553004
94-01	Ram 1500	---	ULTHJ8552009	--
94-02	Ram 2500 (6.5' & 8')	---	ULTHJ8552009	--
94-02	Ram 3500 (6.5' & 8')	---	ULTHJ8552009	--
14-20	Ram 2500 (4x2 & 4x4)(6.5' & 8') (Incl. Mega Cab, Auto Level Rear Air Suspension)	---	ULTHJ8552025**	ULTHJ8553016
03-12	Ram 2500 (4x2 & 4x4)(6.5' & 8') (Incl. Mega Cab)	---	ULTHJ8552015	ULTHJ8553004
2013	Ram 2500 (4x2 & 4x4)(6.5' & 8') (Incl. Mega Cab)	---	ULTHJ8552015	ULTHJ8553004
-93	Ram (6.5' & 8')	---	ULTHJ8552009	---
-02	Dakota	---	ULTHJ8552009	---
03-04	Dakota (6.5')	---	ULTHJ8552009	---
19-20	Ram 3500 (4x2 & 4x4)(6.5' & 8') (Incl. Mega Cab)	---	---	ULTHJ8553013*
13-18	Ram 3500 (4x2 & 4x4)(6.5' & 8') (Incl. Mega Cab)	---	ULTHJ8552026**	ULTHJ8553013*
03-12	Ram 3500 (4x4 only)(6.5' & 8') (Incl. Mega Cab)	---	ULTHJ8552015	ULTHJ8553004
03-12	Ram 3500 (4x2 only)(6.5' & 8') (Incl. Mega Cab)	---	---	ULTHJ8553004
FORD				
97-03	F150 (6.5' & 8')	---	ULTHJ8552009	ULTHJ8553004
04-14	F150 (5.5', 6.5' & 8')	---	ULTHJ8552003	ULTHJ8553002
15-20	F150 (5.5', 6.5' & 8')	---	ULTHJ8552028	ULTHJ8553015
97-03	F250 "Light Duty" (6.5' & 8')	---	ULTHJ8552009	ULTHJ8553004
05-10	F250/350 "Super Duty"	---	ULTHJ8552001	ULTHJ8553001
11-16	F250/350 "Super Duty" (6.5' & 8')	---	ULTHJ8552000**	ULTHJ8553000**
17-20	F250/350 "Super Duty" (6.5' & 8')	---	ULTHJ8552031**	ULTHJ8553017**
08-10	F450 "Super Duty"	---	ULTHJ8552001	ULTHJ8553001
11-16	F450 "Super Duty"	---	ULTHJ8552000**	ULTHJ8553000**
17-20	F450 "Super Duty"	---	ULTHJ8552031	ULTHJ8553017**
TOYOTA				
07-20	Tundra (5.5', 6.5' & 8')	---	ULTHJ8552020	---
01-06	Tundra (6.5' & 8')	---	ULTHJ8552009	Not recommended
-00	T100	---	ULTHJ8552009	---

* Not with "Auto Level Rear Air Suspension" option

** No drill attachment

5TH WHEEL ADAPTER FOR WITH FACTORY INSTALLED 5TH WHEEL HITCH PACKAGE



DM633
Cap.: 21,000 lb
CHEVROLET / GMC
Silverado/Sierra 2020
2500 & 3500 (6.5' & 8')



DE6175
Cap.: 25,000 lb
FORD



D6099
Cap.: 25,000 lb
RAM



DE6194
Cap.: 21,000 lb
CHEVROLET / GMC 6.5'

DE6206
Cap.: 21,000 lb
CHEVROLET / GMC 8'

D6200
Cap.: 21,000 lb
NISSAN Titan XD

BED RAILS



ULTD6071
Fits Premier series



ULTD6040
Fits Ultra series

ULT24-60
10 Fits
SL series

REPLACEMENT PARTS



ULTR23-6013
Side rails for
SL series 5th wheels

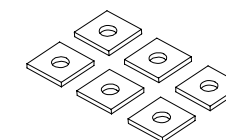

ULTR24-6058
SL series
5th wheels

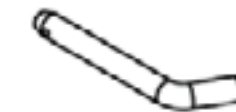

ULTR24-6095
Bed rail pull
pin



ULTRD6023
Premier series
pivot saddle bracket



ULTRPBG6014
Bolt bag



ULTRDE14193-76
1/2" bracket nut slides over bracket to
provide an attached nut for installs with
hard to reach places



ULTRDM15769
Urethane
bumper

5TH WHEEL SUPPORTS

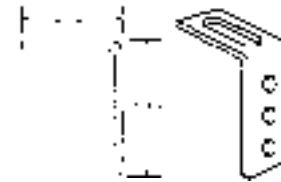

ULTR24-6100
Standard bracket

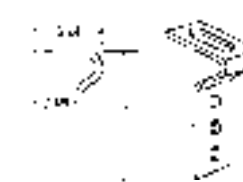

ULTR24-6101
Curved bracket



ULTR24-6102
Long bracket

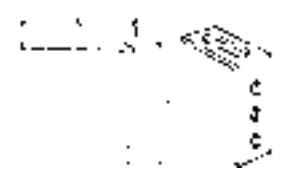

ULTR24-6103
Extra long bracket

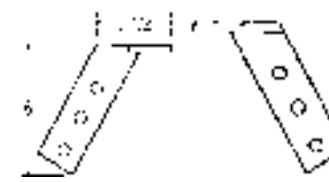

ULTR24-6105
Angled bracket - Left

ULTR24-6106
Angled bracket - Right



ULTR24-6108
Custom bracket - Left

ULTR24-6109
Custom bracket - Right



5TH WHEEL HITCH ACCESSORY



ULTRPR3513
24,000 lb
Conversion adapter from OE to Super Glide.
Works with Pullrite Super Glide 5th wheels
16,000 and 20,000 lb.

"SUPER GLIDE" RAILS

ULTPR4440
RAM
2500 2013
For 16 & 20 K

ULTPR3520
FORD
F250/350 Diesel 6.5' 99-15
For 24 K

REPLACEMENT PARTS

ULTR23-6040
UL401-IK
Ultra Bed Rail Kit

ULTR23-6012
24" Pivot
Saddle Bracket

5TH WHEEL RAIL KIT

ULTRVR3200
Grey finish. For Patriot 5th wheel hitch.

GOOSENECK HITCH HIDE-A-GOOSE

30,000 lb - 7,500 lb
Ball: 2 5/16"

ULTD9465-54 **ULTD9466**

	COMPLETE	RAILS
CHEVROLET / GMC		
99-19 Silverado/Sierra 1500 LD Old Body*	ULTD9465-54	---
DODGE / RAM		
14-18 Ram 2500	ULTD9467	---
13-18 Ram 3500	ULTD9466	---
FORD		
15-22 F150 not Raptor	ULTD9465-91	ULTR4491
99-16 F250/350 SD not Cab & Chassis	ULTD9460-49	---
17-22 F250/350/450 SD not Cab & Chassis	ULTD9468-94	ULTD4494
08-16 F450 SD not Cab & Chassis	ULTD9460-49	---

* Does not fit models equipped with MagneRide Magnetic Ride Suspension

GOOSENECK HITCH

Use with rail and installation kit **ULTR30035**, **ULTR30095** or **ULTR30153** sold separately

ULTD8339
25,000 - 6,250 lb
Fold-down gooseneck
hitch platform with 2 5/16" ball

ULTR58079
25,000 - 6,250 lb

ULTR49080
25,000 - 6,250 lb

GOOSENECK HITCH • ELITE SERIES 25,000 LB

REESE
ULTR30158-68
Complete Hitch
CHEVROLET / GMC
Silverado/Sierra 11-19
2500/3500 HD
6.5 & 8' bed,
2 & 4 WD

REESE
ULTR30845
ELITE 25K Series
25,000 lb / 7,500 lb

FOLD-DOWN GOOSENECK HITCH PLATFORM

DRAW TITE
ULTD6300
30,000 - 7,500 lb
Remov-A-Ball
gooseneck hitch
platform with
2 5/16" ball

U-Bolt not included

GOOSENECK HEAD WITH BOLTS AND 2 5/16" POP-IN BALL (WITHOUT RAILS)

REESE
ULTR30138
FORD
F250/350/450 SD will not fit Cab and Chassis

REPLACEMENT HEAD

DRAW TITE
ULTD9468
For: FORD

GOOSENECK HITCH ELITE SERIES • 25,000 LB

REESE

Accessories kit for ELITE - Underbed gooseneck hitch. Includes: 2 5/16" pop-in ball, storage bag, safety chain attachment and hole cover.

ULTR30137 For: OEM FORD / NISSAN **R30888** For: OEM RAM

POP-IN BALLS FOR ELITE

REESE
ULTR19311
2 5/16" for ELITE -
Underbed gooseneck Hitch

ULTD19315
2 5/16" for ELITE -
Underbed gooseneck Hitch
1" rise

SAFETY CHAIN ATTACHMENTS FOR ELITE UNDERBED GOOSENECK HITCH

REESE
ULTR30134
Sold per unit

ULTR58468
Sold in pairs

HITCH CHAIN BRACKET

REESE
ULTHH50223
Cap.: 18,000 lb

POP-IN BALL FOR GM GOOSENECK SYSTEM

REESE
ULTR30948

- Pop-In Ball-Lever inside ball head activates ball bearing locking system-Lift and turn lever to unlock and remove ball
- Two safety chain holders
- Hole cover keeps Pop-In Ball sleeve free of debris
- Storage bag included
- Ball rated for 30,000 lbs. capacity
- Fits GM OEM Kits with factory installed OE rail system only

2 5/16" BALL AND SAFETY CHAIN KIT

BW
ULTGXA2061
For: GMC /
Ford /
Nissan OEM

ULTGXA2062
For:
OEM RAM

TURNOVER BALL GOOSENECK HITCHES



CHEVROLET / GMC

19-20	1500 Crew Cab 5.8' (exc. Trucks w/ CarbonPro Bed) (NOT 2019 Old Body)	ULTGNRK1019-919
2019	1500 (Box Frame) 6.5' old body	ULTGNRK1057-959
07-18	1500 (Box Frame) 6.5'	ULTGNRK1057-959
2020	2500 / 3500 (exc. Trucks w/ CarbonPro Bed)	ULTGNRK1020
16-19	2500 / 3500 HD 6.5' & 8'	ULTGNRK1016-912
11-15	2500 HD 6.5' & 8'	ULTGNRK1012-912
00-10	2500 HD 6.5' & 8'	ULTGNRK1067-959
11-15	3500 6.5' & 8'	ULTGNRK1012-912
07-10	3500 HD (with 1 bed crossmember over the axle)	ULTGNRK1067-959
01-07	3500 HD Classic (w/ 2 bed crossmember over the axle)	ULTGNRK1062-962RN

DODGE / RAM

19-20	1500 Gas Engine (exc 1500 Classic)	ULTGNRK1319
2019	1500 DT Gas Engine	ULTGNRK1319-800
09-18	1500 All Beds (not compatible with Companion 5th wheel hitches)	ULTGNRK1309-909
06-12	1500 Mega Cab	ULTGNRK1308-907
94-01	1500	ULTGNRK1394-900
14-18	2500 6.5' & 8' with coil springs	ULTGNRK1384
10-13	2500 Diesel Engine	ULTGNRK1313-900
10-13	2500 8' Gas Engine	ULTGNRK1308-907
2013	2500 Gas Engine	ULTGNRK1308-907
2013	2500 Mega Cab	ULTGNRK1308-907
2019	2500/3500	ULTGNRK1320



2 5/16" ball

DODGE / RAM (cont.)

10-12	2500/3500 Gas Engine	ULTGNRK1308-907
06-12	2500/3500 Mega Cab	ULTGNRK1308-907
03-09	2500/3500	ULTGNRK1313-900
94-02	2500/3500	ULTGNRK1394-900
13-18	3500 6.5' & 8'	ULTGNRK1314
10-12	3500 8' Gas Engine	ULTGNRK1308-907
10-12	3500 Diesel Engine	ULTGNRK1313-900

FORD

2021	F150	ULTGNRK1121-900
04-14	F150	ULTGNRK1104-959N
17-20	F250/350	ULTGNRK1117-816
11-16	F250, F350 SD	ULTGNRK1111-800
99-10	F250, F350 SD	ULTGNRK1108-800
17-20	F450 (with factory installed bed)	ULTGNRK1117-816
11-16	F450 (with factory installed bed)	ULTGNRK1111-800
08-10	F450 (with factory installed bed)	ULTGNRK1108-800

NISSAN

17-18	Titan XD	ULTGNRK1217
-------	----------	--------------------

TOYOTA

07-20	Tundra (not compatible with Companion 5th wheel hitches)	ULTGNRK1257-1256
-------	--	-------------------------

UNIVERSAL FLAT BED

--	Flat bed kit 6" x 8" - 1/2" plate - 1/8" Socket top stick out	ULTGNRK1500
----	---	--------------------

REPLACEMENT PARTS



ULTGNXA4000
King Pin



ULTGNXA4085
4" extender



ULTGNXA2000
2 5/16" ball, 30,000 lb
(included with frame kits)



ULTGNXA2050
Hi-Rise ball
(20,000 lb)

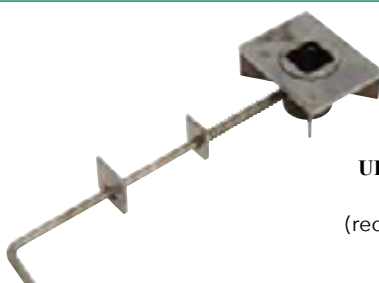

ULTGNRK1500
Flatbed kit
(requires welding)

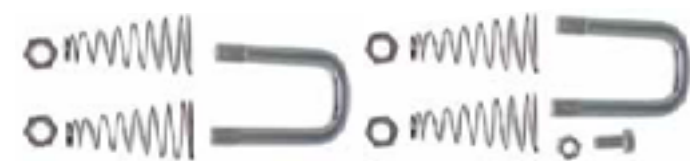

ULT1900-2-1600
Safety chain U-bolt kit
(included with frame kits)

**GOOSENECKS
HIJACKER
DEMCO**
5 year warranty

SL SERIES 25K



ULT24-6150
25,000 lb

- Long Box Application
- Works with existing SL rail system
- Removes easily by pulling four pins

- 2 5/16" ball
- Powder coated for long lasting, durable finish

Bed rails **not** included. Frame mounting brackets must be ordered separately.

PREMIER/ULTRA SERIES 25K

ULT24-6151
25,000 lb

- Long Box Application
- Works with existing UL rail system
- Removes easily by pulling four pins

- 2 5/16" ball
- Powder coated for long lasting, durable finish



SLIDER GOOSENECK HITCHES • 25K



Frame mounting brackets must be ordered separately.

ULTHJ8550011
25,000 lb

- Includes 2 5/16" chrome hitch ball
- Utilizes same rails as Slider fifth wheel hitches
- Bed rails & installation kit are included
- Premium corrosion resistant black finish
- Components are available separately

COMPLETE WEIGHT DISTRIBUTION KIT



Includes:
Sway control. Weight distributor.
Chains. Brackets. Ball 2 5/16".

ULT22-8210
10,000 - 600 lb

ULT22-8211
10,000 - 800 lb

ULT22-8212
10,000 - 1,000 lb

ULTR49911
6,000 - 600 lb

ULTR49912
8,000 - 800 lb

ULTR49913
11,500 - 1,150 lb

WEIGHT DISTRIBUTING KITS



ULT22-8200
10,000 - 600 lb

ULT22-8201
10,000 - 800 lb

ULT22-8202
10,000 - 1,000 lb

ROUND BARS

Shank not included



Adjusting washer. One piece cast head. Adjustable shank included.

REESE

ULTR67509
10,000 - 800 lb

**WEIGHT DISTRIBUTING KITS
"TRUNNION STYLE"**

Without weight distributing



With weight distributing



Weight distribution kit. Includes sway control - DUAL CAM™ II

REESE
N

ULTR66091 6,000 lb ULTR66092 8,000 lb ULTR66093 12,000 lb

Shank not included

ULTR22-8300 10,000 - 600 lb ULTR22-8301 10,000 - 800 lb ULTR22-8302 10,000 - 1,000 lb

Adjustable shank. Sold separately.

REESE

ULTR66022 12,000 - 1,200 lb

Weight distribution kit. Includes sway control.

REESE
STEADI-FLEX

ULTR66557 4,000 - 400 lb ULTD66559 10,000 - 1,000 lb ULTD66560 12,000 - 1,200 lb ULTD66561 14,000 - 1,400 lb

Weight distribution kit. Complete. High-performance.

REESE

ULTCE66540 6,000 - 600 lb ULTCE66542 12,000 - 1,200 lb

Weight distribution kit. Shank sold separately.

REESE

ULTD66131 15,000 - 1,500 lb

ADJUSTABLE SHANKS

RV
ULTR22-8142 10,000 - 1,000 lb Shank bar 12 holes
ULTR22-8138 10,000 - 1,000 lb Shank bar 8 holes
ULTR22-8116 10,000 - 1,000 lb Shank bar 6 holes
ULTR22-8140 10,000 - 1,000 lb Shank bar 10 holes

REESE
ULTR54998 16,000 - 1,600 lb Shank • 12 1/4" L Opening: 2" x 2"

DRAW-TITE
ULTD63971 15,000 - 1,500 lb Shank • 14" L Drop: 5 3/4" Opening: 2" x 2" Use in drop position only

HEAD ASSEMBLIES

REESE
ULTR58167 Standard 10,000 - 1,000 lb

REESE
ULTR58112 Round Bar High performance 12,000 - 1,200 lb

PRO
ULTD58333 Trunnion & RB2 10,000 - 1,000 lb

SPRING BAR RETAINER

RV
ULTR22-8117 Round Bar 10,000 - 1,000 lb

RV
ULTR22-8118 Spring bar retainer

HOOK-UP BRACKETS

REESE
ULTR21501 Sold per unit

RV
ULTR22-8135 Sold in pair

easy lift
ULTR22-4097 Sold per unit

REESE
ULTD6637 Bracket kit. Includes pin & lift handle

REPLACEMENT PARTS

REESE
ULTR55630 Replacement chain (Incl.: 1 chain, 2 Flat washers, 2 nuts and 1 "U" bolt).

easy lift
ULTR22-4298 Wire clips for hook-up brackets. Pack of 2.

easy lift
ULTR22-5001 Spring bar locking device kit (Contains two of each pins, retainers, and screws)

RV
ULTR22-8114 Snapper Pin 1/4" x 2 1/2"

REESE
ULTR55180 Safety pin for S nap-up bracket ULTR21501.

REESE
ULTR58029 Safety pin for Snap-up bracket (pair).

RV
ULTR22-8110 Pipe handle

REESE
ULTR58162 Pipe handle

TRAILER TONGUE WEIGHT SCALE

TOW-READY



ULTD5780
2,000 lb
Hydraulic pressure gauge

SWAY CONTROLS



ULT22-1999
Complete kit

REESE



ULTR83660
Complete kit. Can be used on left or right side of trailer

REPLACEMENT PARTS



RV Pro

ULT22-1709
Ball



DRAW-TITE

ULTD58060
Ball



CAMCO

ULT22-1719
Ball Tongue Plate

DUAL CAM HP WEIGHT DISTRIBUTION SWAY CONTROL



REESE

ULTR26002
Double Cam HP.

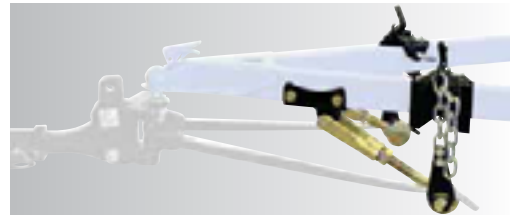

SWAY CONTROL ADAPTER BRACKETS

REESE



ULTR26005
For 1 1/4" x 1 1/4"
Ball mount and ball not included.

REESE



ULTR26003
For 2" x 2"
Ball mount and ball not included.

REESE



ULTD3442
Weld-on sway control adaptor

**ROUES POWDERCOAT NOIR LUSTRÉ
GLOSS BLACK POWDERCOAT WHEELS**



SERVICE
4
JOURS
DAYS

GARANTIE
10
ANS

Cueillette et livraison
gratuites disponibles
Free pickup & delivery
available



\$149
CHAQUE

DAN
(514) 592-0005

Ultracar Performance Inc. 1254 boul. Marcel-Laurin, Saint Laurent, Montréal, QC H4R 1J7
www.ultracar.com