

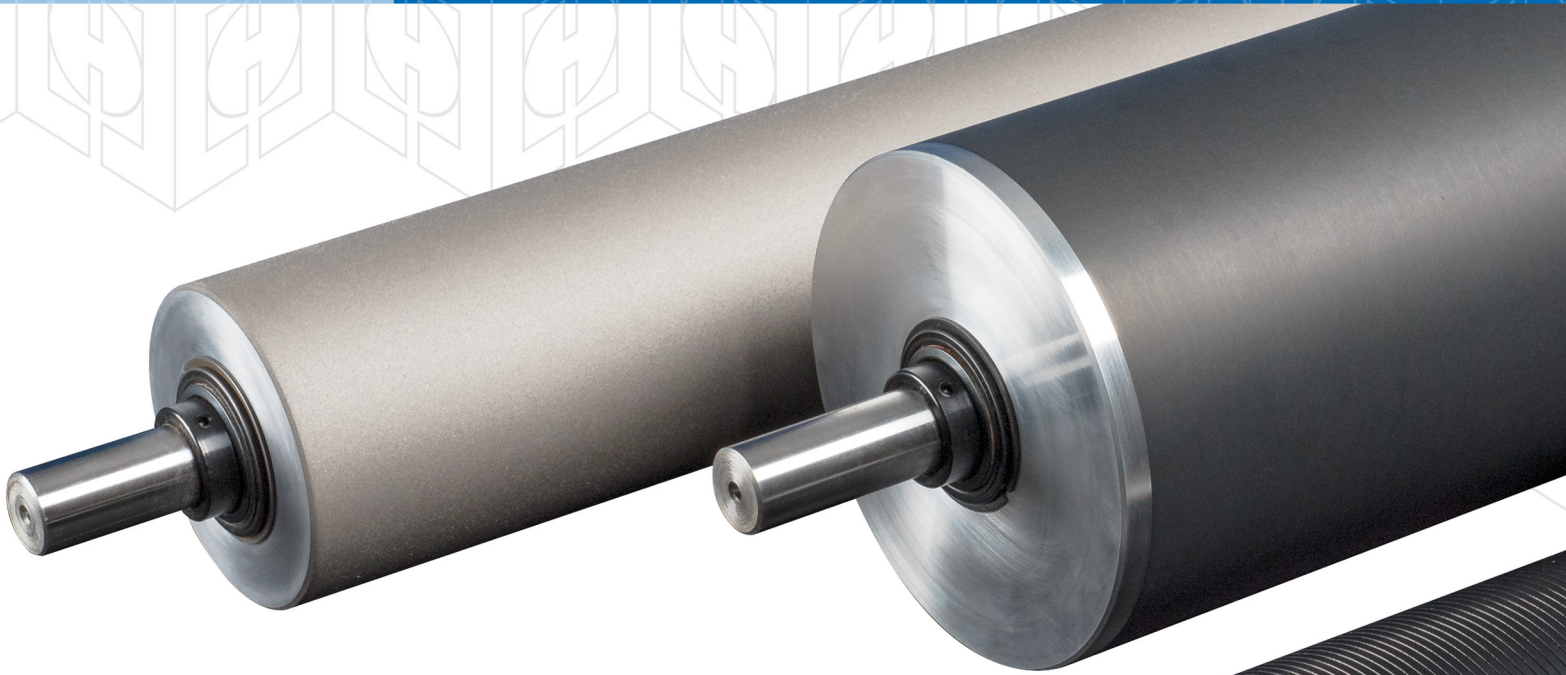

Idler Rollers



Aluminum

Carbon Fiber

Steel

Stainless Steel



Dead and Live Shaft Models

Various Coatings, Coverings, and Surface Treatments

Diameters up to 12" and Lengths up to 200"



DOUBLE E
Engineering Excellence

ee-co.com

Idler Rollers

Double E offers various roller configurations to match the requirements of any application. Each roller is configured as a dead shaft or live shaft model depending on the application specifications.

Aluminum Rollers - Standard & Lightweight

Aluminum rollers are suitable for most common applications, offering a lightweight, low inertia solution. These popular rollers are all statically and dynamically balanced to meet or exceed the customer's application requirements, and machined to precision tolerances for minimal runout and then polished for a smooth surface finish. Rollers can be delivered with various roller coverings and coatings, including hard anodization which gives the roller surface excellent wear resistance.

Standard Aluminum • Thick-wall (1/2") aluminum tube.



Lightweight Aluminum • Thin-wall (1/4") aluminum tube.

Lightweight aluminum rollers are ideal for lighter tension applications where deflection is not problematic and less rotational inertia is important.

Carbon Fiber Composite Rollers

Composite idlers are ideal for running wider, lighter webs at higher critical speeds. They are as light as possible to ramp up to speed faster, stop more quickly, and maintain line speed better than heavier rollers.

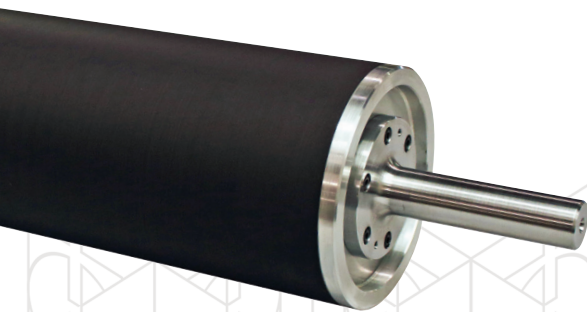

*Ultra thin-wall tube
(carbon fiber composite)*

- 75% - 80% lower rolling inertia than comparable standard aluminum.
- 85% - 90% lower total weight than comparable standard aluminum.
- Bearing assemblies have minimal breakaway torque and rolling drag.
- Resistant to corrosive environments • Reduced maintenance costs.
- Better tension control. • Surface resists denting.

Composite dead shaft rollers can be converted easily to live shaft rollers by using bolt-on live shaft journals.

Made for medium to low web tension applications, these rollers can be offered with ER style bearings and a through shaft or removable bearing carriers with steel stub shafts. The bearing carriers decrease bearing replacement time and lower the weight of the assembly.



Steel and Stainless Steel Rollers

Steel idlers offer high strength and performance in applications with wide webs, fast line speeds, and/or high web tension. Steel rollers have a higher critical speed than aluminum rollers (due to their superior stiffness), but they are heavier with greater rotational inertia.

All steel and stainless steel idlers are dynamically balanced and machined to precision tolerances for minimal runout and then polished for a smooth surface finish.

Standard Steel

- Three times the stiffness of aluminum rolls.
- Higher tensile strength and surface hardness than aluminum.

Stainless Steel

- All of the same characteristics as steel, with superior corrosion and abrasion resistance.
- Well-suited for food and medical applications.

Dead Shaft and Live Shaft Models

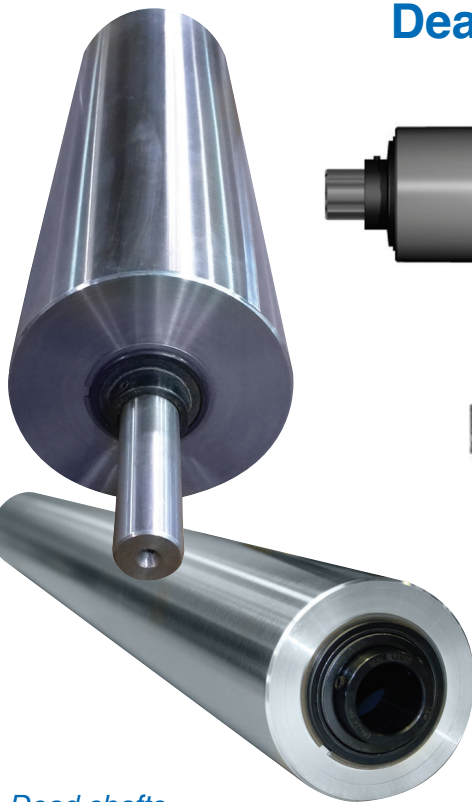

Dead shafts can be supplied with or without central shaft.

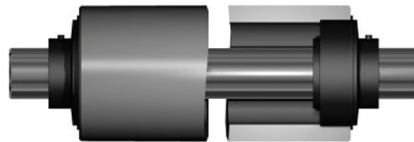

Dead Shaft

Roller rotates using special ER bearings on a fixed inner shaft.



Live Shaft

Entire roller spins together.

Bolt on journals for live shafts are offered standard on most applications for easy journal replacement.

Live shaft journals are custom manufactured according to customer specifications. This type of roller can be used as an idler or it can be driven.



Surface Treatments and Coverings

- Standard and custom coverings available including polyurethane, rubber, felt, cork, and silicone.
- Surface treatments include hardcoat anodized aluminum, chrome plated steel, plasma coating, and a variety of other types.
- * Machined surfaces include reverse crowns, spiral grooving, and micro-grooving.

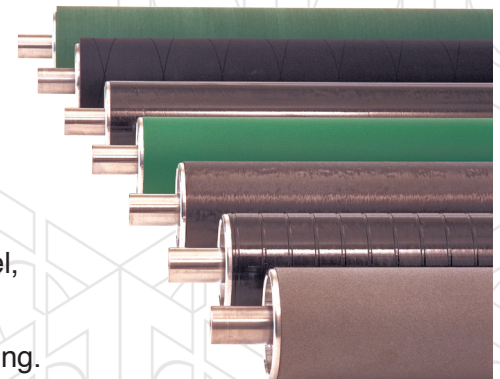

Roller Sizing

Our engineers will help to specify the proper roller type and size for any application. The chart below helps with sizing of standard aluminum rollers at various diameters, according to web width and linear tension.

Chart Key: SA = Standard Aluminum - followed by roller diameter.

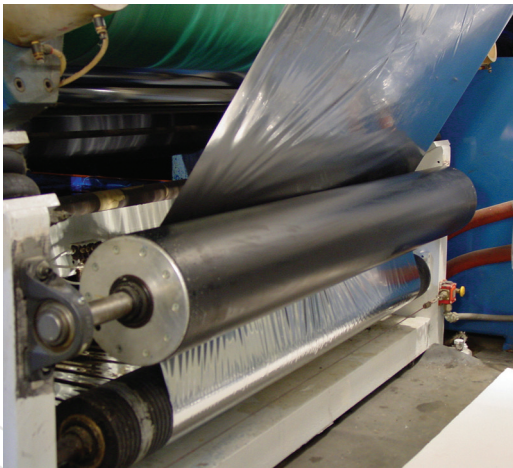
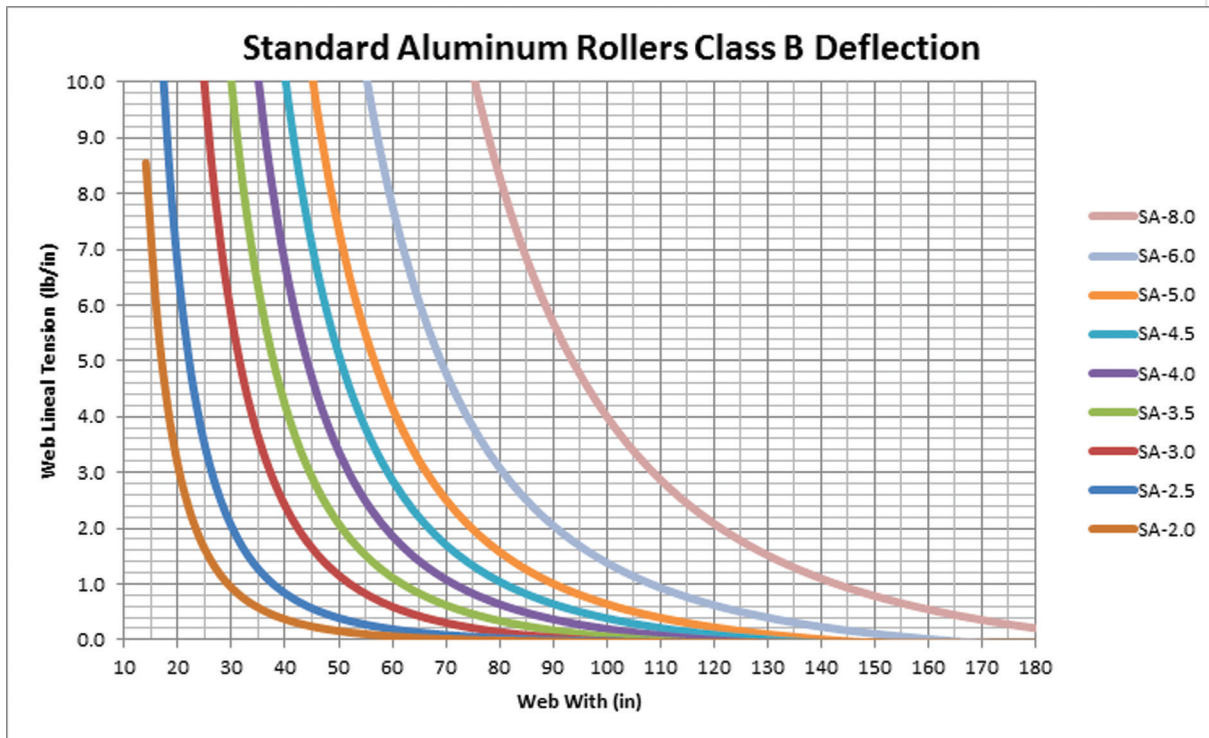

Diameters up to 12" and lengths up to 200"

