

2024

# ILTI LUCE

ILTI LUCE

# ZIRKOL

## LINEAR

### PENDANT

ZIRKOL

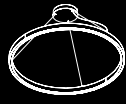

p.4

ZIRKOL CUSTOM

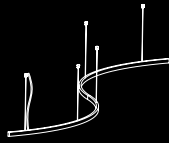

p.82

### WALL CEILING

ZIRKOL CEILING



p.30

ZIRKOL CIRCLE WALL

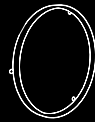

p.34

ZIRKOL LINEAR CEILING

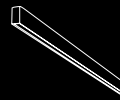

p.72

ZIRKOL LINEAR WALL



p.77

### TRACK 230V

ZIRKOL TRACK



p.80



**ZIRKOL**



reddot winner 2020  
lighting design

# ZIRKOL

## IT

La famiglia di lampade a sospensione ZIRKOL nasce con forma circolare e si estende a molteplici figure. ZIRKOL incarna il perfetto equilibrio tra design e illuminazione, combinazione che la rende irrinunciabile nel mondo dell'architettura. Ogni prodotto è disponibile in diverse finiture e dimensioni. Tutte le forme ZIRKOL sono realizzate con lo stesso profilo in alluminio per unire design ed estetica. Disponibile sia con emissione singola downlight, sia doppia uplight/downlight per garantire un comfort visivo più omogeneo. La collezione si completa ora con ZIRKOL ACOUSTIC, una lampada a sospensione che unisce illuminazione e acustica. Progettato per offrire un ambiente confortevole, si presenta con un pannello circolare fonoassorbente, rivestito da un tessuto in poliestere riciclato nella colorazione grey.

## EN

The ZIRKOL suspension lamp family emerges from the evolution of the classic round luminaire and extends to several different shapes. The ZIRKOL family represents the optimal balance between design and lighting, making it essential in the world of architecture. Each model is available in different sizes and finishes. All ZIRKOL shapes are made from the same aluminum profile to unify design and aesthetic. ZIRKOL is suitable for any kind of application, both in residential and public spaces. Available with a single downlight emission and with double uplight/downlight emission for a more homogeneous visual comfort. The collection is now extended with ZIRKOL ACOUSTIC, a pendant lamp that combines lighting and acoustics. Designed to provide a comfortable atmosphere, it features a sound-absorbing circular panel covered with a recycled polyester fabric in a grey colour.

## DE

Die Pendelleuchten-Kollektion ZIRKOL entsteht aus der kreisförmigen Form und erstreckt sich auf mehrere unterschiedliche Versionen. ZIRKOL verkörpert die perfekte Balance zwischen Design und Beleuchtung, eine Kombination, die sie in der Welt der Architektur unverzichtbar macht. Jedes Produkt ist in verschiedenen Ausführungen und Größen erhältlich. Alle ZIRKOL-Formen werden mit der gleichen Aluminiumstruktur hergestellt und verbinden somit Design und Ästhetik. Erhältlich mit einfachem Downlight oder doppeltem Uplight/Downlight-Ausgang, um einen homogenen Sehkomfort zu gewährleisten. ZIRKOL ACOUSTIC vervollständigt die Kollektion. Eine Hängeleuchte, die Beleuchtung und Akustik kombiniert. Sie bietet ein angenehmes Ambiente und ist mit einer schallabsorbierenden runden Platte ausgestattet, die mit einem grauen, recycelten Polyestergewebe bezogen ist.

## FR

La famille ZIRKOL naît avec une forme circulaire et s'étend à présent à de multiples formes avec une structure en aluminium. ZIRKOL contient l'équilibre parfait entre design et éclairage, une combinaison qui la rend indispensable dans le monde de l'architecture. Chaque produit est disponible en différentes finitions et tailles. Toutes les formes ZIRKOL sont réalisées avec le même profilé pour allier design et esthétique. Disponible en simple émission downlight et double émission uplight/downlight pour garantir un confort visuel plus homogène. La collection est désormais complétée par ZIRKOL ACOUSTIC, une suspension qui allie éclairage et acoustique. Conçue pour assurer un environnement confortable, elle comporte un panneau circulaire insonorisant, recouvert de tissu en polyester recyclé coloris gris.



Zirkol Circle, black - Zirkol Square-Q, black.  
VITA DULCIS. "Paura e desiderio nell'Impero romano",  
Palazzo delle Esposizioni, Rome







Zirkol Circle, black.  
VITA DULCIS. "Paura e desiderio nell'Impero romano",  
Palazzo delle Esposizioni, Rome

# ZIRKOL

## Shapes

dimensions in cm	85	100	150	200
------------------	----	-----	-----	-----

ZIRKOL **CIRCLE**  
p.16-35 / 44-50



| Ø85 |



| Ø100 |

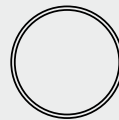

| Ø150 |

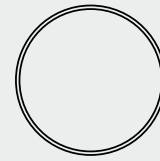

| Ø200 |

ZIRKOL **GAP**  
p.36-38



| Ø85 |



| Ø100 |



| Ø150 |

ZIRKOL **ROUND**  
p.39-42 / 51-52



| Ø100 |



| Ø150 |



| Ø200 |

ZIRKOL **SIDE**  
p.43



| Ø100 |

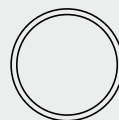

| Ø150 |

300

500

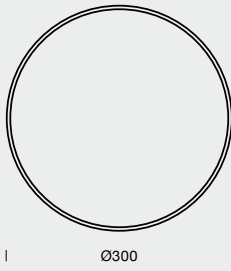

Ø300

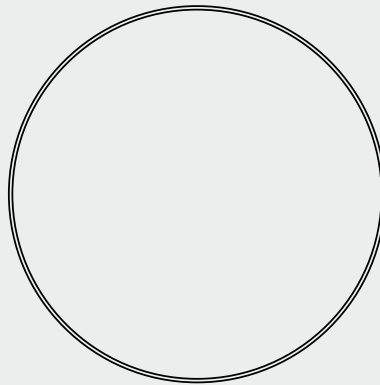

Ø500

dimensions in cm

100

150

200

250

ZIRKOL **SQUARE-S**

p.53-57

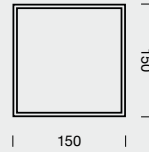
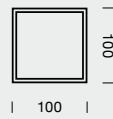

ZIRKOL **SQUARE-Q**

p.58-63

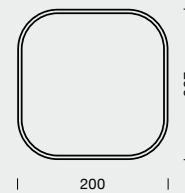
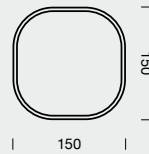

ZIRKOL **OVAL**

p.64-71

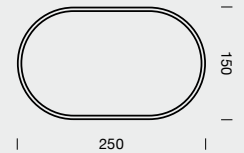
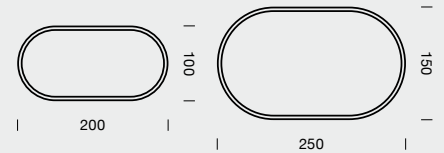

ZIRKOL **LINEAR**

p.72-81

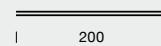

	300	350	400
--	-----	-----	-----

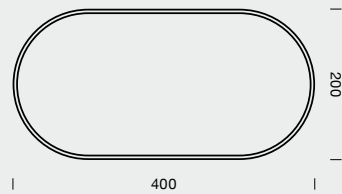
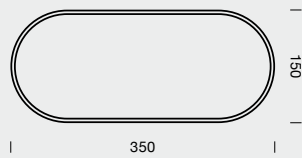
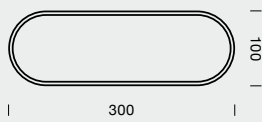
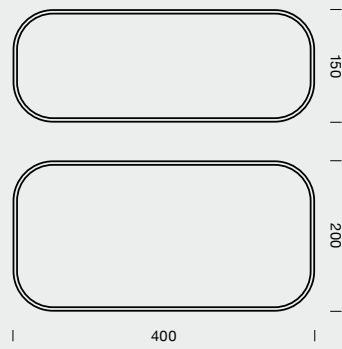
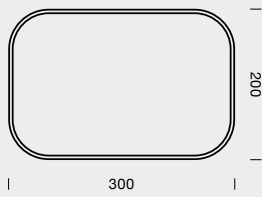

# ZIRKOL TECHNICAL INFO

## Standard

---

### EMISSION

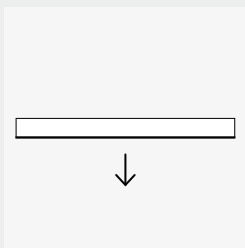

Diffused Downlight

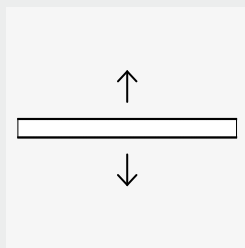

Diffused Downlight + Uplight

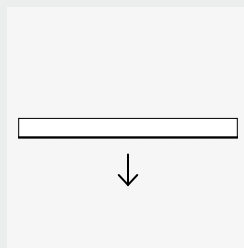

UGR

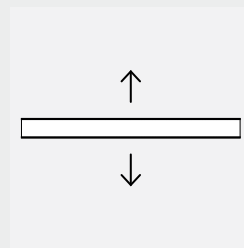

UGR + Uplight

---

### CCT

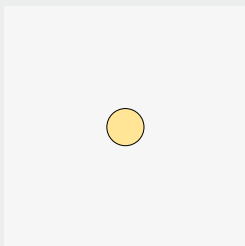

2700K

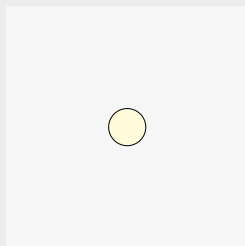

3000K

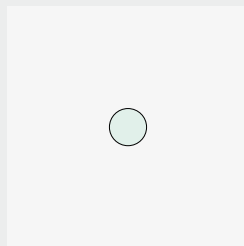

4000K

---

### CONTROL SYSTEMS

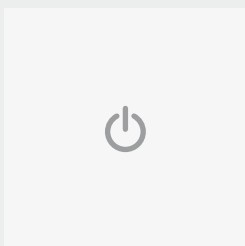

ON/OFF

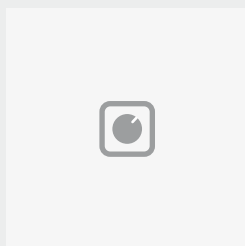

TRIAC

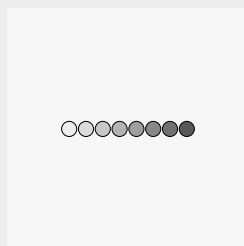

1-10V

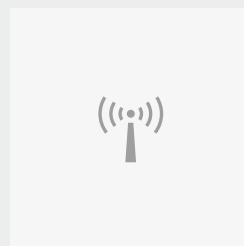

CASAMBI

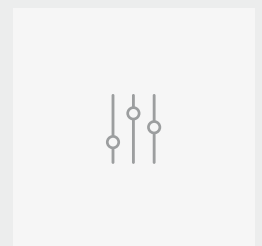

DALI

# Custom Features

---

## LIGHT CONFIGURATIONS

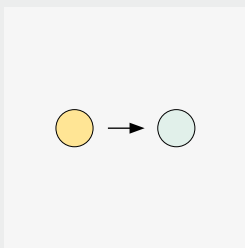

Tunable white

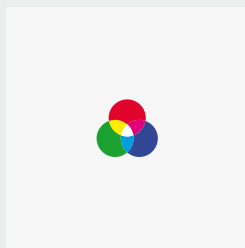

RGB

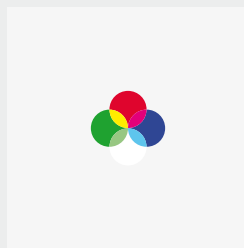

RGBW

---

## SEPARATE LIGHT CONTROL

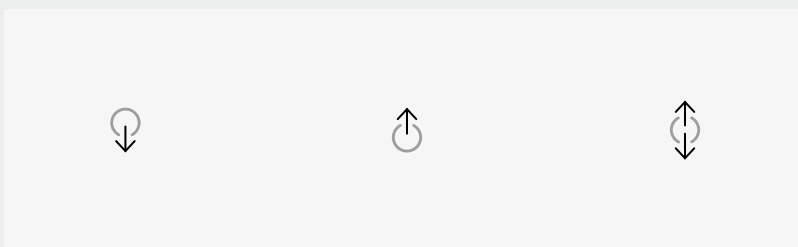

Direct

Indirect

Direct-Indirect

---

## CONTROL SYSTEMS

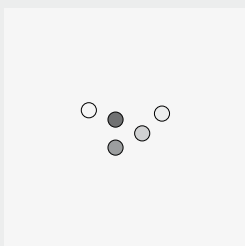

DMX/RDM

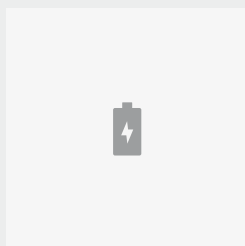

EMERGENCY KIT

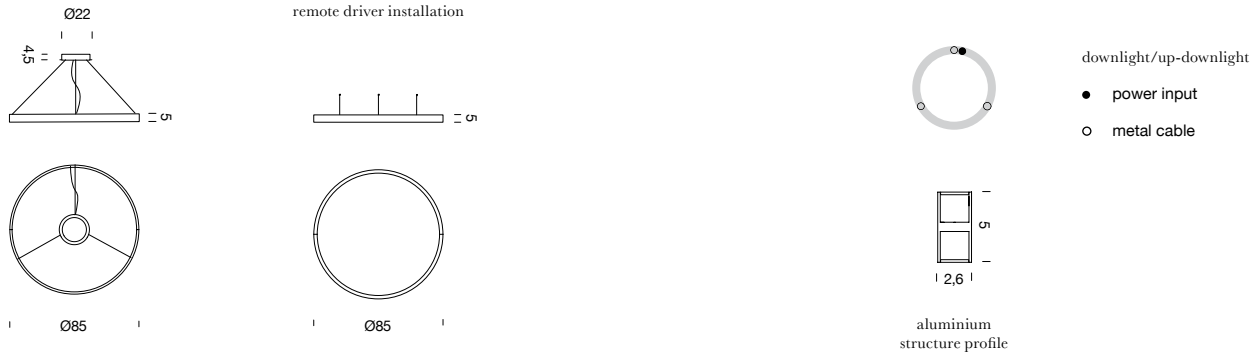

## ZIRKOL HOME - CIRCLE 0,85m | TRIAC

### DOWNLIGHT

CCT	max power	source	voltage	lum. flux	CRI	switching	code	finish
2700K	35W	LED strip	24V	2000lm	90	TRIAC	BZRC2708G15DBO	white ○
2700K	35W	LED strip	24V	2000lm	90	TRIAC	BZRC2708G15DNE	black ●
2700K	35W	LED strip	24V	2000lm	90	TRIAC	BZRC2708G15DOR	gold ●
3000K	35W	LED strip	24V	2200lm	90	TRIAC	BZRC2708G15WBO	white ○
3000K	35W	LED strip	24V	2200lm	90	TRIAC	BZRC2708G15WNE	black ●
3000K	35W	LED strip	24V	2200lm	90	TRIAC	BZRC2708G15WOR	gold ●
4000K	35W	LED strip	24V	2360lm	90	TRIAC	BZRC2708G15NBO	white ○
4000K	35W	LED strip	24V	2360lm	90	TRIAC	BZRC2708G15NNE	black ●
4000K	35W	LED strip	24V	2360lm	90	TRIAC	BZRC2708G15NOR	gold ●
note	RAL 9005 black   RAL 9016 white   shipped assembled							
included	round canopy with 1 x driver 75W (110/240V)   1 x electrical cable 4m   3 x adjustable metal cables (length from 3m to 0,5m) ceiling attachment included							
customizations	optional accessories on p.98-97   custom features on p.15							



### UP-DOWNLIGHT

CCT	max power	source	voltage	lum. flux	CRI	switching	code	finish
2700K	70W	LED strip	24V	4000lm	90	TRIAC	BZRC2808G15DBO	white ○
2700K	70W	LED strip	24V	4000lm	90	TRIAC	BZRC2808G15DNE	black ●
2700K	70W	LED strip	24V	4000lm	90	TRIAC	BZRC2808G15DOR	gold ●
3000K	70W	LED strip	24V	4400lm	90	TRIAC	BZRC2808G15WBO	white ○
3000K	70W	LED strip	24V	4400lm	90	TRIAC	BZRC2808G15WNE	black ●
3000K	70W	LED strip	24V	4400lm	90	TRIAC	BZRC2808G15WOR	gold ●
4000K	70W	LED strip	24V	4720lm	90	TRIAC	BZRC2808G15NBO	white ○
4000K	70W	LED strip	24V	4720lm	90	TRIAC	BZRC2808G15NNE	black ●
4000K	70W	LED strip	24V	4720lm	90	TRIAC	BZRC2808G15NOR	gold ●
note	RAL 9005 black   RAL 9016 white   shipped assembled							
included	round canopy with 1 x driver 75W (110/240V)   1 x electrical cable 4m   3 x adjustable metal cables (length from 3m to 0,5m) ceiling attachment included							
customizations	optional accessories on p.98-97   custom features on p.15							





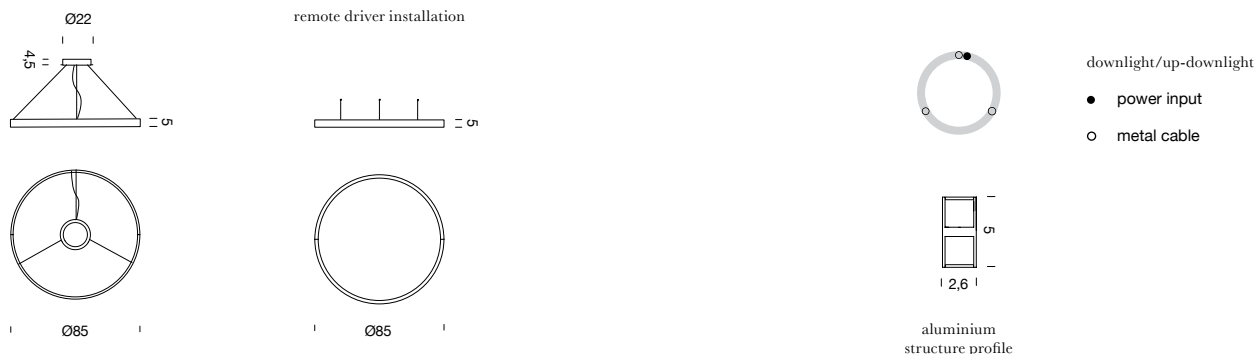

## ZIRKOL HOME - CIRCLE 0,85m | CASAMBI

### DOWNLIGHT

CCT	max power	source	voltage	lum. flux	CRI	switching	code	finish
2700K	35W	LED strip	24V	2000lm	90	CASAMBI	BZRC3308G15DBO	white ○
2700K	35W	LED strip	24V	2000lm	90	CASAMBI	BZRC3308G15DNE	black ●
2700K	35W	LED strip	24V	2000lm	90	CASAMBI	BZRC3308G15DOR	gold ●
3000K	35W	LED strip	24V	2200lm	90	CASAMBI	BZRC3308G15WBO	white ○
3000K	35W	LED strip	24V	2200lm	90	CASAMBI	BZRC3308G15WNE	black ●
3000K	35W	LED strip	24V	2200lm	90	CASAMBI	BZRC3308G15WOR	gold ●
4000K	35W	LED strip	24V	2360lm	90	CASAMBI	BZRC3308G15NBO	white ○
4000K	35W	LED strip	24V	2360lm	90	CASAMBI	BZRC3308G15NNE	black ●
4000K	35W	LED strip	24V	2360lm	90	CASAMBI	BZRC3308G15NOR	gold ●
note	RAL 9005 black   RAL 9016 white   shipped assembled							
included	round canopy with 1 x driver 75W (110/240V)   1 x dimmer CASAMBI   1 x electrical cable 4m   3 x adjustable metal cables (length from 3m to 0,5m) ceiling attachment included							
customizations	optional accessories on p.98-97   custom features on p.15							



### UP-DOWNLIGHT

CCT	max power	source	voltage	lum. flux	CRI	switching	code	finish
2700K	70W	LED strip	24V	4000lm	90	CASAMBI	BZRC3408G15DBO	white ○
2700K	70W	LED strip	24V	4000lm	90	CASAMBI	BZRC3408G15DNE	black ●
2700K	70W	LED strip	24V	4000lm	90	CASAMBI	BZRC3408G15DOR	gold ●
3000K	70W	LED strip	24V	4400lm	90	CASAMBI	BZRC3408G15WBO	white ○
3000K	70W	LED strip	24V	4400lm	90	CASAMBI	BZRC3408G15WNE	black ●
3000K	70W	LED strip	24V	4400lm	90	CASAMBI	BZRC3408G15WOR	gold ●
4000K	70W	LED strip	24V	4720lm	90	CASAMBI	BZRC3408G15NBO	white ○
4000K	70W	LED strip	24V	4720lm	90	CASAMBI	BZRC3408G15NNE	black ●
4000K	70W	LED strip	24V	4720lm	90	CASAMBI	BZRC3408G15NOR	gold ●
note	RAL 9005 black   RAL 9016 white   shipped assembled							
included	round canopy with 1 x driver 75W (110/240V)   1 x dimmer CASAMBI   1 x electrical cable 4m   3 x adjustable metal cables (length from 3m to 0,5m) ceiling attachment included							
customizations	optional accessories on p.98-97   custom features on p.15							



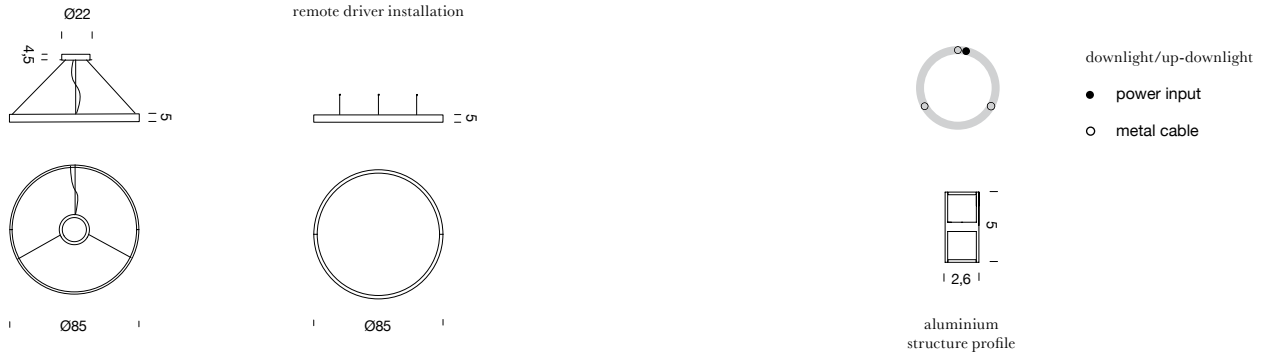

## ZIRKOL HOME - CIRCLE 0,85m | DALI

### DOWNLIGHT

CCT	max power	source	voltage	lum. flux	CRI	switching	code	finish
2700K	35W	LED strip	24V	2000lm	90	DALI	BZRC1608G15DBO	white ○
2700K	35W	LED strip	24V	2000lm	90	DALI	BZRC1608G15DNE	black ●
2700K	35W	LED strip	24V	2000lm	90	DALI	BZRC1608G15DOR	gold ●
3000K	35W	LED strip	24V	2200lm	90	DALI	BZRC1608G15WBO	white ○
3000K	35W	LED strip	24V	2200lm	90	DALI	BZRC1608G15WNE	black ●
3000K	35W	LED strip	24V	2200lm	90	DALI	BZRC1608G15WOR	gold ●
4000K	35W	LED strip	24V	2360lm	90	DALI	BZRC1608G15NBO	white ○
4000K	35W	LED strip	24V	2360lm	90	DALI	BZRC1608G15NNE	black ●
4000K	35W	LED strip	24V	2360lm	90	DALI	BZRC1608G15NOR	gold ●
note	RAL 9005 black   RAL 9016 white   shipped assembled							
included	round canopy with 1 x driver 75W (110/240V)   1 x dimmer DALI   1 x electrical cable 4m   3 x adjustable metal cables (length from 3m to 0,5m) ceiling attachment included							
customizations	optional accessories on p.98-97   custom features on p.15							



### UP-DOWNLIGHT

CCT	max power	source	voltage	lum. flux	CRI	switching	code	finish
2700K	70W	LED strip	24V	4000lm	90	DALI	BZRC1708G15DBO	white ○
2700K	70W	LED strip	24V	4000lm	90	DALI	BZRC1708G15DNE	black ●
2700K	70W	LED strip	24V	4000lm	90	DALI	BZRC1708G15DOR	gold ●
3000K	70W	LED strip	24V	4400lm	90	DALI	BZRC1708G15WBO	white ○
3000K	70W	LED strip	24V	4400lm	90	DALI	BZRC1708G15WNE	black ●
3000K	70W	LED strip	24V	4400lm	90	DALI	BZRC1708G15WOR	gold ●
4000K	70W	LED strip	24V	4720lm	90	DALI	BZRC1708G15NBO	white ○
4000K	70W	LED strip	24V	4720lm	90	DALI	BZRC1708G15NNE	black ●
4000K	70W	LED strip	24V	4720lm	90	DALI	BZRC1708G15NOR	gold ●
note	RAL 9005 black   RAL 9016 white   shipped assembled							
included	round canopy with 1 x driver 75W (110/240V)   1 x dimmer DALI   1 x electrical cable 4m   3 x adjustable metal cables (length from 3m to 0,5m) ceiling attachment included							
customizations	optional accessories on p.98-97   custom features on p.15							



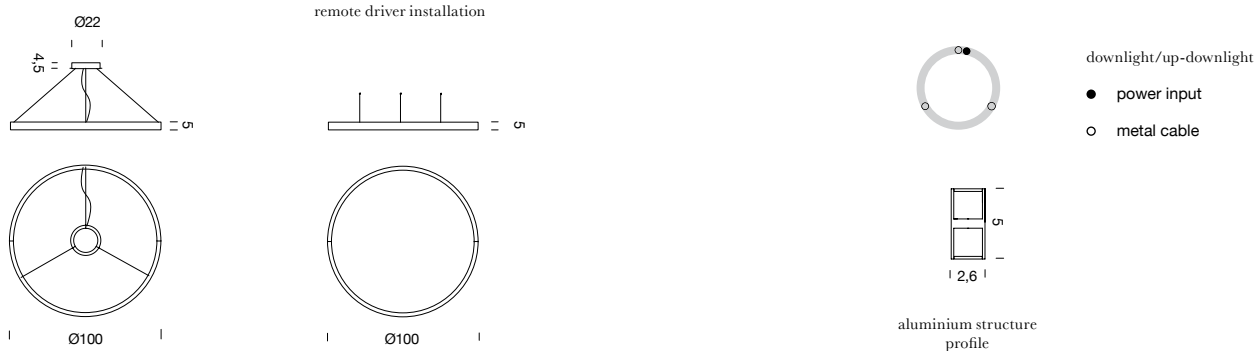

## ZIRKOL HOME - CIRCLE 1m | TRIAC

### DOWNLIGHT

CCT	max power	source	voltage	lum. flux	CRI	switching	code	finish	
2700K	45W	LED strip	24V	2616lm	90	TRIAC	BZRC2710G15DBO	white ○	
2700K	45W	LED strip	24V	2616lm	90	TRIAC	BZRC2710G15DNE	black ●	
2700K	45W	LED strip	24V	2616lm	90	TRIAC	BZRC2710G15DOR	gold ●	
3000K	45W	LED strip	24V	2769lm	90	TRIAC	BZRC2710G15WBO	white ○	
3000K	45W	LED strip	24V	2769lm	90	TRIAC	BZRC2710G15WNE	black ●	
3000K	45W	LED strip	24V	2769lm	90	TRIAC	BZRC2710G15WOR	gold ●	
4000K	45W	LED strip	24V	3077lm	90	TRIAC	BZRC2710G15NBO	white ○	
4000K	45W	LED strip	24V	3077lm	90	TRIAC	BZRC2710G15NNE	black ●	
4000K	45W	LED strip	24V	3077lm	90	TRIAC	BZRC2710G15NOR	gold ●	
note	RAL 9005 black   RAL 9016 white   shipped assembled								
included	round canopy with 1 x driver 75W (110/240V)   1 x electrical cable 4m   3 x adjustable metal cable (length from 3m to 0,5m) ceiling attachment included								
customizations	optional accessories on p.98-97   custom features on p.15								



### UP-DOWNLIGHT

CCT	max power	source	voltage	lum. flux	CRI	switching	code	finish	
2700K	90W	LED strip	24V	5231lm	90	TRIAC	BZRC2810G15DBO	white ○	
2700K	90W	LED strip	24V	5231lm	90	TRIAC	BZRC2810G15DNE	black ●	
2700K	90W	LED strip	24V	5231lm	90	TRIAC	BZRC2810G15DOR	gold ●	
3000K	90W	LED strip	24V	5539lm	90	TRIAC	BZRC2810G15WBO	white ○	
3000K	90W	LED strip	24V	5539lm	90	TRIAC	BZRC2810G15WNE	black ●	
3000K	90W	LED strip	24V	5539lm	90	TRIAC	BZRC2810G15WOR	gold ●	
4000K	90W	LED strip	24V	6154lm	90	TRIAC	BZRC2810G15NBO	white ○	
4000K	90W	LED strip	24V	6154lm	90	TRIAC	BZRC2810G15NNE	black ●	
4000K	90W	LED strip	24V	6154lm	90	TRIAC	BZRC2810G15NOR	gold ●	
note	RAL 9005 black   RAL 9016 white   shipped assembled								
included	round canopy with 1 x driver 96W (110/240V)   1 x electrical cable 4m   3 x adjustable metal cable (length from 3m to 0,5m) ceiling attachment included								
customizations	optional accessories on p.98-97   custom features on p.15								







Zirkol Circle, white.  
Hages Badehotel,  
Rodby, Denmark

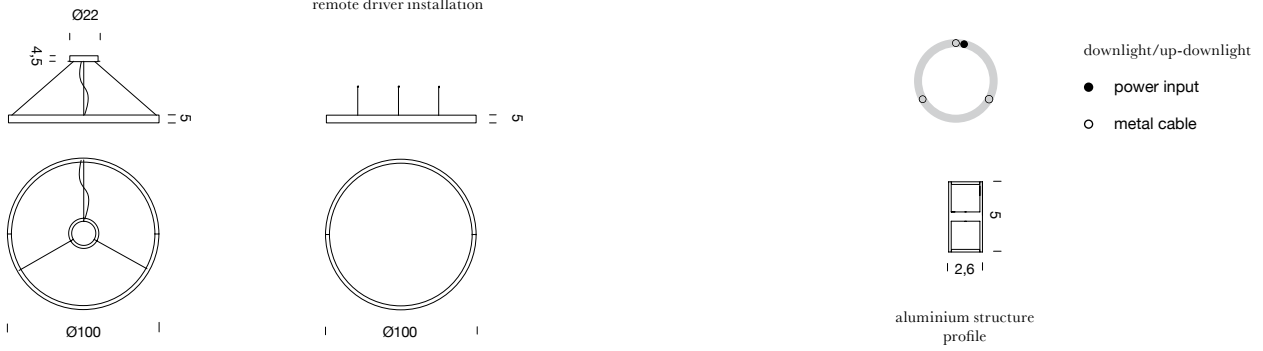

## ZIRKOL HOME - CIRCLE 1m | CASAMBI

### DOWNLIGHT

CCT	max power	source	voltage	lum. flux	CRI	switching	code	finish	
2700K	45W	LED strip	24V	2616lm	90	CASAMBI	BZRC3310G15DBO	white	○
2700K	45W	LED strip	24V	2616lm	90	CASAMBI	BZRC3310G15DNE	black	●
2700K	45W	LED strip	24V	2616lm	90	CASAMBI	BZRC3310G15DOR	gold	●
3000K	45W	LED strip	24V	2769lm	90	CASAMBI	BZRC3310G15WBO	white	○
3000K	45W	LED strip	24V	2769lm	90	CASAMBI	BZRC3310G15WNE	black	●
3000K	45W	LED strip	24V	2769lm	90	CASAMBI	BZRC3310G15WOR	gold	●
4000K	45W	LED strip	24V	3077lm	90	CASAMBI	BZRC3310G15NBO	white	○
4000K	45W	LED strip	24V	3077lm	90	CASAMBI	BZRC3310G15NNE	black	●
4000K	45W	LED strip	24V	3077lm	90	CASAMBI	BZRC3310G15NOR	gold	●
note	RAL 9005 black   RAL 9016 white   shipped assembled								
included	round canopy with 1 x driver 75W (110/240V)   1 x dimmer CASAMBI   1 x electrical cable 4m   3 x adjustable metal cable (length from 3m to 0,5m) ceiling attachment included								
customizations	optional accessories on p.98-97   custom features on p.15								



### UP-DOWNLIGHT

CCT	max power	source	voltage	lum. flux	CRI	switching	code	finish	
2700K	90W	LED strip	24V	5231lm	90	CASAMBI	BZRC3410G15DBO	white	○
2700K	90W	LED strip	24V	5231lm	90	CASAMBI	BZRC3410G15DNE	black	●
2700K	90W	LED strip	24V	5231lm	90	CASAMBI	BZRC3410G15DOR	gold	●
3000K	90W	LED strip	24V	5539lm	90	CASAMBI	BZRC3410G15WBO	white	○
3000K	90W	LED strip	24V	5539lm	90	CASAMBI	BZRC3410G15WNE	black	●
3000K	90W	LED strip	24V	5539lm	90	CASAMBI	BZRC3410G15WOR	gold	●
4000K	90W	LED strip	24V	6154lm	90	CASAMBI	BZRC3410G15NBO	white	○
4000K	90W	LED strip	24V	6154lm	90	CASAMBI	BZRC3410G15NNE	black	●
4000K	90W	LED strip	24V	6154lm	90	CASAMBI	BZRC3410G15NOR	gold	●
note	RAL 9005 black   RAL 9016 white   shipped assembled								
included	round canopy with 1 x driver 100W (110-240V)   1 x dimmer CASAMBI   1 x electrical cable 4m   3 x adjustable metal cable (length from 3m to 0,5m) ceiling attachment included								
customizations	optional accessories on p.98-97   custom features on p.15								



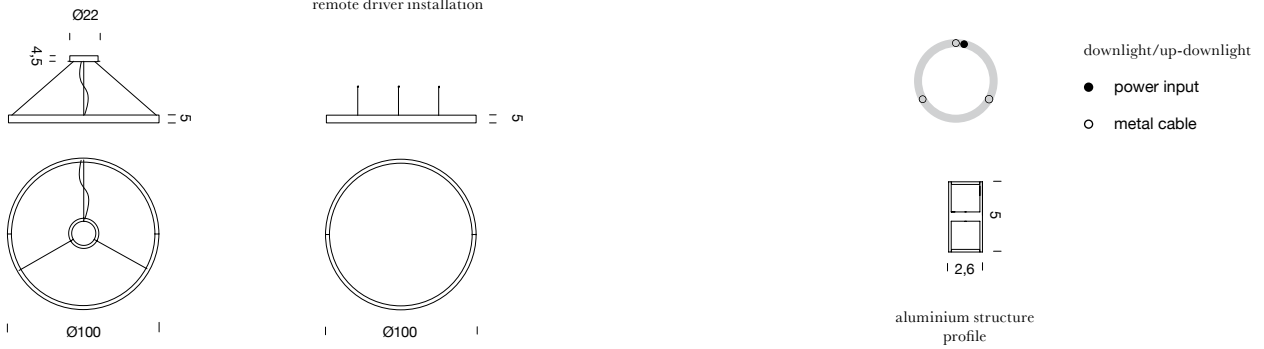

## ZIRKOL HOME - CIRCLE 1m | DALI

### DOWNLIGHT

CCT	max power	source	voltage	lum. flux	CRI	switching	code	finish	
2700K	45W	LED strip	24V	2616lm	90	DALI	BZRC1610G15DBO	white ○	
2700K	45W	LED strip	24V	2616lm	90	DALI	BZRC1610G15DNE	black ●	
2700K	45W	LED strip	24V	2616lm	90	DALI	BZRC1610G15DOR	gold ●	
3000K	45W	LED strip	24V	2769lm	90	DALI	BZRC1610G15WBO	white ○	
3000K	45W	LED strip	24V	2769lm	90	DALI	BZRC1610G15WNE	black ●	
3000K	45W	LED strip	24V	2769lm	90	DALI	BZRC1610G15WOR	gold ●	
4000K	45W	LED strip	24V	3077lm	90	DALI	BZRC1610G15NBO	white ○	
4000K	45W	LED strip	24V	3077lm	90	DALIX	BZRC1610G15NNE	black ●	
4000K	45W	LED strip	24V	3077lm	90	DALI	BZRC1610G15NOR	gold ●	
note	RAL 9005 black   RAL 9016 white   shipped assembled								
included	round canopy with 1 x driver 75W (110/240V)   1 x dimmer DALI   1 x electrical cable 4m   3 x adjustable metal cable (length from 3m to 0,5m) ceiling attachment included								
customizations	optional accessories on p.98-97   custom features on p.15								



### UP-DOWNLIGHT

CCT	max power	source	voltage	lum. flux	CRI	switching	code	finish	
2700K	90W	LED strip	24V	5231lm	90	DALI	BZRC1710G15DBO	white ○	
2700K	90W	LED strip	24V	5231lm	90	DALI	BZRC1710G15DNE	black ●	
2700K	90W	LED strip	24V	5231lm	90	DALI	BZRC1710G15DOR	gold ●	
3000K	90W	LED strip	24V	5539lm	90	DALI	BZRC1710G15WBO	white ○	
3000K	90W	LED strip	24V	5539lm	90	DALI	BZRC1710G15WNE	black ●	
3000K	90W	LED strip	24V	5539lm	90	DALI	BZRC1710G15WOR	gold ●	
4000K	90W	LED strip	24V	6154lm	90	DALI	BZRC1710G15NBO	white ○	
4000K	90W	LED strip	24V	6154lm	90	DALI	BZRC1710G15NNE	black ●	
4000K	90W	LED strip	24V	6154lm	90	DALI	BZRC1710G15NOR	gold ●	
note	RAL 9005 black   RAL 9016 white   shipped assembled								
included	round canopy with 1 x driver 100W (110-240V)   1 x dimmer DALI   1 x electrical cable 4m   3 x adjustable metal cable (length from 3m to 0,5m) ceiling attachment included								
customizations	optional accessories on p.98-97   custom features on p.15								



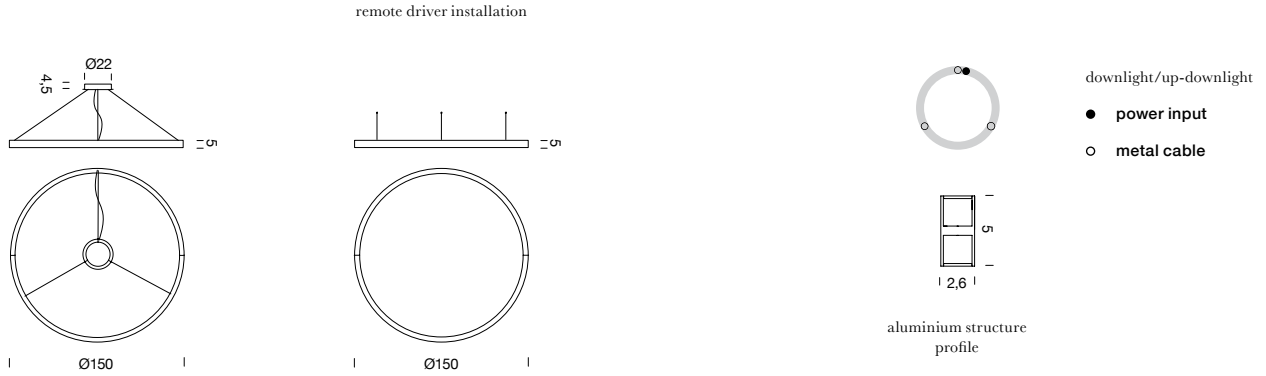

## ZIRKOL HOME - CIRCLE 1,5m | DALI

### DOWNLIGHT

CCT	max power	source	voltage	lum. flux	CRI	switching	code	finish	
2700K	68W	LED strip	24V	3923lm	90	DALI	BZRC1615G15DBO	white ○	
2700K	68W	LED strip	24V	3923lm	90	DALI	BZRC1615G15DNE	black ●	
2700K	68W	LED strip	24V	3923lm	90	DALI	BZRC1615G15DOR	gold ●	
3000K	68W	LED strip	24V	4154lm	90	DALI	BZRC1615G15WBO	white ○	
3000K	68W	LED strip	24V	4154lm	90	DALI	BZRC1615G15WNE	black ●	
3000K	68W	LED strip	24V	4154lm	90	DALI	BZRC1615G15WOR	gold ●	
4000K	68W	LED strip	24V	4616lm	90	DALI	BZRC1615G15NBO	white ○	
4000K	68W	LED strip	24V	4616lm	90	DALI	BZRC1615G15NNE	black ●	
4000K	68W	LED strip	24V	4616lm	90	DALI	BZRC1615G15NOR	gold ●	
note	RAL 9005 black   RAL 9016 white   shipped assembled								
included	round canopy with 1 x driver 75W (110/24V)   1 x dimmer DALI   1 x electrical cable 4m   3 x adjustable metal cable (length from 3m to 0,5m) ceiling attachment included								
customizations	optional accessories on p.98-97   custom features on p.15								

CE UK CA IP40

### UP-DOWNLIGHT

CCT	max power	source	voltage	lum. flux	CRI	switching	code	finish	
2700K	136W	LED strip	24V	7847lm	90	DALI	BZRC1715G15DBO	white ○	
2700K	136W	LED strip	24V	7847lm	90	DALI	BZRC1715G15DNE	black ●	
2700K	136W	LED strip	24V	7847lm	90	DALI	BZRC1715G15DOR	gold ●	
3000K	136W	LED strip	24V	8308lm	90	DALI	BZRC1715G15WBO	white ○	
3000K	136W	LED strip	24V	8308lm	90	DALI	BZRC1715G15WNE	black ●	
3000K	136W	LED strip	24V	8308lm	90	DALI	BZRC1715G15WOR	gold ●	
4000K	136W	LED strip	24V	9232lm	90	DALI	BZRC1715G15NBO	white ○	
4000K	136W	LED strip	24V	9232lm	90	DALI	BZRC1715G15NNE	black ●	
4000K	136W	LED strip	24V	9232lm	90	DALI	BZRC1715G15NOR	gold ●	
note	RAL 9005 black   RAL 9016 white   shipped assembled								
included	round canopy with 1 x driver 150W (220/240V)   1 x dimmer DALI   1 x electrical cable 4m   3 x adjustable metal cable (length from 3m to 0,5m) ceiling attachment included								
customizations	optional accessories on p.98-97   custom features on p.15								

CE UK CA IP40





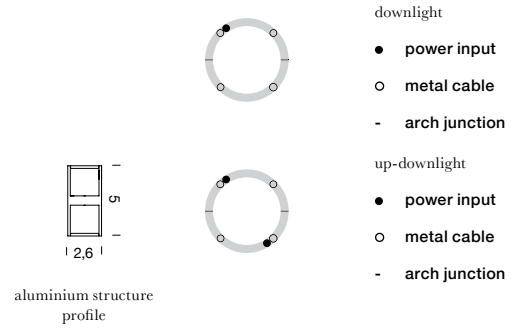
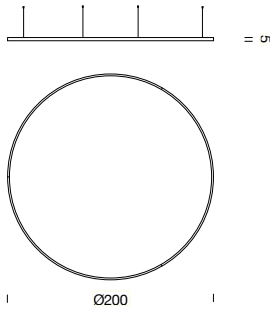

## ZIRKOL CIRCLE 2m | DALI

### DOWNLIGHT

CCT	max power	source	voltage	lum. flux	CRI	switching	code	finish
2700K	90W	LED strip	24V	5260lm	90	DALI	BZRC1620G15DBO	white ○
2700K	90W	LED strip	24V	5260lm	90	DALI	BZRC1620G15DNE	black ●
2700K	90W	LED strip	24V	5260lm	90	DALI	BZRC1620G15DOR	gold ●
3000K	90W	LED strip	24V	5539lm	90	DALI	BZRC1620G15WBO	white ○
3000K	90W	LED strip	24V	5539lm	90	DALI	BZRC1620G15WNE	black ●
3000K	90W	LED strip	24V	5539lm	90	DALI	BZRC1620G15WOR	gold ●
4000K	90W	LED strip	24V	6154lm	90	DALI	BZRC1620G15NBO	white ○
4000K	90W	LED strip	24V	6154lm	90	DALI	BZRC1620G15NNE	black ●
4000K	90W	LED strip	24V	6154lm	90	DALI	BZRC1620G15NOR	gold ●

note remote driver | RAL 9005 black | RAL 9016 white | shipped in 2 pieces

included 1 x driver 100W (110/240V) | 1 x dimmer DALI | 1 x electrical cable 5m | 4 x adjustable metal cable length 3m (ceiling attachment included)

optional accessory driver box | ceiling plate for remote driver (more specification on p.98-97)

customizations find customizable features on p.15



### UP-DOWNLIGHT

CCT	max power	source	voltage	lum. flux	CRI	switching	code	finish
2700K	180W	LED strip	24V	10500lm	90	DALI	BZRC1720G15DBO	white ○
2700K	180W	LED strip	24V	10500lm	90	DALI	BZRC1720G15DNE	black ●
2700K	180W	LED strip	24V	10500lm	90	DALI	BZRC1720G15DOR	gold ●
3000K	180W	LED strip	24V	11078lm	90	DALI	BZRC1720G15WBO	white ○
3000K	180W	LED strip	24V	11078lm	90	DALI	BZRC1720G15WNE	black ●
3000K	180W	LED strip	24V	11078lm	90	DALI	BZRC1720G15WOR	gold ●
4000K	180W	LED strip	24V	12309lm	90	DALI	BZRC1720G15NBO	white ○
4000K	180W	LED strip	24V	12309lm	90	DALI	BZRC1720G15NNE	black ●
4000K	180W	LED strip	24V	12309lm	90	DALI	BZRC1720G15NOR	gold ●

note remote driver | RAL 9005 black | RAL 9016 white | shipped in 2 pieces

included 1 x driver 250W (220/240V) | 1 x dimmer DALI | 2 x electrical cable 5m | 4 x adjustable metal cable length 3m (ceiling attachment included)

optional accessory driver box | ceiling plate for remote driver (more specification on p.98-97)

customizations find customizable features on p.15



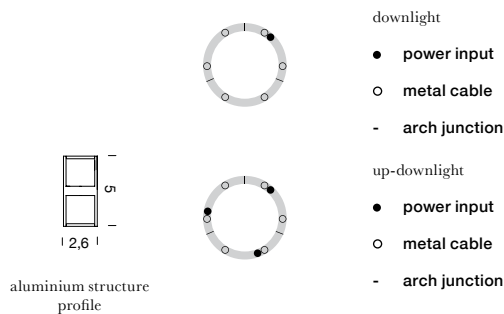
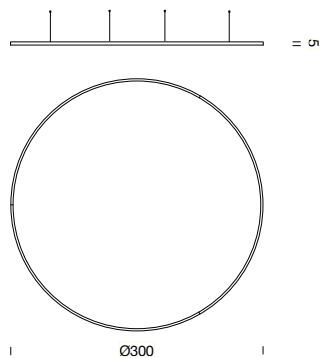

## ZIRKOL CIRCLE 3m | DALI

### DOWNLIGHT

CCT	max power	source	voltage	lum. flux	CRI	switching	code	finish
2700K	134W	LED strip	24V	7820lm	90	DALI	BZRC1630G15DBO	white ○
2700K	134W	LED strip	24V	7820lm	90	DALI	BZRC1630G15DNE	black ●
2700K	134W	LED strip	24V	7820lm	90	DALI	BZRC1630G15DOR	gold ●
3000K	134W	LED strip	24V	8238lm	90	DALI	BZRC1630G15WBO	white ○
3000K	134W	LED strip	24V	8238lm	90	DALI	BZRC1630G15WNE	black ●
3000K	134W	LED strip	24V	8238lm	90	DALI	BZRC1630G15WOR	gold ●
4000K	134W	LED strip	24V	9153lm	90	DALI	BZRC1630G15NBO	white ○
4000K	134W	LED strip	24V	9153lm	90	DALI	BZRC1630G15NNE	black ●
4000K	134W	LED strip	24V	9153lm	90	DALI	BZRC1630G15NOR	gold ●

note remote driver | RAL 9005 black | RAL 9016 white | shipped in 3 pieces

included 1 x driver 150W (220/240V) | 1 x dimmer DALI | 1 x electrical cable 5m | 6 x adjustable metal cable length 3m (ceiling attachment included)

optional accessory driver box | ceiling plate for remote driver (more specification on p.98-97)

customizations find customizable features on p.15



### UP-DOWNLIGHT

CCT	max power	source	voltage	lum. flux	CRI	switching	code	finish
2700K	268W	LED strip	24V	15640lm	90	DALI	BZRC1730G15DBO	white ○
2700K	268W	LED strip	24V	15640lm	90	DALI	BZRC1730G15DNE	black ●
2700K	268W	LED strip	24V	15640lm	90	DALI	BZRC1730G15DOR	gold ●
3000K	268W	LED strip	24V	16476lm	90	DALI	BZRC1730G15WBO	white ○
3000K	268W	LED strip	24V	16476lm	90	DALI	BZRC1730G15WNE	black ●
3000K	268W	LED strip	24V	16476lm	90	DALI	BZRC1730G15WOR	gold ●
4000K	268W	LED strip	24V	18306lm	90	DALI	BZRC1730G15NBO	white ○
4000K	268W	LED strip	24V	18306lm	90	DALI	BZRC1730G15NNE	black ●
4000K	268W	LED strip	24V	18306lm	90	DALI	BZRC1730G15NOR	gold ●

note remote driver | RAL 9005 black | RAL 9016 white | shipped in 3 pieces

included 3 x drivers 100 (110/240V) | 3 x dimmer DALI | 3 x electrical cable 5m | 6 x adjustable metal cable length 3m (ceiling attachment included)

optional accessory driver box | ceiling plate for remote driver (more specification on p.98-97)

customizations find customizable features on p.15



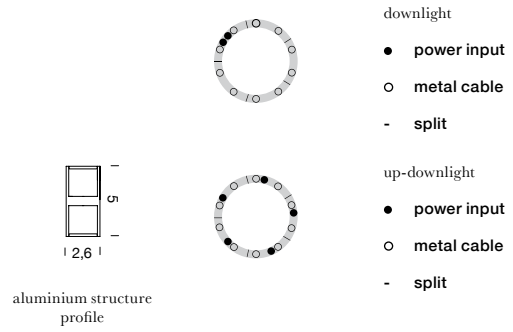
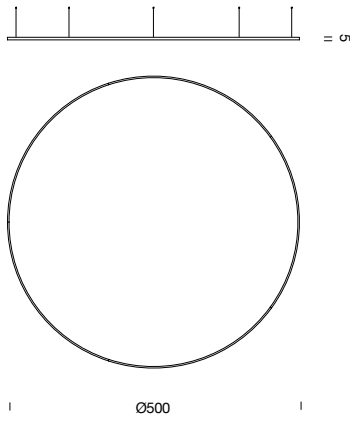

## ZIRKOL CIRCLE 5m | DALI

### DOWNLIGHT

CCT	max power	source	voltage	lum. flux	CRI	switching	code	finish
2700K	226W	LED strip	24V	13100lm	90	DALI	BZRC1650G15DBO	white ○
2700K	226W	LED strip	24V	13100lm	90	DALI	BZRC1650G15DNE	black ●
2700K	226W	LED strip	24V	13100lm	90	DALI	BZRC1650G15DOR	gold ●
3000K	226W	LED strip	24V	13847lm	90	DALI	BZRC1650G15WBO	white ○
3000K	226W	LED strip	24V	13847lm	90	DALI	BZRC1650G15WNE	black ●
3000K	226W	LED strip	24V	13847lm	90	DALI	BZRC1650G15WOR	gold ●
4000K	226W	LED strip	24V	15386lm	90	DALI	BZRC1650G15NBO	white ○
4000K	226W	LED strip	24V	15386lm	90	DALI	BZRC1650G15NNE	black ●
4000K	226W	LED strip	24V	15386lm	90	DALI	BZRC1650G15NOR	gold ●

note remote driver | RAL 9005 black | RAL 9016 white | shipped in 5 pieces

included 1 x driver 250W (220/240V) | 1 x dimmer DALI | 2 x electrical cable 5m | 10 x adjustable metal cable length 3m (ceiling attachment included)

optional accessory driver box | ceiling plate for remote driver (more specification on p.98-97)

customizations find customizable features on p.15



### UP-DOWNLIGHT

CCT	max power	source	voltage	lum. flux	CRI	switching	code	finish
2700K	452W	LED strip	24V	26100lm	90	DALI	BZRC1750G15DBO	white ○
2700K	452W	LED strip	24V	26100lm	90	DALI	BZRC1750G15DNE	black ●
2700K	452W	LED strip	24V	26100lm	90	DALI	BZRC1750G15DOR	gold ●
3000K	452W	LED strip	24V	27695lm	90	DALI	BZRC1750G15WBO	white ○
3000K	452W	LED strip	24V	27695lm	90	DALI	BZRC1750G15WNE	black ●
3000K	452W	LED strip	24V	27695lm	90	DALI	BZRC1750G15WOR	gold ●
4000K	452W	LED strip	24V	30772lm	90	DALI	BZRC1750G15NBO	white ○
4000K	452W	LED strip	24V	30772lm	90	DALI	BZRC1750G15NNE	black ●
4000K	452W	LED strip	24V	30772lm	90	DALI	BZRC1750G15NOR	gold ●

note remote driver | RAL 9005 black | RAL 9016 white | shipped in 5 pieces

included 5 x driver 100W (110/240V) | 5 x dimmer DALI | 5 x electrical cable 5m | 10 x adjustable metal cable 3m (ceiling attachment included)

optional accessory driver box | ceiling plate for remote driver (more specification on p.98-97)

customizations find customizable features on p.15





Zirkol Circle, gold.  
Private project, Manchester





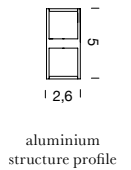
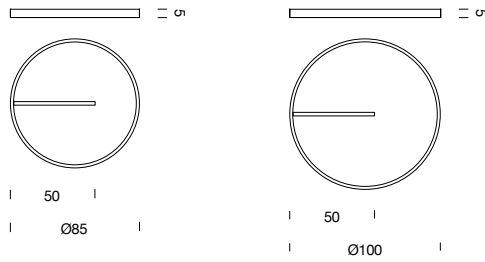

## ZIRKOL CEILING 0,85m | DALI

CCT	max power	source	voltage	lum. flux	CRI	switching	code	finish	
2700K	35W	LED strip	24V	2000lm	90	DALI	BZRCD408G15DBO	white	○
2700K	35W	LED strip	24V	2000lm	90	DALI	BZRCD408G15DNE	black	●
2700K	35W	LED strip	24V	2000lm	90	DALI	BZRCD408G15DOR	gold	●
3000K	35W	LED strip	24V	2200lm	90	DALI	BZRCD408G15WBO	white	○
3000K	35W	LED strip	24V	2200lm	90	DALI	BZRCD408G15WNE	black	●
3000K	35W	LED strip	24V	2200lm	90	DALI	BZRCD408G15WOR	gold	●
4000K	35W	LED strip	24V	2360lm	90	DALI	BZRCD408G15NBO	white	○
4000K	35W	LED strip	24V	2360lm	90	DALI	BZRCD408G15NNE	black	●
4000K	35W	LED strip	24V	2360lm	90	DALI	BZRCD408G15NOR	gold	●
note	RAL 9005 black   RAL 9016 white   shipped assembled								
integrated driver	driver box with 1 x driver Superslim 60W Dali2/Push Dali (220/240V)								
customizations	lumen output, finish								

CE UK CA IP40

## ZIRKOL CEILING 1m | DALI

CCT	max power	source	voltage	lum. flux	CRI	switching	code	finish	
2700K	45W	LED strip	24V	2616lm	90	DALI	BZRCD410G15DBO	white	○
2700K	45W	LED strip	24V	2616lm	90	DALI	BZRCD410G15DNE	black	●
2700K	45W	LED strip	24V	2616lm	90	DALI	BZRCD410G15DOR	gold	●
3000K	45W	LED strip	24V	2769lm	90	DALI	BZRCD410G15WBO	white	○
3000K	45W	LED strip	24V	2769lm	90	DALI	BZRCD410G15WNE	black	●
3000K	45W	LED strip	24V	2769lm	90	DALI	BZRCD410G15WOR	gold	●
4000K	45W	LED strip	24V	3077lm	90	DALI	BZRCD410G15NBO	white	○
4000K	45W	LED strip	24V	3077lm	90	DALI	BZRCD410G15NNE	black	●
4000K	45W	LED strip	24V	3077lm	90	DALI	BZRCD410G15NOR	gold	●
note	RAL 9005 black   RAL 9016 white   shipped assembled								
integrated driver	driver box with 1 x driver Superslim 60W Dali2/Push Dali (220/240V)								
customizations	lumen output, finish								

CE UK CA IP40



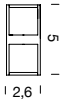
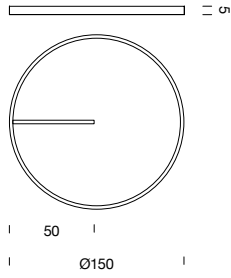

aluminium structure profile

## ZIRKOL CEILING 1,5m | DALI

CCT	max power	source	voltage	lum. flux	CRI	switching	code	finish	
2700K	60W	LED strip	24V	3923lm	90	DALI	BZRCD415G15DBO	white	○
2700K	60W	LED strip	24V	3923lm	90	DALI	BZRCD415G15DNE	black	●
2700K	60W	LED strip	24V	3923lm	90	DALI	BZRCD415G15DOR	gold	●
3000K	60W	LED strip	24V	4154lm	90	DALI	BZRCD415G15WBO	white	○
3000K	60W	LED strip	24V	4154lm	90	DALI	BZRCD415G15WNE	black	●
3000K	60W	LED strip	24V	4154lm	90	DALI	BZRCD415G15WOR	gold	●
4000K	60W	LED strip	24V	4616lm	90	DALI	BZRCD415G15NBO	white	○
4000K	60W	LED strip	24V	4616lm	90	DALI	BZRCD415G15NNE	black	●
4000K	60W	LED strip	24V	4616lm	90	DALI	BZRCD415G15NOR	gold	●
note	RAL 9005 black   RAL 9016 white   shipped assembled								
integrated driver	driver box with 1 x driver Superslim 60W Dali2/Push Dali (220/240V)								
customizations	lumen output, finish								

CE UK CA IP40

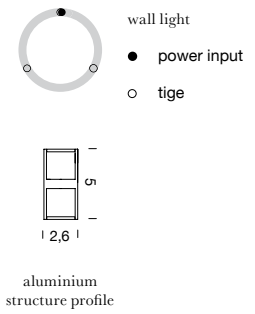
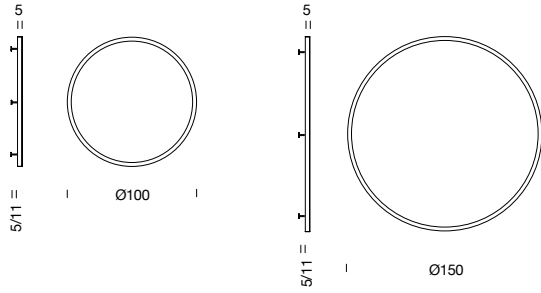

## ZIRKOL CIRCLE WALL 1m | DALI

CCT	max power	source	voltage	lum. flux	CRI	switching	code	finish
2700K	45W	LED strip	24V	2616lm	90	DALI	BZRC4210G15DNE	black ●
3000K	45W	LED strip	24V	2769lm	90	DALI	BZRC4210G15WNE	black ●
4000K	45W	LED strip	24V	3077lm	90	DALI	BZRC4210G15NNE	black ●
note	remote driver   RAL 9005 black   shipped assembled   indirect light emission							
included	1 x driver 60W (220/240V)   1 x dimmer DALI   3 x tige 5 cm   3 x tige 11 cm   1 x electrical cable 50cm							
customizations	external electrical cable   optional accessories on p.98-97   custom features on p.15							

CE UK CA IP40

## ZIRKOL CIRCLE WALL 1,5m | DALI

CCT	max power	source	voltage	lum. flux	CRI	switching	code	finish
2700K	68W	LED strip	24V	3923lm	90	DALI	BZRC4215G15DNE	black ●
3000K	68W	LED strip	24V	4154lm	90	DALI	BZRC4215G15WNE	black ●
4000K	68W	LED strip	24V	4616lm	90	DALI	BZRC4215G15NNE	black ●
note	remote driver   RAL 9005 black   shipped assembled   indirect light emission							
included	1 x driver 75W (110/240V)   1 x dimmer DALI   3 x tige 5 cm   3 x tige 11 cm   1 x electrical cable 50cm							
customizations	external electrical cable   optional accessories on p.98-97   custom features on p.15							

CE UK CA IP40



Zirkol Circle Wall, black.  
Private residence, Milan

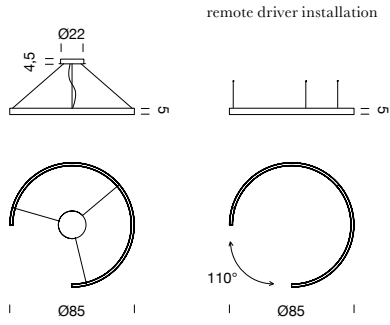

remote driver installation

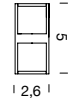
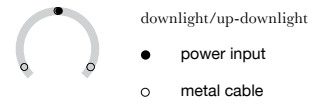

aluminium structure profile

## ZIRKOL GAP 0,85m | DALI

### DOWNLIGHT

CCT	max power	source	voltage	lum. flux	CRI	switching	code	finish	
2700K	26W	LED strip	24V	1500lm	90	DALI	BZRG1608G15DNE	white ○	
2700K	26W	LED strip	24V	1500lm	90	DALI	BZRG1608G15DBO	black ●	
2700K	26W	LED strip	24V	1500lm	90	DALI	BZRG1608G15DOR	gold ●	
3000K	26W	LED strip	24V	1650lm	90	DALI	BZRG1608G15WNE	white ○	
3000K	26W	LED strip	24V	1650lm	90	DALI	BZRG1608G15WBO	black ●	
3000K	26W	LED strip	24V	1650lm	90	DALI	BZRG1608G15WOR	gold ●	
4000K	26W	LED strip	24V	1770lm	90	DALI	BZRG1608G15NNE	white ○	
4000K	26W	LED strip	24V	1770lm	90	DALI	BZRG1608G15NBO	black ●	
4000K	26W	LED strip	24V	1770lm	90	DALI	BZRG1608G15NOR	gold ●	
note	RAL 9005 black   RAL 9016 white   shipped assembled								
included	round canopy with 1 x driver 75W (110/240V)   1 x dimmer DALI   1 x electrical cable 4m   3 x adjustable metal cable (length from 3m to 0,5m) ceiling attachment included								
customizations	external electrical cable   optional accessories on p.98-97   custom features on p.15								



### UP-DOWNLIGHT

CCT	max power	source	voltage	lum. flux	CRI	switching	code	finish	
2700K	45W	LED strip	24V	3000lm	90	DALI	BZRG1708G15DBO	white ○	
2700K	45W	LED strip	24V	3000lm	90	DALI	BZRG1708G15DNE	black ●	
2700K	45W	LED strip	24V	3000lm	90	DALI	BZRG1708G15DOR	gold ●	
3000K	45W	LED strip	24V	3300lm	90	DALI	BZRG1708G15WBO	white ○	
3000K	45W	LED strip	24V	3300lm	90	DALI	BZRG1708G15WNE	black ●	
3000K	45W	LED strip	24V	3300lm	90	DALI	BZRG1708G15WOR	gold ●	
4000K	45W	LED strip	24V	3540m	90	DALI	BZRG1708G15NBO	white ○	
4000K	45W	LED strip	24V	3540m	90	DALI	BZRG1708G15NNE	black ●	
4000K	45W	LED strip	24V	3540m	90	DALI	BZRG1708G15NOR	gold ●	
note	RAL 9005 black   RAL 9016 white   shipped assembled								
included	round canopy with 1 x driver 75W (110/240V)   1 x dimmer DALI   1 x electrical cable 4m   3 x adjustable metal cable (length from 3m to 0,5m)   ceiling attachment included								
customizations	external electrical cable   optional accessories on p.98-97   custom features on p.15								





## ZIRKOL GAP 1m | DALI

### DOWNLIGHT

CCT	max power	source	voltage	lum. flux	CRI	switching	code	finish
2700K	26W	LED strip	24V	1962lm	90	DALI	BZRG1610G15DBO	white ○
2700K	26W	LED strip	24V	1962lm	90	DALI	BZRG1610G15DNE	black ●
2700K	26W	LED strip	24V	1962lm	90	DALI	BZRG1610G15DOR	gold ●
3000K	26W	LED strip	24V	2077lm	90	DALI	BZRG1610G15WBO	white ○
3000K	26W	LED strip	24V	2077lm	90	DALI	BZRG1610G15WNE	black ●
3000K	26W	LED strip	24V	2077lm	90	DALI	BZRG1610G15WOR	gold ●
4000K	26W	LED strip	24V	2308lm	90	DALI	BZRG1610G15NBO	white ○
4000K	26W	LED strip	24V	2308lm	90	DALI	BZRG1610G15NNE	black ●
4000K	26W	LED strip	24V	2308lm	90	DALI	BZRG1610G15NOR	gold ●
note	RAL 9005 black   RAL 9016 white   shipped assembled							
included	round canopy with 1 x driver 75W (110/240V)   1 x dimmer DALI   1 x electrical cable 4m   3 x adjustable metal cable (length from 3m to 0,5m)   ceiling attachment included							
customizations	external electrical cable   optional accessories on p.98-97   custom features on p.15							



### UP-DOWNLIGHT

CCT	max power	source	voltage	lum. flux	CRI	switching	code	finish
2700K	68W	LED strip	24V	3923lm	90	DALI	BZRG1710G15DBO	white ○
2700K	68W	LED strip	24V	3923lm	90	DALI	BZRG1710G15DNE	black ●
2700K	68W	LED strip	24V	3923lm	90	DALI	BZRG1710G15DOR	gold ●
3000K	68W	LED strip	24V	4154lm	90	DALI	BZRG1710G15WBO	white ○
3000K	68W	LED strip	24V	4154lm	90	DALI	BZRG1710G15WNE	black ●
3000K	68W	LED strip	24V	4154lm	90	DALI	BZRG1710G15WOR	gold ●
4000K	68W	LED strip	24V	4615lm	90	DALI	BZRG1710G15NBO	white ○
4000K	68W	LED strip	24V	4615lm	90	DALI	BZRG1710G15NNE	black ●
4000K	68W	LED strip	24V	4615lm	90	DALI	BZRG1710G15NOR	gold ●
note	RAL 9005 black   RAL 9016 white   shipped assembled							
included	round canopy with 1 x driver 75W (110/240V)   1 x dimmer DALI   1 x electrical cable 4m   3 x adjustable metal cable (length from 3m to 0,5m)   ceiling attachment included							
customizations	external electrical cable   optional accessories on p.98-97   custom features on p.15							





## ZIRKOL GAP 1,5m | DALI

### DOWNLIGHT

CCT	max power	source	voltage	lum. flux	CRI	switching	code	finish	
2700K	50W	LED strip	24V	2942lm	90	DALI	BZRG1615G15DBO	white ○	
2700K	50W	LED strip	24V	2942lm	90	DALI	BZRG1615G15DNE	black ●	
2700K	50W	LED strip	24V	2942lm	90	DALI	BZRG1615G15DOR	gold ●	
3000K	50W	LED strip	24V	3115lm	90	DALI	BZRG1615G15WBO	white ○	
3000K	50W	LED strip	24V	3115lm	90	DALI	BZRG1615G15WNE	black ●	
3000K	50W	LED strip	24V	3115lm	90	DALI	BZRG1615G15WOR	gold ●	
4000K	50W	LED strip	24V	3462lm	90	DALI	BZRG1615G15NBO	white ○	
4000K	50W	LED strip	24V	3462lm	90	DALI	BZRG1615G15NNE	black ●	
4000K	50W	LED strip	24V	3462lm	90	DALI	BZRG1615G15NOR	gold ●	
note	RAL 9005 black   RAL 9016 white   shipped assembled								
included	round canopy with 1 x driver 75W (110/240V)   1 x dimmer DALI   1 x electrical cable 4m   3 x adjustable metal cable (length from 3m to 0,5m)   ceiling attachment included								
customizations	external electrical cable   optional accessories on p.98-97   custom features on p.15								

CE UK CA IP40

### UP-DOWNLIGHT

CCT	max power	source	voltage	lum. flux	CRI	switching	code	finish	
2700K	100W	LED strip	24V	5885lm	90	DALI	BZRG1715G15DBO	white ○	
2700K	100W	LED strip	24V	5885lm	90	DALI	BZRG1715G15DNE	black ●	
2700K	100W	LED strip	24V	5885lm	90	DALI	BZRG1715G15DOR	gold ●	
3000K	100W	LED strip	24V	6231lm	90	DALI	BZRG1715G15WBO	white ○	
3000K	100W	LED strip	24V	6231lm	90	DALI	BZRG1715G15WNE	black ●	
3000K	100W	LED strip	24V	6231lm	90	DALI	BZRG1715G15WOR	gold ●	
4000K	100W	LED strip	24V	6924lm	90	DALI	BZRG1715G15NBO	white ○	
4000K	100W	LED strip	24V	6924lm	90	DALI	BZRG1715G15NNE	black ●	
4000K	100W	LED strip	24V	6924lm	90	DALI	BZRG1715G15NOR	gold ●	
note	RAL 9005 black   RAL 9016 white   shipped assembled								
included	round canopy with 1 x driver 100W (110/240V)   1 x dimmer DALI   1 x electrical cable 4m   3 x adjustable metal cable (length from 3m to 0,5m)   ceiling attachment included								
customizations	external electrical cable   optional accessories on p.98-97   custom features on p.15								

CE UK CA IP40

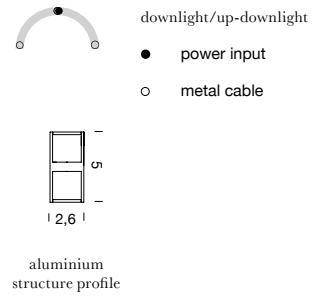
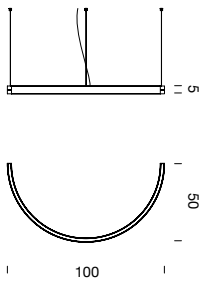

## ZIRKOL ROUND 1m | DALI

### DOWNLIGHT

CCT	max power	source	voltage	lum. flux	CRI	switching	code	finish
2700K	22,5W	LED strip	24V	1308lm	90	DALI	BZRR1610G15DBO	white ○
2700K	22,5W	LED strip	24V	1308lm	90	DALI	BZRR1610G15DNE	black ●
2700K	22,5W	LED strip	24V	1308lm	90	DALI	BZRR1610G15DOR	gold ●
3000K	22,5W	LED strip	24V	1384lm	90	DALI	BZRR1610G15WBO	white ○
3000K	22,5W	LED strip	24V	1384lm	90	DALI	BZRR1610G15WNE	black ●
3000K	22,5W	LED strip	24V	1384lm	90	DALI	BZRR1610G15WOR	gold ●
4000K	22,5W	LED strip	24V	1538lm	90	DALI	BZRR1610G15NBO	white ○
4000K	22,5W	LED strip	24V	1538lm	90	DALI	BZRR1610G15NNE	black ●
4000K	22,5W	LED strip	24V	1538lm	90	DALI	BZRR1610G15NOR	gold ●
note	RAL 9005 black   RAL 9016 white   shipped assembled							
included	remote driver 60W (220/240V)   1 x dimmer DALI   1 x electrical cable 4m   3 x adjustable metal cable (length from 3m to 0,5m)   ceiling attachment included							
customizations	external electrical cable   optional accessories on p.98-97   custom features on p.15							



### UP-DOWNLIGHT

CCT	max power	source	voltage	lum. flux	CRI	switching	code	finish
2700K	45W	LED strip	24V	2615lm	90	DALI	BZRR1710G15DBO	white ○
2700K	45W	LED strip	24V	2615lm	90	DALI	BZRR1710G15DNE	black ●
2700K	45W	LED strip	24V	2615lm	90	DALI	BZRR1710G15DOR	gold ●
3000K	45W	LED strip	24V	2769lm	90	DALI	BZRR1710G15WBO	white ○
3000K	45W	LED strip	24V	2769lm	90	DALI	BZRR1710G15WNE	black ●
3000K	45W	LED strip	24V	2769lm	90	DALI	BZRR1710G15WOR	gold ●
4000K	45W	LED strip	24V	3077lm	90	DALI	BZRR1710G15NBO	white ○
4000K	45W	LED strip	24V	3077lm	90	DALI	BZRR1710G15NNE	black ●
4000K	45W	LED strip	24V	3077lm	90	DALI	BZRR1710G15NOR	gold ●
note	RAL 9005 black   RAL 9016 white   shipped assembled							
included	remote driver 60W (220/240V)   1 x dimmer DALI   1 x electrical cable 4m   3 x adjustable metal cable (length from 3m to 0,5m)   ceiling attachment included							
customizations	external electrical cable   optional accessories on p.98-97   custom features on p.15							





Zirkol Round, gold.  
Private project, London



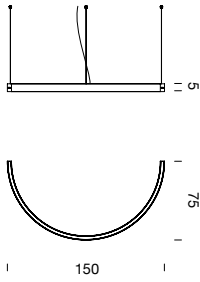

downlight/up-downlight

● power input

○ metal cable

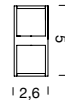

aluminium structure profile

## ZIRKOL ROUND 1,5m | DALI

### DOWNLIGHT

CCT	max power	source	voltage	lum. flux	CRI	switching	code	finish	
2700K	34W	LED strip	24V	1961lm	90	DALI	BZRR1615G15DBO	white	○
2700K	34W	LED strip	24V	1961lm	90	DALI	BZRR1615G15DNE	black	●
2700K	34W	LED strip	24V	1961lm	90	DALI	BZRR1615G15DOR	gold	●
3000K	34W	LED strip	24V	2077lm	90	DALI	BZRR1615G15WBO	white	○
3000K	34W	LED strip	24V	2077lm	90	DALI	BZRR1615G15WNE	black	●
3000K	34W	LED strip	24V	2077lm	90	DALI	BZRR1615G15WOR	gold	●
4000K	34W	LED strip	24V	23068lm	90	DALI	BZRR1615G15NBO	white	○
4000K	34W	LED strip	24V	23068lm	90	DALI	BZRR1615G15NNE	black	●
4000K	34W	LED strip	24V	23068lm	90	DALI	BZRR1615G15NOR	gold	●
note	RAL 9005 black   RAL 9016 white   shipped assembled								
included	remote driver 60W (220/240V)   1 x dimmer DALI   1 x electrical cable 4m   3 x adjustable metal cable (length from 3m to 0,5m)   ceiling attachment included								
customizations	external electrical cable   optional accessories on p.98-97   custom features on p.15								



### UP-DOWNLIGHT

CCT	max power	source	voltage	lum. flux	CRI	switching	code	finish	
2700K	68W	LED strip	24V	3923lm	90	DALI	BZRR1715G15DBO	white	○
2700K	68W	LED strip	24V	3923lm	90	DALI	BZRR1715G15DNE	black	●
2700K	68W	LED strip	24V	3923lm	90	DALI	BZRR1715G15DOR	gold	●
3000K	68W	LED strip	24V	4154lm	90	DALI	BZRR1715G15WBO	white	○
3000K	68W	LED strip	24V	4154lm	90	DALI	BZRR1715G15WNE	black	●
3000K	68W	LED strip	24V	4154lm	90	DALI	BZRR1715G15WOR	gold	●
4000K	68W	LED strip	24V	4616lm	90	DALI	BZRR1715G15NBO	white	○
4000K	68W	LED strip	24V	4616lm	90	DALI	BZRR1715G15NNE	black	●
4000K	68W	LED strip	24V	4616lm	90	DALI	BZRR1715G15NOR	gold	●
note	RAL 9005 black   RAL 9016 white   shipped assembled								
included	remote driver 75W (110/240V)   1 x dimmer DALI   1 x electrical cable 4m   3 x adjustable metal cable (length from 3m to 0,5m)   ceiling attachment included								
customizations	external electrical cable   optional accessories on p.98-97   custom features on p.15								



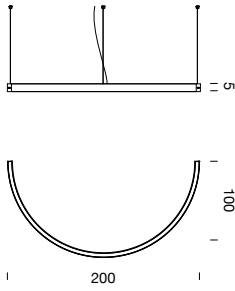

downlight/up-downlight

● power input

○ metal cable

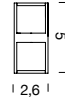
aluminium  
structure profile

## ZIRKOL ROUND 2m | DALI

### DOWNLIGHT

CCT	max power	source	voltage	lum. flux	CRI	switching	code	finish	
2700K	45W	LED strip	24V	2630lm	90	DALI	BZRR1620G15DBO	white	○
2700K	45W	LED strip	24V	2630lm	90	DALI	BZRR1620G15DNE	black	●
2700K	45W	LED strip	24V	2630lm	90	DALI	BZRR1620G15DOR	gold	●
3000K	45W	LED strip	24V	2769lm	90	DALI	BZRR1620G15WBO	white	○
3000K	45W	LED strip	24V	2769lm	90	DALI	BZRR1620G15WNE	black	●
3000K	45W	LED strip	24V	2769lm	90	DALI	BZRR1620G15WOR	gold	●
4000K	45W	LED strip	24V	3077lm	90	DALI	BZRR1620G15NBO	white	○
4000K	45W	LED strip	24V	3077lm	90	DALI	BZRR1620G15NNE	black	●
4000K	45W	LED strip	24V	3077lm	90	DALI	BZRR1620G15NOR	gold	●
note	RAL 9005 black   RAL 9016 white   shipped assembled								
included	remote driver 60W (220/240V)   1 x dimmer DALI   1 x electrical cable 4m   3 x adjustable metal cable (length from 3m to 0,5m)   ceiling attachment included								
customizations	external electrical cable   optional accessories on p.98-97   custom features on p.15								

CE UK CA IP40

### UP-DOWNLIGHT

CCT	max power	source	voltage	lum. flux	CRI	switching	code	finish	
2700K	90W	LED strip	24V	5250lm	90	DALI	BZRR1720G15DBO	white	○
2700K	90W	LED strip	24V	5250lm	90	DALI	BZRR1720G15DNE	black	●
2700K	90W	LED strip	24V	5250lm	90	DALI	BZRR1720G15DOR	gold	●
3000K	90W	LED strip	24V	5539lm	90	DALI	BZRR1720G15WBO	white	○
3000K	90W	LED strip	24V	5539lm	90	DALI	BZRR1720G15WNE	black	●
3000K	90W	LED strip	24V	5539lm	90	DALI	BZRR1720G15WOR	gold	●
4000K	90W	LED strip	24V	6154lm	90	DALI	BZRR1720G15NBO	white	○
4000K	90W	LED strip	24V	6154lm	90	DALI	BZRR1720G15NNE	black	●
4000K	90W	LED strip	24V	6154lm	90	DALI	BZRR1720G15NOR	gold	●
note	RAL 9005 black   RAL 9016 white   shipped assembled								
included	remote driver 100W (110/240V)   1 x dimmer DALI   1 x electrical cable 4m   3 x adjustable metal cable (length from 3m to 0,5m)   ceiling attachment included								
customizations	external electrical cable   optional accessories on p.98-97   custom features on p.15								

CE UK CA IP40

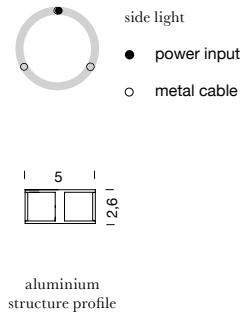
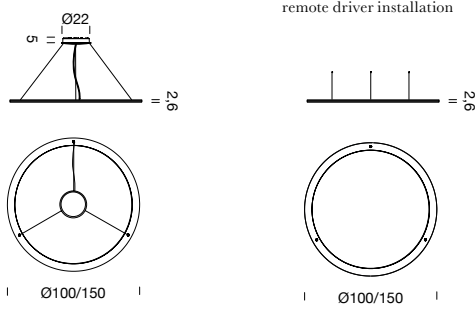

## ZIRKOL SIDE 1m | DALI

### INSIDE-OUTSIDE LIGHT

CCT	max power	source	voltage	lum. flux	CRI	switching	code	finish
2700K	90W	LED strip	24V	5231lm	90	DALI	BZRS1710G15DBO	white ○
2700K	90W	LED strip	24V	5231lm	90	DALI	BZRS1710G15DNE	black ●
3000K	90W	LED strip	24V	5539lm	90	DALI	BZRS1710G15WBO	white ○
3000K	90W	LED strip	24V	5539lm	90	DALI	BZRS1710G15WNE	black ●
4000K	90W	LED strip	24V	56154m	90	DALI	BZRS1710G15NBO	white ○
4000K	90W	LED strip	24V	6154lm	90	DALI	BZRS1710G15NNE	black ●
note	RAL 9005 black   RAL 9016 white   shipped assembled							
included	round canopy with 1 x driver 100W (110/240V)   1 x dimmer DALI   1 x electrical cable 4m   3 x adjustable metal cable (length from 3m to 0,5m)							
customizations	external electrical cable   optional accessories on p.98-97   custom features on p.15							

CE UK CA IP40

## ZIRKOL SIDE 1,5m | DALI

### INSIDE-OUTSIDE LIGHT

CCT	max power	source	voltage	lum. flux	CRI	switching	code	finish
2700K	136W	LED strip	24V	7847lm	90	DALI	BZRS1715G15DBO	white ○
2700K	136W	LED strip	24V	7847lm	90	DALI	BZRS1715G15DNE	black ●
3000K	136W	LED strip	24V	8308lm	90	DALI	BZRS1715G15WBO	white ○
3000K	136W	LED strip	24V	8308lm	90	DALI	BZRS1715G15WNE	black ●
4000K	136W	LED strip	24V	9232lm	90	DALI	BZRS1715G15NBO	white ○
4000K	136W	LED strip	24V	9232lm	90	DALI	BZRS1715G15NNE	black ●
note	RAL 9005 black   RAL 9016 white   shipped assembled							
included	round canopy with 1 x driver 150W (220/240V)   1 x dimmer DALI   1 x electrical cable 4m   3 x adjustable metal cable (length from 3m to 0,5m)							
customizations	external electrical cable   optional accessories on p.98-97   custom features on p.15							

CE UK CA IP40



side light emission

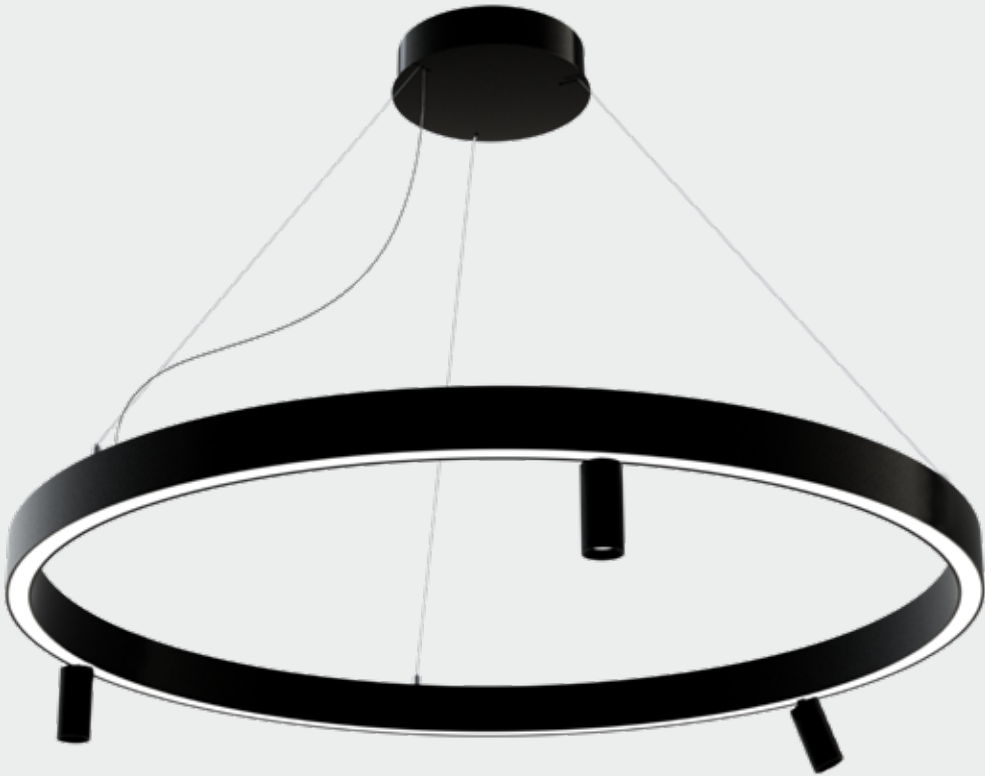

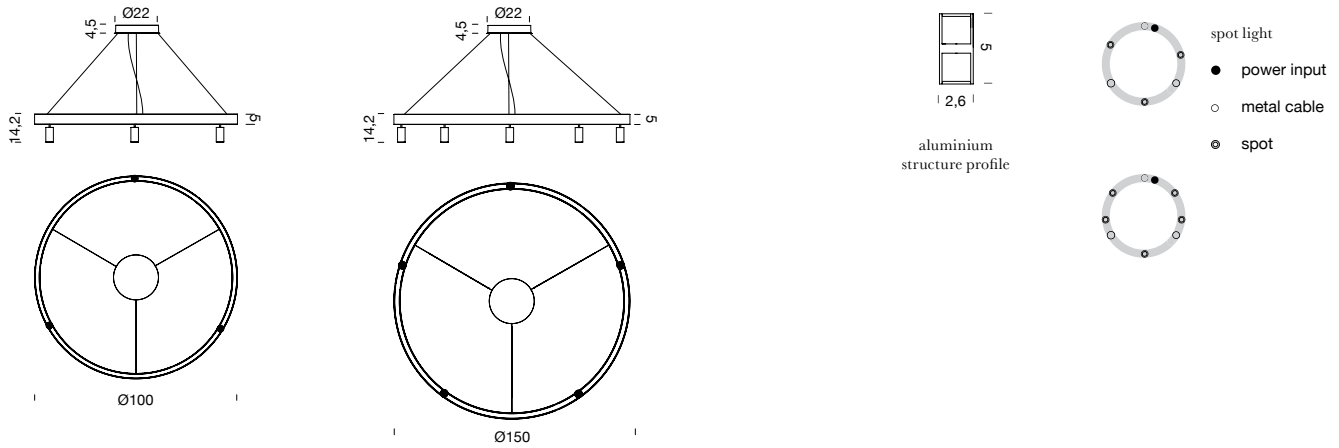

## ZIRKOL SPOT 1m | DALI

### DOWNLIGHT

CCT	max power	source	voltage	lum. flux	CRI	switching	code	finish	
2700K	60W	LED strip	24V	3955lm	90	DALI	BZRCF610G15DBO	white ○	
2700K	60W	LED strip	24V	3955lm	90	DALI	BZRCF610G15DNE	black ●	
2700K	60W	LED strip	24V	3955lm	90	DALI	BZRCF610G15DOR	gold ●	
3000K	60W	LED strip	24V	4393lm	90	DALI	BZRCF610G15WBO	white ○	
3000K	60W	LED strip	24V	4393lm	90	DALI	BZRCF610G15WNE	black ●	
3000K	60W	LED strip	24V	4393lm	90	DALI	BZRCF610G15WOR	gold ●	
note	RAL 9005 black   RAL 9016 white   shipped assembled   *396lm for a single spot   spots diameter 3,7cm / spot power consumption 5W								
included	round canopy with 1 x driver 75W (110/24V)   1 x dimmer DALI   1 x electrical cable 4m   3x adjustable spots up to 90° black/white/gold   3 x adjustable metal cable (length from 3m to 0,5m) ceiling attachment included								
customizations	external electrical cable   optional accessories on p.98-97   custom features on p.15								

CE UK CA IP40

## ZIRKOL SPOT 1,5m | DALI

### DOWNLIGHT

CCT	max power	source	voltage	lum. flux	CRI	switching	code	finish	
2700K	93W	LED strip	24V	5515lm	90	DALI	BZRCF615G15DBO	white ○	
2700K	93W	LED strip	24V	5515lm	90	DALI	BZRCF615G15DNE	black ●	
2700K	93W	LED strip	24V	5515lm	90	DALI	BZRCF615G15DOR	gold ●	
3000K	93W	LED strip	24V	6130lm	90	DALI	BZRCF615G15WBO	white ○	
3000K	93W	LED strip	24V	6130lm	90	DALI	BZRCF615G15WNE	black ●	
3000K	93W	LED strip	24V	6130lm	90	DALI	BZRCF615G15WOR	gold ●	
note	RAL 9005 black   RAL 9016 white   shipped assembled   *396lm for a single spot   spots diameter 3,7cm / spot power consumption 5W								
included	round canopy with 1 x driver 100W (110/240V)   1 x dimmer DALI   1 x electrical cable 4m   3x adjustable spots up to 90° black/white/gold   3 x adjustable metal cable (length from 3m to 0,5m) ceiling attachment included								
customizations	external electrical cable   optional accessories on p.98-97   custom features on p.15								

CE UK CA IP40



grey panel standard



blue navy panel on demand



deep green panel on demand

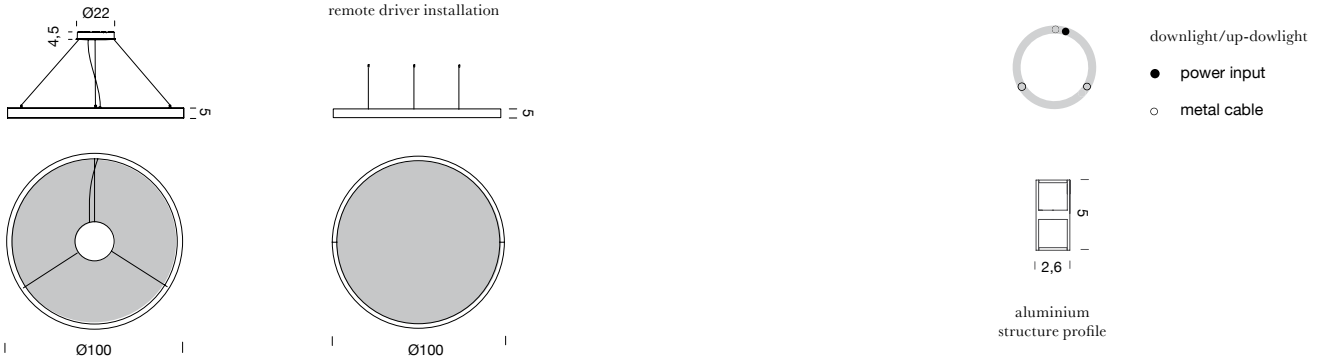

## ZIRKOL ACOUSTIC 1m | DALI

### DOWNLIGHT

CCT	max power	source	voltage	lum. flux	CRI	switching	panel	code	finish	
2700K	45W	LED strip	24V	2616lm	90	DALI	grey	BZAC1610G15DBG	white ○	
2700K	45W	LED strip	24V	2616lm	90	DALI	grey	BZAC1610G15DNG	black ●	
3000K	45W	LED strip	24V	2769lm	90	DALI	grey	BZAC1610G15WBG	white ○	
3000K	45W	LED strip	24V	2769lm	90	DALI	grey	BZAC1610G15WNG	black ●	
4000K	45W	LED strip	24V	3077lm	90	DALI	grey	BZAC1610G15NBS	white ○	
4000K	45W	LED strip	24V	3077lm	90	DALI	grey	BZAC1610G15NNG	black ●	
note	RAL 9005 black   RAL 9016 white   shipped assembled									
included	round canopy with 1 x driver 75W (110/24V)   1 x dimmer DALI   1 x electrical cable 4m   3 x adjustable metal cable (length from 3m to 0,5m) ceiling attachment included   Grey sound-absorbing panel 100% polyester FR									
customizations	blue navy or deep green panels available on demand, external electrical cable   optional accessories on p.98-97   custom features on p.15									

CE UK CA IP40

## ZIRKOL ACOUSTIC 1m | DALI

### UP-DOWNLIGHT

CCT	max power	source	voltage	lum. flux	CRI	switching	panel	code	finish	
2700K	90W	LED strip	24V	5231lm	90	DALI	grey	BZAC1710G15DBG	white ○	
2700K	90W	LED strip	24V	5231lm	90	DALI	grey	BZAC1710G15DNG	black ●	
3000K	90W	LED strip	24V	5539lm	90	DALI	grey	BZAC1710G15NBS	white ○	
3000K	90W	LED strip	24V	5539lm	90	DALI	grey	BZAC1710G15NNG	black ●	
4000K	90W	LED strip	24V	6154lm	90	DALI	grey	BZAC1710G15WBG	white ○	
4000K	90W	LED strip	24V	6154lm	90	DALI	grey	BZAC1710G15WNG	black ●	
note	RAL 9005 black   RAL 9016 white   shipped assembled									
included	round canopy with 1 x driver 100W (110/240V)   1 x dimmer DALI   1 x electrical cable 4m   3 x adjustable metal cable (length from 3m to 0,5m) ceiling attachment included   Grey sound-absorbing panel 100% polyester FR									
customizations	blue navy or deep green panels available on demand, external electrical cable   optional accessories on p.98-97   custom features on p.15									

CE UK CA IP40

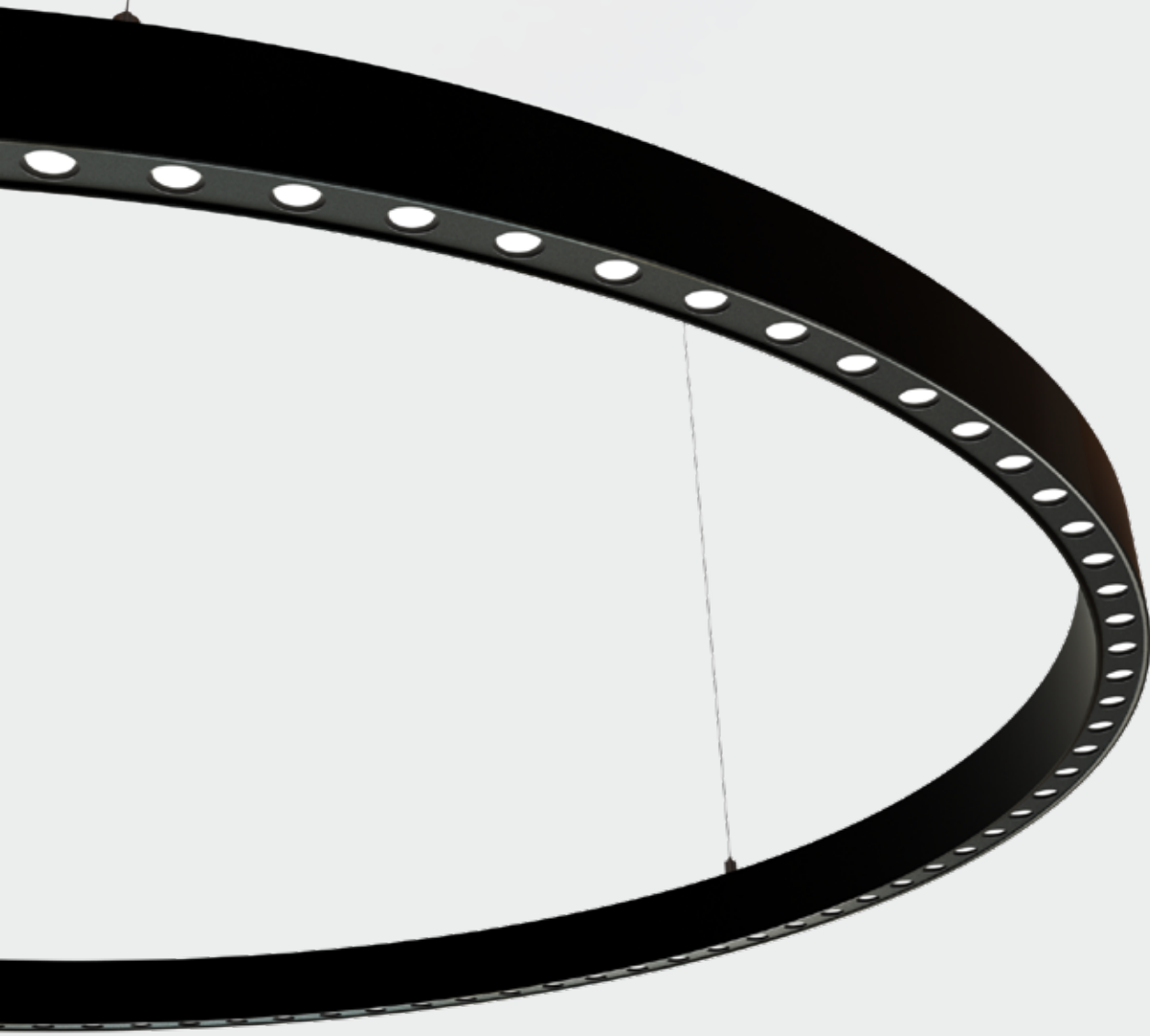



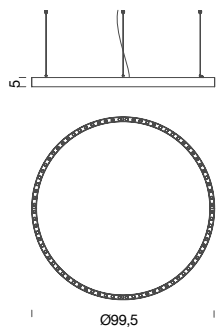

downlight  
 ● power input  
 ○ metal cable



aluminium  
structure profile

## ZIRKOL CIRCLE UGR 1M | DALI

### DOWNLIGHT

CCT	max power	source	voltage	lum. flux	optic	CRI	switching	code	finish
2700K	59W	flex LED strip 30°	24VDC	3505lm	30°	90	DALI	BZRC1610I42DNE	black ●
3000K	59W	flex LED strip 30°	24VDC	3894lm	30°	90	DALI	BZRC1610I42WNE	black ●
4000K	59W	flex LED strip 30°	24VDC	4327lm	30°	90	DALI	BZRC1610I42NNE	black ●

note RAL 9005 black | shipped assembled

included 1 x driver 75W (110/240V) | 1 x dimmer DALI | 1 x electrical cable 4m | 3 x adjustable metal cable (length from 3m to 0,5m) ceiling attachment included

customizations external electrical cable | optional accessories on p.98-97 | custom features on p.15

CE UK CA IP40 UGR<19

### UP-DOWNLIGHT

CCT	max power	source	voltage	lum. flux	optic	CRI	switching	code	finish
2700K	104W	flex LED strip 30°+ LED strip	24VDC	5646lm	30°+ diffused	90	DALI	BZRC1710I42DNE	black ●
3000K	104W	flex LED strip 30°+ LED strip	24VDC	6274lm	30°+ diffused	90	DALI	BZRC1710I42WNE	black ●
4000K	104W	flex LED strip 30°+ LED strip	24VDC	6971lm	30°+ diffused	90	DALI	BZRC1710I42NNE	black ●

note RAL 9005 black | shipped assembled

included 1 x driver 150W (110/240V) | 1 x dimmer DALI | 1 x electrical cable 4m | 3 x adjustable metal cable (length from 3m to 0,5m) ceiling attachment included

customizations external electrical cable | optional accessories on p.98-97 | custom features on p.15

CE UK CA IP40 UGR<19



anti-glare optics



UGR<19

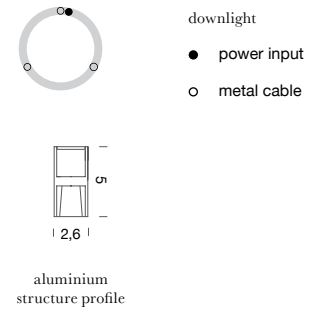
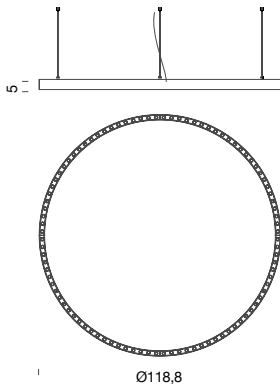

## ZIRKOL CIRCLE UGR 1,2M | DALI

### DOWNLIGHT

CCT	max power	source	voltage	lum. flux	optic	CRI	switching	code	finish
2700K	70W	flex LED strip 30°	24VDC	4130lm	30°	90	DALI	BZRC1612I42DNE	black ●
3000K	70W	flex LED strip 30°	24VDC	4620lm	30°	90	DALI	BZRC1612I42WNE	black ●
4000K	70W	flex LED strip 30°	24VDC	5110lm	30°	90	DALI	BZRC1612I42NNE	black ●
note	RAL 9005 black   shipped assembled								
included	1 x driver 75W (110/240V)   1 x dimmer DALI   1 x electrical cable 4m   3 x adjustable metal cable (length from 3m to 0,5m) ceiling attachment included								
customizations	external electrical cable   optional accessories on p.98-97   custom features on p.15								

CE UK CA IP40 UGR<19

### UP-DOWNLIGHT

CCT	max power	source	voltage	lum. flux	optic	CRI	switching	code	finish
2700K	124W	flex LED strip 30°+ LED strip	24VDC	6696lm	30°+ diffused	90	DALI	BZRC1712I42DNE	black ●
3000K	124W	flex LED strip 30°+ LED strip	24VDC	7440lm	30°+ diffused	90	DALI	BZRC1712I42WNE	black ●
4000K	124W	flex LED strip 30°+ LED strip	24VDC	8308lm	30°+ diffused	90	DALI	BZRC1712I42NNE	black ●
note	RAL 9005 black   shipped assembled								
included	1 x driver 150W (110/240V)   1 x dimmer DALI   1 x electrical cable 4m   3 x adjustable metal cable (length from 3m to 0,5m) ceiling attachment included								
customizations	external electrical cable   optional accessories on p.98-97   custom features on p.15								

CE UK CA IP40 UGR<19



anti-glare optics



UGR<19

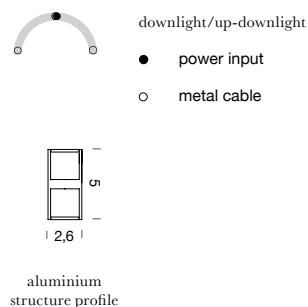
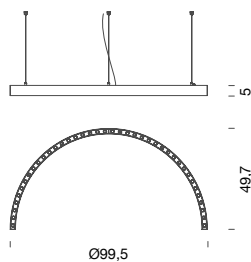

## ZIRKOL ROUND UGR 1M | DALI

### DOWNLIGHT

CCT	max power	source	voltage	lum. flux	optic	CRI	switching	code	finish
2700K	29,5W	flex LED strip 30°	24VDC	1753lm	30°	90	DALI	BZRR1610I42DNE	black ●
3000K	29,5W	flex LED strip 30°	24VDC	1947lm	30°	90	DALI	BZRR1610I42WNE	black ●
4000K	29,5W	flex LED strip 30°	24VDC	2163lm	30°	90	DALI	BZRR1610I42NNE	black ●
note	RAL 9005 black   shipped assembled								
included	1 x driver 75W (110/240V)   1 x dimmer DALI   1 x electrical cable 4m   3 x adjustable metal cable (length from 3m to 0,5m) ceiling attachment included								
customizations	external electrical cable   optional accessories on p.98-97   custom features on p.15								

CE UK CA IP40 UGR<19

### UP-DOWNLIGHT

CCT	max power	source	voltage	lum. flux	optic	CRI	switching	code	finish
2700K	52W	flex LED strip 30°+ LED strip	24VDC	2823lm	30°+ diffused	90	DALI	BZRR1710I42DNE	black ●
3000K	52W	flex LED strip 30°+ LED strip	24VDC	3137lm	30°+ diffused	90	DALI	BZRR1710I42WNE	black ●
4000K	52W	flex LED strip 30°+ LED strip	24VDC	3486lm	30°+ diffused	90	DALI	BZRR1710I42NNE	black ●
note	RAL 9005 black   shipped assembled								
included	1 x driver 75W (110/240V)   1 x dimmer DALI   1 x electrical cable 4m   3 x adjustable metal cable (length from 3m to 0,5m) ceiling attachment included								
customizations	external electrical cable   optional accessories on p.98-97   custom features on p.15								

CE UK CA IP40 UGR<19



anti-glare optics

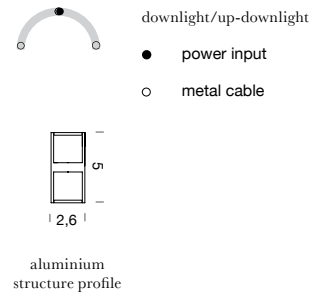
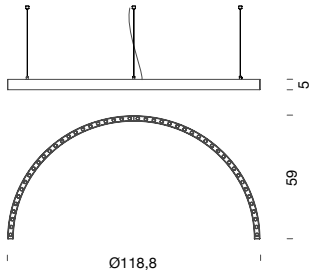

## ZIRKOL ROUND UGR 1,2M | DALI

### DOWNLIGHT

CCT	max power	source	voltage	lum. flux	optic	CRI	switching	code	finish
2700K	35W	flex LED strip 30°	24VDC	2565lm	30°	90	DALI	BZRR1612I42DNE	black ●
3000K	35W	flex LED strip 30°	24VDC	2310lm	30°	90	DALI	BZRR1612I42WNE	black ●
4000K	35W	flex LED strip 30°	24VDC	2555lm	30°	90	DALI	BZRR1612I42NNE	black ●
note	RAL 9005 black   shipped assembled								
included	1 x driver 75W (110/240V)   1 x dimmer DALI   1 x electrical cable 4m   3 x adjustable metal cable (length from 3m to 0,5m) ceiling attachment included								
customizations	external electrical cable   optional accessories on p.98-97   custom features on p.15								

CE UK CA IP40 UGR<19

### UP-DOWNLIGHT

CCT	max power	source	voltage	lum. flux	optic	CRI	switching	code	finish
2700K	62W	flex LED strip 30°+ LED strip	24VDC	3348lm	30°+ diffused	90	DALI	BZRR1712I42DNE	black ●
3000K	62W	flex LED strip 30°+ LED strip	24VDC	3720lm	30°+ diffused	90	DALI	BZRR1712I42WNE	black ●
4000K	62W	flex LED strip 30°+ LED strip	24VDC	4154lm	30°+ diffused	90	DALI	BZRR1712I42NNE	black ●
note	RAL 9005 black   shipped assembled								
included	1 x driver 75W (110/240V)   1 x dimmer DALI   1 x electrical cable 4m   3 x adjustable metal cable (length from 3m to 0,5m) ceiling attachment included								
customizations	external electrical cable   optional accessories on p.98-97   custom features on p.15								

CE UK CA IP40 UGR<19



anti-glare optics

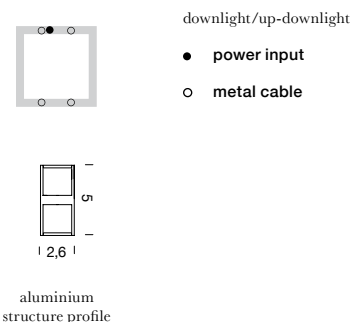
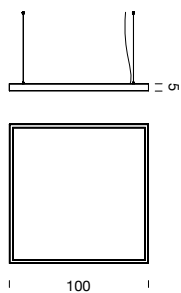

## ZIRKOL SQUARE S 1m | DALI

### DOWNLIGHT

CCT	max power	source	voltage	lum. flux	CRI	switching	code	finish	
2700K	58W	LED strip	24V	3330lm	90	DALI	BZRA1610G15DBO	white	○
2700K	58W	LED strip	24V	3330lm	90	DALI	BZRA1610G15DNE	black	●
2700K	58W	LED strip	24V	3330lm	90	DALI	BZRA1610G15DOR	gold	●
3000K	58W	LED strip	24V	3525lm	90	DALI	BZRA1610G15WBO	white	○
3000K	58W	LED strip	24V	3525lm	90	DALI	BZRA1610G15WNE	black	●
3000K	58W	LED strip	24V	3525lm	90	DALI	BZRA1610G15WOR	gold	●
4000K	58W	LED strip	24V	3920lm	90	DALI	BZRA1610G15NBO	white	○
4000K	58W	LED strip	24V	3920lm	90	DALI	BZRA1610G15NNE	black	●
4000K	58W	LED strip	24V	3920lm	90	DALI	BZRA1610G15NOR	gold	●
note	RAL 9005 black   RAL 9016 white   shipped assembled								
included	remote driver 60W (220/240V)   1 x dimmer DALI   1 x electrical cable 4m   4 x adjustable metal cable (length from 3m to 0,5m)   ceiling attachment included								
customizations	external electrical cable   optional accessories on p.98-97   custom features on p.15								



### UP-DOWNLIGHT

CCT	max power	source	voltage	lum. flux	CRI	switching	code	finish	
2700K	116W	LED strip	24V	6660lm	90	DALI	BZRA1710G15DBO	white	○
2700K	116W	LED strip	24V	6660lm	90	DALI	BZRA1710G15DNE	black	●
2700K	116W	LED strip	24V	6660lm	90	DALI	BZRA1710G15DOR	gold	●
3000K	116W	LED strip	24V	7050lm	90	DALI	BZRA1710G15WBO	white	○
3000K	116W	LED strip	24V	7050lm	90	DALI	BZRA1710G15WNE	black	●
3000K	116W	LED strip	24V	7050lm	90	DALI	BZRA1710G15WOR	gold	●
4000K	116W	LED strip	24V	7840lm	90	DALI	BZRA1710G15NBO	white	○
4000K	116W	LED strip	24V	7840lm	90	DALI	BZRA1710G15NNE	black	●
4000K	116W	LED strip	24V	7840lm	90	DALI	BZRA1710G15NOR	gold	●
note	RAL 9005 black   RAL 9016 white   shipped assembled								
included	remote driver 150W (220/240V)   1 x dimmer DALI   1 x electrical cable 4m   4 x adjustable metal cable (length from 3m to 0,5m)   ceiling attachment included								
customizations	external electrical cable   optional accessories on p.98-97   custom features on p.15								



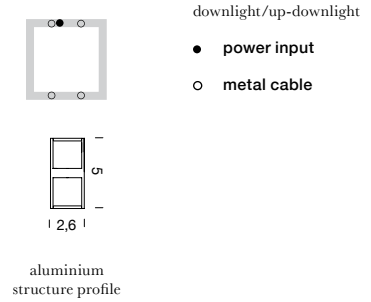
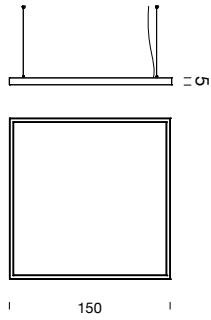

## ZIRKOL SQUARE S 1,5m | DALI

### DOWNLIGHT

CCT	max power	source	voltage	lum. flux	CRI	switching	code	finish	
2700K	87W	LED strip	24V	5000lm	90	DALI	BZRA1615G15DBO	white	○
2700K	87W	LED strip	24V	5000lm	90	DALI	BZRA1615G15DNE	black	●
2700K	87W	LED strip	24V	5000lm	90	DALI	BZRA1615G15DOR	gold	●
3000K	87W	LED strip	24V	5290lm	90	DALI	BZRA1615G15WBO	white	○
3000K	87W	LED strip	24V	5290lm	90	DALI	BZRA1615G15WNE	black	●
3000K	87W	LED strip	24V	5290lm	90	DALI	BZRA1615G15WOR	gold	●
4000K	87W	LED strip	24V	5880lm	90	DALI	BZRA1615G15NBO	white	○
4000K	87W	LED strip	24V	5880lm	90	DALI	BZRA1615G15NNE	black	●
4000K	87W	LED strip	24V	5880lm	90	DALI	BZRA1615G15NOR	gold	●
note	RAL 9005 black   RAL 9016 white   shipped assembled								
included	remote driver 100W (110/240V)   1 x dimmer DALI   1 x electrical cable 4m   4 x adjustable metal cable (length from 3m to 0,5m)   ceiling attachment included								
customizations	external electrical cable   optional accessories on p.98-97   custom features on p.15								

CE UK CA IP40

### UP-DOWNLIGHT

CCT	max power	source	voltage	lum. flux	CRI	switching	code	finish	
2700K	174W	LED strip	24V	10000lm	90	DALI	BZRA1715G15DBO	white	○
2700K	174W	LED strip	24V	10000lm	90	DALI	BZRA1715G15DNE	black	●
2700K	174W	LED strip	24V	10000lm	90	DALI	BZRA1715G15DOR	gold	●
3000K	174W	LED strip	24V	10480lm	90	DALI	BZRA1715G15WBO	white	○
3000K	174W	LED strip	24V	10480lm	90	DALI	BZRA1715G15WNE	black	●
3000K	174W	LED strip	24V	10480lm	90	DALI	BZRA1715G15WOR	gold	●
4000K	174W	LED strip	24V	11760lm	90	DALI	BZRA1715G15NBO	white	○
4000K	174W	LED strip	24V	11760lm	90	DALI	BZRA1715G15NNE	black	●
4000K	174W	LED strip	24V	11760lm	90	DALI	BZRA1715G15NOR	gold	●
note	RAL 9005 black   RAL 9016 white   shipped assembled								
included	remote driver 250W (220/240V)   1 x dimmer DALI   1 x electrical cable 4m   4 x adjustable metal cable (length from 3m to 0,5m)   ceiling attachment included								
customizations	external electrical cable   optional accessories on p.98-97   custom features on p.15								

CE UK CA IP40









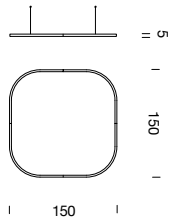

downlight/up-downlight

● power input

○ metal cable

- split

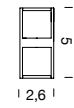
aluminium structure  
profile

## ZIRKOL SQUARE Q 1,5 x 1,5m | DALI

### DOWNLIGHT

CCT	max power	source	voltage	lum. flux	CRI	switching	code	finish	
2700K	77W	LED strip	24V	4432lm	90	DALI	BZRQ1606G15DBO	white	○
2700K	77W	LED strip	24V	4432lm	90	DALI	BZRQ1606G15DNE	black	●
2700K	77W	LED strip	24V	4432lm	90	DALI	BZRQ1606G15DOR	gold	●
3000K	77W	LED strip	24V	4692lm	90	DALI	BZRQ1606G15WBO	white	○
3000K	77W	LED strip	24V	4692lm	90	DALI	BZRQ1606G15WNE	black	●
3000K	77W	LED strip	24V	4692lm	90	DALI	BZRQ1606G15WOR	gold	●
4000K	77W	LED strip	24V	5214lm	90	DALI	BZRQ1606G15NBO	white	○
4000K	77W	LED strip	24V	5214lm	90	DALI	BZRQ1606G15NNE	black	●
4000K	77W	LED strip	24V	5214lm	90	DALI	BZRQ1606G15NOR	gold	●
note	remote driver   RAL 9005 black   RAL 9016 white   shipped assembled								
included	1 x driver 100W (110/240V)   1 x dimmer DALI   1 x electrical cable 5m   4 x adjustable metal cable length 3m (including ceiling attachment)								
optional accessory	driver box   ceiling plate for remote driver (more specification on p.98-97)								
customizations	find customizable features on p.15								

CE UK CA IP40

### UP-DOWNLIGHT

CCT	max power	source	voltage	lum. flux	CRI	switching	code	finish	
2700K	154W	LED strip	24V	8863lm	90	DALI	BZRQ1712G15DBO	white	○
2700K	154W	LED strip	24V	8863lm	90	DALI	BZRQ1712G15DNE	black	●
2700K	154W	LED strip	24V	8863lm	90	DALI	BZRQ1712G15DOR	gold	●
3000K	154W	LED strip	24V	9384lm	90	DALI	BZRQ1712G15WBO	white	○
3000K	154W	LED strip	24V	9384lm	90	DALI	BZRQ1712G15WNE	black	●
3000K	154W	LED strip	24V	9384lm	90	DALI	BZRQ1712G15WOR	gold	●
4000K	154W	LED strip	24V	10427lm	90	DALI	BZRQ1712G15NBO	white	○
4000K	154W	LED strip	24V	10427lm	90	DALI	BZRQ1712G15NNE	black	●
4000K	154W	LED strip	24V	10427lm	90	DALI	BZRQ1712G15NOR	gold	●
note	remote driver   RAL 9005 black   RAL 9016 white   shipped assembled								
included	1 x driver 250W (220/240V)   1 x dimmer DALI   1 x electrical cable 5m   4 x adjustable metal cable length 3m (including ceiling attachment)								
optional accessory	driver box   ceiling plate for remote driver (more specification on p.98-97)								
customizations	find customizable features on p.15								

CE UK CA IP40

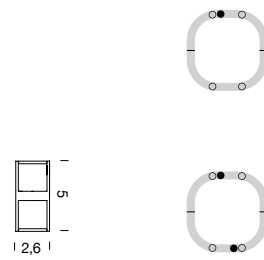
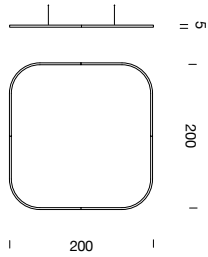

aluminium structure profile

downlight

- power input
- metal cable
- split

up-downlight

- power input
- metal cable
- split

## ZIRKOL SQUARE Q 2 x 2m | DALI

### DOWNLIGHT

CCT	max power	source	voltage	lum. flux	CRI	switching	code	finish
2700K	105W	LED strip	24V	6098lm	90	DALI	BZRQ1608G15DBO	white ○
2700K	105W	LED strip	24V	6098lm	90	DALI	BZRQ1608G15DNE	black ●
2700K	105W	LED strip	24V	6098lm	90	DALI	BZRQ1608G15DOR	gold ●
3000K	105W	LED strip	24V	6456lm	90	DALI	BZRQ1608G15WBO	white ○
3000K	105W	LED strip	24V	6456lm	90	DALI	BZRQ1608G15WNE	black ●
3000K	105W	LED strip	24V	6456lm	90	DALI	BZRQ1608G15WOR	gold ●
4000K	105W	LED strip	24V	7174lm	90	DALI	BZRQ1608G15NBO	white ○
4000K	105W	LED strip	24V	7174lm	90	DALI	BZRQ1608G15NNE	black ●
4000K	105W	LED strip	24V	7174lm	90	DALI	BZRQ1608G15NOR	gold ●

note remote driver | RAL 9005 black | RAL 9016 white | shipped in 2 pieces

included 1 x driver 150W (220/240V) | 1 x dimmer DAL | 1 x electrical cable 5m | 4 x adjustable metal cable length 3m (including ceiling attachment)

optional accessory driver box | ceiling plate for remote driver (more specification on p.98-97)

customizations find customizable features on p.15



### UP-DOWNLIGHT

CCT	max power	source	voltage	lum. flux	CRI	switching	code	finish
2700K	211W	LED strip	24V	12195lm	90	DALI	BZRQ1716G15DBO	white ○
2700K	211W	LED strip	24V	12195lm	90	DALI	BZRQ1716G15DNE	black ●
2700K	211W	LED strip	24V	12195lm	90	DALI	BZRQ1716G15DOR	gold ●
3000K	211W	LED strip	24V	12912lm	90	DALI	BZRQ1716G15WBO	white ○
3000K	211W	LED strip	24V	12912lm	90	DALI	BZRQ1716G15WNE	black ●
3000K	211W	LED strip	24V	12912lm	90	DALI	BZRQ1716G15WOR	gold ●
4000K	211W	LED strip	24V	14347lm	90	DALI	BZRQ1716G15NBO	white ○
4000K	211W	LED strip	24V	14347lm	90	DALI	BZRQ1716G15NNE	black ●
4000K	211W	LED strip	24V	14347lm	90	DALI	BZRQ1716G15NOR	gold ●

note remote driver | RAL 9005 black | RAL 9016 white | shipped in 2 pieces

included 1 x driver 250W (220/240V) | 1 x dimmer DALI | 2 x electrical cable 5m | 4 x adjustable metal cable length 3m (including ceiling attachment)

optional accessory driver box | ceiling plate for remote driver (more specification on p.98-97)

customizations find customizable features on p.15



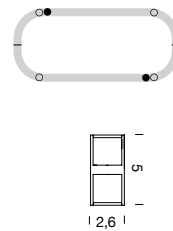
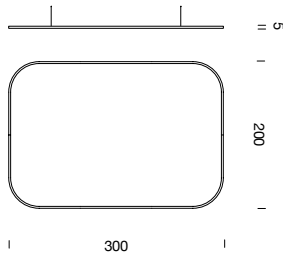

downlight/up-downlight

- power input
- metal cable
- split

aluminium structure profile

## ZIRKOL SQUARE Q 3 x 2m | DALI

### DOWNLIGHT

CCT	max power	source	voltage	lum. flux	CRI	switching	code	finish
2700K	134W	LED strip	24V	7764lm	90	DALI	BZRQ1610G15DBO	white ○
2700K	134W	LED strip	24V	7764lm	90	DALI	BZRQ1610G15DNE	black ●
2700K	134W	LED strip	24V	7764lm	90	DALI	BZRQ1610G15DOR	gold ●
3000K	134W	LED strip	24V	8220lm	90	DALI	BZRQ1610G15WBO	white ○
3000K	134W	LED strip	24V	8220lm	90	DALI	BZRQ1610G15WNE	black ●
3000K	134W	LED strip	24V	8220lm	90	DALI	BZRQ1610G15WOR	gold ●
4000K	134W	LED strip	24V	9134lm	90	DALI	BZRQ1610G15NBO	white ○
4000K	134W	LED strip	24V	9134lm	90	DALI	BZRQ1610G15NNE	black ●
4000K	134W	LED strip	24V	9134lm	90	DALI	BZRQ1610G15NOR	gold ●

note remote driver | RAL 9005 black | RAL 9016 white | shipped in 2 pieces

included 1 x driver 150W (220/240V) | 1 x dimmer DALI | 2 x electrical cable 5m | 4 x adjustable metal cable length 3m (including ceiling attachment)

optional accessory driver box | ceiling plate for remote driver (more specification on p.98-97)

customizations find customizable features on p.15



### UP-DOWNLIGHT

CCT	max power	source	voltage	lum. flux	CRI	switching	code	finish
2700K	268W	LED strip	24V	15527lm	90	DALI	BZRQ1720G15DBO	white ○
2700K	268W	LED strip	24V	15527lm	90	DALI	BZRQ1720G15DNE	black ●
2700K	268W	LED strip	24V	15527lm	90	DALI	BZRQ1720G15DOR	gold ●
3000K	268W	LED strip	24V	16440lm	90	DALI	BZRQ1720G15WBO	white ○
3000K	268W	LED strip	24V	16440lm	90	DALI	BZRQ1720G15WNE	black ●
3000K	268W	LED strip	24V	16440lm	90	DALI	BZRQ1720G15WOR	gold ●
4000K	268W	LED strip	24V	18267lm	90	DALI	BZRQ1720G15NBO	white ○
4000K	268W	LED strip	24V	18267lm	90	DALI	BZRQ1720G15NNE	black ●
4000K	268W	LED strip	24V	18267lm	90	DALI	BZRQ1720G15NOR	gold ●

note remote driver | RAL 9005 black | RAL 9016 white | shipped in 2 pieces

included 2 x drivers 150W (220/240V) | 2 x dimmer DALI | 2 x electrical cable 5m | 4 x adjustable metal cable length 3m (including ceiling attachment)

optional accessory driver box | ceiling plate for remote driver (more specification on p.98-97)

customizations find customizable features on p.15





Zirkol Square-Q, white.  
Private project, Berlin

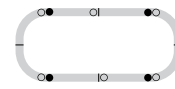
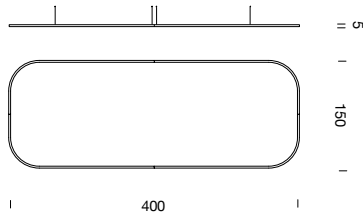

downlight/up-downlight

- power input
- metal cable
- split

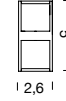
aluminium structure  
profile

## ZIRKOL SQUARE Q 4 x 1,5m | DALI

### DOWNLIGHT

CCT	max power	source	voltage	lum. flux	CRI	switching	code	finish	
2700K	149W	LED strip	24V	8597lm	90	DALI	BZRQ1611G15DBO	white	○
2700K	149W	LED strip	24V	8597lm	90	DALI	BZRQ1611G15DNE	black	●
2700K	149W	LED strip	24V	8597lm	90	DALI	BZRQ1611G15DOR	gold	●
3000K	149W	LED strip	24V	9102lm	90	DALI	BZRQ1611G15WBO	white	○
3000K	149W	LED strip	24V	9102lm	90	DALI	BZRQ1611G15WNE	black	●
3000K	149W	LED strip	24V	9102lm	90	DALI	BZRQ1611G15WOR	gold	●
4000K	149W	LED strip	24V	10114lm	90	DALI	BZRQ1611G15NBO	white	○
4000K	149W	LED strip	24V	10114lm	90	DALI	BZRQ1611G15NNE	black	●
4000K	149W	LED strip	24V	10114lm	90	DALI	BZRQ1611G15NOR	gold	●

note remote driver | RAL 9005 black | RAL 9016 white | shipped in 4 pieces

included 2 x driver 100W (110/240V) | 2 x dimmer DALI | 4 x electrical cable 5m | 6 x adjustable metal cable length 3m (including ceiling attachment)

optional accessory driver box | ceiling plate for remote driver (more specification on p.98-97)

customizations find customizable features on p.15

CE UK CA IP40

### UP-DOWNLIGHT

CCT	max power	source	voltage	lum. flux	CRI	switching	code	finish	
2700K	297W	LED strip	24V	17193lm	90	DALI	BZRQ1722G15DBO	white	○
2700K	297W	LED strip	24V	17193lm	90	DALI	BZRQ1722G15DNE	black	●
2700K	297W	LED strip	24V	17193lm	90	DALI	BZRQ1722G15DOR	gold	●
3000K	297W	LED strip	24V	18204lm	90	DALI	BZRQ1722G15WBO	white	○
3000K	297W	LED strip	24V	18204lm	90	DALI	BZRQ1722G15WNE	black	●
3000K	297W	LED strip	24V	18204lm	90	DALI	BZRQ1722G15WOR	gold	●
4000K	297W	LED strip	24V	20227lm	90	DALI	BZRQ1722G15NBO	white	○
4000K	297W	LED strip	24V	20227lm	90	DALI	BZRQ1722G15NNE	black	●
4000K	297W	LED strip	24V	20227lm	90	DALI	BZRQ1722G15NOR	gold	●

note remote driver | RAL 9005 black | RAL 9016 white | shipped in 4 pieces

included 2 x drivers 150W (220/240V) | 2 x dimmer DALI | 4 x electrical cable 5m | 4 x adjustable metal cable length 3m (including ceiling attachment)

optional accessory driver box | ceiling plate for remote driver (more specification on p.98-97)

customizations find customizable features on p.15

CE UK CA IP40

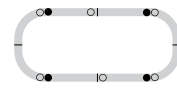
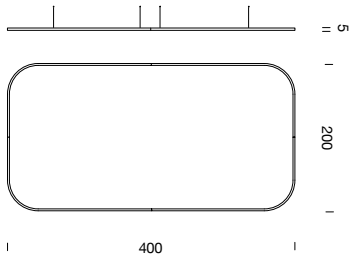

downlight/up-downlight

- power input
- metal cable
- split

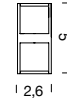

aluminium structure profile

## ZIRKOL SQUARE Q 4 x 2m | DALI

### DOWNLIGHT

CCT	max power	source	voltage	lum. flux	CRI	switching	code	finish	
2700K	163W	LED strip	24V	9430lm	90	DALI	BZRQ1612G15DBO	white	○
2700K	163W	LED strip	24V	9430lm	90	DALI	BZRQ1612G15DNE	black	●
2700K	163W	LED strip	24V	9430lm	90	DALI	BZRQ1612G15DOR	gold	●
3000K	163W	LED strip	24V	9984lm	90	DALI	BZRQ1612G15WBO	white	○
3000K	163W	LED strip	24V	9984lm	90	DALI	BZRQ1612G15WNE	black	●
3000K	163W	LED strip	24V	9984lm	90	DALI	BZRQ1612G15WOR	gold	●
4000K	163W	LED strip	24V	11094lm	90	DALI	BZRQ1612G15NBO	white	○
4000K	163W	LED strip	24V	11094lm	90	DALI	BZRQ1612G15NNE	black	●
4000K	163W	LED strip	24V	11094lm	90	DALI	BZRQ1612G15NOR	gold	●
note	remote driver   RAL 9005 black   RAL 9016 white   shipped in 4 pieces								
included	2 x driver 100W (110/240V)   2 x dimmer DALI   4 x electrical cable 5m   6 x adjustable metal cable length 3m (including ceiling attachment)								
optional accessory	driver box   ceiling plate for remote driver (more specification on p.98-97)								
customizations	find customizable features on p.15								



### UP-DOWNLIGHT

CCT	max power	source	voltage	lum. flux	CRI	switching	code	finish	
2700K	326W	LED strip	24V	18859lm	90	DALI	BZRQ1724G15DBO	white	○
2700K	326W	LED strip	24V	18859lm	90	DALI	BZRQ1724G15DNE	black	●
2700K	326W	LED strip	24V	18859lm	90	DALI	BZRQ1724G15DOR	gold	●
3000K	326W	LED strip	24V	19968lm	90	DALI	BZRQ1724G15WBO	white	○
3000K	326W	LED strip	24V	19968lm	90	DALI	BZRQ1724G15WNE	black	●
3000K	326W	LED strip	24V	19968lm	90	DALI	BZRQ1724G15WOR	gold	●
4000K	326W	LED strip	24V	22187lm	90	DALI	BZRQ1724G15NBO	white	○
4000K	326W	LED strip	24V	22187lm	90	DALI	BZRQ1724G15NNE	black	●
4000K	326W	LED strip	24V	22187lm	90	DALI	BZRQ1724G15NOR	gold	●
note	remote driver   RAL 9005 black   RAL 9016 white   shipped in 4 pieces								
included	2 x driver 250W (220/240V)   2 x dimmer DALI   4 x electrical cable length 5m   6 x adjustable metal cable length 3m (including ceiling attachment)								
optional accessory	driver box   ceiling plate for remote driver (more specification on p.98-97)								
customizations	find customizable features on p.15								





Zirkol Oval, black.  
Private residence, Pinzolo (Trento)



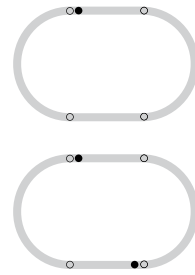
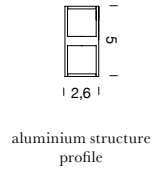
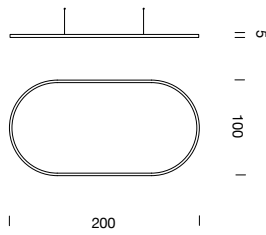

- downlight
- power input
- metal cable
  
- up-downlight
- power input
- metal cable

## ZIRKOL OVAL 2 x 1m | DALI

### DOWNLIGHT

CCT	max power	source	voltage	lum. flux	CRI	switching	code	finish
2700K	74W	LED strip	24V	4282lm	90	DALI	BZRO16A20G15DBO	white ○
2700K	74W	LED strip	24V	4282lm	90	DALI	BZRO16A20G15DNE	black ●
2700K	74W	LED strip	24V	4282lm	90	DALI	BZRO16A20G15DOR	gold ●
3000K	74W	LED strip	24V	4533lm	90	DALI	BZRO16A20G15WBO	white ○
3000K	74W	LED strip	24V	4533lm	90	DALI	BZRO16A20G15WNE	black ●
3000K	74W	LED strip	24V	4533lm	90	DALI	BZRO16A20G15WOR	gold ●
4000K	74W	LED strip	24V	5037lm	90	DALI	BZRO16A20G15NBO	white ○
4000K	74W	LED strip	24V	5037lm	90	DALI	BZRO16A20G15NNE	black ●
4000K	74W	LED strip	24V	5037lm	90	DALI	BZRO16A20G15NOR	gold ●

note remote driver | RAL 9005 black | RAL 9016 white | shipped assembled

included 1 x driver 75W (110/240V) | 1 x dimmer DALI | 1 x electrical cable 5m | 4 x adjustable metal cable length 3m (including ceiling attachment)

optional accessory driver box | ceiling plate for remote driver (more specification on p.98-97)

customizations find customizable features on p.15



### UP-DOWNLIGHT

CCT	max power	source	voltage	lum. flux	CRI	switching	code	finish
2700K	148W	LED strip	24V	8563lm	90	DALI	BZRO17A20G15DBO	white ○
2700K	148W	LED strip	24V	8563lm	90	DALI	BZRO17A20G15DNE	black ●
2700K	148W	LED strip	24V	8563lm	90	DALI	BZRO17A20G15DOR	gold ●
3000K	148W	LED strip	24V	9067lm	90	DALI	BZRO17A20G15WBO	white ○
3000K	148W	LED strip	24V	9067lm	90	DALI	BZRO17A20G15WNE	black ●
3000K	148W	LED strip	24V	9067lm	90	DALI	BZRO17A20G15WOR	gold ●
4000K	148W	LED strip	24V	10074lm	90	DALI	BZRO17A20G15NBO	white ○
4000K	148W	LED strip	24V	10074lm	90	DALI	BZRO17A20G15NNE	black ●
4000K	148W	LED strip	24V	10074lm	90	DALI	BZRO17A20G15NOR	gold ●

note remote driver | RAL 9005 black | RAL 9016 white | shipped assembled

included 1 x driver 150W (220/240V) | 1 x dimmer DALI | 2 x electrical cable 5m | 4 x adjustable metal cable length 3m (including ceiling attachment)

optional accessory driver box | ceiling plate for remote driver (more specification on p.98-97)

customizations find customizable features on p.15







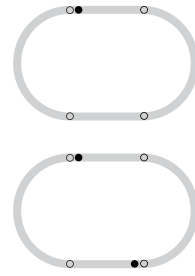
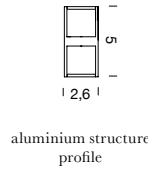
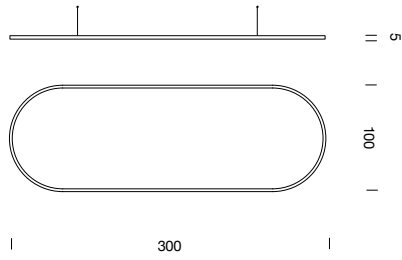

downlight

- power input
- metal cable

up-downlight

- power input
- metal cable

## ZIRKOL OVAL 3 x 1m | DALI

### DOWNLIGHT

CCT	max power	source	voltage	lum. flux	CRI	switching	code	finish	
2700K	103W	LED strip	24V	5948lm	90	DALI	BZRO16A30G15DBO	white	○
2700K	103W	LED strip	24V	5948lm	90	DALI	BZRO16A30G15DNE	black	●
2700K	103W	LED strip	24V	5948lm	90	DALI	BZRO16A30G15DOR	gold	●
3000K	103W	LED strip	24V	6297lm	90	DALI	BZRO16A30G15WBO	white	○
3000K	103W	LED strip	24V	6297lm	90	DALI	BZRO16A30G15WNE	black	●
3000K	103W	LED strip	24V	6297lm	90	DALI	BZRO16A30G15WOR	gold	●
4000K	103W	LED strip	24V	6997lm	90	DALI	BZRO16A30G15NBO	white	○
4000K	103W	LED strip	24V	6997lm	90	DALI	BZRO16A30G15NNE	black	●
4000K	103W	LED strip	24V	6997lm	90	DALI	BZRO16A30G15NOR	gold	●

note remote driver | RAL 9005 black | RAL 9016 white | shipped assembled

included 1 x driver 150W (220/240V) | 1 x dimmer DALI | 1 x electrical cable 5m | 4 x adjustable metal cable length 3m (including ceiling attachment)

optional accessory driver box | ceiling plate for remote driver (more specification on p.98-97)

customizations find customizable features on p.15



### UP-DOWNLIGHT

CCT	max power	source	voltage	lum. flux	CRI	switching	code	finish	
2700K	206W	LED strip	24V	11895lm	90	DALI	BZRO17A30G15DBO	white	○
2700K	206W	LED strip	24V	11895lm	90	DALI	BZRO17A30G15DNE	black	●
2700K	206W	LED strip	24V	11895lm	90	DALI	BZRO17A30G15DOR	gold	●
3000K	206W	LED strip	24V	12595lm	90	DALI	BZRO17A30G15WBO	white	○
3000K	206W	LED strip	24V	12595lm	90	DALI	BZRO17A30G15WNE	black	●
3000K	206W	LED strip	24V	12595lm	90	DALI	BZRO17A30G15WOR	gold	●
4000K	206W	LED strip	24V	13994lm	90	DALI	BZRO17A30G15NBO	white	○
4000K	206W	LED strip	24V	13994lm	90	DALI	BZRO17A30G15NNE	black	●
4000K	206W	LED strip	24V	13994lm	90	DALI	BZRO17A30G15NOR	gold	●

note remote driver | RAL 9005 black | RAL 9016 white | shipped assembled

included 1 x driver 250W (220/240V) | 1 x dimmer DALI | 2 x electrical cable 5m | 4 x adjustable metal cable length 3m (including ceiling attachment)

optional accessory driver box | ceiling plate for remote driver (more specification on p.98-97)

customizations find customizable features on p.15



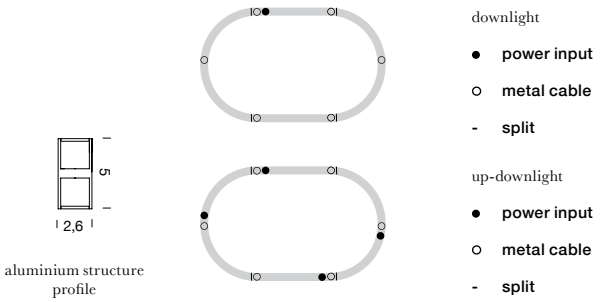
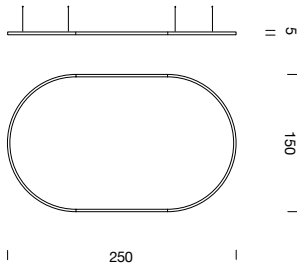

## ZIRKOL OVAL 2,5 x 1,5m | DALI

### DOWNLIGHT

CCT	max power	source	voltage	lum. flux	CRI	switching	code	finish
2700K	97W	LED strip	24V	5589lm	90	DALI	BZRO16B25G15DBO	white ○
2700K	97W	LED strip	24V	5589lm	90	DALI	BZRO16B25G15DNE	black ●
2700K	97W	LED strip	24V	5589lm	90	DALI	BZRO16B25G15DOR	gold ●
3000K	97W	LED strip	24V	5918lm	90	DALI	BZRO16B25G15WBO	white ○
3000K	97W	LED strip	24V	5918lm	90	DALI	BZRO16B25G15WNE	black ●
3000K	97W	LED strip	24V	5918lm	90	DALI	BZRO16B25G15WOR	gold ●
4000K	97W	LED strip	24V	6576lm	90	DALI	BZRO16B25G15NBO	white ○
4000K	97W	LED strip	24V	6576lm	90	DALI	BZRO16B25G15NNE	black ●
4000K	97W	LED strip	24V	6576lm	90	DALI	BZRO16B25G15NOR	gold ●

note remote driver | RAL 9005 black | RAL 9016 white | shipped in 4 pieces

included 1 x driver 100W (110/240V) | 1 x dimmer DALI | 1 x electrical cable 5m | 6 x adjustable metal cable length 3m (including ceiling attachment)

optional accessory driver box | ceiling plate for remote driver (more specification on p.98-97)

customizations find customizable features on p.15



### UP-DOWNLIGHT

CCT	max power	source	voltage	lum. flux	CRI	switching	code	finish
2700K	193W	LED strip	24V	11179lm	90	DALI	BZRO17B25G15DBO	white ○
2700K	193W	LED strip	24V	11179lm	90	DALI	BZRO17B25G15DNE	black ●
2700K	193W	LED strip	24V	11179lm	90	DALI	BZRO17B25G15DOR	gold ●
3000K	193W	LED strip	24V	11836lm	90	DALI	BZRO17B25G15WBO	white ○
3000K	193W	LED strip	24V	11836lm	90	DALI	BZRO17B25G15WNE	black ●
3000K	193W	LED strip	24V	11836lm	90	DALI	BZRO17B25G15WOR	gold ●
4000K	193W	LED strip	24V	13152lm	90	DALI	BZRO17B25G15NBO	white ○
4000K	193W	LED strip	24V	13152lm	90	DALI	BZRO17B25G15NNE	black ●
4000K	193W	LED strip	24V	13152lm	90	DALI	BZRO17B25G15NOR	gold ●

note remote driver | RAL 9005 black | RAL 9016 white | shipped in 4 pieces

included 2 x driver 100W (110/240V) | 2 x dimmer DALI | 4 x electrical cable 5m | 6 x adjustable metal cable length 3m (including ceiling attachment)

optional accessory driver box | ceiling plate for remote driver (more specification on p.98-97)

customizations find customizable features on p.15



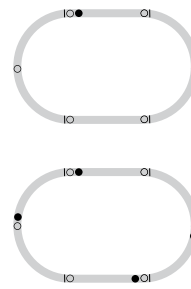
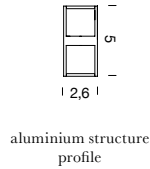
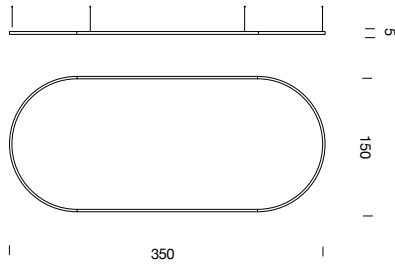

- downlight
- power input
  - metal cable
  - split
- up-downlight
- power input
  - metal cable
  - split

## ZIRKOL OVAL 3,5 x 1,5m | DALI

### DOWNLIGHT

CCT	max power	source	voltage	lum. flux	CRI	switching	code	finish	
2700K	125W	LED strip	24V	7255lm	90	DALI	BZRO16B35G15DBO	white	○
2700K	125W	LED strip	24V	7255lm	90	DALI	BZRO16B35G15DNE	black	●
2700K	125W	LED strip	24V	7255lm	90	DALI	BZRO16B35G15DOR	gold	●
3000K	125W	LED strip	24V	7682lm	90	DALI	BZRO16B35G15WBO	white	○
3000K	125W	LED strip	24V	7682lm	90	DALI	BZRO16B35G15WNE	black	●
3000K	125W	LED strip	24V	7682lm	90	DALI	BZRO16B35G15WOR	gold	●
4000K	125W	LED strip	24V	8536lm	90	DALI	BZRO16B35G15NBO	white	○
4000K	125W	LED strip	24V	8536lm	90	DALI	BZRO16B35G15NNE	black	●
4000K	125W	LED strip	24V	8536lm	90	DALI	BZRO16B35G15NOR	gold	●
note	remote driver   RAL 9005 black   RAL 9016 white   shipped in 4 pieces								
included	1 x driver 150W (220/240V)   1 x dimmer DALI   1 x electrical cable 5m   6 x adjustable metal cable length 3m (including ceiling attachment)								
optional accessory	driver box   ceiling plate for remote driver (more specification on p.98-97)								
customizations	find customizable features on p.15								

CE UK CA IP40

### UP-DOWNLIGHT

CCT	max power	source	voltage	lum. flux	CRI	switching	code	finish	
2700K	251W	LED strip	24V	14511lm	90	DALI	BZRO17B35G15DBO	white	○
2700K	251W	LED strip	24V	14511lm	90	DALI	BZRO17B35G15DNE	black	●
2700K	251W	LED strip	24V	14511lm	90	DALI	BZRO17B35G15DOR	gold	●
3000K	251W	LED strip	24V	15364lm	90	DALI	BZRO17B35G15WBO	white	○
3000K	251W	LED strip	24V	15364lm	90	DALI	BZRO17B35G15WNE	black	●
3000K	251W	LED strip	24V	15364lm	90	DALI	BZRO17B35G15WOR	gold	●
4000K	251W	LED strip	24V	17072lm	90	DALI	BZRO17B35G15NBO	white	○
4000K	251W	LED strip	24V	17072lm	90	DALI	BZRO17B35G15NNE	black	●
4000K	251W	LED strip	24V	17072lm	90	DALI	BZRO17B35G15NOR	gold	●
note	remote driver   RAL 9005 black   RAL 9016 white   shipped in 4 pieces								
included	2 x drivers 150W (220/240V)   2 x dimmer DALI   4 x electrical cable 5m   6 x adjustable metal cable length 3m (including ceiling attachment)								
optional accessory	driver box   ceiling plate for remote driver (more specification on p.98-97)								
customizations	find customizable features on p.15								

CE UK CA IP40

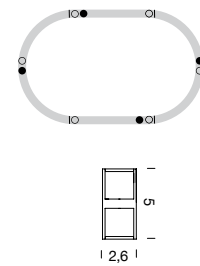
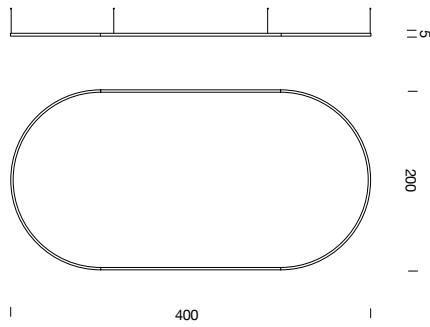

downlight/up-downlight

- power input
- metal cable
- split

aluminium structure profile

## ZIRKOL OVAL 4 x 2m | DALI

### DOWNLIGHT

CCT	max power	source	voltage	lum. flux	CRI	switching	code	finish
2700K	148W	LED strip	24V	8536lm	90	DALI	BZRO16C40G15DBO	white ○
2700K	148W	LED strip	24V	8536lm	90	DALI	BZRO16C40G15DNE	black ●
2700K	148W	LED strip	24V	8536lm	90	DALI	BZRO16C40G15DOR	gold ●
3000K	148W	LED strip	24V	9067lm	90	DALI	BZRO16C40G15WBO	white ○
3000K	148W	LED strip	24V	9067lm	90	DALI	BZRO16C40G15WNE	black ●
3000K	148W	LED strip	24V	9067lm	90	DALI	BZRO16C40G15WOR	gold ●
4000K	148W	LED strip	24V	10074lm	90	DALI	BZRO16C40G15NBO	white ○
4000K	148W	LED strip	24V	10074lm	90	DALI	BZRO16C40G15NNE	black ●
4000K	148W	LED strip	24V	10074lm	90	DALI	BZRO16C40G15NOR	gold ●

note remote driver | RAL 9005 black | RAL 9016 white | shipped in 4 pieces

included 2 x driver 100W (110/240V) | 2 x dimmer DALI | 4 x electrical cable 5m | 6 x adjustable metal cable length 3m (including ceiling attachment)

optional accessory driver box | ceiling plate for remote driver (more specification on p.98-97)

customizations find customizable features on p.15



### UP-DOWNLIGHT

CCT	max power	source	voltage	lum. flux	CRI	switching	code	finish
2700K	296W	LED strip	24V	17126lm	90	DALI	BZRO17C40G15DBO	white ○
2700K	296W	LED strip	24V	17126lm	90	DALI	BZRO17C40G15DNE	black ●
2700K	296W	LED strip	24V	17126lm	90	DALI	BZRO17C40G15DOR	gold ●
3000K	296W	LED strip	24V	18134lm	90	DALI	BZRO17C40G15WBO	white ○
3000K	296W	LED strip	24V	18134lm	90	DALI	BZRO17C40G15WNE	black ●
3000K	296W	LED strip	24V	18134lm	90	DALI	BZRO17C40G15WOR	gold ●
4000K	296W	LED strip	24V	20149lm	90	DALI	BZRO17C40G15NBO	white ○
4000K	296W	LED strip	24V	20149lm	90	DALI	BZRO17C40G15NNE	black ●
4000K	296W	LED strip	24V	20149lm	90	DALI	BZRO17C40G15NOR	gold ●

note remote driver | RAL 9005 black | RAL 9016 white | shipped in 4 pieces

included 2 x drivers 150W (220/240V) | 2 x dimmer DALI | 4 x electrical cable 5m | 6 x adjustable metal cable length 3m (including ceiling attachment)

optional accessory driver box | ceiling plate for remote driver (more specification on p.98-97)

customizations find customizable features on p.15









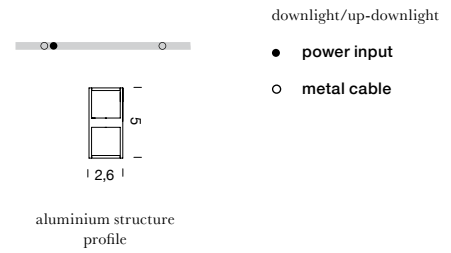
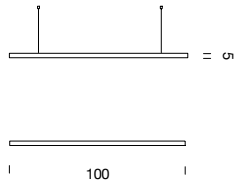

## ZIRKOL LINEAR 1m | DALI

### DOWNLIGHT

CCT	max power	source	voltage	lum. flux	CRI	switching	code	finish	
2700K	14,5W	LED strip	24V	833lm	90	DALI	BZRL1610G15DBO	white	○
2700K	14,5W	LED strip	24V	833lm	90	DALI	BZRL1610G15DNE	black	●
2700K	14,5W	LED strip	24V	833lm	90	DALI	BZRL1610G15DOR	gold	●
3000K	14,5W	LED strip	24V	882lm	90	DALI	BZRL1610G15WBO	white	○
3000K	14,5W	LED strip	24V	882lm	90	DALI	BZRL1610G15WNE	black	●
3000K	14,5W	LED strip	24V	882lm	90	DALI	BZRL1610G15WOR	gold	●
4000K	14,5W	LED strip	24V	980lm	90	DALI	BZRL1610G15NBO	white	○
4000K	14,5W	LED strip	24V	980lm	90	DALI	BZRL1610G15NNE	black	●
4000K	14,5W	LED strip	24V	980lm	90	DALI	BZRL1610G15NOR	gold	●

note remote driver | RAL 9005 black | RAL 9016 white | shipped assembled

included 1 x driver 20W (220/240V) | 1 x dimmer DALI | 1 electrical cable length 5m | 2 x adjustable metal cable length 3m (including ceiling attachment)

optional accessory driver box | ceiling plate for remote driver (more specification on p.98-97)

customizations find customizable features on p.15

CE UK CA IP40

### UP-DOWNLIGHT

CCT	max power	source	voltage	lum. flux	CRI	switching	code	finish	
2700K	29W	LED strip	24V	1666lm	90	DALI	BZRL1710G15DBO	white	○
2700K	29W	LED strip	24V	1666lm	90	DALI	BZRL1710G15DNE	black	●
2700K	29W	LED strip	24V	1666lm	90	DALI	BZRL1710G15DOR	gold	●
3000K	29W	LED strip	24V	1764lm	90	DALI	BZRL1710G15WBO	white	○
3000K	29W	LED strip	24V	1764lm	90	DALI	BZRL1710G15WNE	black	●
3000K	29W	LED strip	24V	1764lm	90	DALI	BZRL1710G15WOR	gold	●
4000K	29W	LED strip	24V	1960lm	90	DALI	BZRL1710G15NBO	white	○
4000K	29W	LED strip	24V	1960lm	90	DALI	BZRL1710G15NNE	black	●
4000K	29W	LED strip	24V	1960lm	90	DALI	BZRL1710G15NOR	gold	●

note remote driver | RAL 9005 black | RAL 9016 white | shipped assembled

included 1 x driver 60W (220/240V) | 1 x dimmer DALI | 1 electrical cable length 5m | 2 adjustable metal cable length 3m (including ceiling attachment)

optional accessory driver box | ceiling plate for remote driver (more specification on p.98-97)

customizations find customizable features on p.15

CE UK CA IP40

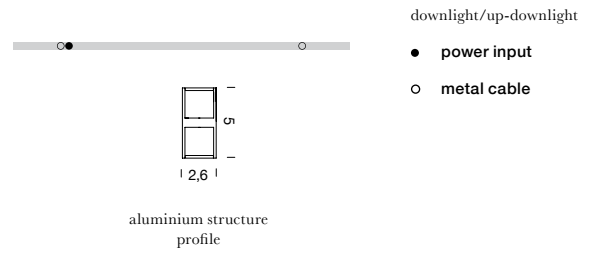
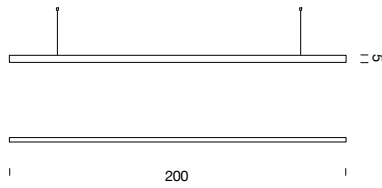

## ZIRKOL LINEAR 2m | DALI

### DOWNLIGHT

CCT	max power	source	voltage	lum. flux	CRI	switching	code	finish	
2700K	29W	LED strip	24V	1666lm	90	DALI	BZRL1620G15DBO	white ○	
2700K	29W	LED strip	24V	1666lm	90	DALI	BZRL1620G15DNE	black ●	
2700K	29W	LED strip	24V	1666lm	90	DALI	BZRL1620G15DOR	gold ●	
3000K	29W	LED strip	24V	1764lm	90	DALI	BZRL1620G15WBO	white ○	
3000K	29W	LED strip	24V	1764lm	90	DALI	BZRL1620G15WNE	black ●	
3000K	29W	LED strip	24V	1764lm	90	DALI	BZRL1620G15WOR	gold ●	
4000K	29W	LED strip	24V	1960lm	90	DALI	BZRL1620G15NBO	white ○	
4000K	29W	LED strip	24V	1960lm	90	DALI	BZRL1620G15NNE	black ●	
4000K	29W	LED strip	24V	1960lm	90	DALI	BZRL1620G15NOR	gold ●	
note	remote driver   RAL 9005 black   RAL 9016 white   shipped assembled								
included	1 x driver 60W (220/240V)   1 x dimmer DALI   1 electrical cable length 5m   2 adjustable metal cable length 3m (including ceiling attachment)								
optional accessory	driver box   ceiling plate for remote driver (more specification on p.98-97)								
customizations	find customizable features on p.15								



### UP-DOWNLIGHT

CCT	max power	source	voltage	lum. flux	CRI	switching	code	finish	
2700K	58W	LED strip	24V	3332lm	90	DALI	BZRL1720G15DBO	white ○	
2700K	58W	LED strip	24V	3332lm	90	DALI	BZRL1720G15DNE	black ●	
2700K	58W	LED strip	24V	3332lm	90	DALI	BZRL1720G15DOR	gold ●	
3000K	58W	LED strip	24V	3528lm	90	DALI	BZRL1720G15WBO	white ○	
3000K	58W	LED strip	24V	3528lm	90	DALI	BZRL1720G15WNE	black ●	
3000K	58W	LED strip	24V	3528lm	90	DALI	BZRL1720G15WOR	gold ●	
4000K	58W	LED strip	24V	3920lm	90	DALI	BZRL1720G15NBO	white ○	
4000K	58W	LED strip	24V	3920lm	90	DALI	BZRL1720G15NNE	black ●	
4000K	58W	LED strip	24V	3920lm	90	DALI	BZRL1720G15NOR	gold ●	
note	remote driver   RAL 9005 black   RAL 9016 white   shipped assembled								
included	1 x driver 60W (220/240V)   1 x dimmer DALI   1 electrical cable length 5m   2 adjustable metal cable length 3m (including ceiling attachment)								
optional accessory	driver box   ceiling plate for remote driver (more specification on p.98-97)								
customizations	find customizable features on p.15								



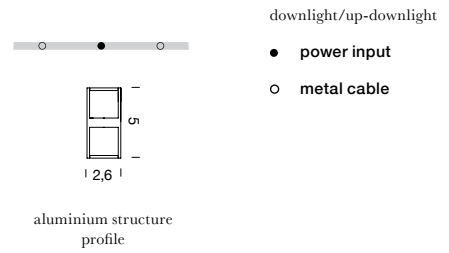
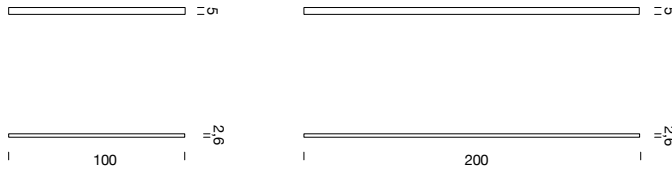

## ZIRKOL LINEAR CEILING 1m | ON/OFF

### DOWNLIGHT

CCT	max power	source	voltage	lum. flux	CRI	switching	code	finish
2700K	28W	LED strip	220/240V	1900lm	90	ON/OFF	BZRLU410G15DBO	white ○
2700K	28W	LED strip	220/240V	1900lm	90	ON/OFF	BZRLU410G15DNE	black ●
2700K	28W	LED strip	220/240V	1900lm	90	ON/OFF	BZRLU410G15DOR	gold ●
3000K	28W	LED strip	220/240V	2000lm	90	ON/OFF	BZRLU410G15WBO	white ○
3000K	28W	LED strip	220/240V	2000lm	90	ON/OFF	BZRLU410G15WNE	black ●
3000K	28W	LED strip	220/240V	2000lm	90	ON/OFF	BZRLU410G15WOR	gold ●
4000K	28W	LED strip	220/240V	2100lm	90	ON/OFF	BZRLU410G15NBO	white ○
4000K	28W	LED strip	220/240V	2100lm	90	ON/OFF	BZRLU410G15NNE	black ●
4000K	28W	LED strip	220/240V	2100lm	90	ON/OFF	BZRLU410G15NOR	gold ●
note	integrated driver   RAL 9005 black   RAL 9016 white							
included	1 x driver Ultraslim 60W (220/240V)							
customizations	length							



## ZIRKOL LINEAR CEILING 2m | ON/OFF

### DOWNLIGHT

CCT	max power	source	voltage	lum. flux	CRI	switching	code	finish
2700K	56W	LED strip	220/240V	3800lm	90	ON/OFF	BZRLU420G15DBO	white ○
2700K	56W	LED strip	220/240V	3800lm	90	ON/OFF	BZRLU420G15DNE	black ●
2700K	56W	LED strip	220/240V	3800lm	90	ON/OFF	BZRLU420G15DOR	gold ●
3000K	56W	LED strip	220/240V	4000lm	90	ON/OFF	BZRLU420G15WBO	white ○
3000K	56W	LED strip	220/240V	4000lm	90	ON/OFF	BZRLU420G15WNE	black ●
3000K	56W	LED strip	220/240V	4000lm	90	ON/OFF	BZRLU420G15WOR	gold ●
4000K	56W	LED strip	220/240V	4200lm	90	ON/OFF	BZRLU420G15NBO	white ○
4000K	56W	LED strip	220/240V	4200lm	90	ON/OFF	BZRLU420G15NNE	black ●
4000K	56W	LED strip	220/240V	4200lm	90	ON/OFF	BZRLU420G15NOR	gold ●
note	integrated driver   RAL 9005 black   RAL 9016 white							
included	1 x driver Ultraslim 60W (220/240V)							
customizations	length							



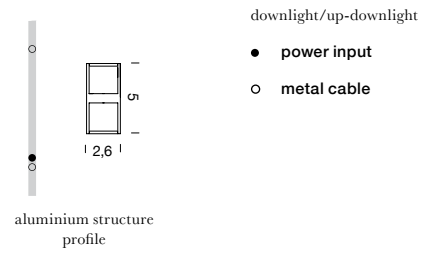
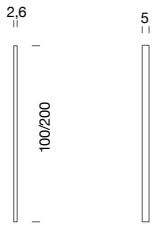

## ZIRKOL LINEAR WALL 1m | ON/OFF

### DIRECT

CCT	max power	source	voltage	lum. flux	CRI	switching	code	finish	
2700K	14,5W	LED strip	220/240V	833lm	90	ON/OFF	BZRL4010G15DBO	white	○
2700K	14,5W	LED strip	220/240V	833lm	90	ON/OFF	BZRL4010G15DNE	black	●
2700K	14,5W	LED strip	220/240V	833lm	90	ON/OFF	BZRL4010G15DOR	gold	●
3000K	14,5W	LED strip	220/240V	882lm	90	ON/OFF	BZRL4010G15WBO	white	○
3000K	14,5W	LED strip	220/240V	882lm	90	ON/OFF	BZRL4010G15WNE	black	●
3000K	14,5W	LED strip	220/240V	882lm	90	ON/OFF	BZRL4010G15WOR	gold	●
4000K	14,5W	LED strip	220/240V	980lm	90	ON/OFF	BZRL4010G15NBO	white	○
4000K	14,5W	LED strip	220/240V	980lm	90	ON/OFF	BZRL4010G15NNE	black	●
4000K	14,5W	LED strip	220/240V	980lm	90	ON/OFF	BZRL4010G15NOR	gold	●
note	integrated driver   RAL 9005 black   RAL 9016 white								
included	1 x driver Ultraslim 60W (220/240V)								
customizations	length   lumen output								

CE UK CA IP40

## ZIRKOL LINEAR WALL 2m | ON/OFF

### DIRECT

CCT	max power	source	voltage	lum. flux	CRI	switching	code	finish	
2700K	29W	LED strip	220/240V	1666lm	90	ON/OFF	BZRL4020G15DBO	white	○
2700K	29W	LED strip	220/240V	1666lm	90	ON/OFF	BZRL4020G15DNE	black	●
2700K	29W	LED strip	220/240V	1666lm	90	ON/OFF	BZRL4020G15DOR	gold	●
3000K	29W	LED strip	220/240V	1764lm	90	ON/OFF	BZRL4020G15WBO	white	○
3000K	29W	LED strip	220/240V	1764lm	90	ON/OFF	BZRL4020G15WNE	black	●
3000K	29W	LED strip	220/240V	1764lm	90	ON/OFF	BZRL4020G15WOR	gold	●
4000K	29W	LED strip	220/240V	1960lm	90	ON/OFF	BZRL4020G15NBO	white	○
4000K	29W	LED strip	220/240V	1960lm	90	ON/OFF	BZRL4020G15NNE	black	●
4000K	29W	LED strip	220/240V	1960lm	90	ON/OFF	BZRL4020G15NOR	gold	●
note	integrated driver   RAL 9005 black   RAL 9016 white								
included	1 x driver Ultraslim 60W (220/240V)								
customizations	length   lumen output								

CE UK CA IP40

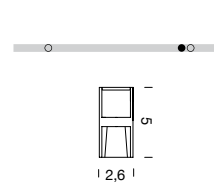
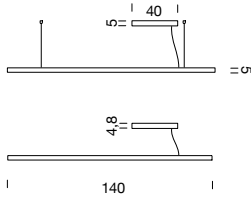

aluminium structure profile

downlight

- power input
- metal cable

## ZIRKOL LINEAR UGR 1,40m | DALI

### DOWNLIGHT

CCT	max power	source	voltage	lum. flux	CRI	switching	code	finish
3000K	45W	LED strip	24V	3600lm	90	DALI/PUSH	BZRL1614I42WBO	white ○
3000K	45W	LED strip	24V	3600lm	90	DALI/PUSH	BZRL1614I42WNE	black ●
4000K	45W	LED strip	24V	3700lm	90	DALI/PUSH	BZRL1614I42NBO	white ○
4000K	45W	LED strip	24V	3700lm	90	DALI/PUSH	BZRL1614I42NNE	black ●

note remote driver | RAL 9005 black | RAL 9016 white

included 1 x driver 60W DALI2 (220/240V) | 1 driver box (40x5x4,5) | 1 electrical cable length 3m | 2 x adjustable metal cable length 3m (including ceiling attachments)

customizations length | white reflectors

CE UK CA IP40 UGR<19

### UP-DOWNLIGHT

CCT	max power	source	voltage	lum. flux	CRI	switching	code	finish
3000K	60W	LED strip	24V	3600+1100lm	90	DALI/PUSH	BZRL1714I49WBO	white ○
3000K	60W	LED strip	24V	3600+1100lm	90	DALI/PUSH	BZRL1714I49WNE	black ●
4000K	60W	LED strip	24V	3700+1200lm	90	DALI/PUSH	BZRL1714I49NBO	white ○
4000K	60W	LED strip	24V	3700+1200lm	90	DALI/PUSH	BZRL1714I49NNE	black ●

note remote driver | RAL 9005 black | RAL 9016 white

included 1 x driver 60W DALI2 (220/240V) | 1 driver box (40x5x4,5) | 1 electrical cable length 3m | 2 x adjustable metal cable length 3m (including ceiling attachments)

customizations length | white reflectors

CE UK CA IP40 UGR<19



white



black

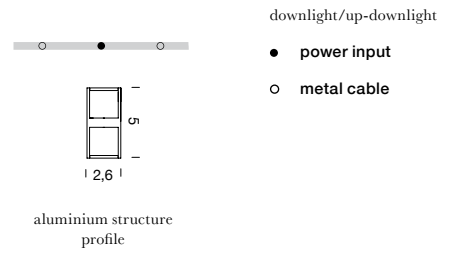
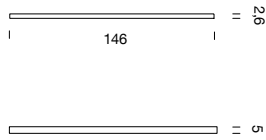

## ZIRKOL LINEAR CEILING UGR 1,46m | ON/OFF

CCT	max power	source	voltage	lum. flux	CRI	switching	code	finish	
3000K	40W	LED strip	220/240V	3600lm	90	ON/OFF	BZRLU414I42WBO	white	○
3000K	40W	LED strip	220/240V	3600lm	90	ON/OFF	BZRLU414I42WNE	black	●
4000K	40W	LED strip	220/240V	3700lm	90	ON/OFF	BZRLU414I42NBO	white	○
4000K	40W	LED strip	220/240V	3700lm	90	ON/OFF	BZRLU414I42NNE	black	●
note	integrated driver   RAL 9005 black   RAL 9016 white								
included	1 x driver Ultraslim 60W (220/240V)								
customizations	length   white reflectors								

CE UK CA IP40 UGR<19

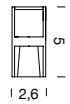
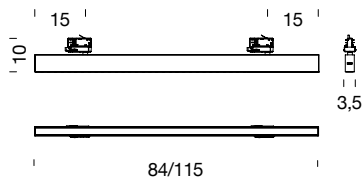
aluminium  
structure profile

## ZIRKOL TRACK UGR 0,84m | ON/OFF

### DOWNLIGHT

CCT	max power	source	voltage	lum. flux	CRI	switching	code	finish	
3000K	26W	LED strip	220/240V	2160lm	90	ON/OFF	BZRL54084I42WBO	white ○	
3000K	26W	LED strip	220/240V	2160lm	90	ON/OFF	BZRL54084I42WNE	black ●	
4000K	26W	LED strip	220/240V	2220lm	90	ON/OFF	BZRL54084I42NBO	white ○	
4000K	26W	LED strip	220/240V	2220lm	90	ON/OFF	BZRL54084I42NNE	black ●	
note	integrated driver   RAL 9005 black   RAL 9016 white   compatible with TRACK 3C/0-10V" p.98								
included	1 x driver Ultraslim 60W (220/240V)								
customizations	length   white reflectors								

CE UK CA IP40 UGR<19

## ZIRKOL TRACK UGR 1,15m | ON/OFF

### DOWNLIGHT

CCT	max power	source	voltage	lum. flux	CRI	switching	code	finish	
3000K	35W	LED strip	220/240V	2957lm	90	ON/OFF	BZRL54115I42WBO	white ○	
3000K	35W	LED strip	220/240V	2957lm	90	ON/OFF	BZRL54115I42WNE	black ●	
4000K	35W	LED strip	220/240V	3039lm	90	ON/OFF	BZRL54115I42NBO	white ○	
4000K	35W	LED strip	220/240V	3039lm	90	ON/OFF	BZRL54115I42NNE	black ●	
note	integrated driver   RAL 9005 black   RAL 9016 white   compatible with TRACK 3C/0-10V" p.98								
included	1 x driver Ultraslim 60W (220/240V)								
customizations	length   white reflectors								

CE UK CA IP40 UGR<19



Zirkol Track UGR



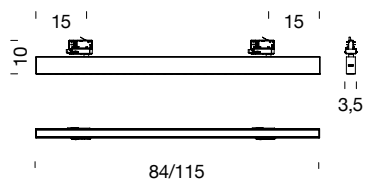

aluminium structure profile

## ZIRKOL TRACK OPAL 0,84m | ON/OFF

### DOWNLIGHT

CCT	max power	source	voltage	lum. flux	CRI	switching	code	finish
3000K	26W	LED strip	220/240V	1680lm	90	ON/OFF	BZRL54084G15WBO	white ○
3000K	26W	LED strip	220/240V	1680lm	90	ON/OFF	BZRL54084G15WNE	black ●
4000K	26W	LED strip	220/240V	1764lm	90	ON/OFF	BZRL54084G15NBO	white ○
4000K	26W	LED strip	220/240V	1764lm	90	ON/OFF	BZRL54084G15NNE	black ●
note	integrated driver   RAL 9005 black   RAL 9016 white   compatible with TRACK 3C/0-10V" p.98							
included	1 x driver Ultralim 60W (220/240V)							
customizations	length							

CE UK CA IP40

## ZIRKOL TRACK OPAL 1,15m | ON/OFF

### DOWNLIGHT

CCT	max power	source	voltage	lum. flux	CRI	switching	code	finish
3000K	35W	LED strip	220/240V	2300lm	90	ON/OFF	BZRL54115G15WBO	white ○
3000K	35W	LED strip	220/240V	2300lm	90	ON/OFF	BZRL54115G15NBO	black ●
4000K	35W	LED strip	220/240V	2415lm	90	ON/OFF	BZRL54115G15WNE	white ○
4000K	35W	LED strip	220/240V	2415lm	90	ON/OFF	BZRL54115G15NNE	black ●
note	integrated driver   RAL 9005 black   RAL 9016 white   compatible with TRACK 3C/0-10V" p.98							
included	1 x driver Ultralim 60W (220/240V)							
customizations	length							

CE UK CA IP40



Zirkol Track Opal

# ZIRKOL CUSTOM

## IT

La gamma Zirkol si declina in un'ampia possibilità di personalizzazione. Per soddisfare qualsiasi esigenza di progetto, possono essere realizzate su richiesta differenti soluzioni. Profili lineari e curvi possono essere combinati e uniti per creare una lampada dal design unico. È possibile selezionare il tipo di emissione della luce (downlight e uplight), la temperatura colore (2700K-3000K-4000K, tunable white, RGB o RGBW), la dimmerazione (DALI, 0-10V, 1-10V o Push) e il controllo della luce (Casambi, DMX, etc.). Ad integrazione delle differenti possibilità di composizione, si inserisce ora anche la versione che include spot orientabili all'interno del profilo. La volontà di soddisfare ogni esigenza progettuale è propria del dinamismo di ILTI LUCE che si impegna ad offrire inoltre un servizio di supporto tecnico, fornendo soluzioni ad hoc per ottenere la luce perfetta.

## EN

Zirkol collection extends to a wide range of customisation possibilities. Unlimited ZIRKOL shapes are available on request to meet any project requirement. Linear and curved profiles can be combined and joined for a unique design lamp. Different types of light emission can be selected (downlight and uplight), color temperature (2700K-3000K-4000K, tunable white, RGB or RGBW), dimming (DALI, 0-10V, 1-10V or Push) and light control (Casambi, DMX, etc.). In addition to the different composition possibilities, a version that includes adjustable spots inside the profile is now available. The desire to satisfy every design requirement is inherent in the dynamism of ILTI LUCE, which is also committed to offering technical support service and providing tailor-made solutions to achieve the perfect light.

## DE

Die unendliche Formenvielfalt von ZIRKOL kann kundenspezifisch angepasst werden, um jede Designanforderung zu erfüllen. Lineare und gebogene Profile können kombiniert und verbunden werden, um eine einzigartig gestaltete Leuchte zu schaffen. Sie können die Art der Lichtverteilung (Downlight und Uplight), die Farbtemperatur (2700K-3000K-4000K, abstimmbares Weiß, RGB oder RGBW), die Dimmung (DALI, 0-10V, 1-10V oder Push) und die Lichtsteuerung (Casambi, DMX, etc.) wählen. Um die verschiedenen Gestaltungsmöglichkeiten zu ergänzen, gibt es jetzt auch eine Version mit einstellbaren Spots innerhalb des Profils. Das Bemühen, allen Anforderungen an die Gestaltung gerecht zu werden, ist Teil der Flexibilität von ILTI LUCE, das sich auch dem technischen Service verschrieben hat und individuelle Lösungen anbietet, um das perfekte Licht zu finden.

## FR

L'infinie variété des formes de ZIRKOL peut être personnalisée sur demande pour satisfaire toute exigence de projet. Les profils linéaires et courbes peuvent être combinés et assemblés pour créer une lampe au design unique. Il est possible de sélectionner le type d'émission lumineuse (downlight et uplight), la température de couleur (2700K-3000K-4000K, blanc réglable, RGB ou RGBW), la gradation (DALI, 0-10V, 1-10V ou Push) et le contrôle de la lumière (Casambi, DMX, etc.). Pour intégrer les différentes possibilités de composition, la version qui comprend des spots orientables dans le profil est désormais également proposée. Le désir de satisfaire chaque exigence de conception est typique du dynamisme de ILTI LUCE qui s'engage également à offrir un service d'assistance technique, en apportant des solutions ad hoc pour obtenir la lumière parfaite.



Zirkol Custom, black.  
Private project, Turin

# SHAPE YOUR ZIRKOL CUSTOM

---

## ZIRKOL **LINEAR**



L1



L2

---

## ZIRKOL **ROUND**



D1



D1,5



D2

---

## ZIRKOL **ANGLE**

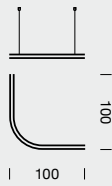

R0,4

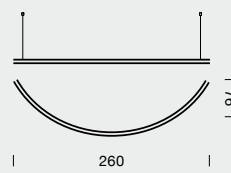

R1,5

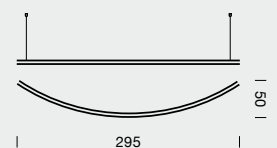

R2,5



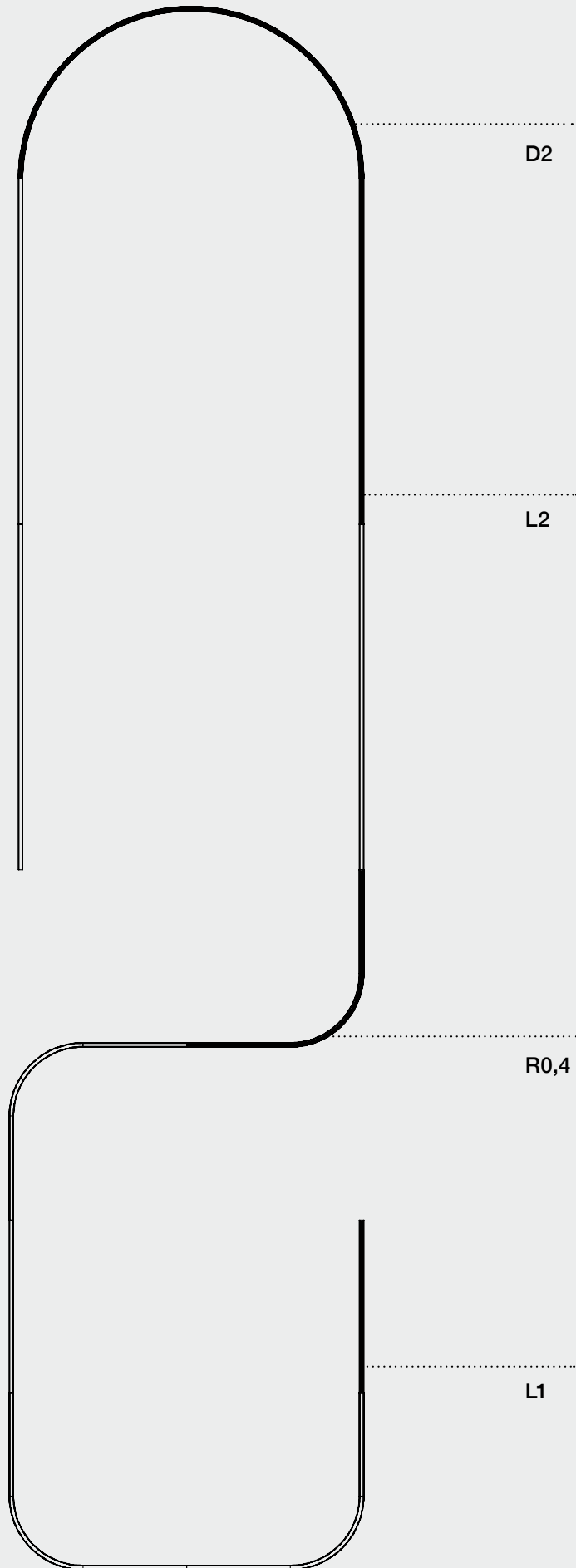

EXAMPLE OF A FEASIBLE CUSTOM ZIRKOL SHAPE

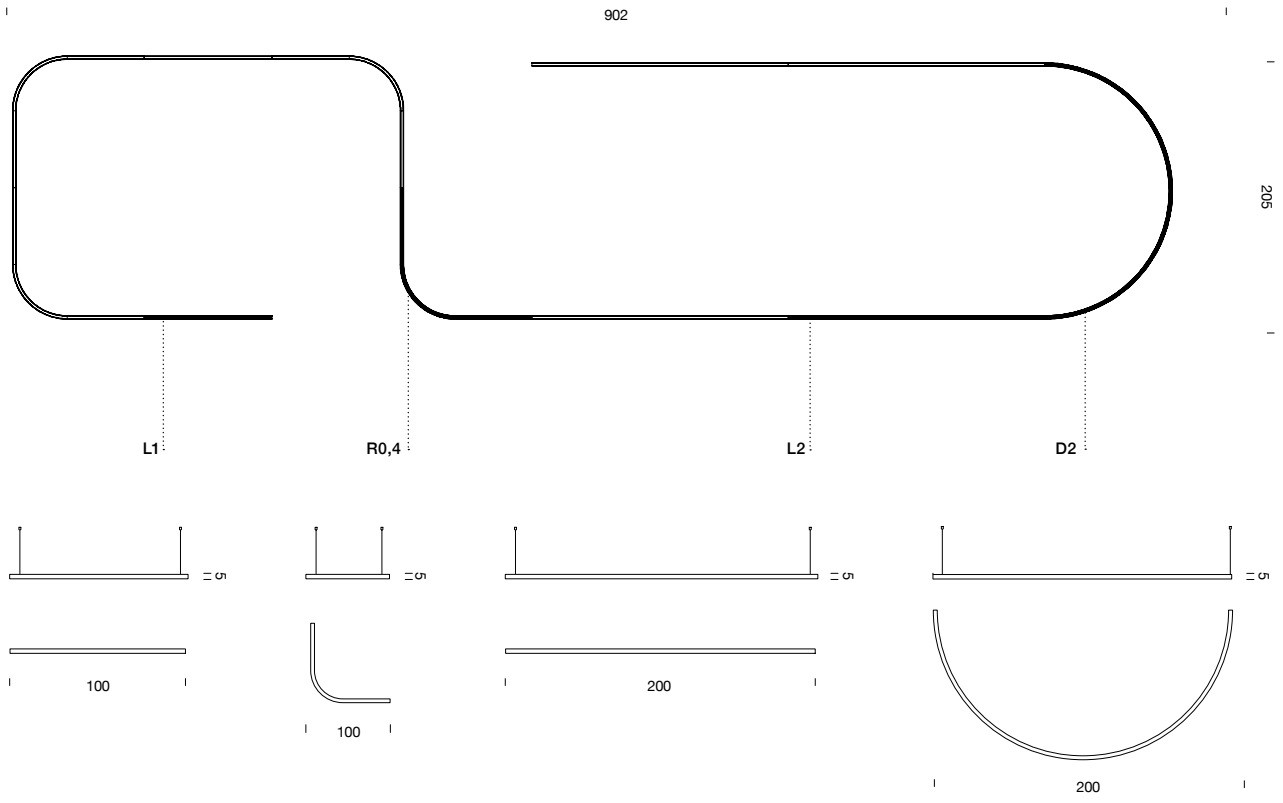



**2xL1+4xL2+4xR0,4+D2 | DOWNLIGHT**

CCT 4000K | 303W | 20904lm

● structure black

Linear LED | diffused | typ cri 90 | DALI 1-100%

canopy 1 driver - electrical cable length 5m | adjustable metal cable length 3m |  
dimmer interface | ceiling attachments

customizations: optional accessories on p.98-97 and custom features on p.15





Zirkol Custom Linear Angle 90°, white.  
Private project, Lyon



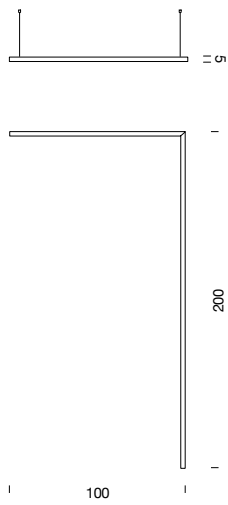

downlight

- power input
- metal cable

**LINEAR ANGLE 90° | DOWNLIGHT**

CCT 4000K | 45W | 2700lm

● structure black

Linear LED | diffused | typ cri 90 | DALI 1-100%

1 x ceiling plate for remote driver - 1 x electrical cable length 5m | 4 x adjustable metal cable length 3m | 1 x driver (remote) | dimmer interface | 4 x ceiling attachment

Shipped assembled

customizations: optional accessories on p.98-97 and custom features on p.15

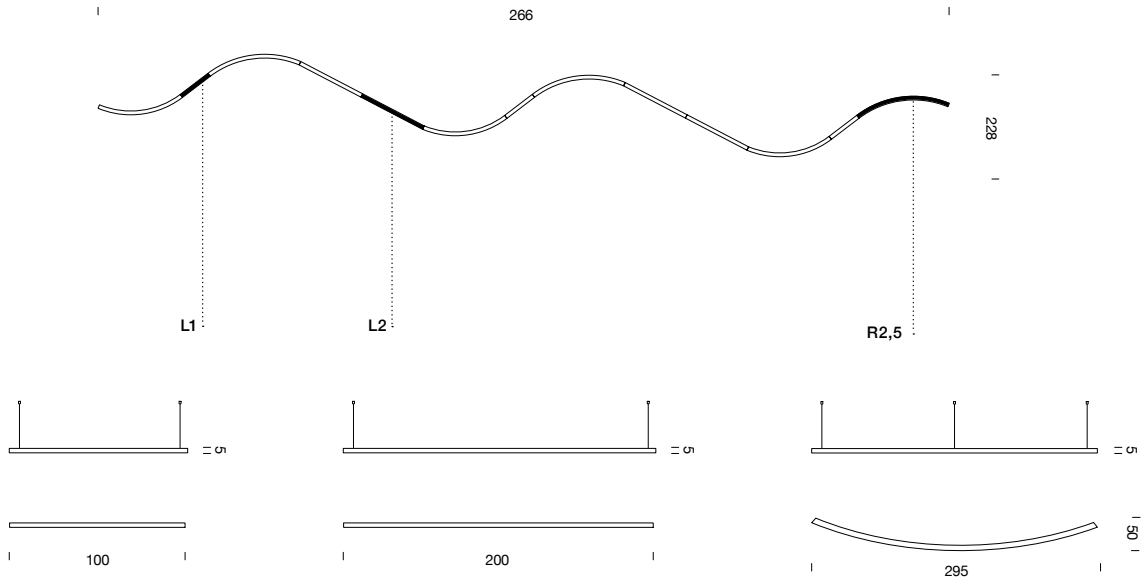

Zirkol Custom , white.  
Domal Showroom, Milan





- downlight
- power input
  - metal cable
  - split

**3xL1+4xL2+6xR2,5 | DOWNLIGHT**

CCT 3000K | 435W | 26535lm

● structure black

Linear LED | diffused | typ cri 90 | DALI 1-100%

ceiling plate for remote driver - electrical cable length 5m | adjustable metal cable length 3m | driver (remote) | dimmer interface | ceiling attachment

customizations: optional accessories on p.98-97 and custom features on p.15

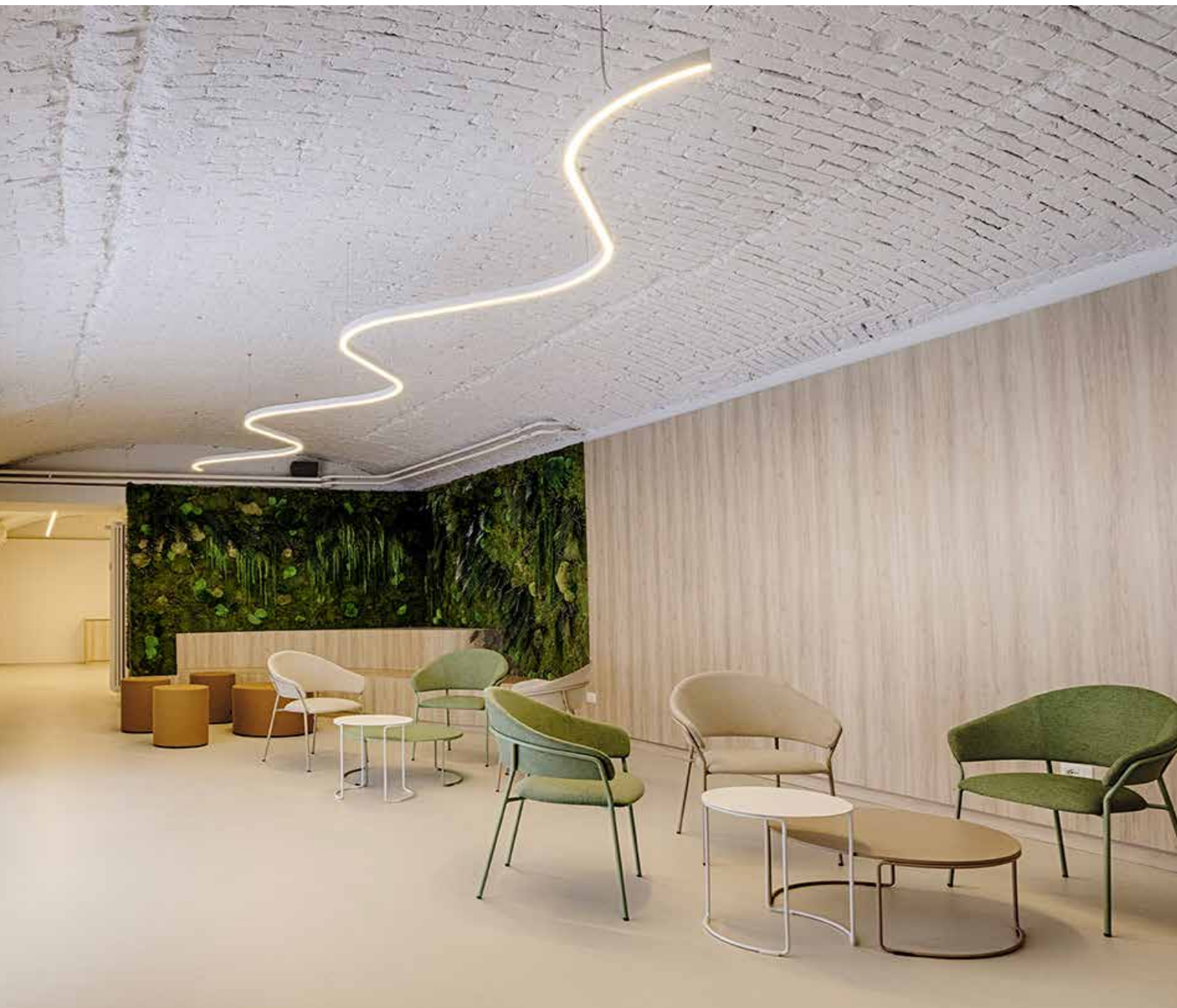

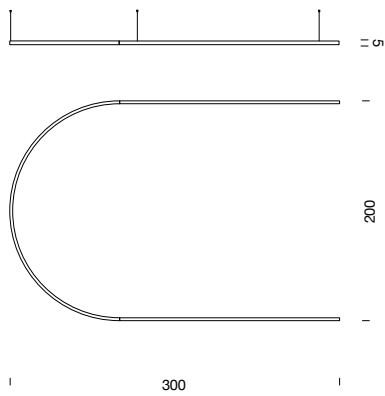
**2xL2+D2 | UP-DOWNLIGHT**

CCT 2700K | 210W | 12600lm

● structure gold

Linear LED | diffused | typ cri 90 | DALI 1-100%

1 x canopy 1 driver - electrical cable length 5m | 5 x adjustable metal cable length 3m | dimmer interface | 5 x ceiling attachment

customizations: optional accessories on p.98-97 and custom features on p.15



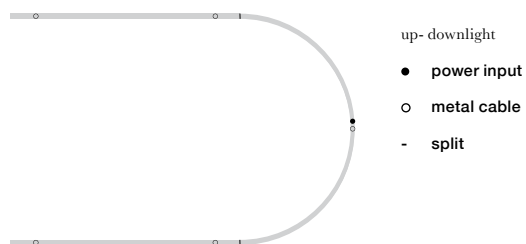

Zirkol Custom 2xL2+D2, gold.  
 Private project, Lyon





Zirkol Custom 2xL2+D2, gold.  
Galerie Lafayette Haussmann, Paris

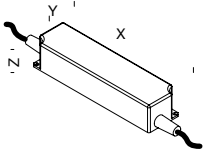

**DRIVER**

input voltage	output voltage	max power	switching	IP	dimensions cm	code
220/240V	24VDC	20W	ON/OFF	20	10,3x3,5x1,6	WPSU20W24V
220/240V	24VDC	60W	ON/OFF	20	18x5,2x3	WPSU60W24V
110/240V	24VDC	75W	ON/OFF	67	14x6,3x3,2	WPSU75W24VIP
110/240V	24VDC	100W	ON/OFF	67	14x6,3x3,2	WPSU100W24VIP
110/240V	24VDC	150W	ON/OFF	20	17,9x6,2x3	WPSU150W24V
200/240V	24VDC	250W	ON/OFF	20	19,5x6,7x3,2	WPSU250W24V
220/240V	24VDC	75W	TRIAC	20	21,2x5,4x3,3	WPSTNS75W24V
220/240V	24VDC	60W	DALI2	20	36,1x3x2,1	WPSD60W24V
110/240V	24VDC	120W	DALI2	67	19,1x6,3x3,8	WPSU120W24VIP
220/240V	24VDC	150W	DALI2/PUSH	20	35x3x2	WPSD150W24V
note	more information on p. 326 of the catalog					

**DIMMER INTERFACE**

**WIRED**

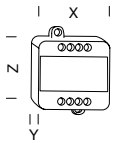

dimensions x,y,z	max power	voltage	switching	code
4,4x5,7x2,5	240W	24V	0-10V   1-10V   PUSH   DALI*	WDIMDALIHP
note	*to combine with driver ON/OFF			

**WIRELESS**

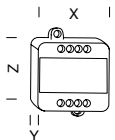

dimensions x,y,z	max power	voltage	switching	code
4,4x5,7x2,5			CASAMBI   PUSH*	WBLTSMART
note	*to combine with driver ON/OFF, on board (HOME version) or external mounting, iOS and Android compatible, set up by customer or by ILTI LUCE on commission			

**REMOTE CONTROL KIT**

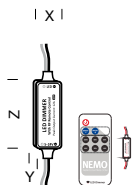

dimensions x,y,z	max power	voltage	switching	code
1,2x0,5x5	120W	5V - 24V	REMOTE	WDIMKITREM
note	mono channel dimmer for LED with RF (radio frequency) wireless remote control , to be used as dimming solution in place of specific wiring			



## ZIRKOL OPTIONAL ACCESSORIES

### CEILING ATTACHMENT



version	finish	code
1 piece	chrome	BROSMINIST

### CEILING PLATE FOR REMOTE DRIVERS

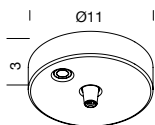

version	finish	code
surface application	white	BROSRONDBI
	black	BROSRONDNE
	gold	BROSRONDOR
recessed application	white	BROSINCB I
	black	BROSINCNE
	gold	BROSINCOR
note	to be used for decentralized solutions or remote mounting driver	

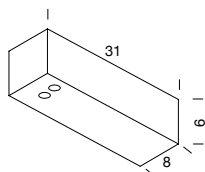
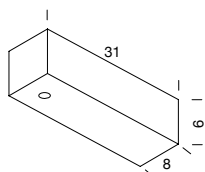

### DRIVER BOX

version	finish	code
1 driver-1 electrical cable	white	BROSPS1BI
	black	BROSPS1NE
	gold	BROSPS1OR
1 driver-2 electrical cables	white	BROSPS2BI
	black	BROSPS2NE
	gold	BROSPS2OR

## CEILING/PENDANT

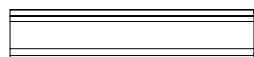

100/200/300



3,2

## RECESSED

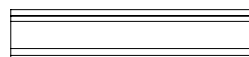

100/200/300

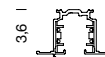

5,6

## TRACK 3C-230V

version	voltage	switching	mounting	finish	code
1m	230V	ON/OFF / TRIAC / CASAMBI / DIMMER ON BOARD	ceiling, pendant	white	MTRK0110BI
1m	230V	ON/OFF / TRIAC / CASAMBI / DIMMER ON BOARD	ceiling, pendant	black	MTRK0110NE
2m	230V	ON/OFF / TRIAC / CASAMBI / DIMMER ON BOARD	ceiling, pendant	white	MTRK0120BI
2m	230V	ON/OFF / TRIAC / CASAMBI / DIMMER ON BOARD	ceiling, pendant	black	MTRK0120NE
3m	230V	ON/OFF / TRIAC / CASAMBI / DIMMER ON BOARD	ceiling, pendant	white	MTRK0130BI
3m	230V	ON/OFF / TRIAC / CASAMBI / DIMMER ON BOARD	ceiling, pendant	black	MTRK0130NE
1m	230V	ON/OFF / TRIAC / CASAMBI / DIMMER ON BOARD	recessed	white	MTRK0310BI
1m	230V	ON/OFF / TRIAC / CASAMBI / DIMMER ON BOARD	recessed	black	MTRK0310NE
2m	230V	ON/OFF / TRIAC / CASAMBI / DIMMER ON BOARD	recessed	white	MTRK0320BI
2m	230V	ON/OFF / TRIAC / CASAMBI / DIMMER ON BOARD	recessed	black	MTRK0320NE
3m	230V	ON/OFF / TRIAC / CASAMBI / DIMMER ON BOARD	recessed	white	MTRK0330BI
3m	230V	ON/OFF / TRIAC / CASAMBI / DIMMER ON BOARD	recessed	black	MTRK0330NE

CE UK IP20

**TRACK 3C-230V ACCESSORY**

version	voltage	switching	mounting	finish	code
Track Start DX	230V	ON/OFF / TRIAC /CASAMBI /DOB	ceiling, pendant, recessed	white	MTRKADX0BBI
Track Start DX	230V	ON/OFF / TRIAC /CASAMBI /DOB	ceiling, pendant, recessed	black	MTRKADX0BNE
Track Start SX	230V	ON/OFF / TRIAC /CASAMBI /DOB	ceiling, pendant, recessed	white	MTRKASX0BBI
Track Start SX	230V	ON/OFF / TRIAC /CASAMBI /DOB	ceiling, pendant, recessed	black	MTRKASX0BNE
Straight Coupler	230V	ON/OFF / TRIAC /CASAMBI /DOB	ceiling, pendant, recessed	white	MTRKJL0BBI
Straight Coupler	230V	ON/OFF / TRIAC /CASAMBI /DOB	ceiling, pendant, recessed	black	MTRKJL0BNE
Flexible Coupler	230V	ON/OFF / TRIAC /CASAMBI /DOB	ceiling, pendant, recessed	white	MTRKJF0BBI
Flexible Coupler	230V	ON/OFF / TRIAC /CASAMBI /DOB	ceiling, pendant, recessed	black	MTRKJF0BNE
Track End	230V	ON/OFF / TRIAC /CASAMBI /DOB	ceiling, pendant, recessed	white	MTRKEND00BI
Track End	230V	ON/OFF / TRIAC /CASAMBI /DOB	ceiling, pendant, recessed	black	MTRKEND00NE
Cover plate	230V	ON/OFF / TRIAC /CASAMBI /DOB	recessed	white	MTRKCOVBBI
Cover plate	230V	ON/OFF / TRIAC /CASAMBI /DOB	recessed	black	MTRKCOVBNE
Cover plate cross	230V	ON/OFF / TRIAC /CASAMBI /DOB	recessed	white	MTRKCOVXBBI
Cover plate cross	230V	ON/OFF / TRIAC /CASAMBI /DOB	recessed	black	MTRKCOVXBNE
Middle feed	230V	ON/OFF / TRIAC /CASAMBI /DOB	ceiling, pendant, recessed	white	MTRKAC0BBI
Middle feed	230V	ON/OFF / TRIAC /CASAMBI /DOB	ceiling, pendant, recessed	black	MTRKAC0BNE
L feed right	230V	ON/OFF / TRIAC /CASAMBI /DOB	ceiling, pendant, recessed	white	MTRKLDX0BBI
L feed right	230V	ON/OFF / TRIAC /CASAMBI /DOB	ceiling, pendant, recessed	black	MTRKLDX0BNE
L feed left	230V	ON/OFF / TRIAC /CASAMBI /DOB	ceiling, pendant, recessed	white	MTRKLSX0BBI
L feed left	230V	ON/OFF / TRIAC /CASAMBI /DOB	ceiling, pendant, recessed	black	MTRKLSX0BNE
T Feed right up	230V	ON/OFF / TRIAC /CASAMBI /DOB	ceiling, pendant, recessed	white	MTRKTD00BBI
T Feed right up	230V	ON/OFF / TRIAC /CASAMBI /DOB	ceiling, pendant, recessed	black	MTRKTD00BNE
T Feed right down	230V	ON/OFF / TRIAC /CASAMBI /DOB	ceiling, pendant, recessed	white	MTRKTD00BBI
T Feed right down	230V	ON/OFF / TRIAC /CASAMBI /DOB	ceiling, pendant, recessed	black	MTRKTD00BNE
T Feed left up	230V	ON/OFF / TRIAC /CASAMBI /DOB	ceiling, pendant, recessed	white	MTRKTS00BBI
T Feed left up	230V	ON/OFF / TRIAC /CASAMBI /DOB	ceiling, pendant, recessed	black	MTRKTS00BNE
T Feed left down	230V	ON/OFF / TRIAC /CASAMBI /DOB	ceiling, pendant, recessed	white	MTRKTS00BBI
T Feed left down	230V	ON/OFF / TRIAC /CASAMBI /DOB	ceiling, pendant, recessed	black	MTRKTS00BNE
X Feed	230V	ON/OFF / TRIAC /CASAMBI /DOB	ceiling, pendant, recessed	white	MTRKX0BBI
X Feed	230V	ON/OFF / TRIAC /CASAMBI /DOB	ceiling, pendant, recessed	black	MTRKX0BNE

**3PHASE ACCESSORY (ON/OFF-TRIAC)**

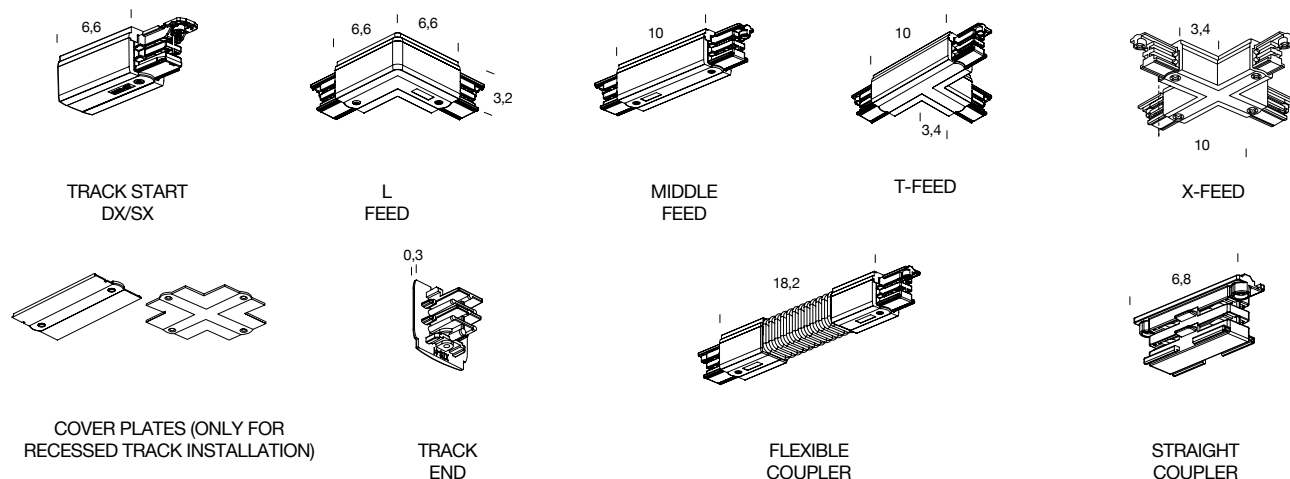

**TRACK 3C-230V ACCESSORY**

version	voltage	switching	mounting	finish	code
Clip	230V	ON/OFF	ceiling, pendant	white	MTRKCL00BI
Clip	230V	ON/OFF	ceiling, pendant	black	MTRKCL00NE
Steel Clable 1,5m	230V	ON/OFF	pendant	white	MTRKCAB0015BI
Steel Clable 1,5m	230V	ON/OFF	pendant	black	MTRKCAB0015NE
Steel Clable 3m	230V	ON/OFF	pendant	white	MTRKCAB0030BI
Steel Clable 3m	230V	ON/OFF	pendant	black	MTRKCAB0030NE
Suspension nut M6	230V	ON/OFF	pendant		MTRKNUT

**3PHASE /ACCESSORY**

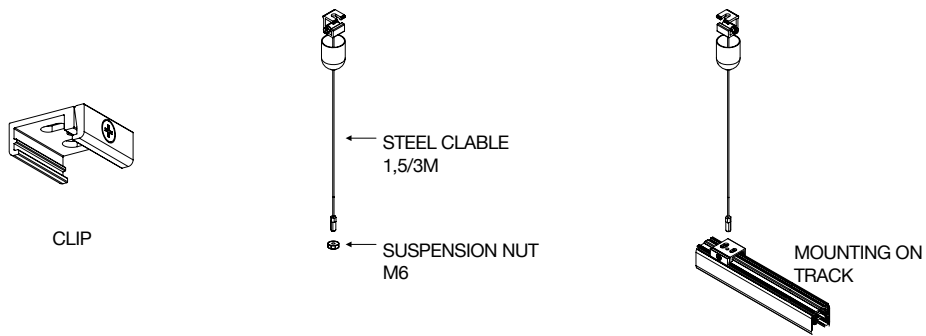

**POLARITY INSTRUCTIONS**

ON/OFF-TRIAC EXAMPLE

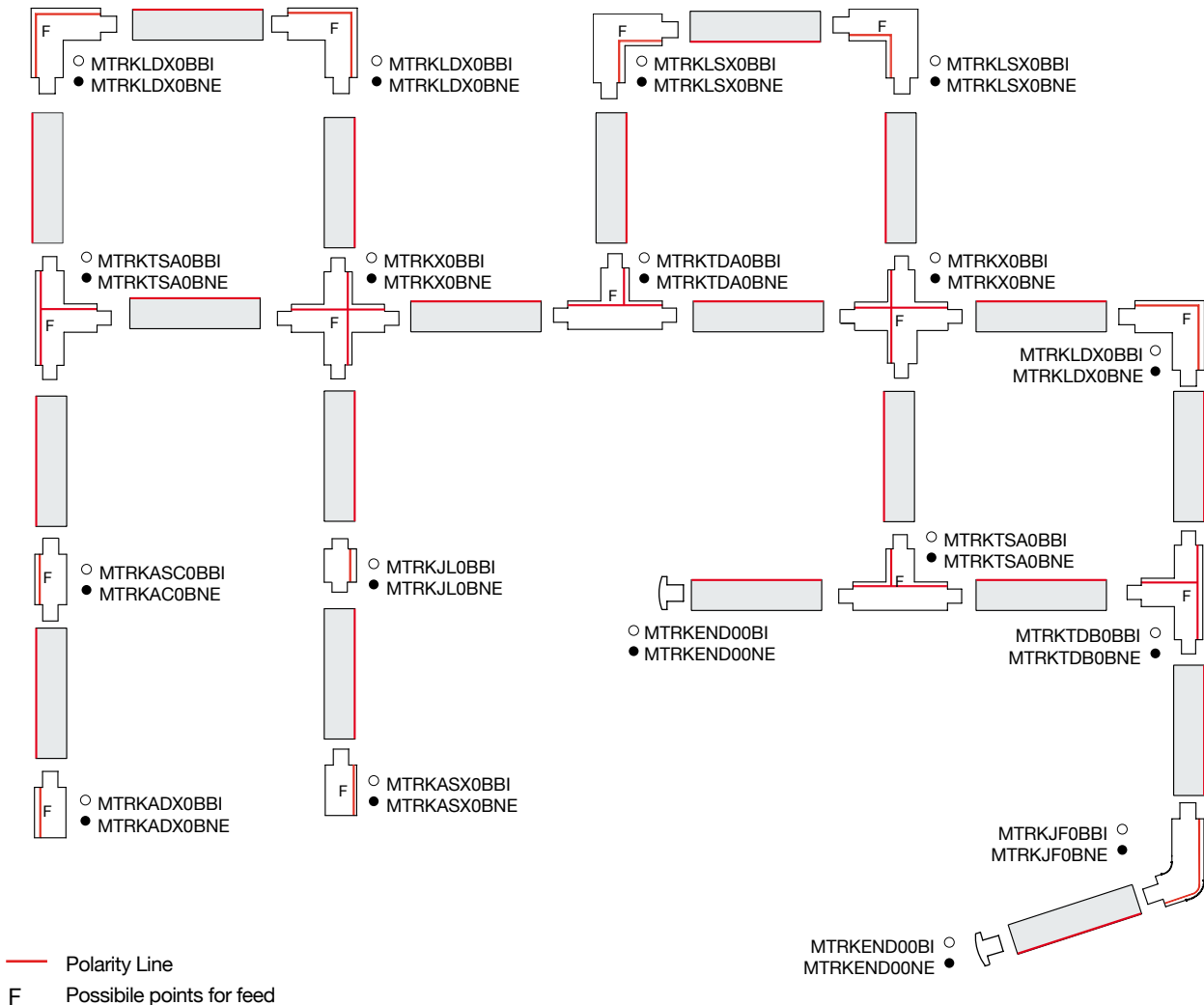



# CREDITS

- Zirkol Circle at Hages Badehotel, Rødby – p.20
- Zirkol Circle at Private Project, Manchester - Project: Vivo Casa.  
Ph. Peter Corcoran – p.29
- Zirkol Circle, Zirkol Square and Zirkol Linear at “VITA DULCIS. Paura e desiderio nell’impero romano”, Palazzo delle Esposizioni, Rome, 22 aprile – 27 agosto 2023. ©2023 Azienda Speciale Palaexpo. Ph. Daniele Molajoli – p.7-8
- Zirkol custom at Domal showroom, Milan - Project: Lascia la Scia, Works management: Federica Allevi – p.91
- Zirkol Square Q custom custom at La Cave, Galerie Lafayette Haussmann, Paris - Project management: Groupe Duclot Studio: Trace & Associés Architectes. Light designer: Vincent Péron – Vip Lighting Ph. Benjamin Deroche – p.94
- Zirkol custom at Nexer Office. Ph. James Silverman – p.86
- Zirkol Oval at private residence, Pinzolo - Project: Offstage.  
Ph. Simone Furiosi – p.64
- Zirkol Square Q custom at Society Café, Dubai  
Project: XO Atelier. Ph. Alex Jeffries – p.56
- Zirkol Square S at Stanford University, Florence - Project: Cloro Studio - Pier Paolo Carta and Valeria Zammarchi.  
Ph. Fabio Bascetta – p.55

## ART DIRECTION AND GRAPHIC DESIGN

Guillaume Bloget and ILTI Luce

## PHOTOS

Alberto Strada  
Marcello Perego

## LOCATION

Musée départemental de la Préhistoire, Nemours (France)  
Private Residence, Milan (Italy)  
The cultural and sports center Wangari Maathai, Paris (France)  
Borgonuovo19, Milan (Italy)

**EDITION**  
April 2024

# GENERAL INFORMATION

## IT

Obiettivo di ILTI LUCE è quello di proporre soluzioni tecnologiche all'avanguardia, anche tramite un continuo e costante processo di aggiornamento. Per definizione la tecnologia è mutevole ed in costante evoluzione. Sugeriamo, per assicurare la consultazione delle informazioni più recenti sui prodotti, di verificare quelle disponibili sul nostro website [www.iltiluce.com](http://www.iltiluce.com). Questo documento è stato redatto a Marzo 2024. Sostituisce ed aggiorna qualsiasi altra pubblicazione in relazione ai prodotti elencati.

A causa di naturali limiti tecnici di riproduzione e stampa, il colore dei modelli a catalogo è puramente indicativo e non può costituire motivo di rivalsa.

Ove non espressamente scritto, le lampadine non sono incluse nella vendita.

## EN

ILTI LUCE's goal is to propose cutting-edge technological solutions, also through a constant updating process.

By definition, technology is changing and continuously evolving. To ensure the consultation of the latest product data, we recommend referring to the information available on our website [www.iltiluce.com](http://www.iltiluce.com). This document was drafted in March 2024. It replaces and updates any other publication in relation to the listed products. Due to natural technical limitations of reproduction and printing, the colour of the models in the catalogue is purely indicative and cannot constitute grounds for recourse.

Unless expressly stated, light bulbs are not included in the sale.

## DE

Das Ziel von ILTI LUCE ist die Entwicklung von technologischen Lösungen auf dem neuesten Stand, auch durch einen ständigen Aktualisierungsprozess. Die Technik entwickelt sich ständig weiter. Um die aktuellsten Produktunterlagen einzusehen, empfehlen wir, sich auf die Informationen auf unserer Website [www.iltiluce.com](http://www.iltiluce.com) zu beziehen. Dieses Dokument wurde im März 2024 verfasst. Es ersetzt und aktualisiert alle anderen Veröffentlichungen in Bezug auf die aufgeführten Produkte.

Aufgrund der technischen Grenzen der Reproduktion und des Drucks sind die Farben der im Katalog abgebildeten Modelle rein indikativ und können nicht als Reklamationsgrund dienen. Sofern nicht ausdrücklich angegeben, sind die Glühbirnen nicht im Verkauf enthalten.

## FR

L'objectif de ILTI LUCE est de proposer des solutions technologiques

de pointe, également à travers un processus de mise à jour constante. Par définition, la technologie évolue et change continuellement. Pour garantir la consultation des dernières données produits, nous vous recommandons de vous référer aux informations disponibles sur notre site [www.iltiluce.com](http://www.iltiluce.com).

Ce document a été établi en Mars 2024. Il remplace et met à jour toute autre publication relative aux produits cités.

En raison des limites techniques naturelles de reproduction et d'impression, la couleur des modèles du catalogue est purement indicative et ne peut constituer un motif de réclamation. Sauf mention expresse, les ampoules ne sont pas comprises dans la vente.

## IT

L'elenco aggiornato dei prodotti con marchio UL ed ETL e le relative informazioni tecniche sono disponibili sul sito website: [nemolighting.com/usa/](http://nemolighting.com/usa/)

## EN

The updated list of UL and ETL marked products and relevant technical information are available on the website: [nemolighting.com/usa/](http://nemolighting.com/usa/)

## DE

Die aktualisierte Liste der UL- und ETL-zertifizierten Produkte und die entsprechenden technischen Informationen finden Sie auf der Website: [nemolighting.com/usa/](http://nemolighting.com/usa/)

## FR

La liste actualisée des produits marqués UL et ETL et les informations techniques correspondantes sont disponibles sur le site web : [nemolighting.com/usa/](http://nemolighting.com/usa/)



Photometric data and more information available on our website:

[www.iltiluce.com](http://www.iltiluce.com)



Scan the code for Terms & Conditions

# ILTI LUCE

## ILTI LUCE

Strada Borgata Paradiso, 20  
10036 Settimo Torinese - ITALY  
Tel. +39 011 765 73 01  
info@iltiluce.com

[www.iltiluce.com](http://www.iltiluce.com)

Part of

## NEMO Group

### NEMO SHOWROOM MONFORTE

Corso Monforte 19/A,  
20122 Milan  
Tel +39 02 970 703 40  
[monforte@nemolighting.com](mailto:monforte@nemolighting.com)

### NEMO GALERIE PARIS

44, Rue du Bac  
75007 Paris  
Tel +33 (0) 1 486 318 42  
[ruedubac@nemolighting.fr](mailto:ruedubac@nemolighting.fr)

### NEMO USA

625 Jersey Avenue, Unit 7  
New Brunswick, NJ 08901  
Tel +1 800 734 5858  
[usa@nemolighting.com](mailto:usa@nemolighting.com)  
[nemolighting.com/usa/](http://nemolighting.com/usa/)

### NEMO COPENHAGEN

Store Kongensgade 118  
1264 København  
Denmark





