

soundbarrier®

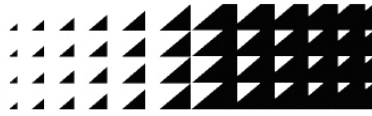

DP SERIES

PROFESSIONAL DIGITAL SPEAKER PROCESSOR

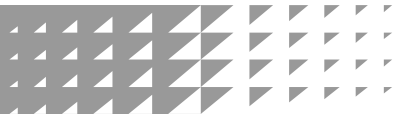

Owner's Manual

SB-DP48A



SB-DP62A



Before attempting to connect, operate or adjust this product, please read these instructions completely

PROFESSIONAL DIGITAL AUDIO PROCESSOR

User Guide

Thank you for selecting our products.
Please read this manual carefully to get the most out of your new unit.

Caution: Do not let this unit touch the rain or get wet, to avoid the fire or electric shock.

CONTENTS

Front Panel and Rear Panel Controls and Connectors	1
Specification	2
Panel Operation	3
Input parameter setting	3
Output parameter setting	6
System Parameter setting	10
PC Software Operation	11
Single Processor Connection	16
Many Processors Connection	18

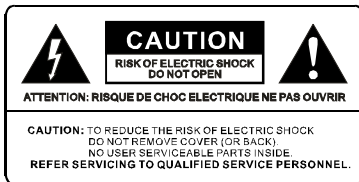

An equilateral triangle enclosing a lightning flash/arrowhead symbol is intended to alert the user to the presence of un-insulated "dangerous voltage" within the product's enclosure which may be of sufficient magnitude to constitute a risk of electric shock.



An equilateral triangle enclosing an exclamation point is intended to alert the user to the presence of important operating and service instructions in the literature enclosed with this unit.

IMPORTANT SAFETY INSTRUCTIONS

IMPORTANT SAFETY INSTRUCTIONS

WARNING - When using electric products, basic precautions should always be followed, including the following:

1. Read all the instructions before using the product.
2. Do not use this product near water (e.g., near a bathtub, washbowl, kitchen sink, in a wet basement, near a swimming pool, etc.).
3. This product should be used only with a cart or stand that will keep it level and stable and prevent wobbling.
4. This product, in combination with headphones or speakers, may be capable of producing sound levels that could cause permanent hearing loss. Do not operate for a long period of time at a high volume level or at a level that is uncomfortable. If you experience any hearing loss or ringing in the ears, you should consult an audiologist.
5. The product should be located so that its location or position does not interfere with its proper ventilation.
6. The product should be located away from heat sources such as radiators, heat vents, or other devices (including amplifiers) that produce heat.
7. The product should be connected to a power supply only of the type described in the operating instructions or as marked on the product. Replace the fuse only with one of the specified type and size and with the correct rating.
8. The power-supply cord should: (1) be undamaged, (2) never share an outlet or extension cord with other devices so that the outlet's or extension cord's power rating is exceeded, or (3) be left plugged into the outlet when left unused for a long period of time.
9. Care should be taken so that objects do not fall into and liquids are not spilled through the enclosure's openings.
10. The product should be serviced by qualified service personnel when:
 - A. The power-supply cord or the plug has been damaged; or
 - B. Objects have fallen, or liquid has been spilled onto the product; or
 - C. The product has been exposed to rain; or
 - D. The product does not appear to operate normally or exhibits a marked change in performance; or
 - E. The product has been dropped, or the enclosure damaged.
11. Do not attempt to service the product beyond that described in the user-maintenance instructions. All other servicing should be referred to qualified service personnel.

IMPORTANT SAFETY INSTRUCTIONS

This product may be equipped with a polarized line plug (one blade wider than the other). This is a safety feature. If you are unable to insert the plug into the outlet, contact an electrician to replace your obsolete outlet. Do not defeat the safety purpose of the plug. (For use in the U.S.A.)

IMPORTANT: THE WIRES IN THIS MAINS LEAD ARE COLORED IN ACCORDANCE WITH THE FOLLOWING CODE.

BLUE: NEUTRAL / BROWN: LIVE

As the colors of the wires in the mains lead of this apparatus may not correspond with the colored markings identifying the terminals in your plug proceed as follows: The wire which is colored BLUE must be connected to the terminal which is marked with the letter N or colored BLACK. The wire which is colored BROWN must be connected to the terminal which is marked with the letter L or colored RED. Under no circumstances must either of the above wires be connected to the ground terminal of a three-pin plug.

(For use in Europe)

Front Panel Controls and Connectors

Front panel

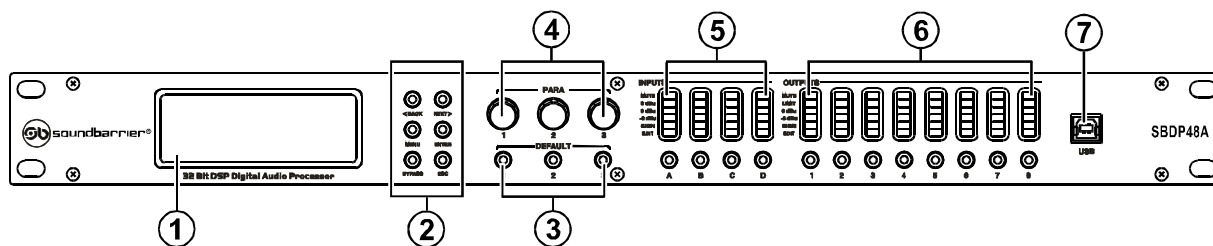

- ① LCD Display: Display the parameters and menu
- ② Function select
- ③ Default: 3 DEFAULT keyboard shortcuts, mostly adjust using the PROGRAM
- ④ Substitute control key
- ⑤ Input LED meter from the top to down: **MUTE 6 dBu 0 dBu -6 dBu SIGN EDIT**
- ⑥ Output LED meter from the top to down: **MUTE LIMIT 0 dBu -6 dBu SIGN EDIT**
- ⑦ USB connector: Connect with the PC in close quarters

Rear panel

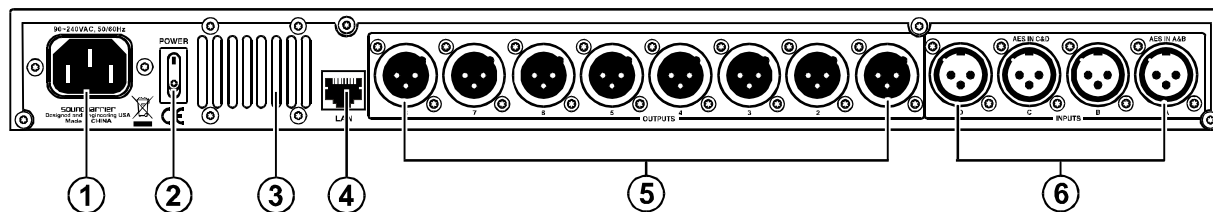

- ① Power Cord
- ② Power Switch
- ③ Ventilation Hole
- ④ LAN connector
- ⑤ OUTPUT Connectors: These XLR-3-32 Balanced connectors output each channel analog audio signals
- ⑥ INPUT Connectors: These XLR-3-31 Balanced connectors input each channel analog audio signals
(NOTICE: AES DIGITAL INPUTS can connect A or C connectors only, but not B or D connectors .)

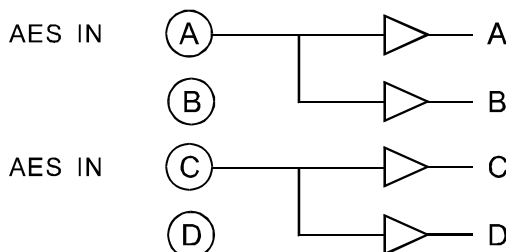

Specification

Features

- * Use 32 bits floating point unit, made the operation precision more higher.
- * Use 96KHz sampling frequency, one time higher than the similar products in the market. Sound more nicety, less distortion.
- * PC long-distance control by using the attached software:
short distance can be controlled by 、 USB connector or RJ45(LAN) connector.
Long-distance control through RJ45(LAN) connector.
It can control maximum 250 pcs products, maximum distance 100 meters.
(It depends on the electromagnetic environment.)

Specification

Characteristic specification

Impedance	>10k ohms.
CMRR	>65dB, 50Hz - 10kHz.
Output impedance	<60 ohms
The minimum loading impedance	600 ohms
The maximum output level	+20dBm (600 ohms loading)
Frequency reponse	± 0.5 dB 20Hz - 20kHz.
Dynamic range	>110dB 20Hz -20kHz
Distortion	< 0.02% @ 1kHz, +18dBm.
The maximum delay	650 mS. (adjustable step distance is 2.6uS)
Output gain	Setting range:-40dB~+15dB,Step pitch: ± 0.1 dB
Input gain	Setting range:-40dB~+6dB,Step pitch: ± 0.1 dB

Parameter equalizer

Filter	6 bands/each output, 8 bands/each input
Filter gain	+15dB to -30dB, the step distance is 0.1dB
Central frequency	20Hz - 20kHz,the adjustable step distance is 1/36 octave.(368 positions)
Filter	Q value/band width 0.4 to 28.8 / 3 to 0.05
Switch to high, low pass frequency	
Low frequency transition frequency	20Hz - 1kHz
high frequency transition frequency	1kHz - 20kHz
Gain	± 15 dB, adjustable step distance is 0.1dB

High pass and low pass filter

Filter	each output with one filter
Transition frequency (high pass)	10Hz - 16kHz,adjustable step distance is 1/36 octave
Transition frequency (low pass)	60Hz - 22kHz,adjustable step distance is 1/36 octave
Selectable filter type:	Link-Riley、 Bessel、 Butterworth

Limiter

Threshold range	+20dBu to -10dBu
Start-up time	0.3 to 90ms
Release time	start-up time 4, 8,16 or 32 times

Panel Operation

Input Parameter Setting:

Long press (about 3 seconds) “IN A /IN B /IN C /IN D” ,and then the relevant channel into Edit status, yellow light displays. (Each channel default for mute), Short press relevant function key set the parameter setting, press “<BACK” and “NEXT>” select function setting, short press “ENTER” confirm relevant parameter.

1.Name Setting:

{Example} 1、 Press A channel key about 3 seconds till the yellow light displays, into Edit status.

Display as below:

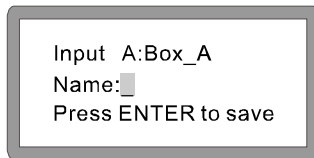

2、 Turn the first knob of “PARA” select figure or letter, the second knob for select next one. Press ENTER for confirm and save.

2. Input Delay Setting:

【Parameter】 Delay, adjust range: 0ms~1000ms, 0Meter~346Meter, 0Feet~1134.88Feet.

Each channel has unattached delay control.

{Example} 1、 Press A channel key about 3 seconds till the yellow light displays, into Edit status.

2、 Press “<BACK” or “NEXT>” , switch to Delay.

Display as below:

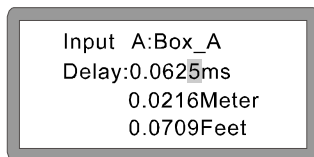

3、 Turn the first knob of “PARA” for fine adjustment , the second knob for rough adjustment.
(Turn the knob clockwise,the value increase; Turn the knob withershine,the value decrease.)

3. Input POLARITY setting:

【Parameter】 Polarity, [+Normal]: Positive [-Invert]: Negative pole.Each channel has unattached phase control.

{Example} 1、 Press A Channel key about 3 seconds till the yellow light displays, into Edit status.

2、 Press “<BACK” or “NEXT>” , switch to Polarity.

Display as below:

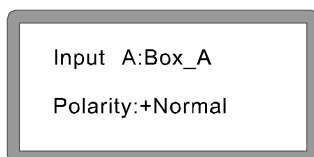

3、 Turn the first knob of “PARA” for change the Polarity.

Panel Operation

4. Input Gain Setting:

【Parameter】 Gain, adjust range: -40.0dB~+6.0dB, step pitch is 0.1dB. Each channel has unattached gain control

- {Example} 1、 Press A channel key about 3 seconds till the yellow light displays, into Edit status.
2、 Press “<BACK” or “NEXT>” , switch to Gain

Display as below:

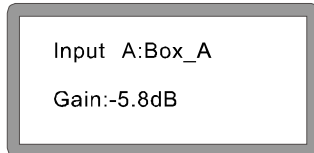

- 3、 Turn the first knob of “PARA” for change the value.

(Turn the knob clockwise, the value increase; Turn the knob withershins, the value decrease.)

5. EQ setting:

【Parameter】 EQ, IN A~IN D Each channel can set 8 parameter EQ (EQ1~EQ8) .

A: At Parameter status: Freq: 20Hz~20KHz
Gain: -20dB~+20dB
Bandwidth: 0.05/Oct~3/Oct

B: At Lo_Shelf、Hi-shelf status:
Freq: 20Hz~20KHz
Gain: -30dB~+15dB
Slope: +6dB、+12dB

- {Example} 1、 Press A channel key about 3 seconds till the yellow light displays, into Edit status.
2、 Press “<BACK” or “NEXT>” , switch to EQ, into “Parameter” setting status.

Display as below:

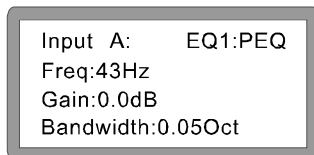

- 3、 Turn the first knob of “PARA” , switch to “Lo-shelf” or “Hi-shelf” setting status,
Press ENTER for confirm.

Display as below:

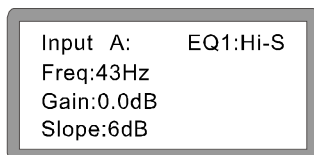

Panel Operation

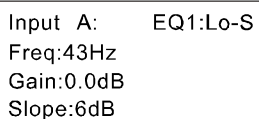

Input A: EQ1:Lo-S
Freq:43Hz
Gain:0.0dB
Slope:6dB

- 4、 Press “ENTER” , confirm select “Lo-shelf” status, into parameter setting. Turn the first knob of “PARA” for adjust the gain value, Turn the second knob for adjusting Freq, Turn the third knob for select slope. (Turn the knob clockwise, the value increase; Turn the knob withershins, the value decrease.

Display as below:

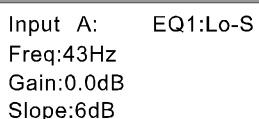

Input A: EQ1:Lo-S
Freq:43Hz
Gain:0.0dB
Slope:6dB

- 5、 Press “<BACK” or “NEXT>” , can switch among EQ1~EQ8, the setting method is same.

6. Noisegate Setting:

【Parameter】 Noisegate. Range: -120dBu~+10dBu, Each channel has unattached Noisegate control.

{Example} 1、 Press A channel about 3 seconds till the yellow light displays, into Edit status.

- 2、 Press “<BACK” or “NEXT>” , switch to Noisegate

Display as below:

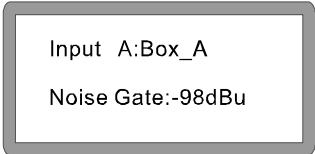

Input A:Box_A
Noise Gate:-98dBu

- 3、 Turn any knob of “PARA” can adjust setting.
(Turn the knob clockwise, the value increase; Turn the knob withershins, the value decrease.)

Panel Operation

Output Parameter Setting:

Long press (about 3 seconds) “OUT1 ~ OUT8” ,the relevant channel yellow light displays, into Edit status. Each channel default to mute).Short press the relevant function key can into the parameter setting menu. Press “<BACK” and “NEXT>” to select function setting, short press ENTER to confirm the relevant parameter.

1.Name Setting:

{Example} 1、 Press Out1 channel for 3 seconds till the yellow light displays, into Edit status of Out1.

Display as below:

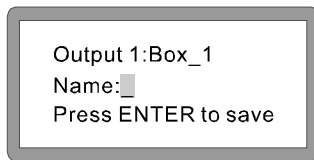

2、 Turn the first knob of “PARA” to select figure or letter, the second knob to select next one, press ENTER to confirm and save.

2. Signal Source Setting:

{Example} 1、 Press Out1 channel for 3 seconds till the yellow light displays, Into Edit status of Out1.

Display as below:

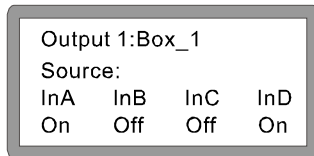

2、 Turn the first knob of “PARA” to select On or Of, press ENTER to confirm.

3.Output Gain Setting:

【Parameter】 Gain, adjust range: -40.0dB~+15.0dB, step pitch is 0.1dB. Each channel has unattached gain control.

{Example} 1、 Press Out1 channel for 3 seconds till yellow light displays, into Edit status of Out1.

2、 Press “<BACK” or “NEXT>” , switch to Gain

Display as below:

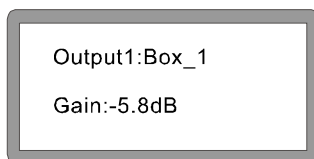

3、 Turn the first knob of “PARA” to change the value.

(Turn the knob clockwise, the value increase; Turn the knob withershines, the value decrease.)

Panel Operation

4. Output POLARITY setting:

【Parameter】 Polarity, [+Normal]: Positive [-Invert]: negative. Each channel has unattached phase control.

{Example} 1、 Press Out1 channel key for 3 seconds till yellow light displays, into Edit status of Out1.

2、 Press “<BACK” or “NEXT>” , switch to Polarity

Display as below:

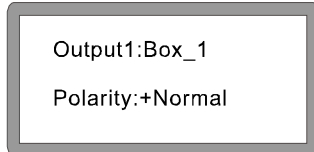

3、 Turn the first knob of “PARA” to change the polarity.

5. Output Delay Setting:

【Parameter】 Delay, adjust range: 0ms~1000ms, 0Meter~346Meter, 0Feet~1134.88Feet.

Each channel has unattached delay control.

{Example} 1、 Press Out1 channel for 3 seconds till yellow light displays, into Edit status of Out1.

2、 Press “<BACK” or “NEXT>” , switch to Delay

Display as below:

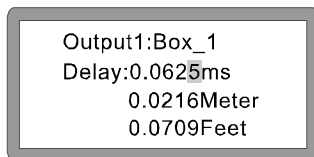

3、 Turn the first knob of “PARA” to fine adjustment, Turn the second knob to rough adjustment.

(Turn the knob clockwise, the value increase; Turn the knob withershins, the value decrease . .)

6. Crossover HPF Setting:

【Parameter】 HPF, Highpass, Range: 20Hz~20KHz, Selectable filter type: Link-Riley、 Bessel、

Butterworth. Selectable slope: 12dB、 18dB、 24dB、 48dB. Each channel has

unattached highpass filter.

{Example} 1、 Press Out1 channel for 3 seconds till yellow light displays, into Edit status of Out1.

2、 Press “<BACK” or “NEXT>” , switch to HPF

Display as below:

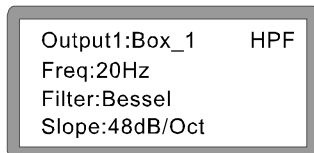

3、 Turn the first knob of “PARA” to adjust value (Turn the knob clockwise, the value increase; Turn the knob withershins, the value decrease.) , Turn the second knob to select filter type, Turn the third knob to select slope.

Panel Operation

7.Crossover LPF Setting:

【Parameter】 LPF, Lowpass. Range: 20Hz~20KHz, Selectable filter type: Link-Riley、Bessel、Butterworth.Selectable slope: 12dB、18dB、24dB、48dB. Each channel has unattached lowpass filter.

{Example} 1、 Press Out1 channel key for 3 seconds till yellow light displays, into Edit status of Out1.
2、 Press “<BACK” or “NEXT>” , switch to LPF

Display as below:

```
Output1:Box_1   LPF
Freq:20Hz
Filter:Bessel
Slope:48dB/Oct
```

3、 Turn the first knob of “PARA” adjust value (Turn the knob clockwise, the value increase; Turn the knob withershins, the value decrease.), Turn the second knob of “PARA” to select filter type, Turn the third knob to select slope..

8.EQ Setting:

【Parameter】 EQ, Out1~Out8 Each channel can set 6 parameter EQ (EQ1~EQ6).

A: At Parameter status: Freq: 20Hz~20KHz
Gain: -20dB~+15dB
Bandwidth: 0.05/Oct~3/Oct

B: At Lo_Shelf、Hi-shelf status:
Freq: 20Hz~20KHz
Gain: -30dB~+15dB
Slope: +6dB、+12dB

{Example} 1、 Press Out1 channel for 3 seconds till yellow light displays, into Edit status of Out1.
2、 Press “<BACK” or “NEXT>” , switch to EQ, into “Parameter” setting status.

Display as below:

```
Output1:   EQ1:PEQ
Freq:43Hz
Gain:0.0dB
Bandwidth:0.05Oct
```

3、 Turn the first knob of “PARA” , can switch to “Lo-shelf” or “Hi-shelf” setting status.
Press ENTER to confirm.

Display as below:

```
Output1:   EQ1:Hi-S
Freq:43Hz
Gain:0.0dB
Slope:6dB
```

Panel Operation

```
Output1:   EQ1:Lo-S
Freq:43Hz
Gain:0.0dB
Slope:6dB
```

- 4、 Press “ENTER” , confirm select “Lo-shelf” , into parameter setting. Turn the first knob of “PARA” to adjust gain value, Turn the second knob to adjust Freq, Turn the third knob to select slope. (Turn the knob clockwise, the value increase; Turn the knob withershins, the value decrease.)

Display as below:

```
Output1:   EQ1:Lo-S
Freq:43Hz
Gain:0.0dB
Slope:6dB
```

- 5、 Press “<BACK” or “NEXT>” , can switch among EQ1~EQ6, the setting method is same.

9.LIMITER Setting:

【Parameter】 Limiter, Out1~Out8 Each channel has unattached limiter control.

Threshold value: -30dBu~20dBu Attack: 0.3ms~100ms

Release: 2x、 4x、 6x、 8x、 16x、 32x

- {Example} 1、 Press Out1 channel for 3 seconds till yellow light displays, into Edit status of Out1.
2、 Press “<BACK” or “NEXT>” , switch to Limit or Compressor, Press ENTER to confirm.

A:If select Limit, Display as below:

```
Output1:Box_1
Mode:Limit
Threshold:-30.0dBu
Att:45ms        Rel: 8x
```

- 3、 Turn the first knob of “PARA” to change the threshold value, Turn the second knob to set the attack time; Turn the third knob to set the release time (Can set 2, 4, 6, 8, 16, 32 times as Attack time). The Compressor setting method is same.

B:If you select Compressor, please press “NEXT>” , Have setting as below: :Compressor, have Manual or Auto can be selectable.

Cliplim Adjust Range: 2.0dB~12dB Ratio: have 1:1、 1:2、 1:4、 1:8、 1:16、 1:32、 1:64、

1:Maximum to be selectable. (Use the first、 second、 third knob to adjust)

Display as below:

```
Output1:Box_1
Compressor:Manual
Clim:2.0dB    Above
Ratio:1:8
```

Panel Operation

System Parameter Setting:

All the setted parameter can be saved in the memorizer for use the same mode in the future. Short press the "MENU" into function selecting; Press "BACK", "NEXT" or turn any knob of "PARA" to go forward or back. Short press "ENTER" into relevant function parameter setting. Turn any knob of "PARA" to set relevant parameter; short "ENTER" to confirm, the "Esc" key is escape.

Main Menu:

- 1、Xover SubMenu ➡ 1、 Load Program 2、 Store Program 3、 Erase Program
- 2、 Program Copy ➡ Turn any knob of "PARA" to select Program Copy.
- 3、 Channel Copy ➡ Turn any knob of "PARA" to select each Channel Copy.
- 4、 Input SubMenu ➡ Turn any knob of "PARA" to select Input Source of Input Channel A~D.
- 5、 Security SubMenu ➡ Turn any knob of "PARA" to set password.
- 6、 System SubMenu ➡
 - 1、 Backlight Setup ➡ Set the LCD backlight for long display display or auto close for 25 seconds.
 - 2、 System Info ➡ Press "ENTER" to check System Info.
 - 3、 Temperature ➡ Turn any knob of "PARA" to set temperature.
 - 4、 Filter Display ➡ Turn any knob of "PARA" to select BW/Q.
 - 5、 Scene Change ➡ Hotkey Enable/Disable
 - 6、 Scene Key Setup
 - 7、 wifi Factory Reset ➡ Turn any knob of "PARA" to select Yes/No

PC Software Operation

DSP series digital speaker processor use advanced Long-distance control technology, it can set all the functions and controlled by connection software. It has strong function and steady quality. Short distance can be controlled by USB connector or LAN connector; Long-distance controlled by LAN connector; It can control maximum 250 purchase products.

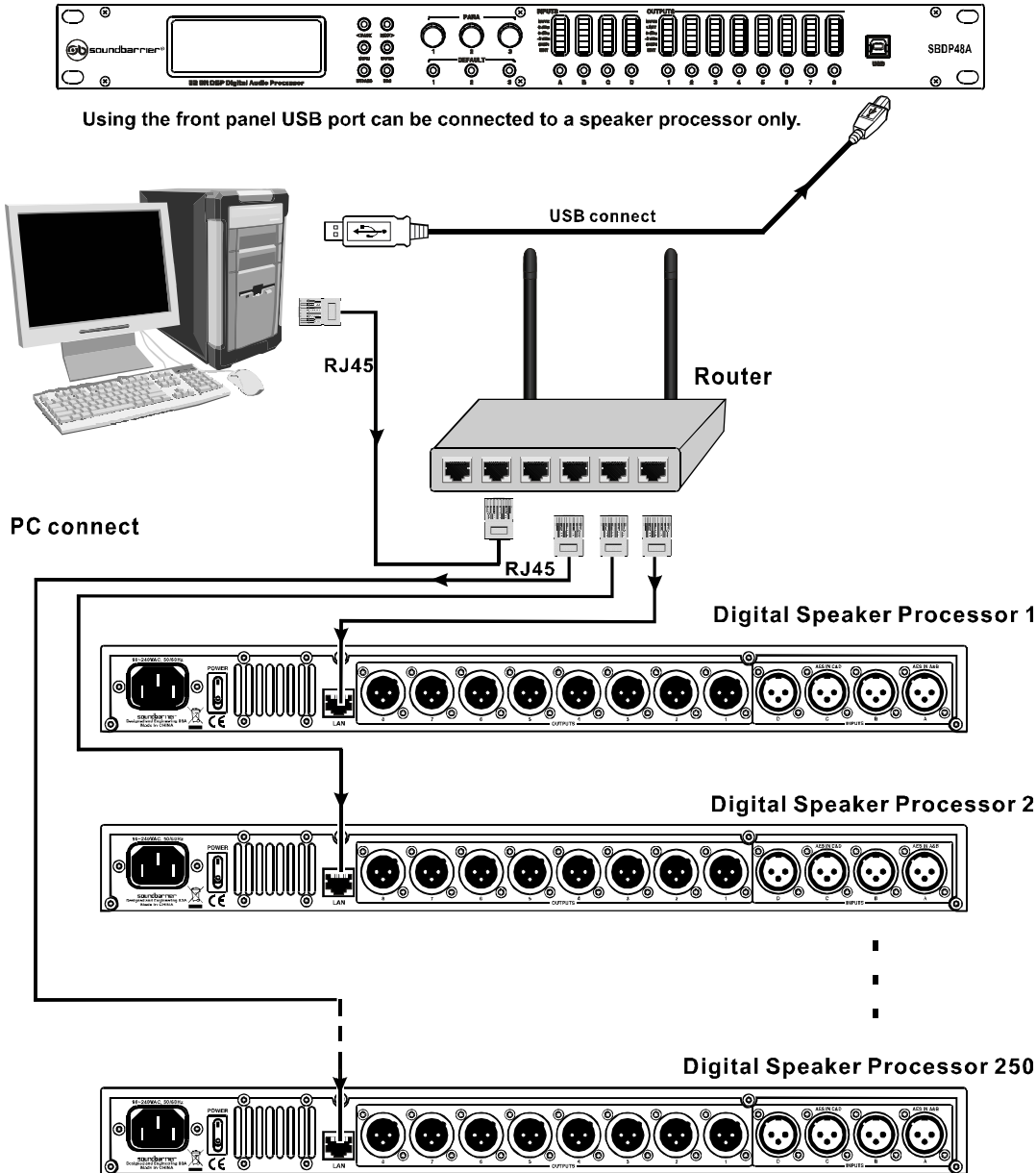

Use the back panel LAN connector can connect 250 set digital speaker processor.

(※ Each speaker processor connect to this systems should be set up different IP Address.)

PC Software Operation

Soft Vision:

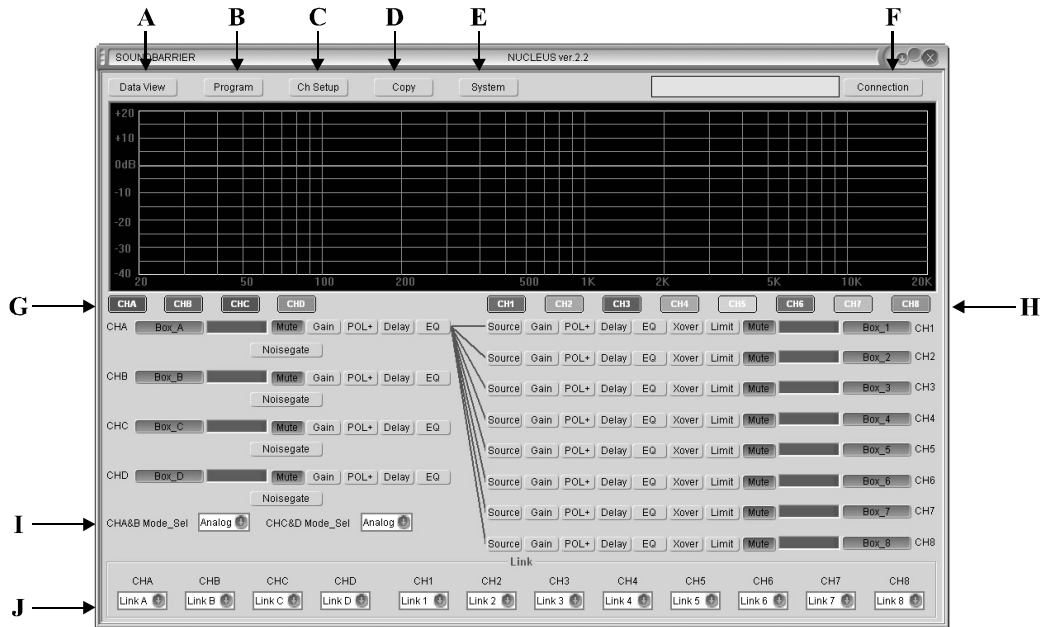

- | | |
|--|--------------------------------|
| A. Display Information Data | F. Connect Option |
| B. Save or Load the Program Interface | G. Input Channel |
| C. Change the Channel Name | H. Output Channel |
| D. Copy Edit | I. Input Source Setting |
| E. Change the System Setting | J. Channel Connect |

Connection: (Please confirm to use the connection line connect the computer and product. First connection need to install the driver, please use the attached CD)

Connection Connect state selection, after selected, display as below:

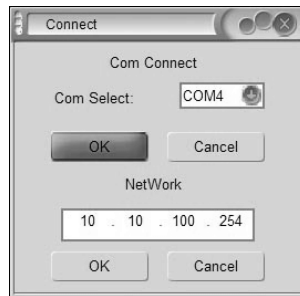

← Communication Port Select

← Network Address Setting

Com Select: Select workable computer

Click confirm connect to computer by USB data line

NetWork Select workable IP address

Click confirm connect to computer by wifi

PC Software Operation

Program Click into below page

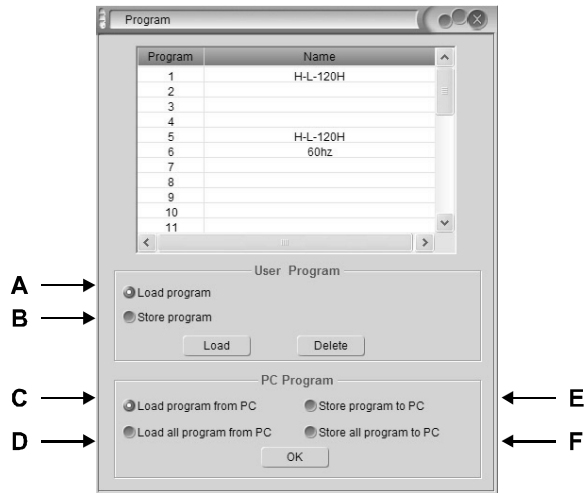

- A. Load/Delete a group user data or effect data from the connected device.
- B. Store/Delete a group user data or effect data to the connected device.
- C. Read out a group user data or effect data from the computer.
- D. Recall all group user data or effect data from the computer.
- E. Store a group user data or effect data to the computer.
- F. Store all group user data or effect data to the computer.

When delete one program:

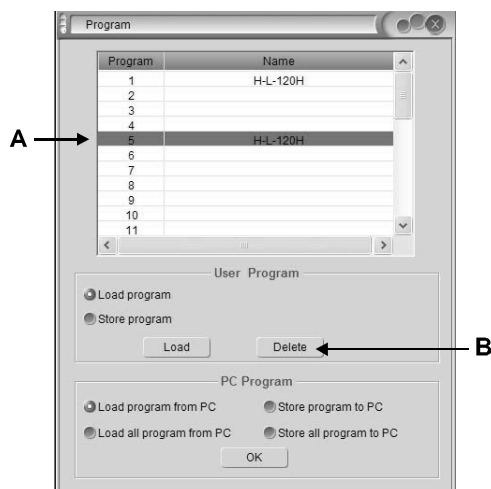

- A. Select one program.
- B. Click **Delete** Delete the selected program.

PC Software Operation

Ch Setup Click into below page

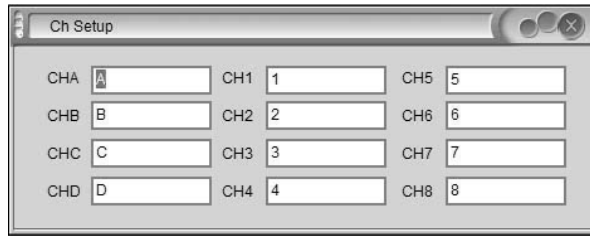

Can change the channel name directly

Copy Channel Copy Mode selecting, Click into below page



Can set same parameter for two channels directly.

System System Option, Click into below page

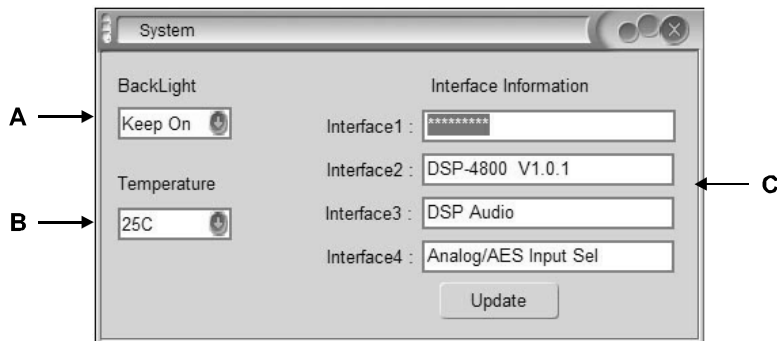

A: Change the LCD backlight display time

B: Change Temperature

C: The details of this product will be shown on the LCD (It can be amended)

Common Setting as below:

On Mute off, channel normal use. **Mute** Mute on, channel in mute.

CHA Channel in grey colour means the channel doesn't be selected.

CHA Click channel can switch the selection state, selected channel display relevant colour.

PC Software Operation

Signal edit vision at input state:

Each input channel setting is the same

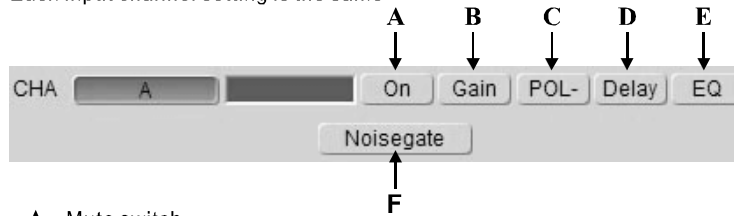

- A. Mute switch
- B. Adjust input gain
- C. Input phase setting
- D. Input delay setting
- E. Input parameter EQ setting (can drag the EQ number to adjust the relevant parameter)
- F. Noisegate setting

Signal edit vision at output state:

Each output channel setting is the same

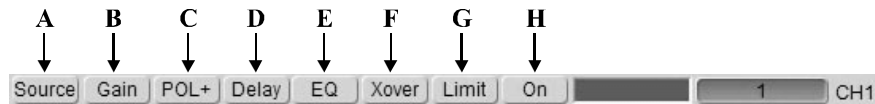

- A. Select output source
- B. Adjust output gain
- C. Output phase setting
- D. Output delay setting
- E. Output parameter EQ setting (can drag the EQ number to adjust the relevant parameter)
- F. Crossover setting (can drag the Crossover icon (H/L) to adjust the relevant parameter)
- G. Limiter setting
- H. Mute switch

Curve display vision:

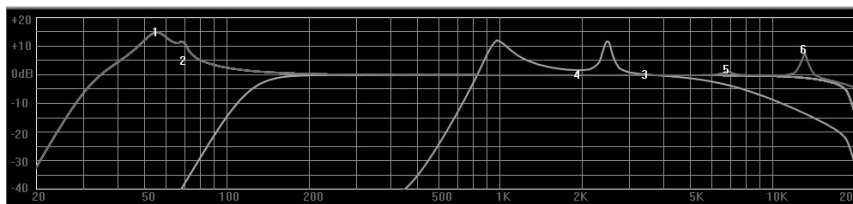

※ Drag the EQ icon(1\2\3\4\5\6)by mouse to adjust the relevant parameter.

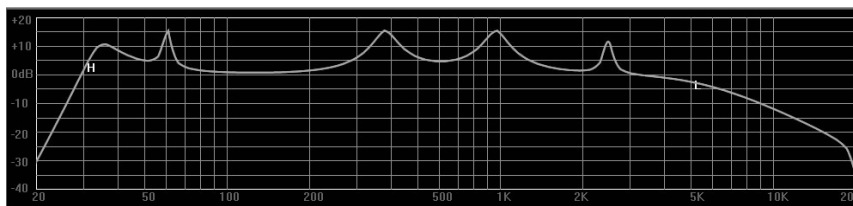

※ Drag the crossover icon(HL)by mouse to adjust the relevant parameter.

Single Processor Connection(Wired)

Processor ←→ Computer

1. Restore wifi module a Factory Setting in the Processor's front-panel

- ① Star-up the processor
- ② After the screen show out the model and brand of the processor, press the "MENU" key
- ③ Twist to "System SubMenu" with the knob , press the "Enter" key
- ④ Twist to "wifi Factory Reset" with the knob , press the "Enter" key
- ⑤ Twist to "YES" with the knob , press the "Enter" key
- ⑥ The screen will show "Successfully" , Success!

2. Set to gain the IP automatically with the network card.

- ① Click on the local connection icon on tabletop at the bottom right Corner,then click "Properties"

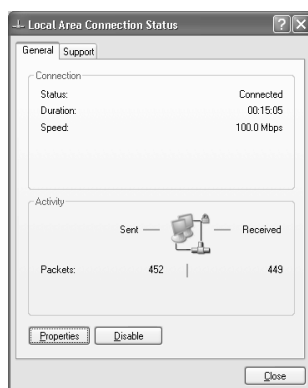

- ② Click the "Internet Protocol (TCP/IP) ",then click"Properties"again

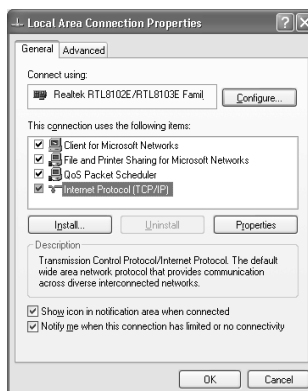

- ③ Click "Obtain an IP address automatically", OK

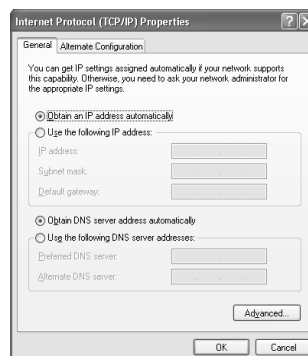

Single Processor Connection(Wired)

3. Connect the computer and processor with net line. The obtained IP address should be "10.10.100.100".

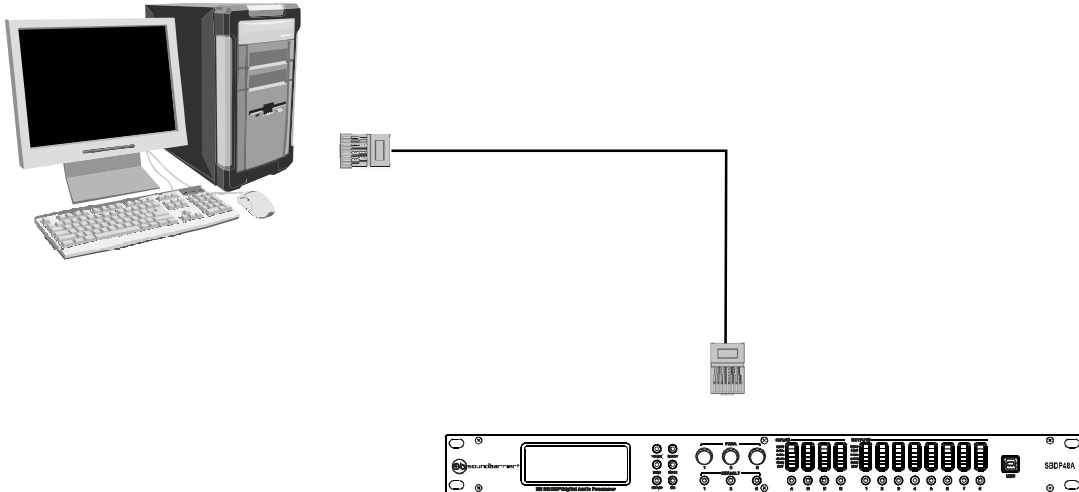

4. Open up the software interface, click on the top right corner "Connection".

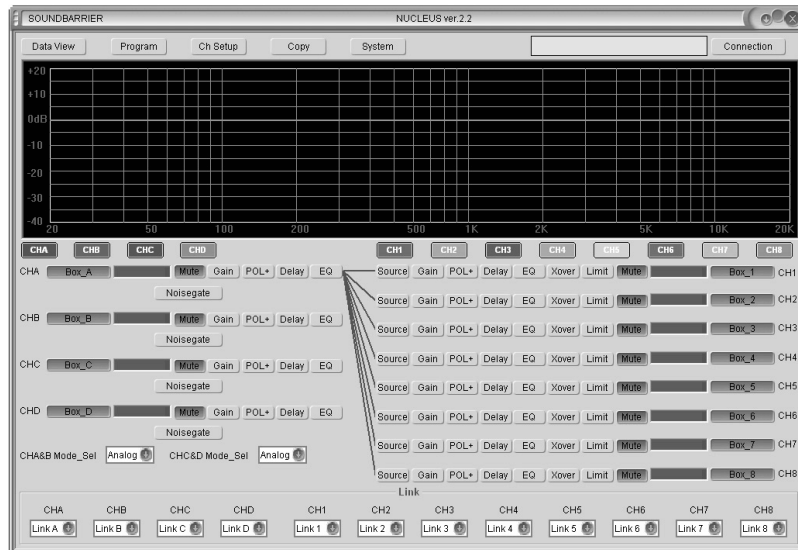

5. Input the IP address "10.10.100.254". Connection Success!

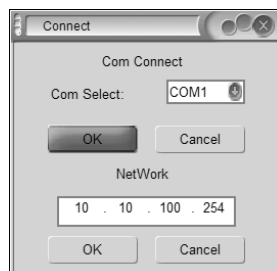

Many Processors Connection(Wired)

Processor ↔ Router ↔ Computer

1. Restore wifi module a Factory Setting in the Processor's front-panel

① Star-up the processor

② After the screen show out the model and brand of the processor, press the "MENU" key

③ Twist to "System SubMenu" with the knob , press the "Enter" key

④ Twist to "wifi Factory Reset" with the knob , press the "Enter" key

⑤ Twist to "YES" with the knob , press the "Enter" key

⑥ The screen will show "Successfully" , Success!

2. Set to gain the IP automatically with the network card.

① Click on the local connection icon on tabletop at the bottom right Corner,then click "Properties"

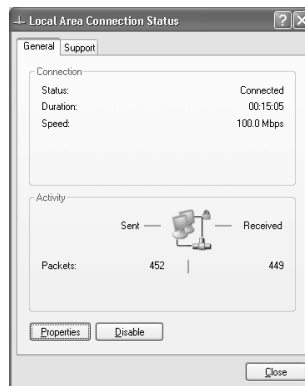

② Click the "Internet Protocol (TCP/IP) ",then click"Properties"again

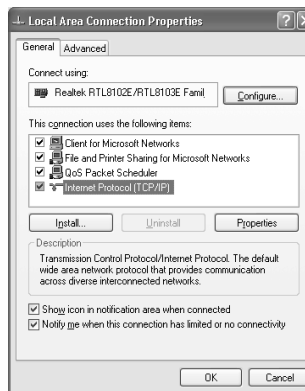

③ Click "Obtain an IP address automatically", OK

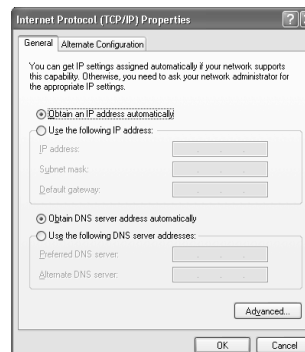

Many Processors Connection(Wired)

3. Connect the computer and processor with net line. The obtained IP address should be "10.10.100.100".

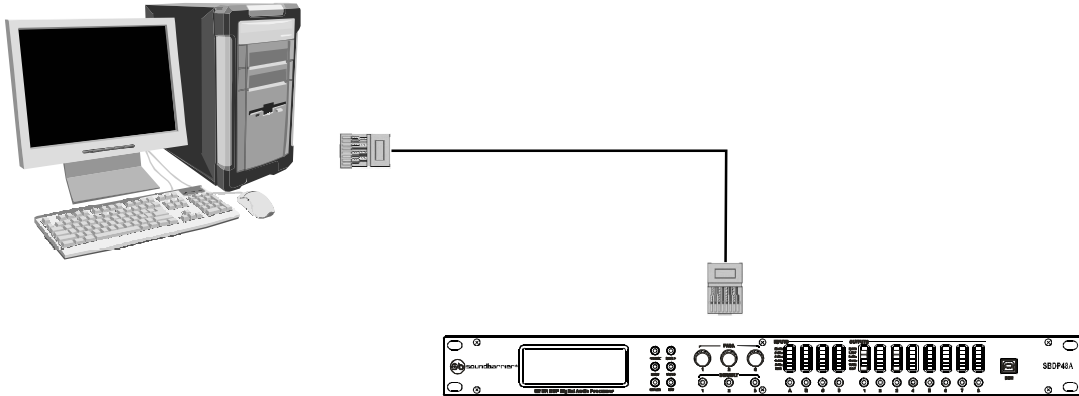

4. After connect the network successfully, type "10.10.100.254" on the IE browser, land to the wifi module. Input the user name: admin, password: admin, OK.



- ① Then enter "Working Mode Configuration" interface.

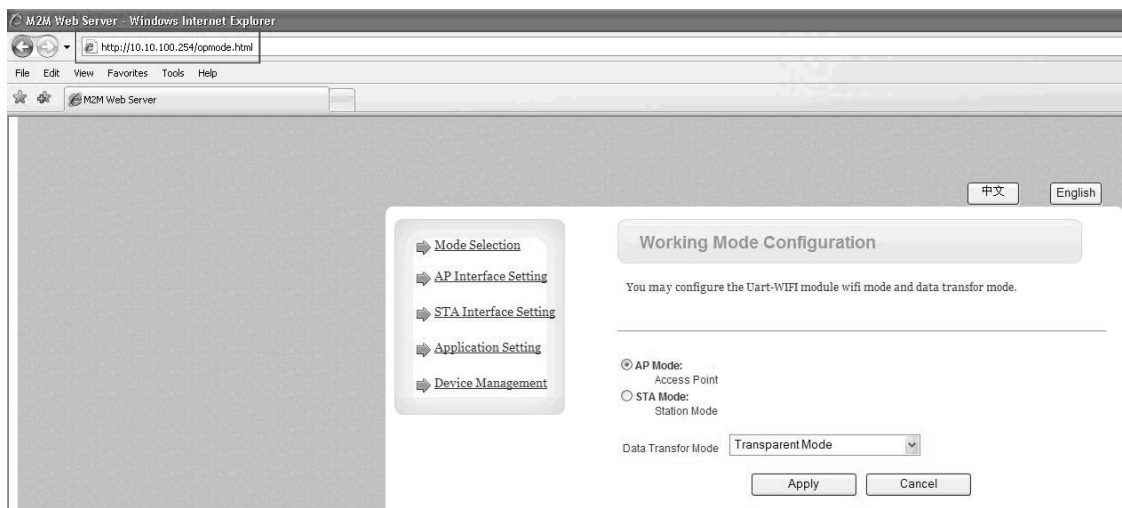

Many Processors Connection(Wired)

② Click on the top left corner "AP Interface Setting", input the "Network Name (SSID)": AB-Link.

③ Setting in underlying "LAN Setup".First step: made the "DHCP Type"into "Disable"; Second step: made the IP address of wifi module as the same as the Router"192.168.0.101"("192.168.0.102", "192.168.0.103"by the same token), Apply.

④ Click on the top left corner"Mode Selection",Set for the "Station Mode"(terminal mold STA), Apply .

Many Processors Connection(Wired)

- Restart the Processors. Computer connected Router, Router connected Processors (here with two net lines or more).

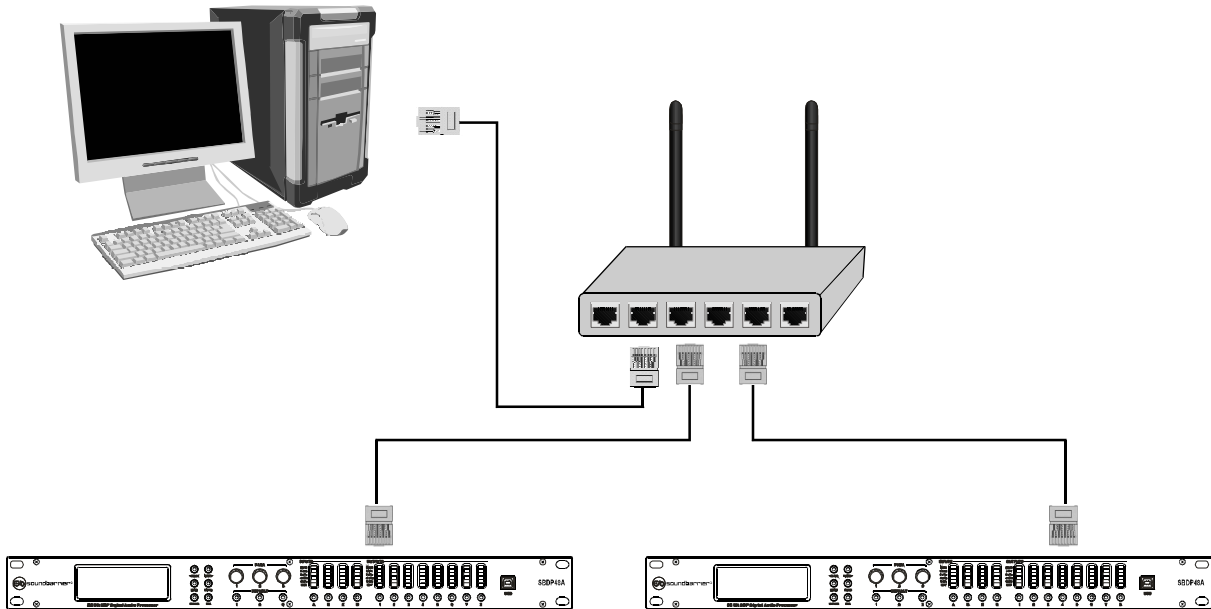

- Open up the software interface, click on the top right corner "Connection".

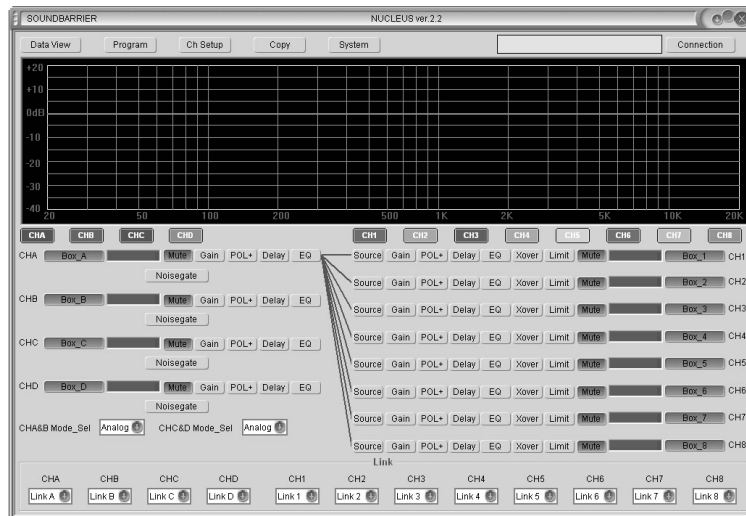

Many Processors Connection(Wired)

7. Type the IP address "192.168.0.101", "192.168.0.102", "192.168.0.103".....
(This IP address should be the same with the DHCP IP address).Connection Success !

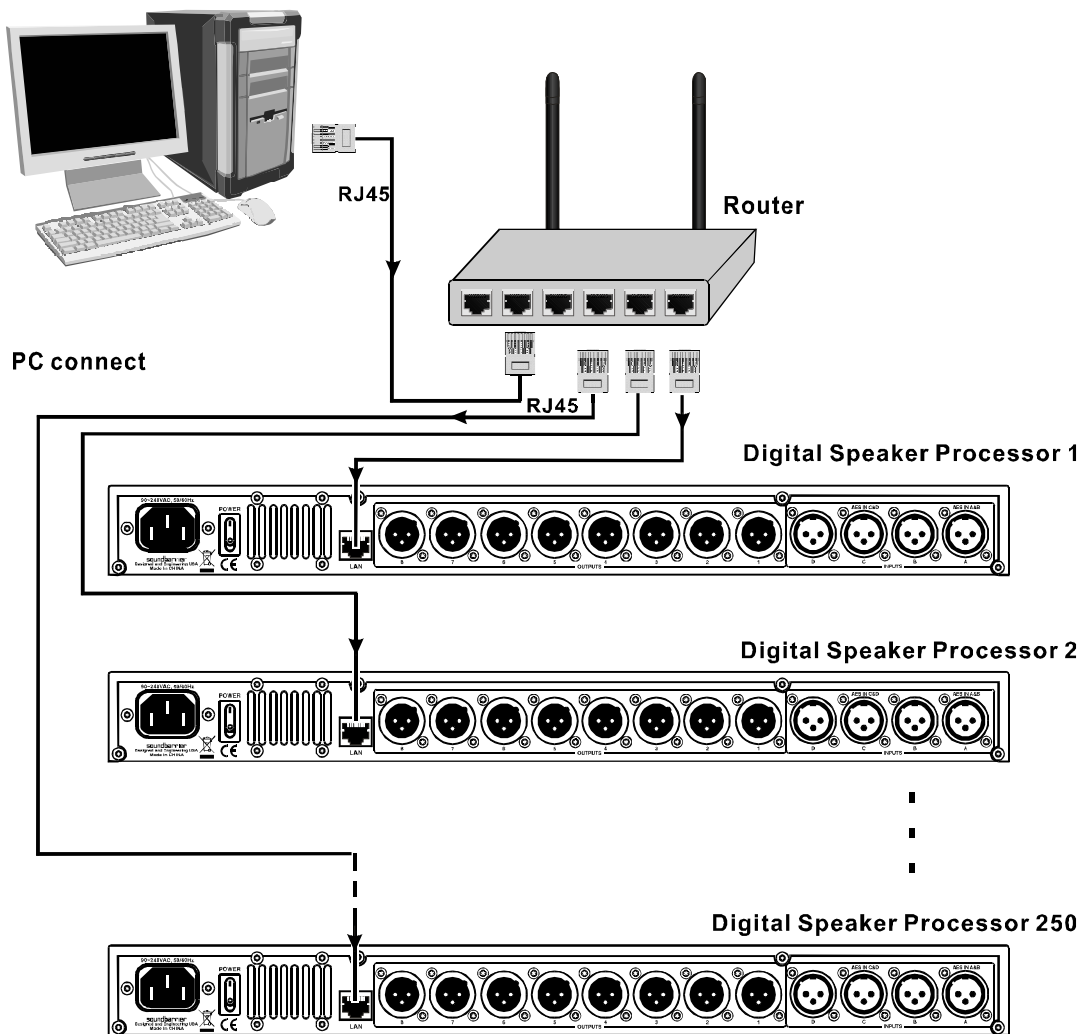
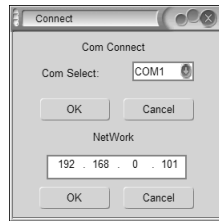

Use the back panel LAN connector can connect 250 set digital speaker processor.

(※ Each speaker processor connect to this systems should be set up different IP Address.)

soundbarrier®

Soundbarrier is constantly striving to maintain the highest quality and standards. As a result of these efforts, modifications may be made to this product without notice.

Soundbarrier esta constantemente buscando el mas alto nivel de calidad y ejecución, por dicho esfuerzo, podriamos modificar las especificaciones sin previo aviso.

Soundbarrier, USA

for more information visit / para mas información visite: www.soundbarrier.com