



GAC MARINE SOLUTIONS



GOVERNORS AMERICA CORP.

1+413-233-1888

<https://www.governors-america.com>

GOVERNORS AMERICA CORP. (GAC) MARINE SOLUTIONS	3
MARINE CERTIFICATIONS.....	3
BAUDOIN 6X	4
TUG BOAT.....	4
CATERPILLAR 3408	5
FISHING BOAT GOVERNOR REPLACEMENT.....	5
CATERPILLAR 3516 69L	6
TUGBOAT PROPULSION.....	6
CUMMINS KT38	7
ALASKAN TUG BOAT.....	7
CUMMINS QSM11	8
DEEP WATER VESSEL.....	8
DEUTZ 12L513, V-12, 19.14 L	9
ALASKA RUNNER GENERATORS.....	9
DEUTZ 1013/1012 & VOLVO 520/720	10
INDUSTRIAL / GEN SET.....	10
MAN 9L20	11
INDUSTRIAL / GEN SET.....	11
MHI S12A2, S12R, and S16R (Volvo Penta D34 , D49, D65)	12
MITSUBISHI HEAVY IND and VOLVO PENTA.....	12
MTU 183 150 kW	13
MARINE PROPULSION – GENERATOR DRIVE.....	13
PERKINS N844	14
PUMA OCEAN RACING.....	14
VOLVO D30	15
MARINE PROPULSION / GENERATOR DRIVE.....	15
VOLVO TD/TWD	16
INDUSTRIAL and MARINE GEN SET.....	16
VOLVO 520/720 / DEUTZ 1013/1012	17
MARINE GEN SET.....	17
YANMAR 500 HP 6CXBM	18
MARINE GEN SET.....	18

GOVERNORS AMERICA CORP. (GAC) MARINE SOLUTIONS

GAC takes pride that our products are Bureau Veritas, RINA, and Lloyd's Register certified for steel ships. The rugged designs and high-quality components of our speed controllers and actuators allows them to endure the harshest environmental conditions. Some certified products include the ESD5100, ESD5300, and ESD5500 series governors and the 120, 175, 176, 225, 275, and 2001 series actuators.

MARINE CERTIFICATIONS

Copies of certifications can be found on the [Governors America Corp website](#).



Bureau Veritas

Actuator 120, 175, 176, 180, 200x, 225 and 275 Series
Speed controllers ESD5100, ESD5200, ESD5300, ESD5500 series
Magnetic Speed Pick-ups MSP67X and MSP67XX series



RINA

Speed controller ESD 5500E Series
Actuator 180 Series



Lloyds Register

Actuators 120, 175, 176, 180, 200x, 225 and 275 Series
Speed controllers ESD5100, ESD5200, ESD5300, ESD5500 series
Magnetic Speed Pick-ups MSP67X and MSP67XX series

BAUDOUIIN 6X

TUG BOAT

For Baudouin Marine Engines, this GAC solution replaced flanged mechanical governor with electronic governor using ACE275 actuator on the In-line injection P Pump to provide consistent engine speed. The ESD5500E tunes that speed just right.



ESD5500E



275 SERIES ACTUATOR



NOTE: All components are sold separately.

COMPONENT	PART NUMBER	DESCRIPTION
Speed Controller	ESD5500E	Multi-V DC, droop control, Adjustable PID, Speed ramping, Soft coupling
Actuator	ACE275H	24 V DC with Packard connector without mating connector. Stop lever included

CATERPILLAR 3408

FISHING BOAT GOVERNOR REPLACEMENT

A fishing vessel needed a cost-effective replacement to their aging Woodward PSG. The purchase price and installation was expensive and time consuming. Instead, they chose GACs external mount ADB225 and the ESD2244-24 saving both downtime and money.



ESD2244-241



225 SERIES ACTUATOR



NOTE: All components are sold separately.

COMPONENT	PART NUMBER	DESCRIPTION
Actuator	ADB225	24 V DC • Light-Force (Low-Current Optimized PID), Isochronous operation, Precise speed control, Adjustable PID functions, 8:1 speed range control, Light-force option available
Speed Controller	ESD2244	24 V DC • Light-Force (Low-Current Optimized PID), Isochronous operation, Precise speed control, Adjustable PID functions, 8:1 speed range control, Light-force option available

CATERPILLAR 3516 69L

TUGBOAT PROPULSION

A tugboat in Iceland needed to replace the main propulsion control system for its 2 Caterpillar 3516, 69L V16 engines. The output of both engines needed to be balanced, connected to a single drive train, and controlled with a single potentiometer. The solution was to install two GAC ACB2001 actuators and two ESD5330 controllers connected with a harness designed for the application with built in potentiometers to adjust and balance the engines individually and a single potentiometer to control the speed of both engines at once.



All sea trials were successfully completed after the GAC Control system was installed. The tugboat returned to service, continuing to perform without incident. The Captain reported the fastest cruising speed ever.



ESD5330



2 – ACB2001



2 – Wiring Diagram

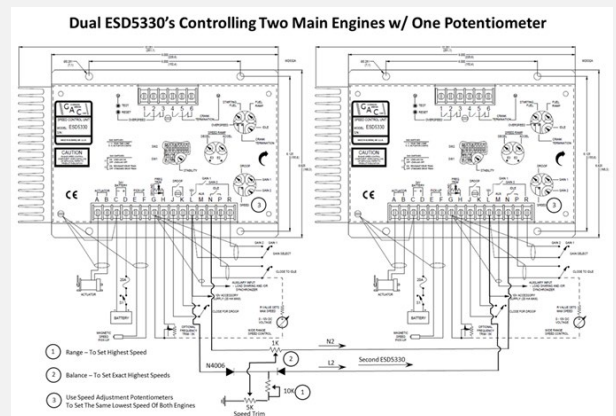

NOTE: All components sold separately.

COMPONENT	PART NUMBER	DESCRIPTION
Actuator	ACB2001	24 V DC, Heavy duty, w/ lever, Terminal strip, Rapid response to transient conditions, Multiple mounting positions, Uni-directional CW/CCW, Internal return spring
Speed Controller	ESD5330	24 V DC, Two-element speed switch,

CUMMINS KT38

ALASKAN TUG BOAT

The *GLACIER WIND* of COOK INLET, AK needed more stable control of its 2 Cummins KT38 Engines: V12, 38L (2300 in3) Turbocharged / After-cooled engines. GAC had the answer with ramping control and a heavy-duty actuator.



ESD5221

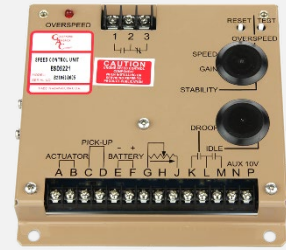

RSC671

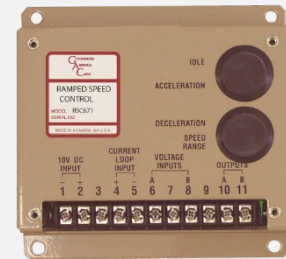

ADB120E4

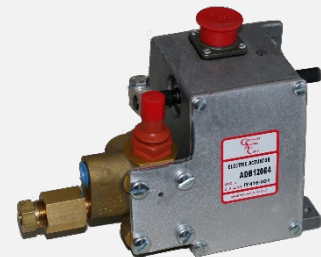

NOTE: All components are sold separately.

COMPONENT	PART NUMBER	DESCRIPTION
Speed Controllers	ESD5221	2 Multi-V DC, Overspeed Switch, Overspeed LED, Selectable droop
Actuator	ADB120E4	2 actuators designed specifically for Cummins PT fuel system
Other Items	RSC671	2 Speed Ramping Controllers

CUMMINS QSM11

DEEP WATER VESSEL

Ease of use , reliability, and system compatibility are hallmarks of GAC equipment



A deep-water operations vessel had a question about a new piece of GAC equipment, the LSM201N load sharing module, recently added to a pair of auxiliary generators - QSM11 Cummins engines with the ISM Engine Control Module (ECM). Balancing power distribution between engines is the primary function of the LSM. It can also provide power control through ramping and monitoring, accurately measuring true engine power.

When one of the two QSM11-DM engines reversed power it was easy to determine the cause. Out of the box the LSM201N interpreted the ECM increased voltage to be a request to decrease power. But the ECM translated increased voltage as a need to increase power. The LSM was built to allow a hardware solution of adding a jumper to change polarity, but like both GACs EEG7000 and the EEG7500 controllers, the ECM was also able to use software to match the LSMs polarity. The issue was easily resolved and the boat was quickly back in service.

CUMMINS QSM11



LSM201N

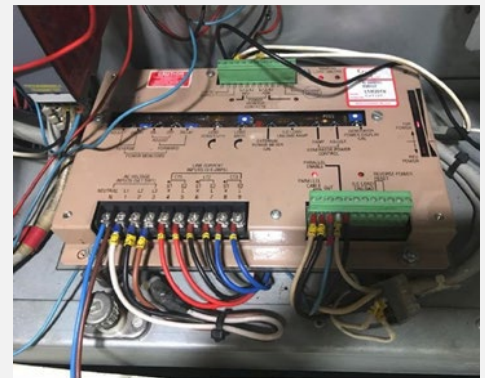

NOTE: All components sold separately.

COMPONENT	PART NUMBER	DESCRIPTION
Speed Controllers	LSM201N	2 Multi-V DC, Overspeed Switch, Overspeed LED, Selectable droop

DEUTZ 12L513, V-12, 19.14 L

ALASKA RUNNER GENERATORS

The Alaskan AP188 Hovercraft uses two RCS671 controllers in conjunction with two ESD5221 controllers driving two ACE275 actuators installed on the main propulsion engines, Deutz 12L513's, powering two 9-foot propellers.



ESD5221

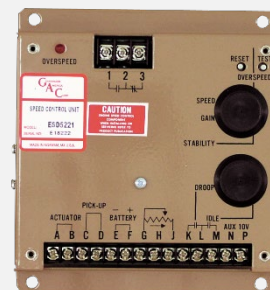

RSC671



ACE275



NOTE: All components sold separately.

COMPONENT	PART NUMBER	DESCRIPTION
Speed Controllers	ESD5221	2 Multi-V DC, Overspeed Switch, Overspeed LED, Selectable droop
Actuator	ACE275H	2 24 V DC Packard connector without mating connector, Stop lever included
Other Items	RSC671	2 Speed Ramping Controllers

DEUTZ 1013/1012 & VOLVO 520/720

INDUSTRIAL / GEN SET

The 180 Series Integral Actuator mounts directly to Deutz 1013/2012 and Volvo 520/720 engines. The existing mechanical governor is removed from the engine and the 180 Series Integral Actuator is mounted in its place.

The 180 Series Actuator provides proportional movement based on actuator coil current. This unique, optimized, fuel control outperforms externally mounted electric actuators. No external linkage or brackets are required. Paired with high-performance speed controller provides optimized fuel control which outperforms externally mounted electric actuators.



ADD180G



ESD5500E



IN THE SHOP

DEUTZ

- 1012, 1013 and 2012

VOLVO

- TD 420 4.76L 4 Cy, 7.15L 6-Cyl
- TAD 420, TAD 520, TAD 531, TAD 720 and TAD 731
 - D5A and D7A

NOTE: All components sold separately.

COMPONENT	PART NUMBER	DESCRIPTION
Actuator	ADD180G	Designed to mount directly to Deutz 1013/2012 and Volvo 520/720, includes mounting kit
Speed Controller	ESD5500E , ESD5111 , ESD5500-II , ESD5550	Isochronous, Variable Speed, Droop Governors

MAN 9L20

INDUSTRIAL / GEN SET

The ARA PUERTO DESEADO oceanographic research vessel needed an overhaul before it returned to work studying the continental shelf as far south as Antarctica.

Powered by 2 MAN 9L20 / 27 900 KW diesel engines and 2 ABB 380V, 120 kW AC electric motors for auxiliary propulsion the EEG6500 was used to update speed control of its power plant, replacing the original system



ESD6500



NOTE: All components sold separately.

COMPONENT	PART NUMBER	DESCRIPTION
Speed Controller	<u>EEG6500</u>	Isochronous, Variable Speed, Droop Governor

MHI S12A2, S12R, and S16R (Volvo Penta D34 , D49, D65)

MITSUBISHI HEAVY IND and VOLVO PENTA

The ESD5340 Speed Controller offers superior full fuel control from rated operating speed to low idle due to its unique combination of features like dual gain adjustment, one for idle and one for operating speed, with independently adjustable acceleration and deceleration speed ramping controls. The actuator is mounted on stiff rubber elements and connected to the original linkage.

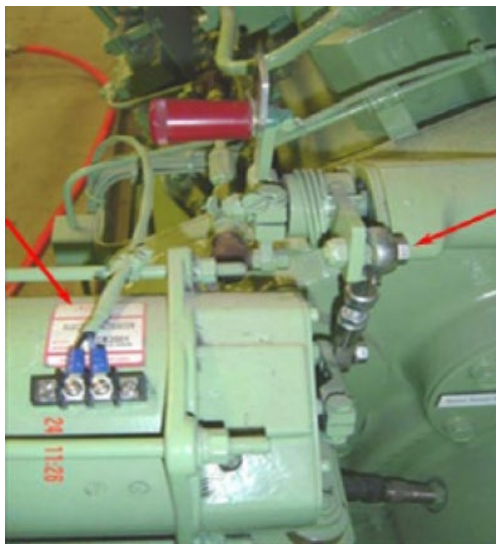

ESD5340



ACB2001



IN THE SHOP

MHI S16R-PTA; 3989 CU IN / 65.37L V16



NOTE: All components sold separately.

COMPONENT	PART NUMBER	DESCRIPTION
Actuator	ACB2001	24 V DC, Heavy duty actuator with lever, Terminal strip, Rapid response to transient conditions, Multiple mounting positions, Uni-directional CW/CCW, Internal return spring
Speed Controller	ESD5340	24 V DC, Two-element speed switch, Speed ramping, Starting fuel control, Unique actuator power drive circuit, dynamic start

MTU 183 150 kW

MARINE PROPULSION – GENERATOR DRIVE

This private yacht uses the EGS104B speed controller to control the actuators and synchronizers on each of the 2 MTU 183 generators, 150 kW, diesel engines to share information and provide smooth transitioning.

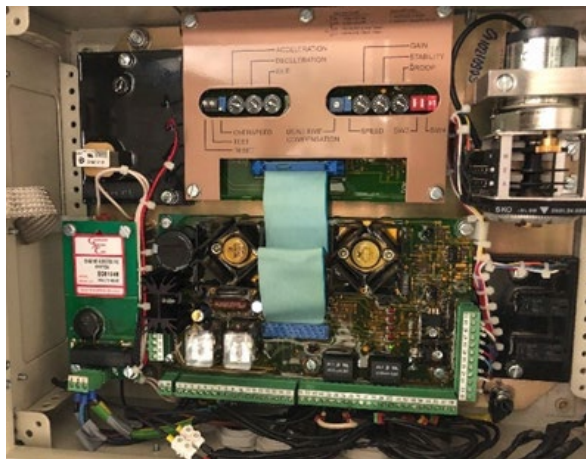

EGS104



LSM201



SYC6714

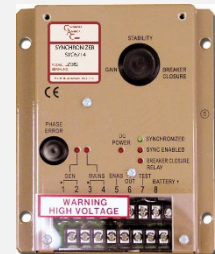

ACE275



NOTE: All components sold separately.

COMPONENT	PART NUMBER	DESCRIPTION
Controllers	EGS104	Stabilizer
	LSM201	Load share modules
	SYC6714	Automatic Synchronizer with Sync Check Relay
Actuator	ACE275	24 V DC, Heavy Duty bearing retention, Position feedback sensor, includes stop lever, Optimum performance for in-line pumps

PERKINS N844

PUMA OCEAN RACING

The Puma Ocean Racing Team installed a Perkins N844 four cylinder engine to adjust the keel on one of their sailboats. GACs ALR160-S04 actuator and SDG725 Smart Digital Governor supports the application which required a fast, compact, flexible variable speed system that can be controlled from above or below deck. The ALR160 actuator replaced the shut off solenoid in the PF pump housing, acting directly on the fuel control rack. Sea trials found this control system exceeded all expectations, sending the customer off to the races.



SDG725 SMART DIGITAL GOVERNOR



ALR160-S04



IN THE SHOP

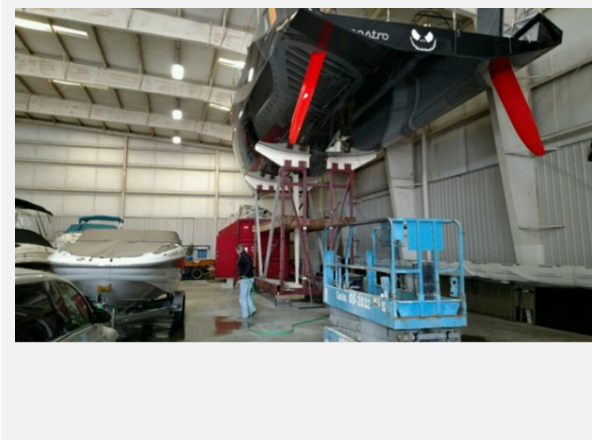

NOTE: All components sold separately.

COMPONENT	PART NUMBER	DESCRIPTION
Speed Controller	SDG725	Compact digital engine speed governor
Actuator	ALR160-S04	Linear Actuator Shibaura (Perkins) N843-C, N844L-C, N844LT-C, Caterpillar C-series, Volvo D2

VOLVO D30

MARINE PROPULSION / GENERATOR DRIVE

The MHI S6R2 engine series fit with a GAC electronic governor systems for superior speed control serves in gen-sets and marine propulsion applications. The VOLVO D30 (MHI S6R2) engine with GAC speed controller and actuator on PS6-48 270 pump



ESD5500E



ADC225S-24



IN THE SHOP

Mitsubishi S6R2, 24.5L In-Line 6 Cylinder Power Ratings Range from 480 to 759 kW at 1500 RPM, Diesel

Operating Speed(s): 1500 / 1800 RPM and Variable Speed

NOTE: All components sold separately.

COMPONENT	PART NUMBER	DESCRIPTION
Speed Controller	ESD5500E	Multi- V DC controller (Volvo Part Number 3817999)
Actuator	ADC225S-24	Rotary output, linear torque, proportional servo (Volvo Part Number 3838271)
Other Items	MSP6827C	Magnetic Speed Pickup

VOLVO TD/TWD

INDUSTRIAL and MARINE GEN SET

This industrial engine retrofit includes a GAC speed controller and actuator.

COMPLETED INSTALLATION

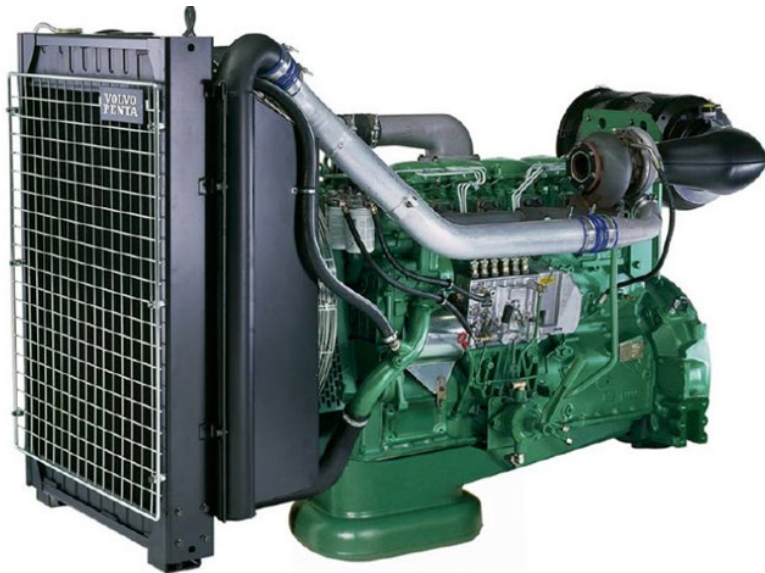

VOLVO TAD1032 ENGINE: 397 HP AT 1500 RPM / 390 HP AT 1800 RPM

ESD5500E



ACD175A-24



IN THE SHOP

Supports the following engines:

- TD/TWD610-5.5L 6 Cylinder
- TD/TWD710- 6.7L 6 Cylinder
- TAD721, 730 and 740-7.3L 6 Cylinder
- TD1010, 1030, 1031 and 1032-9.6L 6 Cylinder

Diesel, MW Pump, Bosch P3000 and P7000 Inline Pumps

NOTE: All components sold separately.

COMPONENT	PART NUMBER	DESCRIPTION
Speed Controller	ESD5500E	Multi- V DC controller (Volvo Part Number 3817999)
Actuator	ACD175A-24 or ACB275H-24	24 V DC, Packard, Double rack bearing • BYC ASIMCO KT283 included
Other Items	MSP6728C KT275 or KT276	Magnetic Speed Pickup Mounting Kit

VOLVO 520/720 / DEUTZ 1013/1012

MARINE GEN SET

Limmat Marine Controls uses the ESD5500E speed controller combined with the RSC671 provides precise acceleration / deceleration control through the ADB225 actuator.

The SSW675 provides crank / overspeed switching on the 12-cylinder Deutz 1013 with a mechanical governor and inline pump.



COMPLETED INSTALLATION

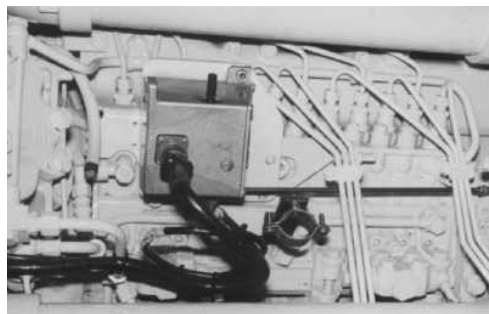

ADB225



ESD5500E



RSC671

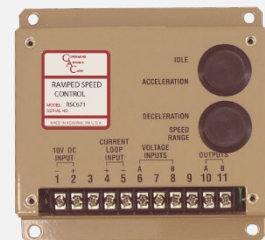

SSW675



NOTE: All components sold separately.

COMPONENT	PART NUMBER	DESCRIPTION
Speed Controller	ESD5500E	Multi- V DC controller
Actuator	ADB225	Electric actuator, rotary-output, linear-torque, proportional servo
Other	RSC671 SSW675	Ramp speed control Speed Switch, overspeed

YANMAR 500 HP 6CXBM

MARINE GEN SET

This NZ Coast Guard vessel needed reliable throttle control with high torque during tight maneuvers. Improved torque was the answer. Bluff Coast Guard/Rescue Vessel "Bluff Rescue"



On the Boat:

- 2 - 500 HP Yanmar 6CXBM Diesel Engines with Fuel Injection Pump
- Axiomatic controller
- Hamilton Blue Arrow Jet Controls

NOTE: All components sold separately.

ACB2001



COMPONENT	PART NUMBER	DESCRIPTION
Actuator	ACB2001	24 V DC, Heavy duty, Includes lever, Terminal strip, Rapid response to transient conditions, Multiple mounting positions, Uni-directional CW/CCW, Internal return spring



SOLUTIONS THAT OUTLIVE THE LIFE OF THE ENGINE

GAC OFFERS PROVEN RESULTS

GAC's advanced gaseous-fueled engine management system with exhaust emissions control technologies meet the tough standards sanctioned in the United States and the rest of the world. The total system approach results in a cost-effective solution that offers the greatest potential for improvements in both engine efficiency and exhaust emissions while providing many features.

Governors America Corp. (GAC) is a leading provider of innovative engine control products worldwide. As a veteran-owned and operated family business, our dedication and focus on our customers' needs has shaped GAC into a vertically integrated company with complete design, development and manufacturing capabilities.

Our mission is to provide trusted solutions for the innovative equipment that powers and builds our world. GAC's market-focused efforts provide precise electromechanical and electronic engine devices and speed control systems globally.