

SCREEN
INNOVATION & RELIABILITY

PlateRite 8600/8000II/8100

Thermal Plate Recorders

CTP



The versatility and performance you need for your pressroom

WHY IS THERMAL COMPUTER-TO-PLATE (CTP) TECHNOLOGY THE SYSTEM OF CHOICE FOR SO MANY SUCCESSFUL COMPANIES? THERE'S NO DOUBT ABOUT THERMAL CTP'S RELIABLE HIGH-QUALITY OUTPUT. IT IS UNRIVALLED FOR ITS SUPERB SHARP DOTS. WHENEVER QUALITY IS CRUCIAL, THE NATURAL CHOICE IS THERMAL. ITS CONSISTENCY FOR LONG RUN LENGTHS AND EASY DAYLIGHT HANDLING ARE ALSO IMPORTANT FOR MANY PRINTERS. AND THE BOTTOM LINE IS ALWAYS ABOUT KEEPING THE PRESSES RUNNING.

THE PLATERITE 8600, PLATERITE 8000II, AND PLATERITE 8100 ARE STATE-OF-THE-ART THERMAL CTP RECORDERS. THEY DELIVER THE VERSATILITY AND PRODUCTIVITY YOU NEED TO KEEP YOUR PRESSES RUNNING. AND THEY CAN DO THIS FOR ANY PLATE FORMAT FROM B3 TO B1 SIZE.

BOTH ALSO OFFER OPTIONAL INLINE PLATE PUNCHING FOR PERFECT ON-PRESS REGISTER AND FASTER MAKEREADY TIMES, AS WELL AS SCREEN'S ACCLAIMED AUTOLOADER OPTIONS FOR UNATTENDED PLATE LOADING. IF YOU LIKE THE IDEA OF RUNNING YOUR PRESSROOM AT FULL CAPACITY, YOU'LL LOVE THE PLATERITE 8600, PLATERITE 8000II, AND PLATERITE 8100.



Advanced Technology

Versatility and productivity

Fast, reliable thermal CTP output

Thermal plates are well known for their consistency and quality. And with the thermal PlateRite series, you can output them fast. When imaging 1030 x 800 mm (40.6" x 31.5") plates at 2400 dpi, the PlateRite 8000II can output 13 plates per hour. Or, if you need extra speed, the PlateRite 8600 will comfortably run at 20 plates per hour. The more economical PlateRite 8100 outputs a respectable 8 plates per hour. All three platesetters are supported by Screen's full range of automation options.

Model	PlateRite 8600	PlateRite 8000II	PlateRite 8100
Plates per hour	20	13	8
Imaging head	64 channels	32 channels	16 channels
Plate sizes	B3 to B1		

Run your pressroom at full capacity

There's no better way to use the full capacity of your pressroom than to achieve high plate output with reliable thermal plates. And the PlateRite 8600, PlateRite 8000II, and PlateRite8100 can do this even for pressrooms that use multiple plate sizes. Both models can output plates for most presses in the B3 to B1 range. The minimum plate size is 450 x 370 mm (17.7" x 14.5") and the maximum is 1,160 x 940 mm (45.6" x 37"). They can handle plates as thin as 0.15 mm (5.9 mil) and as thick as 0.3 mm (11.8 mil). If you need to output plates for multiple presses in this range, you owe it to yourself to look at the PlateRite 8600, PlateRite 8000II, and PlateRite 8100.

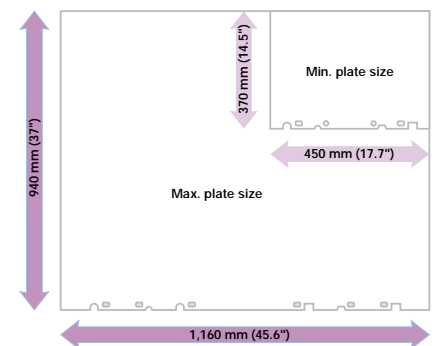

Advanced external drum design

The thermal PlateRite series is constructed with a reliable external drum design. This makes it possible for the drum to spin at high speeds with the imaging head positioned close to the surface of the plate. Easy maintenance of the imaging head is another key advantage of this design. Individual laser diodes can be replaced as required.

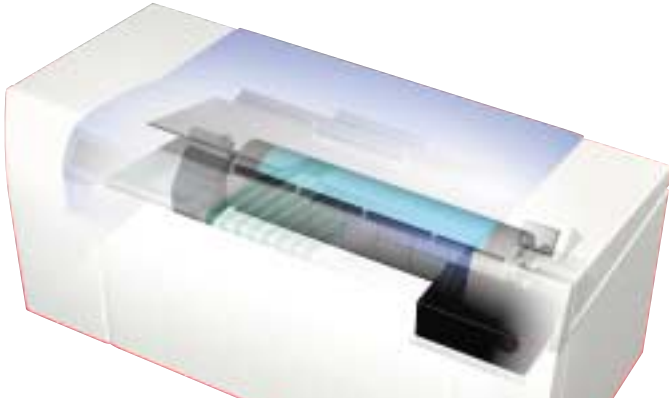

Intelligent auto-balance system

Thanks to this auto-balance system, no manual adjustments are required for drum balance when switching to a different sized plate. All you need to do is select the plate size from the display menu and the auto-balance system automatically optimizes the balance of the recording drum.

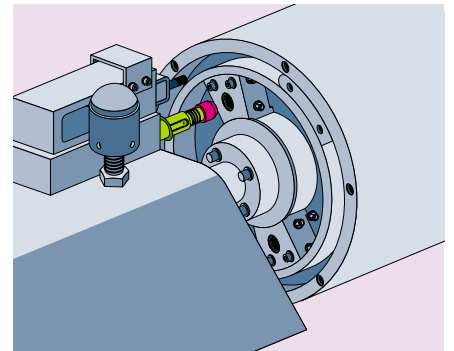

Automatic inline punching

Screen's automatic inline punching system is the industry leader for enabling perfect register on press. It does this by performing the two types of punching (for press and platesetter registrations) at the same time, immediately before mounting the plate on the drum. This method gives much greater accuracy compared with either manual or off-line punching. It also eliminates human error and achieves faster press makeready. Up to eight punch blocks can be mounted and selected according to plate size and press type.

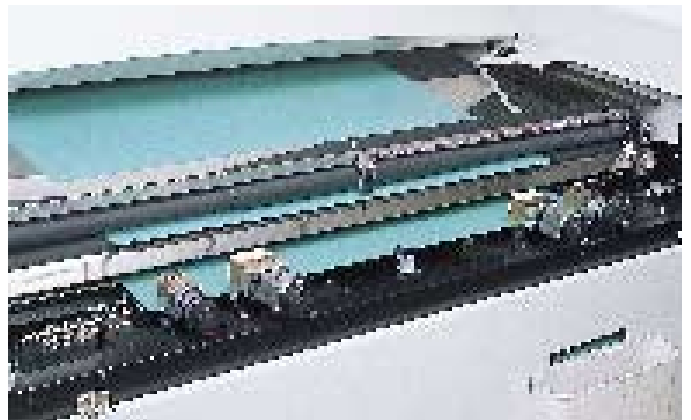

State-of-the-art plate-securing system

The PlateRite 8600, PlateRite 8000II, and PlateRite 8100 feature an automated clamping and vacuum system. This system can reliably and firmly secure a wide range of plate sizes, even for fast-rotation/high-speed exposure.

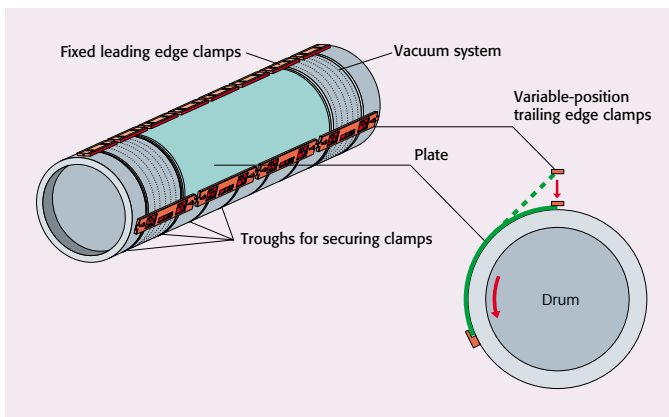

Compatible with 8-mm clamps

The PlateRite 8600, PlateRite 8000II, and PlateRite 8100 support the use of 8-mm clamps as well as common 12-mm clamps. Most web offset presses require smaller clamp sizes to ensure that the maximum imaging area is made available. By supporting 8-mm clamps the PlateRite 8600, PlateRite 8000II, and PlateRite 8100 are able to cover the requirements of both web and sheet-fed offset presses.

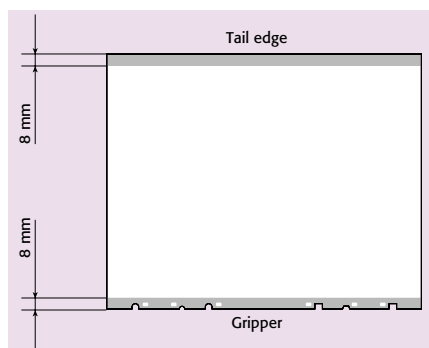

If automated plate production is part of your plan for CTP success, the PlateRite 8600/8000II/8100 has what you're looking for

Multi-cassette loading



1 The lifting unit moves to the same level as the cassette that holds the selected plate type.



2 The cassette is conveyed into the single-cassette autoloader.



3 The cassette is lifted to the loading position.

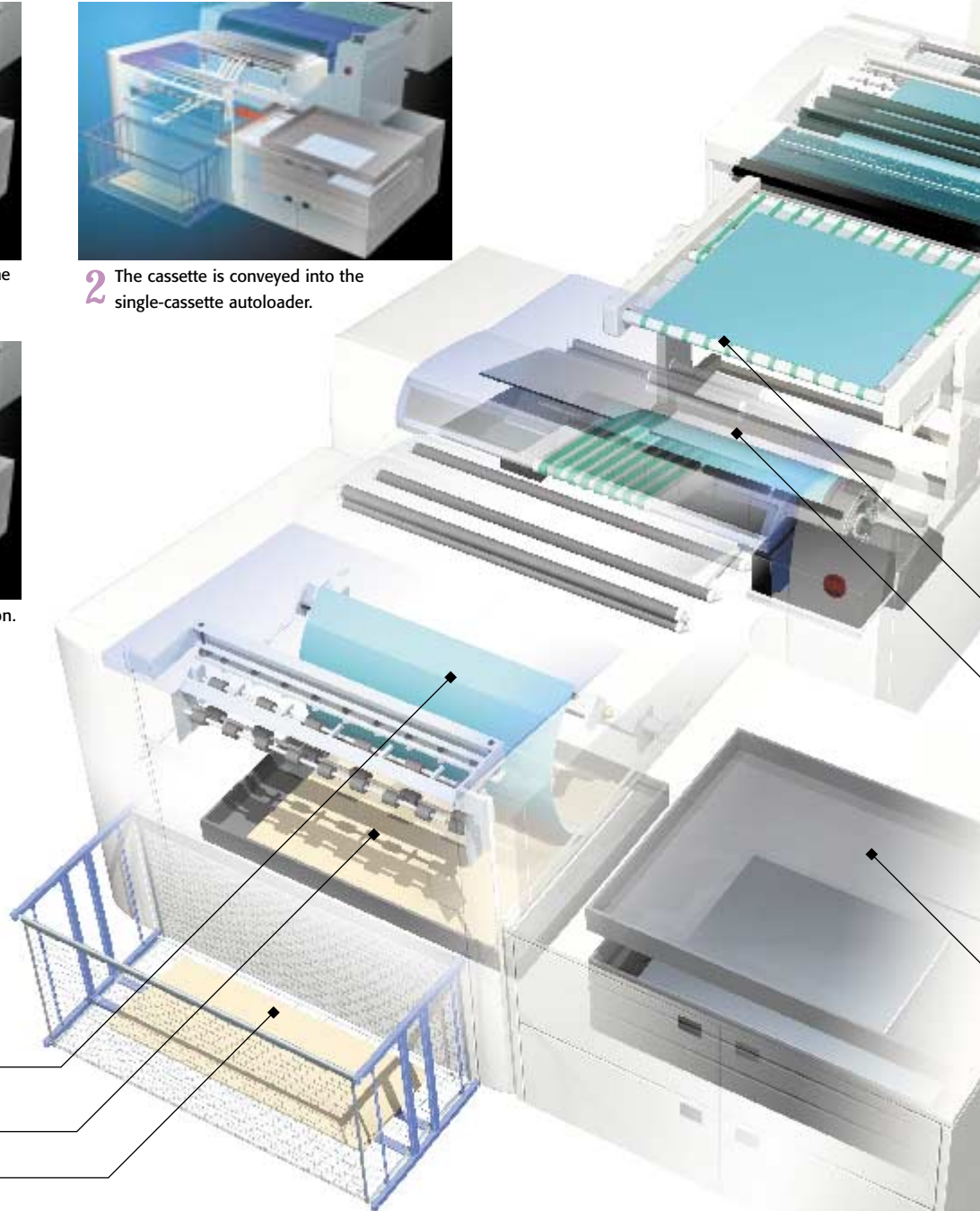

Innovative plate-handling system ensures no contact with front of plate

Sensor automatically detects plate/interleaf paper

External collection box for ejected interleaf paper

Plate loading



1 A sensor moves into place to detect whether the first layer is a plate or interleaf paper.



2 Suction pads grip the backside of the plate (no contact is made with the front) and it is loaded inside the PlateRite.

MA-L8800 multi-cassette autoloader (option)

The MA-L8800 multi-cassette autoloader enables complete automation of the cassette changing and plate loading processes. It is attached as an extension to the single-cassette autoloader. It comes standard with three cassettes, with each cassette holding up to 100 plates. An additional two cassettes are optional. This makes it possible to image up to 500 plates of five different sizes without operator intervention.

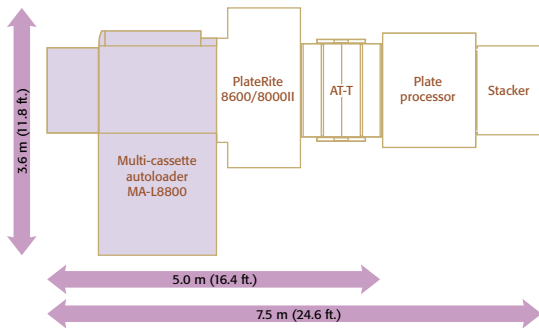
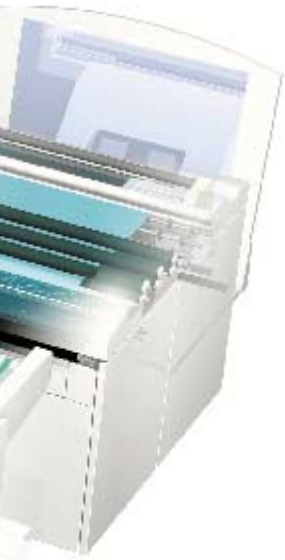

SA-L8800 single-cassette autoloader (option)

The SA-L8800 single-cassette autoloader can hold up to 100 plates. It automatically removes interleaf paper and sends it to an external collection box just before each plate is loaded. No contact is made with the sensitive emulsion side of the plate at any stage during transport, eliminating the risk of damage to the plate. Manual loading is also possible, providing the flexibility to use different sized plates whenever required.

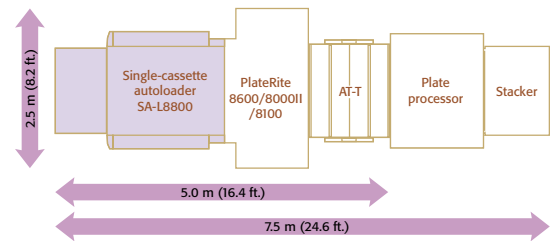

Processor bridge

The AT-T processor bridge automates plate transport between the PlateRite 8600, PlateRite 8000II, or PlateRite 8100 and the inline processor. Exposed plates are moved from the PlateRite onto the bridge. The plates can then be conveyed from the bridge to the plate processor.

SA-L8100 single-cassette autoloader (option)

The SA-L8100 single-cassette autoloader is an affordable unit that offers automated loading of up to 50 plates.* It is somewhat smaller and lighter than the SA-L8800, but like the SA-L8800, it transports plates without any contact to the sensitive emulsion side, so you can be sure your plates will arrive at the platesetter in perfect condition for imaging.

* Manual removal of interleaf paper is required.

Processor bridge completes automated line, and is compatible with major processor types

Inline punching system (option)

MA-L8800
Up to 5 cassettes, each with up to 100 plates
Up to 5 different plate sizes (or all same)
Maximum of 500 plates loaded without operator intervention

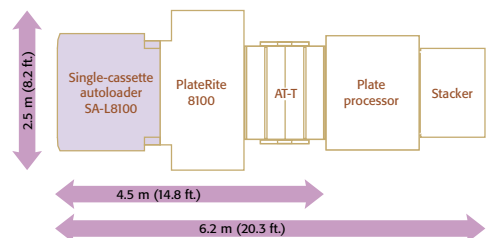

3 The same sensor again detects for plate or interleaf paper.



4 The interleaf paper is lifted away and ejected to an external collection box.

Take full advantage of CTP production with these solutions

Trueflow

Intelligent RIP'ing power for PDF workflows



Built on Adobe technology

Trueflow is built on Adobe's latest interpreter technology, enabling full support for PDF 1.3 and 1.4 files, as well as PostScript 3 files. Screen has used its many years of prepress expertise in workflow systems to build this core into an innovative and reliable PDF workflow system.

Fast platesetters need the right system to drive them. Screen provides this with Trueflow, an intelligent RIP'ing system that enables the control and speed required to match the performance of the PlateRite 8600, PlateRite 8000II, and PlateRite 8100.

Trueflow is the world's first Web browser-operated PDF workflow solution. It is an open production system supporting a range of file formats. It can output Outline PDF, RIP'ed PDF, RIP'ed PostScript, and 1-bit TIFF files.

With Trueflow you are assured of the speed and flexibility you need to efficiently create a high-performance workflow, and can drive that workflow with one of the industry's most advanced workflow solutions.

Hot folders and job tickets for faster workflow

Trueflow brings workflow automation to a new level. Dropping data files into Trueflow's hot folders is all it takes to process jobs automatically. Job tickets can be used to specify high quality trapping or flexible imposition. Trueflow provides your workflow with outstanding late-binding functionality. Changes can be made to any page without affecting the other pages. It's also very easy to add in pages that arrive late. This eliminates delays and keeps jobs ready for fast plate output.

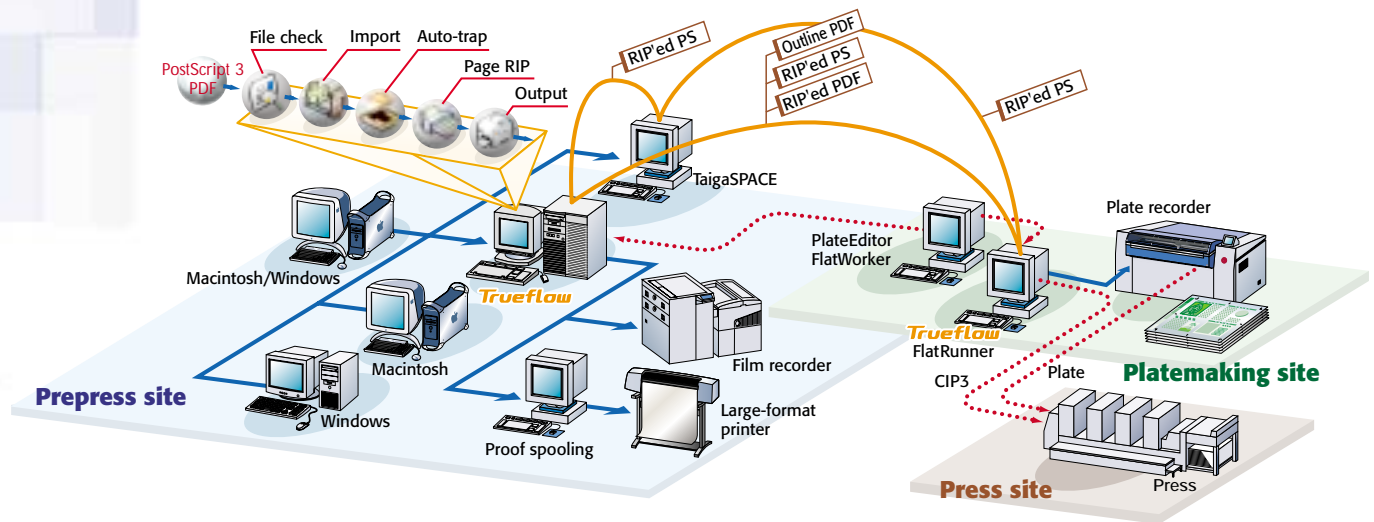

CIP3/CIP4 support

Keeping you on the cutting edge

Screen is a founding member of both CIP3 (Cooperation for Integration of Prepress, Press, and PostPress) and CIP4 (Cooperation for Integration of Processes in Prepress, Press, and PostPress). As part of these initiatives, Screen works with major printing press manufacturers to implement innovations such as PPF (Print Production Format). Implementing solutions such as PPF is another way to reduce makeready times and ensure streamlined production.

Screen continues to work in the industry for further prepress, press, and postpress integration, especially with CIP4's XML-based Job Definition Format (JDF). With Screen, you can be sure that the equipment you use today will be in step with the solutions of tomorrow.

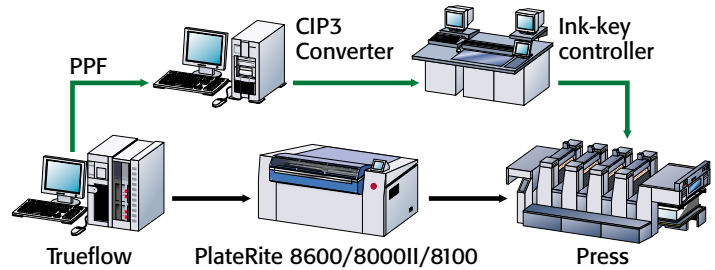

SPEKTA

AM/FM hybrid screening

The PlateRite 8600, PlateRite 8000II, and PlateRite 8100 support Spekta screening. Spekta combines the strengths of both conventional AM screening methods and advanced FM (stochastic) screening. This makes it possible to produce extraordinary quality with ordinary screen rulings.

All the dots in Spekta screens are at least slightly randomized so that moiré and visible rosette patterns can never occur. And by applying FM screening methods to highlights and shadow areas, Spekta produces breathtaking detail and color completely free of jagged edges and broken lines. Spekta screening and the PlateRite 8600, PlateRite 8000II, or PlateRite 8100 make an unbeatable combination.

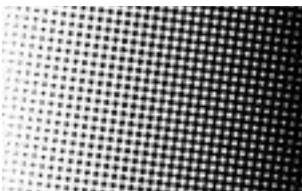

AM screening



Spekta

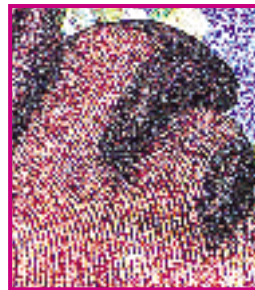

Spekta

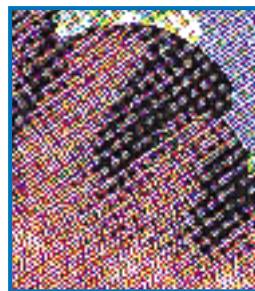

AM screening



Spekta



AM screening

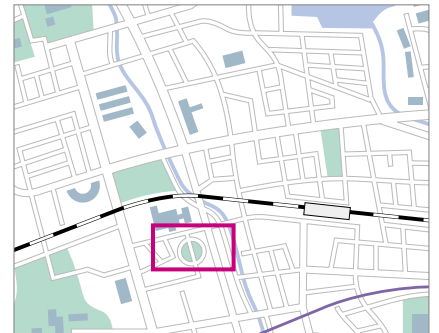

Space requirements

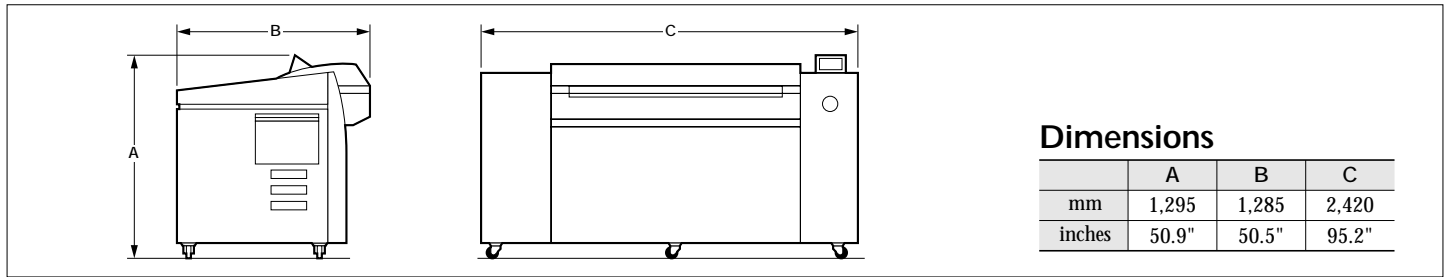

PlateRite 8600/8000II/8100 specifications

Product name	PlateRite 8600	PlateRite 8000II	PlateRite 8100
Recording system	External drum		
Light source	64-channel infrared laser diodes	32-channel infrared laser diodes	16-channel infrared laser diodes
Plate size	Maximum 1,160 x 940 mm (45.6" x 37") / Minimum 450 x 370 mm (17.7" x 14.5")		
Exposure size	Across the drum: Same as plate size Around the drum: Either 16 mm (0.62") or 24 mm (0.94") smaller than the plate size*		
Media	Thermal (infrared sensitive) plates		
Media thickness	0.15 to 0.3 mm (5.9 to 11.8 mil)		
Resolutions	1,200/2,400/2,438/2,540 dpi (optional 2,000/4,000 dpi)	1,200/2,000/2,400/2,438/2,540/4,000 dpi	2,400/2,438/2,540 dpi
Repeatability	±5 microns**		
Productivity	20 plates/hr at 2,400 dpi (1,030 x 800 mm/40.5" x 31.4" plates)***	13 plates/hr at 2,400 dpi (1,030 x 800 mm/40.5" x 31.4" plates)***	8 plates/hr at 2,400 dpi (1,030 x 800 mm/40.5" x 31.4" plates)***
Interface	Fast PIF		
Plate transport	Semi-automatic loading (standard) / Fully-automatic loading (optional)		
Punch systems (optional)	SCREEN, Heidelberg, Protocol, Komori, and others		
Dimensions (W x D x H)	2,420 x 1,285 x 1,295 mm (95.2" x 50.5" x 50.9")		
Weight	Approx. 1,150 kg (2,530 lbs.)		
Environment	23°C ±2°C (73.4°F ±3.6°F), 40% to 70% relative humidity (non-condensing)		
Power requirements	Single phase 200 to 230 V, 35 A, 5.0 kW****	Single phase 200 to 230 V, 25 A, 4.0 kW****	Single phase 200 to 230 V, 11 A, 5.0 kW****

* Use of 8-mm clamps results in 16-mm reduction of exposure size. Use of 12-mm clamps results in 24-mm reduction.

Maximum drum speed of 600 rpm for 8-mm clamps or for plates smaller than 650 mm x 550 mm (25.5" x 1.6").

** Over four consecutive exposures on one plate at 23°C (73.4°F) and 60% relative humidity.

*** Output speed may vary depending on the sensitivity of the media and clamp size selection.

**** Also covers power requirements of SA-L, MA-L, AT-T, and blower unit.

Autoloader specifications

Model name	MA-L8800	SA-L8800	SA-L8100
Plate transport	Fully automatic loading and automatic interleaf removal		Fully automatic loading
Cassette capacity	100 plates per cassette	100 plates	50 plates
No. of cassettes	3 cassettes (standard), additional 2 cassettes (optional)	1 cassette	
Cassette transport	Fully-automatic (horizontal/vertical)	--	
Cleaning function	Cleaning roller (cleans both sides of plate)		
Cassette changeover	2 minutes (between 1st and 5th cassette)		
Dimensions (W x D x H)	3,213 x 2,120 x 1,295 mm (126.5" x 83.5" x 51.0")	1,758 x 2,120 x 1,295 mm (69.2" x 83.5" x 51.0")	1,590 x 1,288 x 1,173 mm (62.6" x 50.7" x 46.2")
Weight	1,250 kg (2,753 lbs.) Plate supply section: 530 kg (1,166 lbs.) Cassette collection section: 720 kg (1,586 lbs.)*	600 kg (1,321 lbs.)	Main unit approx. 180 kg (397 lbs.) Carrier 66 kg (146 lbs.)
Power	Single phase 200 to 230 V ± 10%, 5 A, 1.0 kW**		
Environment	23°C ± 2°C (73.4°F ± 3.6°F), 40% to 70% relative humidity (non-condensing)		
Standard accessories	3 cassettes, interleaf paper collection box	Plate cassette and carrier Interleaf paper collection box	Plate cassette and carrier
Options	Additional plate cassettes and carriers (with cassette dust covers)		

* Increases by 500 kg (1,102 lbs.) when fully loaded with cassettes and plates.

** Powered by main unit.

DAINIPPON SCREEN MFG. CO., LTD.

HEAD OFFICE

• Teranouchi-agaru 4-chome, Horikawa-dori, Kamigyō-ku, Kyoto, 602-8585 Japan/Phone +81-75-414-7610/Fax +81-75-414-7608

SCREEN (USA)

• 5110 Tollview Dr., Rolling Meadows, IL 60008, USA/Phone 847-870-7400/Fax 847-870-0149 www.screenusa.com

DAINIPPON SCREEN (DEUTSCHLAND) GmbH

• Mündelheimer Weg 39, 40472 Düsseldorf, Germany/Phone 0211-4727199/Telex 858-4438 DSSDD D

DAINIPPON SCREEN (U.K.) LTD.

• Michigan Drive, Tongwell, Milton Keynes, Buckinghamshire MK15 8HT, UK/Phone 01908-848500/Fax 01908-848501 www.screen.co.uk

DAINIPPON SCREEN (NEDERLAND) BV

• Bouwerij 46, 1183Xx Amstelveen, Holland/Phone 020-4567800/Fax 020-4567805 www.screeneurope.com

SCREEN FRANCE

• Z.I. Paris Nord II, 12 Rue des Chardonnerets, B.P. 50315, F-95940 ROISSY C.D.G. Cedex, France/Phone 1-48-17-86-00/Fax 1-48-17-86-01

DAINIPPON SCREEN SINGAPORE PTE. LTD.

• 29, Kaki Bukit View, Kaki Bukit Techpark II, Singapore 415963/Phone 67493833/Fax 67499010 www.screensp.com.sg

DAINIPPON SCREEN (CHINA) LTD.

• 6th Floor, 414 Kwun Tong Road, Kwun Tong, Kowloon, Hong Kong/Phone 2953-0038/Fax 2755-8683

Beijing office /Phone 010-6708-9271, 9272, 9273/Fax 010-6505-4975 (China)

Shanghai office /Phone 021-6466-4501/Fax 021-6466-4503 (China)

Guangzhou office/Phone 020-3891-1112/Fax 020-3891-1036 (China)

DAINIPPON SCREEN (TAIWAN) CO., LTD.

• 4F No. 126-1, Ming Tsu West Rd., Taipei, Taiwan/Phone 02-25862711/Fax 02-25914367

DAINIPPON SCREEN (KOREA) CO., LTD.

• 8th Yonsil Bongeub 2/D-48-9-10a, Bongeub-Dong, Joong-Gu, Seoul 100-161, Korea/Phone 02-7766-786/Fax 02-7766-787

DAINIPPON SCREEN (AUSTRALIA) PTY. LTD.

• Unit 2, 207-209 Young Street, Waterloo, NSW 2017, Australia/Phone 02-9310-1314/Fax 02-9310-3566

Internet web site: www.screen.co.jp

- This brochure was made using SPEKTA screening.
- Printed on recycled paper.

We reserve the right to alter product design and specifications without prior notice.