



User Manual



EM – USER MANUAL

CONGRATULATIONS!

You have just purchased and electric motorcycle EM. We welcome you in our customers!

The motorcycle EM trial results from trial passion, the nature and the green technologies. It has been designed and developed with the experience and the knowhow of our team.

Riding and using this motorcycle need warning and recommendations to benefit fully of the advantages offered by this green alternative.

It is essential to read carefully this manual because it contains, firstly the information needed to handle, drive and the starting of this motorcycle. Secondly, it contains the information relatives to the maintenance and the control of the bike.

This manual will allow you to keep your good in a perfect working state in the safer way possible.

If you have any question or any doubt, please contact us by phone or email

0033 467 411 090

emotion.sav@gmail.com

Electric Motion's team wishes you to enjoy riding this motorcycle.



Reminder Notice

1. CHARGE OF THE BATTERY

(USER MANUAL// 3.2. RIDING OF THE MOTORCYCLE p37)

2. CHARGING OF THE BATTERY PACK

(USER MANUAL// 2.1.CHARGING OF THE BATTERY PACK p15)

3. BATTERIES INTERCHANGEABILITY TRIAL ELECTRIC MOTION

(USER MANUAL// 2.2. MOUNTING AND REMOVING OF THE BATTERY PACK p25)

4. CHARGERS INTERCHANGEABILITY TRIAL ELECTRIC MOTION

(USER MANUAL// 1.3 CHARGER p8)

5. USE OF THE BATTERY

/ ! ** After use your battery, **be sure that it is switch off:

- **Indicator of the battery on the battery pack = Switch off,**
- **Indicator of the general commuter on the handlebar. = Switch off**

/ ! ** This indicator will switch off when your motorcycle **AND your battery will be switch off.

The extinction of this indicator will occur after several minutes.

(USER MANUAL// 1.5. STEERING ELEMENTS AND INFORMATION LIGHT p11)

6. STORAGE OF THE BATTERY PACK

(USER MANUAL// 2.3 STORAGE OF THE BATTERY PACK p34)

7. BIKE'S PARAMETER

/ ! ** We remind you that it is **ABSOLUTELY FORBIDDEN to change your ELECTRIC MOTION bike's settings on your own.

Concerning the information that you could find on Internet, please **do not change or adapt the parameters or the software** of your electric bike by parameters and/or program not provided by ELECTRIC MOTION.

The software and the parameters adjustment are specifics to our electric bike, all others softwares or parameters are not compatible with our electric bike made by ELECTRIC MOTION. By using a different software or changing parameters, please note that you will damage your bike.

Moreover, all those actions will automatically **cancel your bike warranty.**

SUMMARY

1. GENERAL INFORMATION	5
1.1. RECEPTION	5
1.2. BATTERY PACK	6
1.3. CHARGER.....	7
1.4. MOTORCYCLE.....	9
1.5. STEERING ELEMENTS AND INFORMATION LIGHT	10
1.5.1. STEERING ELEMENTS.....	10
1.5.2. SETTING.....	11
1.5.3. INFORMATION LIGHTS	12
2. BATTERY PACK.....	14
2.1. CHARGING OF THE BATTERY PACK	14
2.1.1. 10A CHARGER.....	15
2.1.2. 15A CHARGER.....	20
2.2. MOUNTING AND REMOVING OF THE BATTERY PACK	24
2.2.1. MOUNTING OF THE BATTERY PACK	25
2.2.2. REMOVING OF THE BATTERY PACK	29
2.3. STORAGE OF THE BATTERY PACK.....	33
3. USING OF THE MOTORCYCLE.....	34
3.1. STARTING OF THE MOTORCYCLE	34
3.2. RIDING OF THE MOTORCYCLE.....	36
3.2.1. SECURITY	36
3.2.2. SETTINGS	37
3.2.3. RIDING.....	37
3.2.4. ELECTRONIC CLUCH (Sport model ou option)	38
3.2.5. RIDING IN THE WATER	39
3.2.6. TEMPERATURES OF USING.....	39
3.2.7. CHARGE	39
3.2.8. DISCHARGE (USING)	39
3.2.9. STOPPING OF THE MOTORCYCLE	40
4. MAINTENANCE.....	42
4.1. CLEANING.....	42
4.2. TRANSMISSIONS	42
4.2.1. PRIMARY TRANSMISSION.....	43
4.2.2. SECONDARY TRANSMISSION.....	44



1. GENERAL INFORMATION

1.1. RECEPTION

If you receive the motorcycle and the battery pack separately, please follow the procedures: **REMOVING THE COVER** and **MOUNTING THE BATTERY PACK**.

If you receive the motorcycle on a palette, the footrests and the handlebar are not assembled on the motorcycle.

- FOOTRESTS

The footrests are on the cartoon box with your motorcycle. You must assemble the footrests following the following picture:



- HANDLEBAR

The handlebar needs to be assembled following the following picture; a plastic strip fastens the rubber protection:

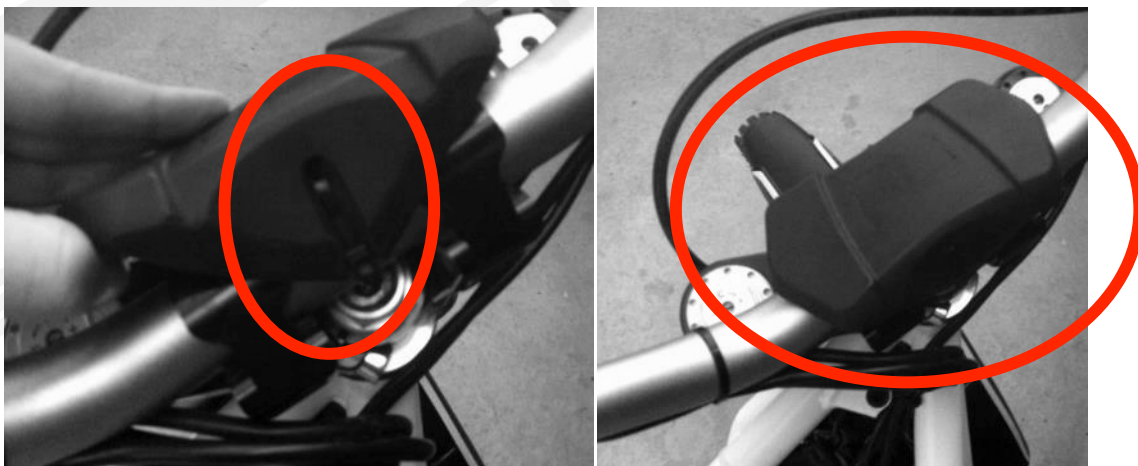



1.2. BATTERY PACK

**MAIN
CONNECTOR**

**BATTERY
SWITCH**

**CHARGING
CONNECTOR**

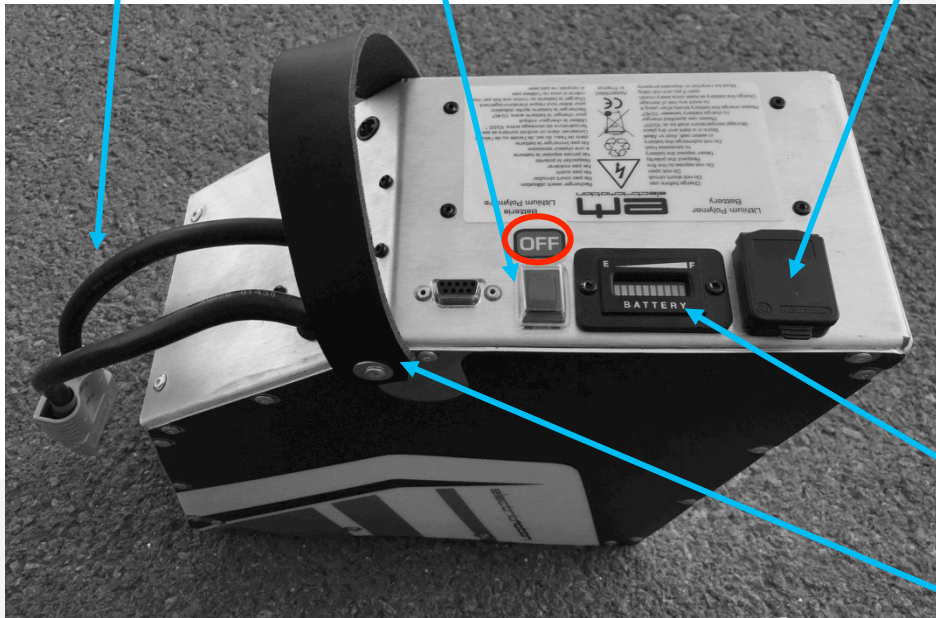

**BATTERY
LEVEL LED
INDICATOR**

HANDLE

Once you receive the motorcycle and the battery pack, you must charge it.

Please follow the procedure **CHARGING BATTERY PACK**

The first charge will be quite quick (30 min to 1 h).

The entire range will be reached after around 10 charging/discharging cycles.

The standard charging time will be around 2 h (if the battery pack is fully discharged).

**/\ \ WARNING /\ **

If you happen by mistake, forgetting to turn off the battery after use or not to use the bike on for 20 minutes, it will turn into "sleep" mode. This safety cut the relay **AND THE LED INDICATOR, BUT THE BATTERY IS ONLY IN "SLEEP MODE"**. TAKE CARE TO SWITCH OFF THE BATTERY WITH THE MAIN SWITCH ON THE OFF POSITION.

You must in this case cut the battery before restarting or before recharging.



1.3. CHARGER

**!! ** CHARGERS INTERCHANGEABILITY TRIAL ELECTRIC MOTION

- ✓ **The Grey chargers** are dedicated to batteries:
Trial batteries (before 2016) AND ESCAPE batteries (Since 2016).

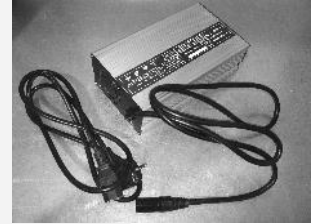

- ✓ **The Black chargers** are dedicated to batteries:
Trial Batteries (since 2016)



The two different chargers versions are not interchangeable.

In case of wrong use, there is no influence on the security

Only an inoperative of the charger.

The charger provided with the motorcycle will permit you to recharge your battery pack.

!! ** Please select, on the charger, the voltage used in the country you are using the charger (115V or 230V**).



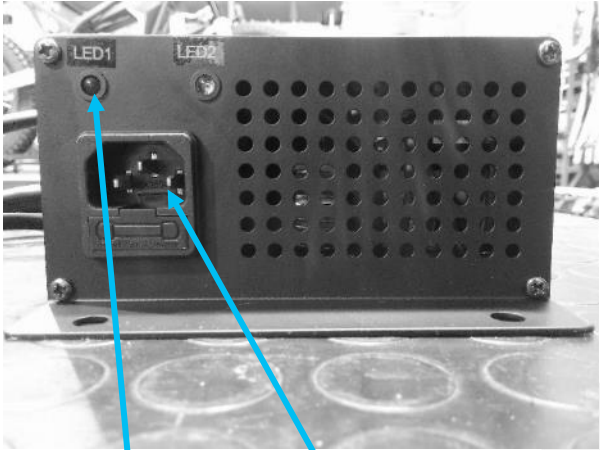

**INLET
CONNECTOR**

**110V/230V
CONNECTOR**



WORKING LEDS



1.4. MOTORCYCLE

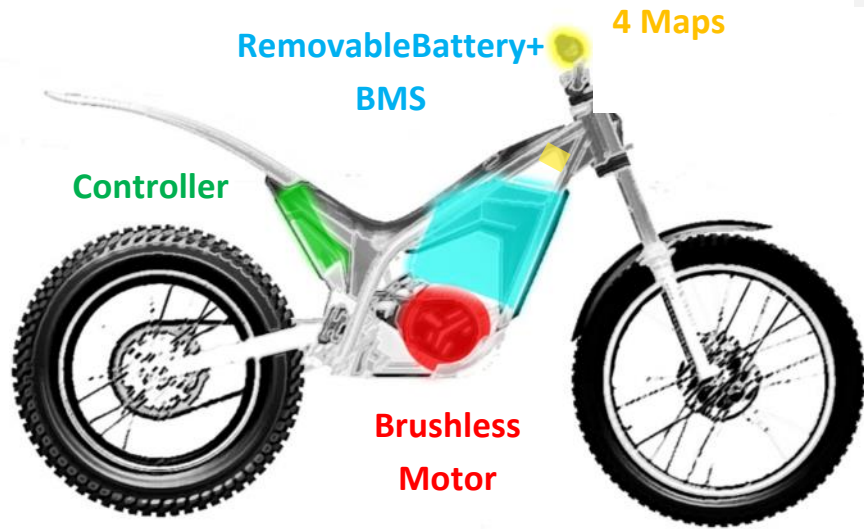

The serial number of the motorcycle is noticed on the steering pipe, on the front part of the frame.





1.5. STEERING ELEMENTS AND INFORMATION LIGHT

1.5.1. STEERING ELEMENTS

ELS (ELECTRONIC
CLUTCH)

REAR BRAKE
(OPTION)

FRONT BRAKE

THROTTLE



MAIN CONTACTOR
& MOTOR BRAKE

SECURITY SWITCH

TRIAL MAP SWITCH

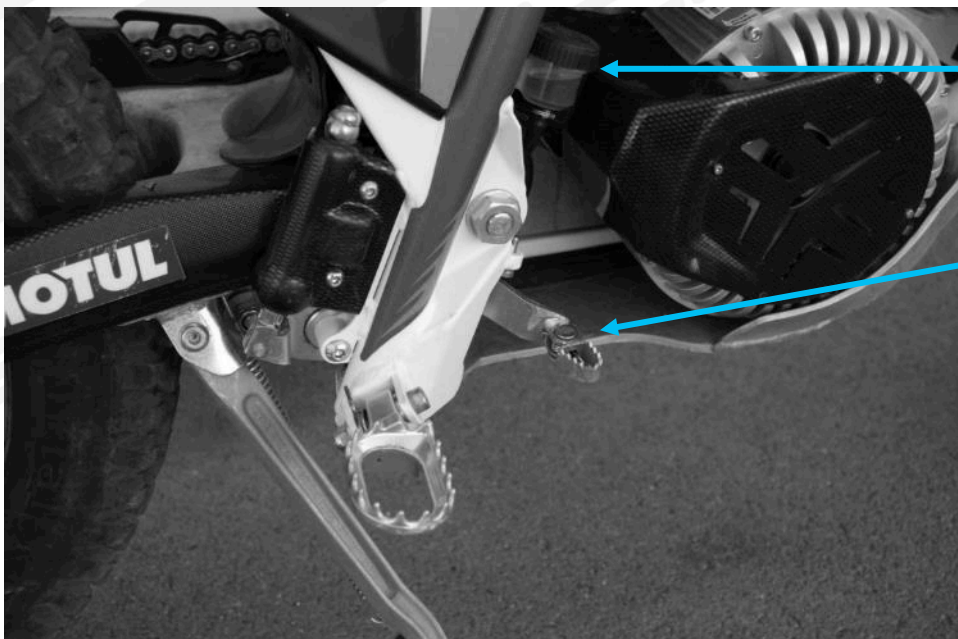

REAR BRAKE
LIQUID TANK

REAR BRAKE
PEDAL



1.5.2. SETTING

The motorcycle has a setting harness with 2 riding modes.

It is located inside the front part of the frame.

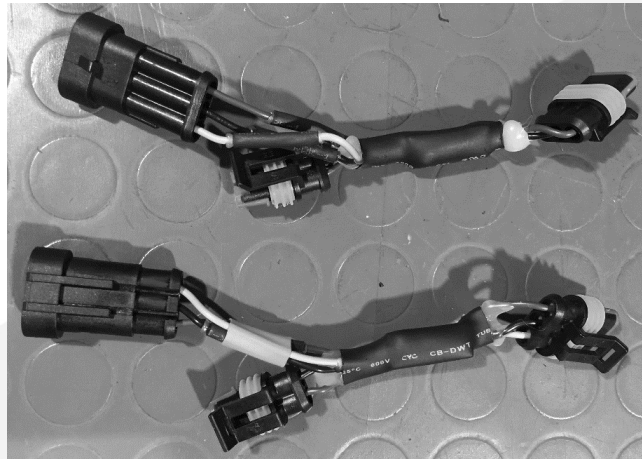

(More detailed explanations in the part 4.2.2 SETTINGS)



1.5.3. INFORMATION LIGHTS

- STANDARD MAIN COMMUTER

On the left of the handlebar, the general commuter has a green light, which indicates the motorcycle is working **OR** when the battery is ON.

/! This indicator will switch off when your motorcycle **AND** your battery will be switch off.

The extinction of this indicator will occur after several minutes.



Ignition indicator

Circuit breaker

Engine brake

- HOMOLOGATION MAIN COMMUTER

The operating of the ignition indicator is the same as the Standard commuter.



Ignition indicator

Dimmed headlights, full head lights

Electric speed reducer

Horn

Turn signal

Circuit breaker

In front

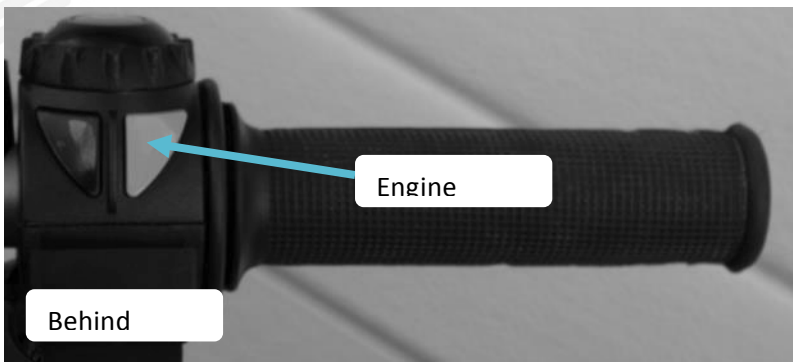

Engine

Behind



Hand position to activate the brake engine



- BATTERY LED INDICATOR

The battery pack has a led indicator, which shows the remaining energy capacity.



There are 10 LEDs:

- The 7 first are GREEN,
- 2 ORANGE
- 1 last RED.

**/! ** The decreasing of energy can be very quick in the 3 last red ones.

**INDICATOR EXTINCTION MAY TAKE SOME TIME
(MINUTES)**



2. BATTERY PACK

2.1. CHARGING OF THE BATTERY PACK

/! If you use a 15a charger you have to follow the suitable procedure.

- The phenomenon of Sparking is normal when it connects to battery because of high current.
- This charger is designed for charging LITHIUM POLYMER type batteries only.
- Avoid charging the wrong type of battery
- The battery may be damaged if LED2 cannot be changed to green after a long time of charging
- Always place the charger in well-ventilated and dry environments
- The charger is designed with aluminum case as its heat sink. Do not cover it to avoid the case from being over heated while charging
- Please attention to DC terminal:
 - BROWN (+) Positive terminal, Blue (-) Negative terminal
- DO NOT disassemble charger. Take it to a qualified service person when service or repair is required.



2.1.1. 10A CHARGER

!!! If you use this charger (10a), you must follow the next procedure to charge your battery pack.



The charging of the battery pack needs to be followed very precisely.



1- OPEN THE CHARGING CONNECTOR TAP

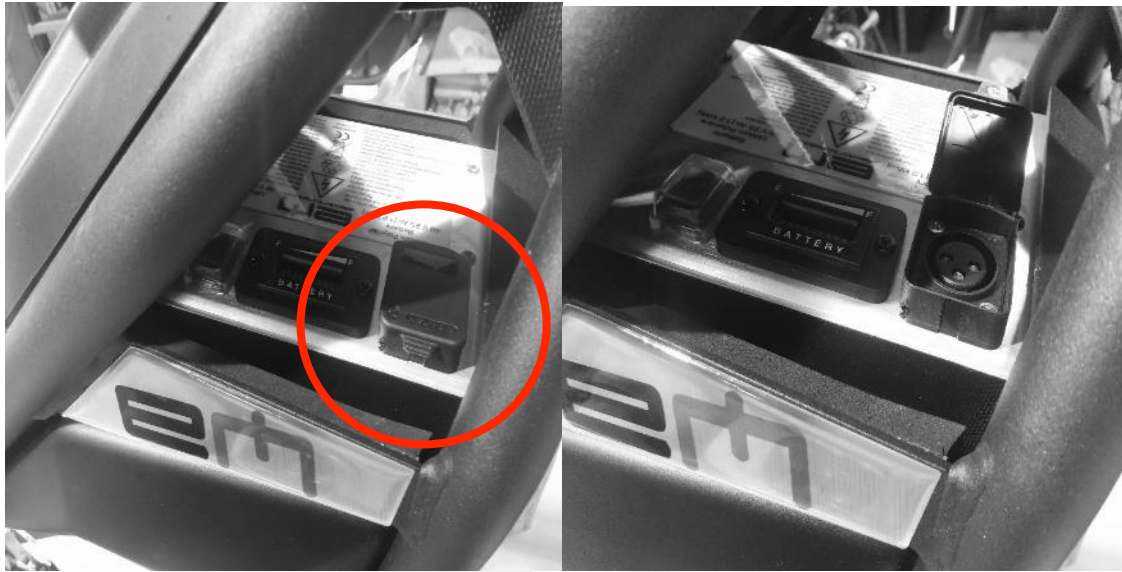

2- CONNECT THE CHARGER CONNECTOR TO THE BATTERY PACK CONNECTOR

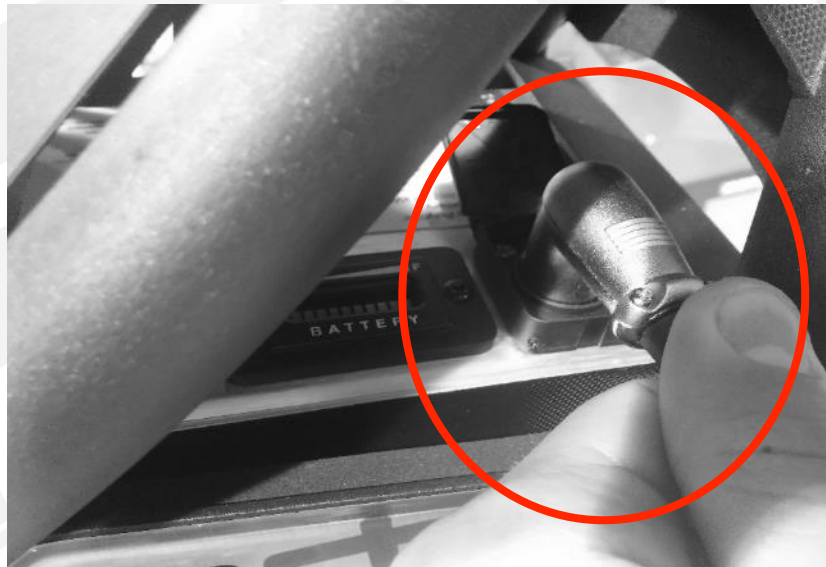



3- CONNECT THE CHARGER TO THE OUTLET



-- LED1: RED

- LED2: NOT LIGHTING

=>THE CHARGER IS CORRECTLY PLUGGED



4- SWITCH ON THE CHARGER

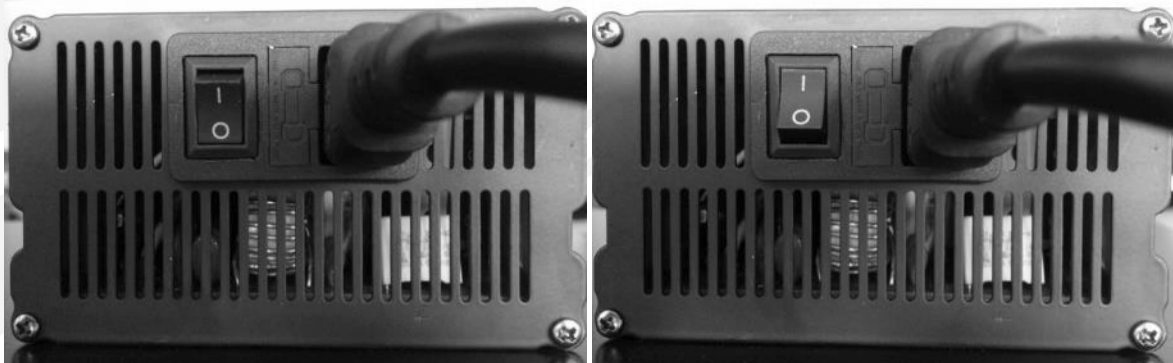

THE LED OF THE CHARGER ARE:

- LED1: RED

- LED2: GREEN



=>THE CHARGER IS CORRECTLY PLUGGED AND SWITCHED ON



5- SWITCH ON THE BATTERY PACK

THE LED INDICATOR ON THE BATTERY PACK LIGHT (red circle)

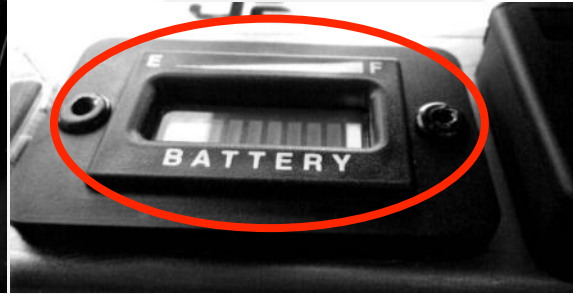

THE LED OF THE CHARGER ARE:

- LED1: RED
- LED2: RED

=>THE BATTERY PACK IS CHARGING



6- - AT THE END OF THE CHARGE

THE LED OF THE CHARGER ARE:

- LED1: RED
- LED2: GREEN

=>THE BATTERY PACK IS CHARGED





7- SWITCH OFF THE BATTERY PACK (THE LED INDICATOR MUST STOP TO LIGHT)

8- SWITCH OFF THE CHARGER

9- UNPLUG THE CHARGER FROM THE BATTERY PACK

10- UNPLUG THE CHARGER FROM THE OUTLET

THE BATTERY PACK CAN BE CHARGED OUT OF THE MOTORCYCLE

FOLLOWING EXACTLY THE SAME PROCEDURE.

THE CHARGER MUST BE UNPLEGGED FROM THE OUTLET BETWEEN 2 CHARGING PROCEDURES.



2.1.2. 15A CHARGER

!!! If you use this charger (54.6v 15a), you must follow the next procedure to charge your battery pack.



The charging of the battery pack needs to be followed very precisely



1- OPEN THE CHARGING CONNECTOR TAP

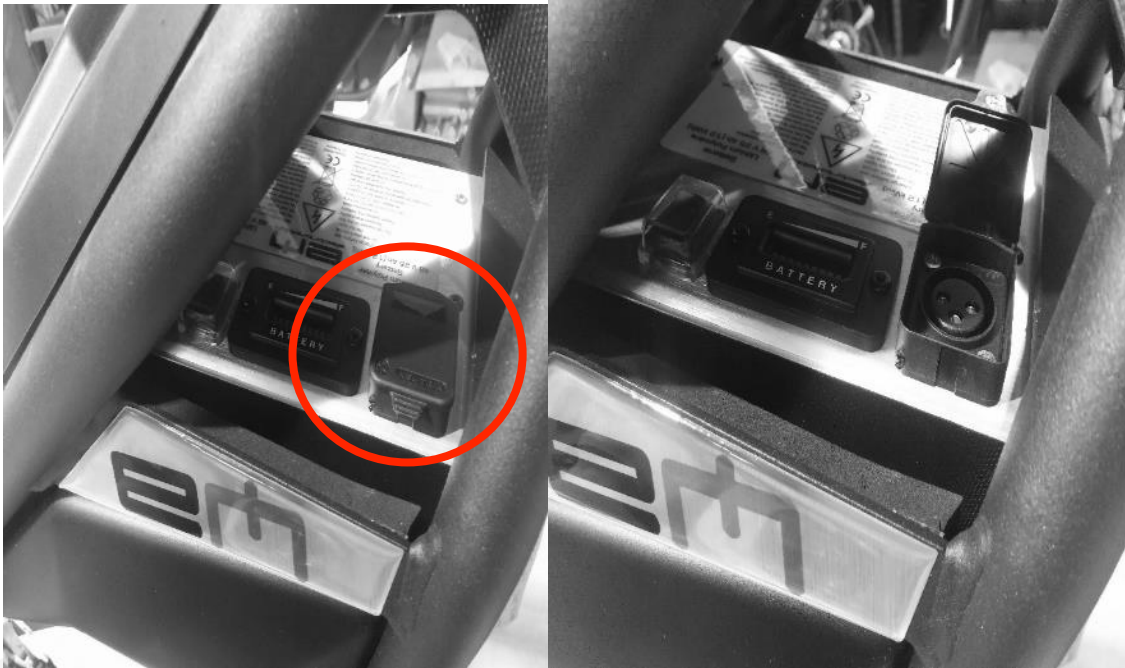

2- CONNECT THE CHARGER CONNECTOR TO THE BATTERY PACK CONNECTOR

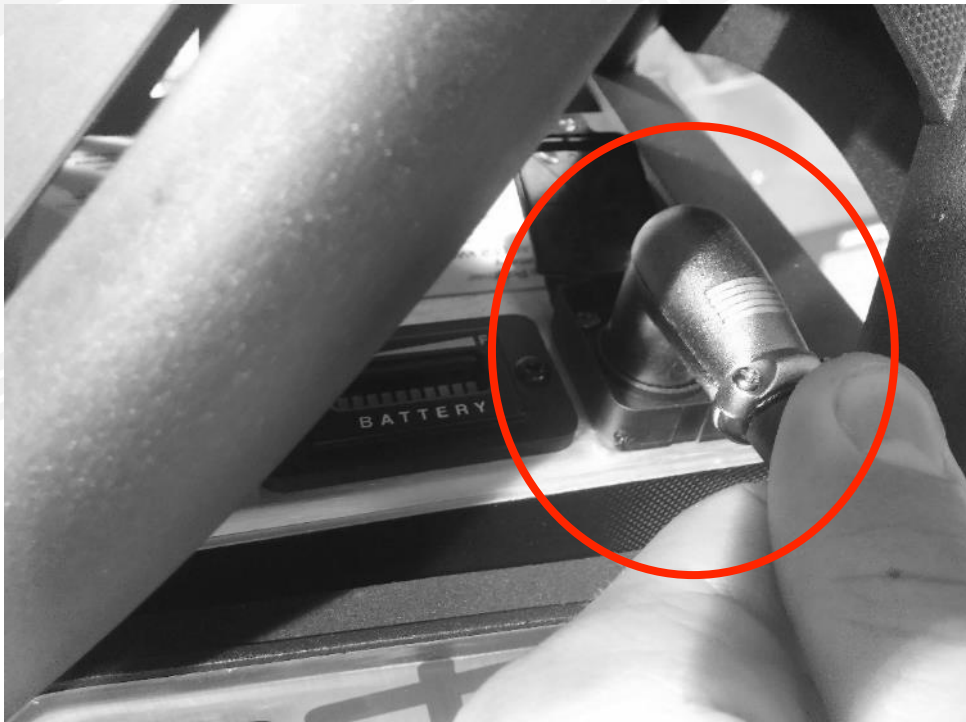



3- PLUG THE CHARGER TO THE OUTLET



THE LED OF THE CHARGER ARE:

- LED1: RED
- LED2: GREEN



=>THE CHARGER IS CORRECTLY PLUGGED

4- SWITCH ON THE BATTERY PACK

THE LED INDICATOR LIGHT (red circle)



THE LED OF THE CHARGER ARE:

- LED1: RED
- LED2: RED

⇒ **THE BATTERY PACK IS CHARGING**





5- AT THE END OF THE CHARGE

THE LED OF THE CHARGER ARE:

- LED1: RED

- LED2: GREEN



=>THE BATTERY PACK IS CHARGED

6- SWITCH OFF THE BATTERY PACK (THE LED INDICATOR MUST STOP TO LIGHT)

7- UNPLUG THE CHARGER FROM THE OUTLET

8- UNPLUG THE CHARGER FROM THE BATTERY PACK

THE BATTERY PACK CAN BE CHARGED OUT OF THE MOTORCYCLE

FOLLOWING EXACTLY THE SAME PROCEDURE

THE CHARGER MUST BE UNPLEGGED FROM THE OUTLET BETWEEN 2 CHARGING PROCEDURES.

THE CHARGING PROCEDURE OF THE BATTERY PACK IS FINISHED



2.2. MOUNTING AND REMOVING OF THE BATTERY PACK

!! INTERCHANGEABILITY OF TRIAL BATTERIES ELECTRIC MOTION

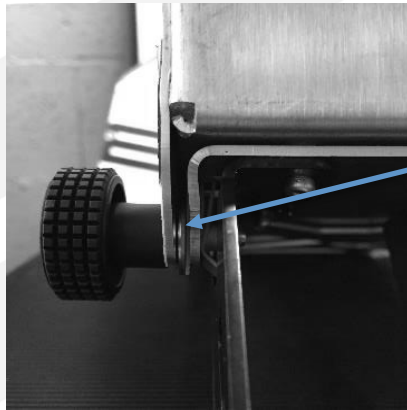
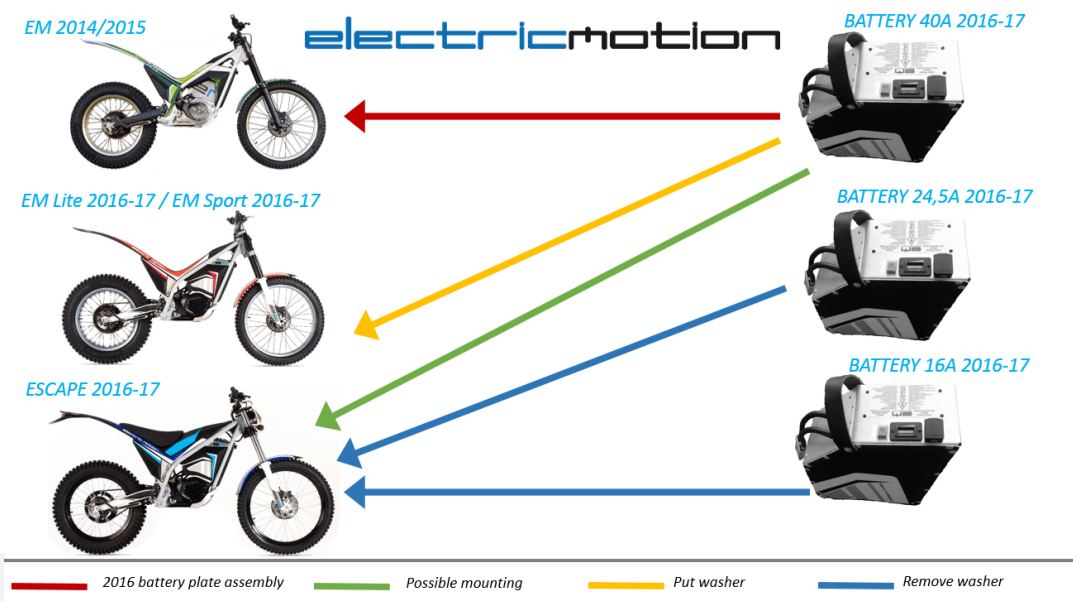

Washer 0R001-06018-01-00
between the lateral plate and the
battery (on each side)

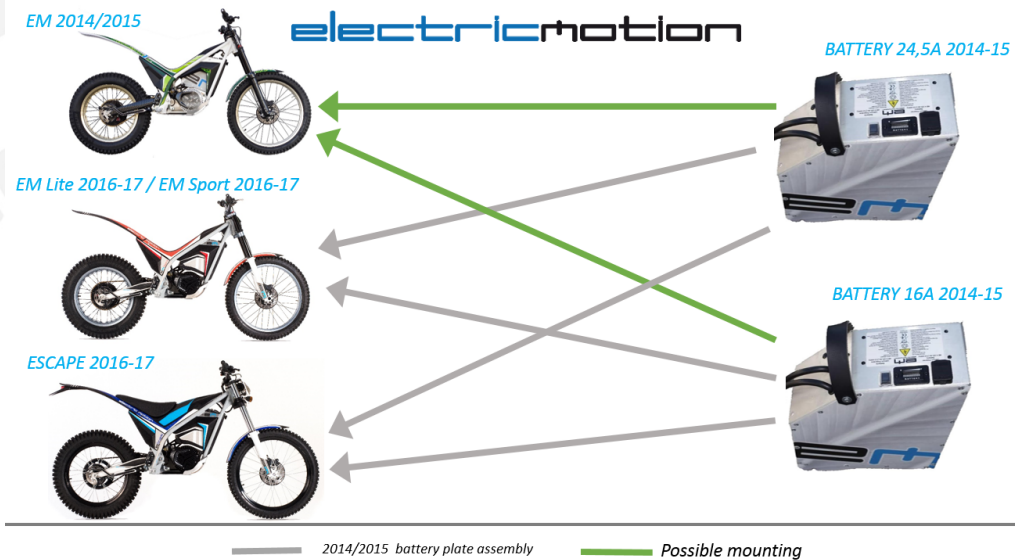



2.2.1. MOUNTING OF THE BATTERY PACK

- 1- TAKE THE BATTERY PACK BY THE STRAP WITH ON HAND



- 2- HELP THE MOVING WITH THE OTHER HAND



DO NOT HOLD THE BATTERY PACK BY THE POWER CABLES!



3- PUT THE BATTERY PACK IN PLACE



4- VERIFY THE ALIGNMENT OF THE 3 FIXING HOLES



5- SCREW THE FRONT SCREW





6- SCREW THE LATERAL SCREWS AND VERIFY THE TIGHTENING OF THE 3 FIXING SCREWS



7- PLUG THE BATTERY PACK TO THE MOTORCYCLE

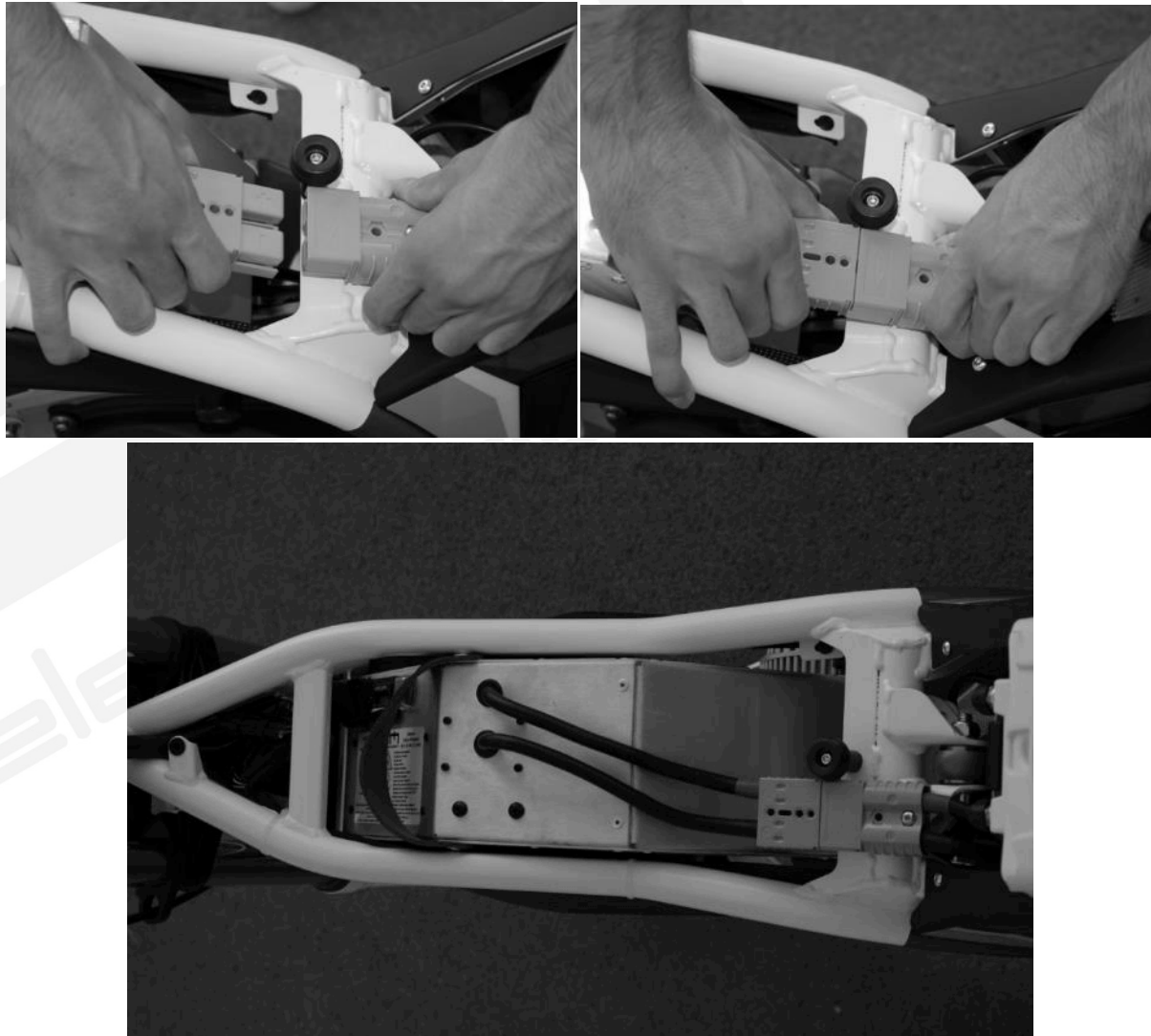



8- IMPLEMENTATION OF THE COVER

Put the cover in place on the motorcycle



The cover is fixed by a strut and 2 screws (red circles)

Screws the 2 fixing screws



THE MOUNTING PROCEDURE OF THE BATTERY PACK IS FINISHED



2.2.2. REMOVING OF THE BATTERY PACK

1- REMOVE THE COVER

- Unscrew the 2 screws



- Remove the cover

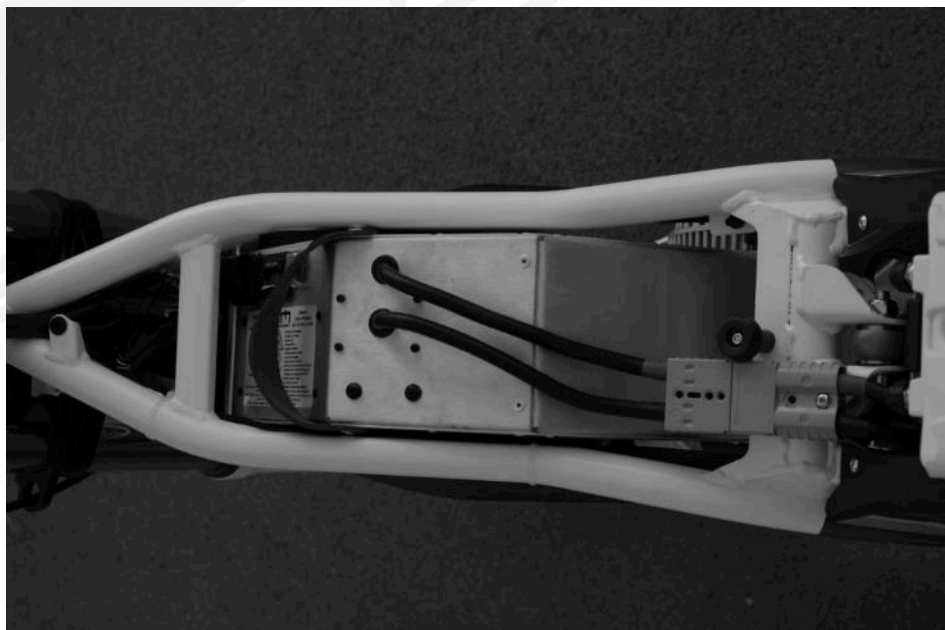



2- VERIFY THE BATTERY PACK IS SWITCHED OFF (BATTERY SWITCH IN OFF POSITION)



!! BE SURE THAT THE LIGHT ON THE HANDLEBAR IS OFF

If it is not :

- Wait **minutes**

if it remains lighting **after minutes**:

- Repeat the procedure SWITCH ON / SWITCH OFF of the battery pack until it switches off.

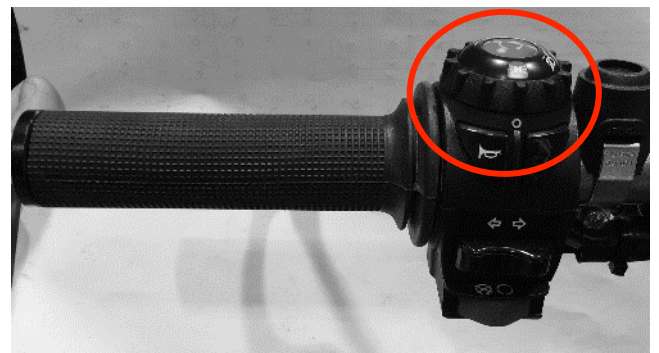

**INDICATOR EXTINCTION AND THE BATTERY LED INDICATOR
MAY TAKE SOME TIME (MINUTES)**



UNPLUG THE MAIN CONNECTOR



DO NOT PULL THE POWER CABLES OF THE BATTERY PACK

3- REMOVE THE FRONT FIXATION SCREW



4- UNSCREW THE LATERAL FIXATION SCREWS (around 5 mm)





5- TAKE THE BATTERY WITH THE STRAP WITH ONE HAND



DO NOT HOLD THE BATTERY PACK BY THE POWER CABLES!

6- HELP THE MOVING WITH THE OTHER HAND



THE REMOVING PROCEDURE OF THE BATTERY PACK IS FINISHED



2.3. STORAGE OF THE BATTERY PACK

!! \ IF YOU WANT TO STORE THE BATTERY PACK, YOU HAVE TO TAKE SOME PRECAUTIONS:

- Before storing the battery the pack must be fully charged and you must insure the battery is switched OFF,
- Inspect and charge the battery every 8 weeks, even if it is not used,
- Discharge the battery to the orange zone on the meter and a fully recharge every 2 months. (please switch battery off after recharge),
- For a battery storage superior to 3 months, charge your battery until 80% by respecting the following voltage:
 - o 43-44V for 13S batteries,
 - o 46-47V for 14S batteries,
- Make sure that the charger and the battery are switched OFF once the charge is finished,
- Do not store the battery pack under 10°C, ideal is between 15°C and 20°C,
- Do not store the battery pack in wet atmosphere, do not store the battery pack exposed to the sun,
- Remove the battery pack is if is necessary from the bike.

!! \ FAILURE TO TURN OFF BATTERY SWITCH:

- Failure to turn off switch may result in low voltage on the battery,
- Low voltage is under 3V per cell:
 - o 39V for 13S batteries,
 - o 42V for 14S batteries.
 - o

Please contact ELECTRIC MOTION technical service
+33 (0) 4 67 41 10 90 // emotion.sav@gmail.com

ANY OPERATION RESULTING IN A LOW VOLTAGE CONDITION THAT REQUIRES A REFRESHING AND BALANCING THE CELLS WILL VOID THE BATTERY WARRANTY



3. USING OF THE MOTORCYCLE

3.1. STARTING OF THE MOTORCYCLE

- 1- START THE BATTERY PACK (THE LED INDICATOR SHOWS THE LEVEL OF THE BATTERY PACK)

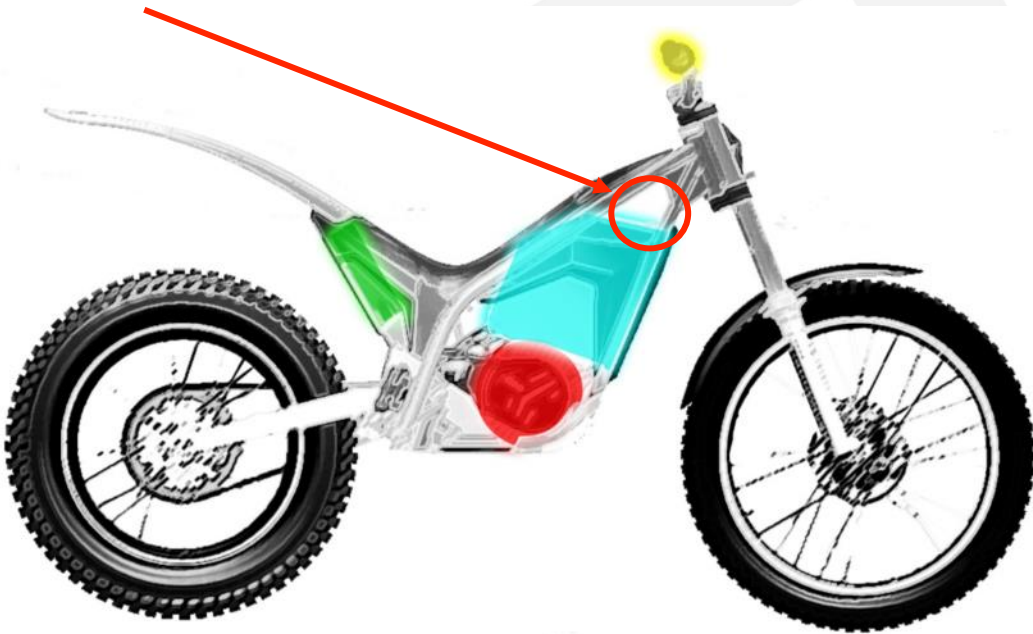



2- STARTING THE GENERAL SWITCH



3- STARTING THE SECURITY SWITCH (put the magnet on the base)



**/\ \ WARNING /\ **

If you happen by mistake, forgetting to turn off the battery after use or not to use the bike on for 20 minutes, it will turn into "sleep" mode. This safety cut the relay **AND THE LED INDICATOR BATTERY. IT INDUCE THE LED INDICATOR IS OFF BUT THE BATTERY IS IN SLEEP MODE, BE SURE TO TURN OFF THE BATTERY.**

You must in this case cut the battery before restarting or before recharging.

**ATTENTION: WHEN THE MOTORCYCLE IS RUNNING,
THERE IS NO NOISE!**



3.2. RIDING OF THE MOTORCYCLE

3.2.1. SECURITY

BEFORE RIDING, CHECK YOU HAVE ALL THE SECURITY EQUIPMENT:

- HELMET
- GLOVES
- ADAPTED CLOTHES
- SECURITY SWITCH (fixed to your wrist to secure the motorcycle if you fall)



**ATTENTION: WHEN THE MOTORCYCLE IS RUNNING,
THERE IS NO NOISE!**



3.2.2. SETTINGS

MAPS HARNESS

THE MOTORCYCLE HAS 2 RIDING MODES

Riding modes depends of the motorcycle version

- ✓ EM Sport : TRIAL 1 / TRIAL 2
- ✓ EM lite : TRIAL 1 / TREK
- ✓ Escape : TRIAL 1 / TREK

Riding mode description below

Riding modes are selectable with the maps switch on the handlebar.

The two different harness are available in option and easily removable.

The sport harness has a red heat shrinkable tube

It is located inside the front part of the frame.

1- TREK

The second mode is made for trekking, the acceleration and maximum speed are more important

2- TRIAL 1

The third riding mode has progressive acceleration and 95% maximum speed

It is made for difficult grip conditions.

3. TRIAL 2

The fourth riding mode has direct acceleration and 100% maximum speed.

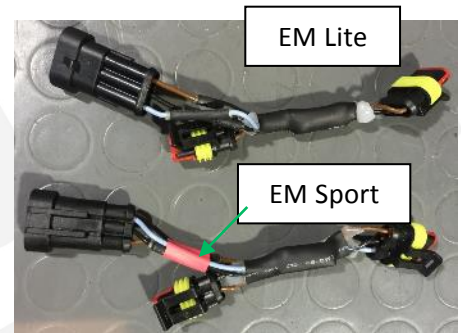

3.2.3. RIDING

During the first ridings, be careful, electric motorcycle is quite different than Internal Combustion Engine motorcycles (2 or 4 strokes).

Begin with the first riding modes to discover this motorcycle.

Go to other MAPS if the riding of the motorcycle is OK.

For trial application, replace the front 11 teeth sprocket by the 9 teeth furnished sprocket.



3.2.4. ELECTRONIC CLUCH (Sport model ou option)

To be perfectly adapted to trial driving, the EM 5.7 has an electronic system: ELS.



The ELS system (Electric Lever Switch) allows you:

- To cut instantly the power of the motorcycle.
- With the combined effect of the throttle and the ELS lever, to have a very precise action of throttle.
- Like a thermal engine clutch, to have instantly the full power when needed.

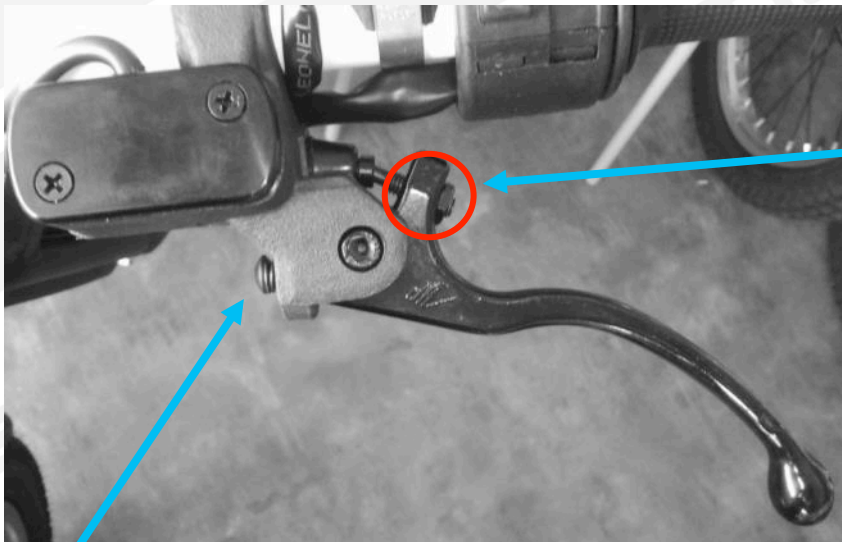

Crewtrigger point

Adjusting screw

Distance of the lever



3.2.5. RIDING IN THE WATER



IF DICULTIES OR STOP IN THE WATER, SWITCH OFF THE MOTORCYCLE (MAIN CONTACTOR AND BATTERY PACK) TO AVOID THE MOTORCYCLE FALLS RUNNING IN THE WATER

3.2.6. TEMPERATURES OF USING

!! To enjoy completely your motorcycle, please respect the charge and discharge condition.

3.2.7. CHARGE

The charging can be done only above 10°C

We recommend to charge between 10°C and 40°C

3.2.8. DISCHARGE (USING)

The battery can be discharged on a bigger temperature range from -15°C to 55°C

You must know that the time range is really affected by the temperature. See the chart below:

TEMPERATURE (°C)	-15	-10	0	10	25	40	55
RANGE REDUCTION	-30%	-25%	-15%	-10%	-0%	-3%	-4%



3.2.9. STOPPING OF THE MOTORCYCLE

1- DISCONNECT THE SECURITY SWITCH (remove the magnet of the base)

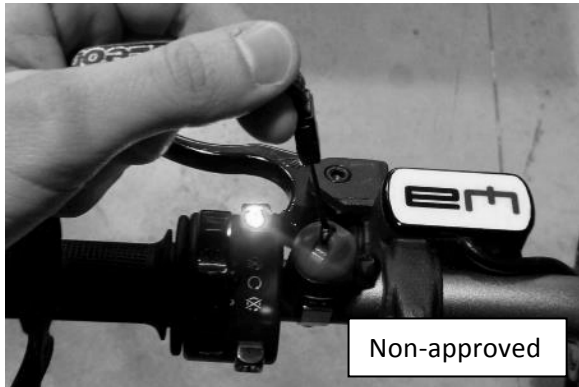

2- SWITCH OFF THE GENERAL SWITCH

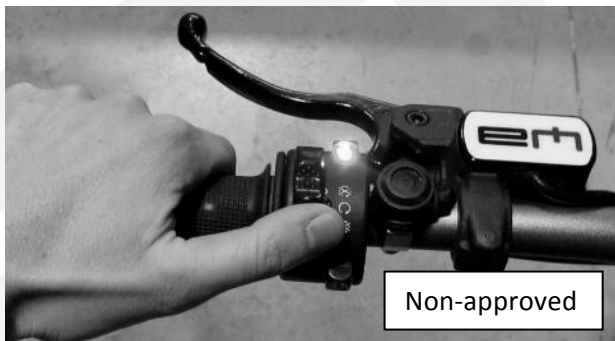



3- SWITCH OFF THE BATTERY PACK : THE LED INDICATOR MUST STOP TO LIGHT



During the first using sessions, it is possible the battery pack do not switch off correctly. To avoid this problem, repeat the operations SWITCH ON/SWITCH OFF of the battery pack until it switch off.

AFTER EACH USING, YOU MUST RECHARGE THE BATTERY PACK. EVEN MORE IF YOU DEEPLY DISCHARGED IT

DISCHARGE THE BATTERY TO THE ORANGE ZONE ON THE METER AND A FULLY RECHARGE **EVERY 2 MONTHS (PLEASE SWITCH BATTERY OFF AFTER RECHARGE)**



4. MAINTENANCE

4.1. CLEANING

Concerning the water cleaning of the motorcycle:

- 1- REMOVE THE BATTERY PACK (FOLLOWING PROCEDURE REMOVING OF THE BATTERY PACK)
- 2- WASH THE MOTORCYCLE WITHOUT FOCUSING ON THE ELECTRICAL COMPONENTS AND THE EXTERNALS BEARINGS. (USE MOTUL MOTO WASH AND MOTUL WHEEL CLEANER)
- 3- DRY THE MOTORCYCLE (ELECTRICAL CONTACTS) BEFORE THE MOUNTING OF THE BATTERY PACK.

! \ DO NOT CLEAN THE HANDLEBAR

WITH A PRESSURE WASHER

Concerning the cleaning of the battery pack:

- 1- SWITCH OFF THE BATTERY PACK.
- 2- USE ONLY A WET CLOTH OR SPONGE.
- 3- DRY PROPERLY THE BATTERY PACK.

4.2. TRANSMISSIONS

The motorcycle has 2 direct transmissions, the PRIMARY (circle red) one and the FINAL transmission (circle blue)

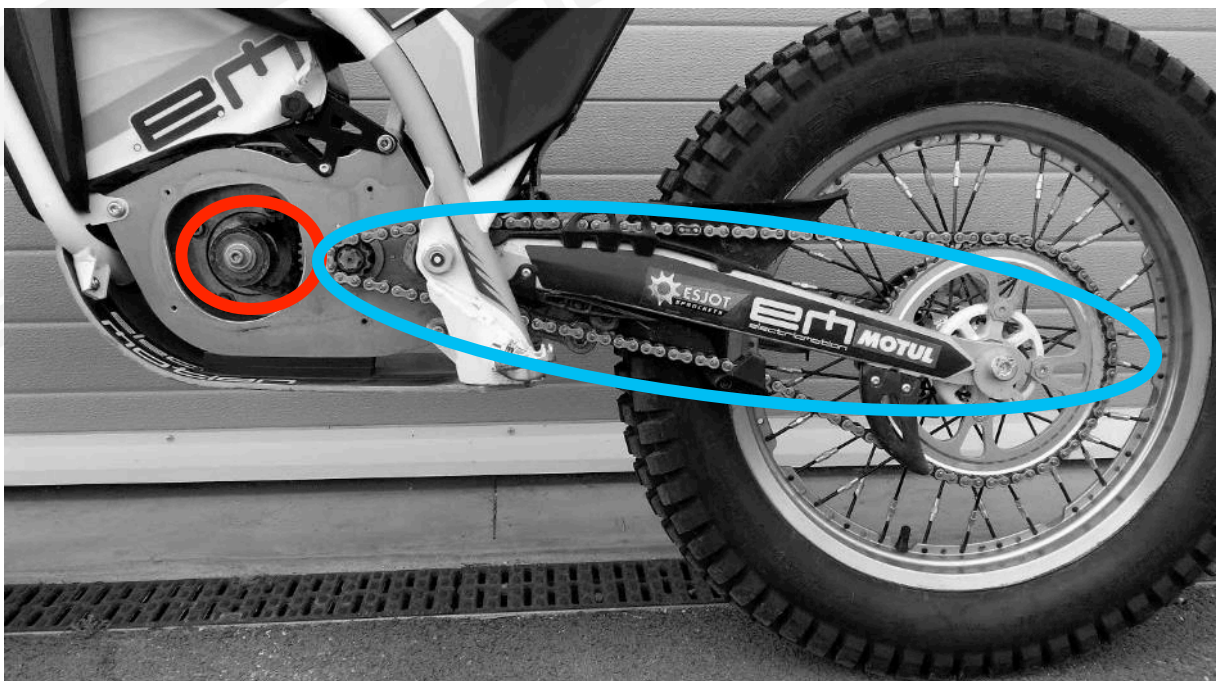



4.2.1. PRIMARY TRANSMISSION

It is necessary to regularly check the state of the primary transmission. This transmission is located between the two transmission plates, under the battery pack.



Please, follow the next procedure:

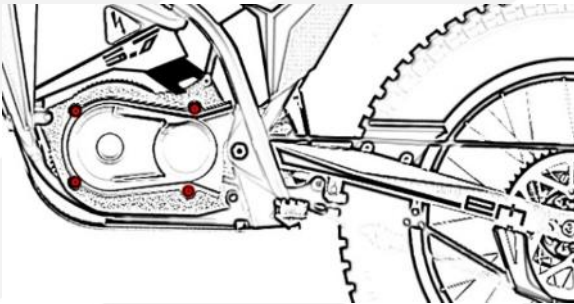

- Unscrew the 4 transmission carter screws

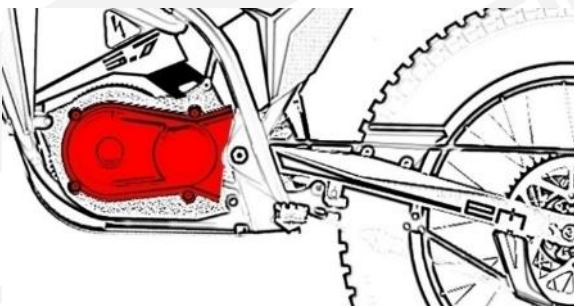

- Remove the transmission carter

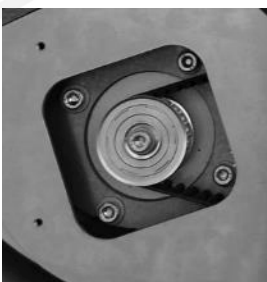

- Check the state of the transmission
- Check the belt
- Once the checking is done, reassemble the transmission carter with its 4 screws



4.2.2. SECONDARY TRANSMISSION

The secondary transmission needs to be cleaned and lubricated after every riding session

CHAIN TENSION:

Please follow the next procedure to check or adjust the secondary chain tension.
Attention: To do this operation, the motorcycle needs to be on the floor.

- 1) LOOSEN the rear wheel axle.
- 2) ADJUST the chain tension with the setting cranks on each side of the swingarm. The crank position needs to be the same on the 2 sides.
- 3) ADJUST the tension following the next picture.

- 4) When the tension of the rear wheel is OK, TIGHTEN the rear wheel axle.

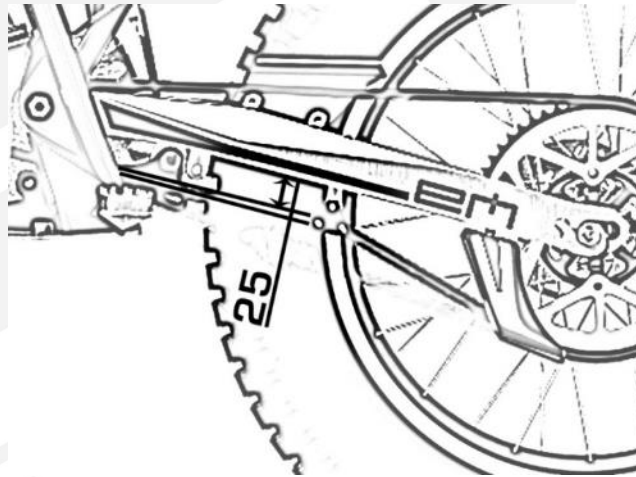

CHAIN LUBRIFICATION:

Electric Motion recommend MOTUL for the maintenance of your bike



- ✓ Clean the chain with MOTUL's products and a cloth
- ✓ Afeter cleaning, use MOTUL lubrifiant



After reading this document, you can ride your EM.

Take the time to adapt your riding to the motorcycle behavior. I will allow you to ride this motorcycle in the best conditions to discover all its capacities!

If you have any question or any doubt, please contact us by phone or email

0033 467 411 090

emotion.sav@gmail.com

Electric Motion's team wishes you to enjoy riding your electric motorcycle.