

EM

ELECTRIC MOTION

EPURE RANGE



INFORMATION

ELECTRIC MOTION
ZAC VIA DOMITIA
280 Rue du Trident
34740 VENDARGUES
FRANCE



+33 467 411 090



www.electric-motion.fr



Projet cofinancé par le Fonds Européen de Développement Régional

emotion.sav@gmail.com

manon.zorzi@electric-motion.fr

info@electric-motion.fr



These information are not contractual and can be changed without any notice.

Table of contents

1. 1. Manual introduction	5	3.8 Parts and consumables.....	12
1.1 Important message from <i>Electric Motion</i>	5	3.9 Operation under extreme conditions.....	12
1.2 About this manual	6	3.10 Reception of the motorcycle	12
2. Safety instructions	7	4. Vehicle identification	13
2.1 Regulatory use	7	4.1 Chassis number	13
2.2 Operating information	7	4.2 European certification label	13
2.3 Protective clothing	8	4.3 Engine number (references).....	13
2.4 Environment.....	8	4.4 Battery number (references).....	13
2.5 Location of important labels	9	5. Overall view of the vehicle	14
2.6 Fire hazard.....	9	5.1 Right view	14
2.7 Fall or accident	9	5.2 Left view	14
3. Important observations and general information.....	10	6. Technical data	15
3.1 Emission information	10	6.1 Engine.....	15
3.2 Manufacturer's warranty and legal warranty	10	6.2 Tires.....	15
3.3 Vehicle range.....	10	6.3 Fork	15
3.4 Transport of the vehicle	11	6.4 Shock absorber	15
3.5 Spare parts and accessories	11	7. Controls and Components.....	16
3.6 Lifetime optimization	11	7.1 Front/rear brake system and adjustment	16
3.7 Power supply.....	12	7.2 Throttle grip	16
		7.3 Lighting system.....	17

7.4 Turn signals	18	9.9 Motorcycle storage	36
7.5 Left-hand side handlebars switches	19	10. Setting the motorcycle controls	37
7.6 Main magnet switch and map button	19		
7.7 Side stand	20		
7.8 Vue d'ensemble du tableau de bord	20		
7.9 Battery pack	21		
7.10 Battery charger	24		
8. Commissioning	25		
8.1 Preparation on receipt of the motorcycle in a shipping box	25		
8.2 Instructions for initial commissioning	26		
8. Battery Charging Procedure	27		
9. Operating the motorcycle	30		
9.1 Inspection before use	30		
9.2 Starting the motorcycle	31		
9.3 Motor's behavior adjustment	32		
9.4 Braking	33		
9.5 PRB & PELS (option)	33		
9.6 Clutch (RACE model)	34		
9.7 Stopping your motorcycle	35		
9.8 Cleaning the motorcycle	35		

1. 1. Manual introduction

1.1 Important message from *Electric Motion*

Congratulation and thank you for purchasing *Electric Motion* Epure electric motorcycle. We welcome you in our family devoted to electrons.

Electrical production on national grids becoming more and more clean and renewable, we are proud to provide you with an alternative to internal combustion engines and therefore allowing you to take part in solving the serious challenges we all face with air pollution and global warming.

The use of this electric motorcycle requires you to respect some recommendations and precautions in order to enjoy all the advantage that can offer this new clean alternative.

It is therefore imperative to read this manual which contains all the necessary information for preparing for the motorcycle first use, on how to operate it, on how to maintain the motorcycle and on what checks need to be carried. Furthermore, this manual contains all the information to prevent yourself and third parties from risks and accidents linked to the use of an electric motorcycle.

Because the *Electric Motion* team is continuously improving their products, it is possible that some information contained in this manual might change due to updates. If you have any doubt, do not hesitate to check our website www.electric-motion.fr and [download the latest version of the manual. Thus, no juridical claim can be carried out based on the information contained in this manual.](#)

The content of this manual will allow you to maintain your bike in perfect working order in the most secure way possible.

1.2 About this manual

This manual only includes all the operating and maintenance information for the Epure model of the *Electric Motion* brand. Under no circumstances should these instructions be used for the maintenance of other models of the brand.

Keep the user manual in an easily accessible location, so that it is close to hand when required.

The "right" and "left" designations refer respectively to the right or the left of the rider when he is in the driving position.

To illustrate all the maintenance operations, or to clearly designate elements of the motorcycle, pictures were used. Since *Electric Motion* is constantly improving their product, it is possible that certain parts of the motorcycle will change in geometry or in colors. However, this does not affect the operational processes explained in the manual.

The owner's manual is an important part of the vehicle. It must be transferred from owner to owner upon resale of the vehicle.



In this manual, the **CAUTION** designation will alert you to an object or situation that may cause injury to you or a third party or also damage your vehicle.

2. Safety instructions

2.1 Regulatory use

The *Electric Motion* Epure has been designed and built to withstand mechanical stress resulting from road and off-road use.

The Epure model has been assembled in order to be homologated and thus has all the equipment necessary to be ridden on roads opened to traffic. It is therefore forbidden to modify the accessories installed as standard on the motorcycle. *Electric Motion* cannot be held liable for any modifications to the accessories installed on the motorcycle.



Use only *Electric Motion* parts. These parts have been tested and approved by *Electric Motion*. Under no circumstances should you try to replace the motorcycle components such as the battery pack or the engine with components of another brand, at the risk of causing irreversible damages to your vehicle.

Electric Motion does not assume any responsibility for the adaptation of unapproved parts.

2.2 Operating information

In order to guarantee a safe operation of the motorcycle, it is forbidden to carry out any modification on the vehicle.

For example, it is formally prohibited to use the vehicle if the vehicle, or one of its components, hasn't been properly maintained or if it is used outside the scope of the intended use. It is also forbidden to open the motor or the battery pack.



Any modification carried out on the vehicle by the customer does not render *Electric Motion* liable and voids any form of manufacturer's warranty.



Do not use the vehicle under the influence of alcohol, any medicine that could alter your capacity to drive or illegal drugs, or if you are not physically or mentally able to drive.



When using the vehicle, some components will start moving (chain, wheels) and will become dangerous for the user. It is important to take the right measures to avoid any unnecessary risks.

2.3 Protective clothing

To reduce the risks of potential injury while riding an Epure motorcycle, on road or off road, it is necessary to be equipped with all compulsory protective clothing.

For any kind of trip and for any person that will ride the motorcycle, it is necessary to wear the correct protective clothing (helmet, boots, gloves, trousers and jacket equipped with protective means).



Failure to wear safety clothing or wearing damaged safety clothing is a serious safety hazard and can result in serious injury or death.

Like the driver, the passenger must also carry all the necessary protective clothing when riding the motorcycle behind the driver.



Only use protective clothing that is in perfect condition and complies with the legal requirements of the country of use.

2.4 Environment

In order to guarantee the durability of motorcycle driving, it is necessary to respect the rules of goodwill on the road with other users, motorized or not. Ensure that you remain within the legal framework of the use of a motorcycle. Be respectful to the environment and road users and take into account the rights of other road users.

When the motorcycle parts are disposed of, be sure to comply with the recycling regulations of the country of use, in particular the battery pack.



Electrical components (motor, battery, etc.) and electrical appliances (battery charger) should not be treated as household waste and require strict recycling.

If you have any questions about the rules for recycling, contact *Electric Motion* Customer Service.

2.5 Location of important labels

Safety instructions are present in various places on the motorcycle. They allow the user to protect himself from certain risks associated with the maintenance of the motorcycle and to preserve the physical integrity of the motorcycle, its driver and its passenger.

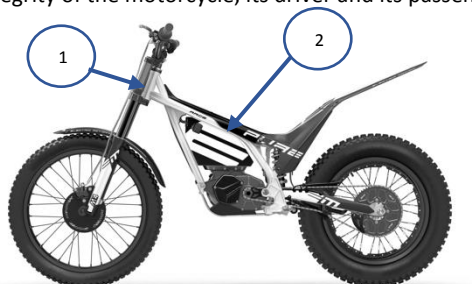

1	Manufacturer label
2	Warning label

Never remove the warning labels. They allow the driver to avoid getting injured by exposing himself to a danger that cannot be recognized without the presence of these stickers.

2.6 Fire hazard

As long as the battery pack remains in good working condition, there is no particular fire hazard on this vehicle. However, if the vehicle catches fire, it is necessary to inform the fire brigade that the fire originated from an electric vehicle with a lithium-ion battery.

When the battery pack is damaged, it may present a fire hazard.

If the battery pack is damaged, contact *Electric Motion* customer service promptly.

2.7 Fall or accident

A fall or a road accident can damage the motorcycle significantly. After a fall or an accident, make a complete inspection of the vehicle to make sure that the users of the motorcycle do not expose themselves to any danger before riding again.

A vehicle damaged for any reason may become a danger to users. In case of damage to the electrical components, please contact the *Electric Motion* customer service promptly.

3. Important observations and general information

3.1 Emission information

The development of the Epure by *Electric Motion* has made it possible to obtain a zero emission motorcycle that does not emit any harmful particles for the environment. Therefore, it has no exhaust or evaporative emission.

This motorcycle does not use gasoline, engine oil or any other liquid fuel.

3.2 Manufacturer's warranty and legal warranty

All the work detailed in the maintenance guide must be carried out exclusively by a professional in order to retain the warranty right.

The warranty is cancelled in the event of damages resulting from manipulation or modification on the vehicle made by a person not certified by *Electric Motion*.

For additional information on the manufacturer's warranty and how to obtain it, contact *Electric Motion* customer service.

3.3 Vehicle range

The Epure range is defined as the distance the vehicle travels on a single full charge of the battery.

It is then easy to understand that the range of the vehicle depends on how it is used. The more conservative you ride, the better range you can expect from your motorcycle.

There are many factors affecting the range, such as speed, acceleration, number of regenerative braking, weather conditions, tire pressure and payload.

For the first use of your Epure, you are advised to remain cautious so you become fully aware of the range of your vehicle according to your driving style.

After you were able to make your own idea about the potential of the Epure model, you can adapt your driving style to the range you would like to achieve.



The range values in this manual are measured according to different standards, which may vary depending on the country of use.

In order to improve the range of your vehicle, all these characteristics must be considered:

Low range	Important range
Travelling at high speed	Low speed travel
Bad road condition	Good road condition
Important elevation	Low elevation
Aggressive driving	Smooth driving
Important payload	Low payload
Cold temperature	Hot temperature
Adverse weather conditions	Good weather conditions
Under inflated tires	Properly inflated tires
Poor general maintenance of the motorcycle	Good general maintenance of the motorcycle

3.4 Transport of the vehicle

The transport of the motorcycle can be carried out with the help of an approved trailer or a utility vehicle.

It is important to ensure that the motorcycle is securely fastened before transporting it on the public road. The use of certified straps to maintain the motorcycle is recommended to avoid any accidents related to the loss of the vehicle on public roads.

3.5 Spare parts and accessories

For safety reasons, we recommend that users of Epure only use spare parts and accessories authorized and recommended by *Electric-Motion* and have them fitted by a professional.

The company *Electric Motion* will decline any responsibility in case of equipment deterioration caused by products not approved by the brand.

For information on spare parts and their installation, contact the *Electric Motion* customer service or on our website www.electric-motion.fr.

3.6 Lifetime optimization

In order to optimize the life of the vehicle, it is important to perform the maintenance tasks listed in the user manual at the right mileage/time of use.

Maintaining maintenance intervals is important to keep a vehicle in good working condition and to avoid early wear.

What's more, incorrect adjustments of the chassis results in premature wear of the vehicle.

It is important to refer to the vehicle maintenance manual.

3.7 Power supply

Model	Epure Lite	Epure Sport	Epure Race	Epure Escape
Voltage	Min: 42V / Nom: 50.4V / Max : ≈58V			

It's possible to mount / dismount the battery pack during some maintenance process. (🔧 16.1).

3.8 Parts and consumables

To maintain your vehicle, it is important to use parts and consumables (lubricants and maintenance products) in accordance with the specifications given in the user manual.

3.9 Operation under extreme conditions

The Epure is not sensitive to water and rain. However, care must be taken to ensure that the water level on the road being ridden does not exceed the foot-rest height.



In the event the rider is stopped on a road with a high level of water, it is necessary to turn off the motorcycle to avoid a short circuit or a breakdown.

The Epure can be used over a wide range of temperatures: -15°C to +55°C (5°F to 131°F).



The battery life of the Epure model depends on the operating temperature:

Operating temperature (°C)	-15°C (5°F)	-10°C (14°F)	0°C (32°F)	25°C (77°F)	40°C (104°F)	55°C (131°F)
Decrease in battery range	-30%	-25%	-15%	-0%	-3%	-4%



Use of the vehicle in extreme conditions (sand, mud) leads to premature wear of the motorcycle's consumables (chain, brake pads, various bearings). It is then necessary to carry out the checks and the maintenance operations more often than prescribed in the manual of use.

3.10 Reception of the motorcycle

When receiving the Epure model, it is necessary to perform some operations to make the motorcycle usable (assembly of parts protected during transport). Please refer to the corresponding chapter (🔧 8).

4. Vehicle identification

4.1 Chassis number

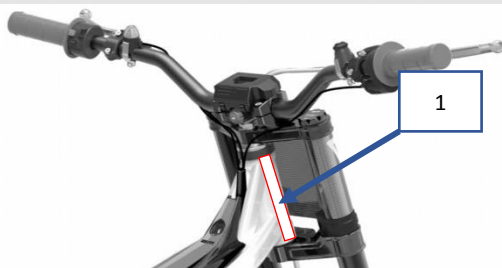

4.2 European certification label



4.3 Engine number (references)

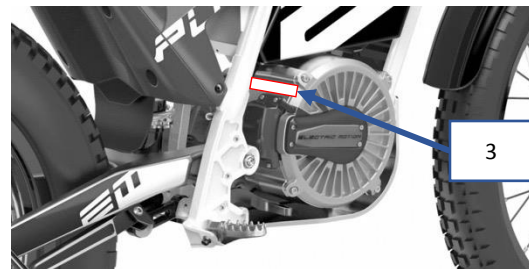

4.4 Battery number (references)

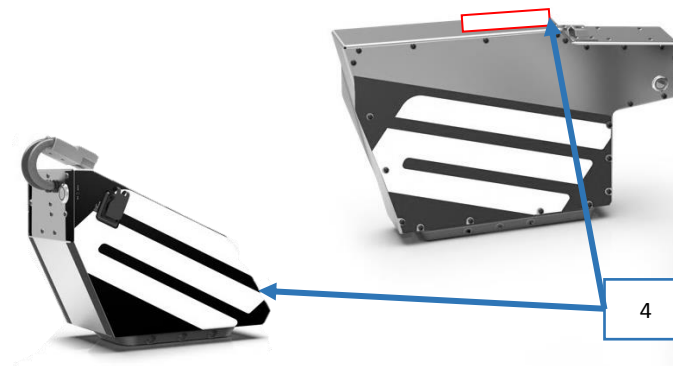

5. Overall view of the vehicle

5.1 Right view



5.2 Left view



6. Technical data

6.1 Engine

Motor type	BLDC permanent magnet motor
Nominal power	6 kW
Peak power	11 kW
Maximal torque	600 N.m
Engine max speed	6500 RPM
Cooling system	Air

6.2 Tires

Model	Epure Lite	Epure Sport	Epure Race	Epure Escape
Tyres	MICHELIN X11			

6.3 Fork

EPURE Lite / ESCAPE :

TECH Steel \varnothing 39 mm

EPURE Sport / EPURE Race :

M4 Aluminium Air \varnothing 39 mm

6.4 Shock absorber

Model	Epure Lite	Epure Sport	Epure Race	Epure Escape
Rear	R 16 V			

7. Controls and Components

7.1 Front/rear brake system and adjustment

The front brake lever is located on the handlebars right-hand side.
The rear brake pedal is located near to the right foot peg.



 Before each use, check the condition of the brake system. A faulty brake system makes you vulnerable as well as the other road users.

7.2 Throttle grip

The throttle grip is located on the handlebars right-hand side.

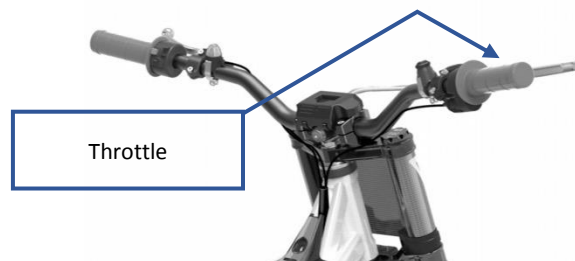

 Before each use, check that the throttle grip rotates and returns correctly to prevent any accident.

7.3 Lighting system

The headlight is installed on the forks located on the vehicle front and the taillight is installed on the rear subframe of the vehicle. *Electric Motion* advises to always have the lights turned on.

Headlight:



 The headlight can get hot when it is turned on.

Taillight:



 Make sure that the lighting system is always in working order. Riding without a lighting system does not allow other users to see you and does not allow you to see other users. It is mandatory to have a lighting system in good working order.

7.4 Turn signals

Front turn signals:



Rear turn signals:

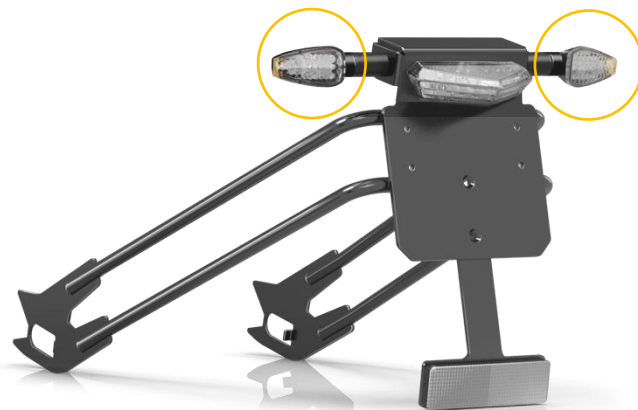

7.5 Left-hand side handlebars switches

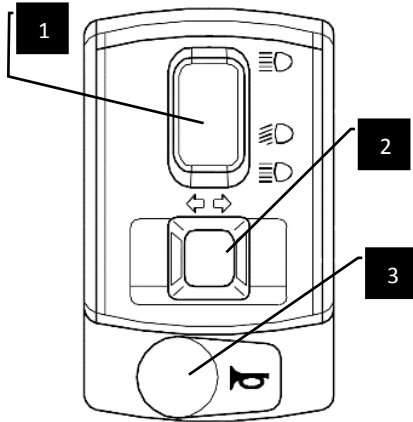

On the left side of the handlebar, the main magnet switch is lighting when the bike is ON and when the battery is ON



When you switch OFF the battery, this red LED will be OFF
The total extinction of this led can take some minutes, but the battery is well shut.

7.6 Main magnet switch and map button



On the left side of the handlebar, the magnet switch is needed to switch ON the motorcycle.
 When the magnet is installed, the motorcycle is ON.

Cluster switch ON.

Now you just have to push the map button to select the map needed.

7.7 Side stand



7.8 Vue d'ensemble du tableau de bord

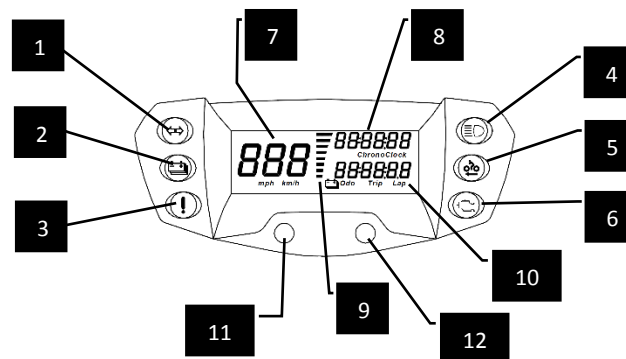

1	Right and left turn signals indicator
2	Low battery Indicator
3	High temperature indicator
4	Headlight high beam Indicator
5	"Ready to ride" Indicator
6	System warning indicator
7	Speed (km/h à mph : 10sec on MODE button)
8	Battery charge indicator
9	Total motorcycle mileage or trip odometer
10	Select button
11	Adjust button (MODE)
12	Battery charge indicator (SET)

7.9 Battery pack



Epure Battery

Escape Battery

The battery is inside the battery pack. The casing of the battery pack makes it possible to protect all the cells composing the battery against the aggressions of the external environment. Up to a certain limit, the battery pack is protected against splashes of water, dust and other harmful elements for the battery (rain, driving in dry weather). However, the user must be careful not to use the Epure motorcycle under extreme conditions, otherwise the vehicle may be damaged irreversibly (full immersion of the motorcycle).

The battery pack uses a set of lithium-ion cells assembled in series. These elements have been tested to obtain the best performance while maintaining maximum reliability.

It is important to note that the maximum capacity of the battery will be obtained after **about 10 cycles of full charge / discharge of the vehicle.**



The battery pack is dimensioned to achieve the best possible reliability / performance ratio. It is possible, however, that certain maintenance operations will be carried during the lifetime of the vehicle.

All work on the electric components of the motorcycle, and especially on the battery pack, is accompanied with risks of causing electric arcs if precautions are not taken. Working on the electric components of the motorcycle requires special training, qualifications and tools.

Therefore, all work that is not explicitly described in this manual, and which concerns an electronic device, must be carried out only by an *Electric Motion* qualified electrician.

Do not open the motor or the vehicle battery pack. If there are any problems with these items, contact *Electric Motion* Customer Service.



When receiving the motorcycle, it is important to charge the battery pack according to the recommended battery charging procedure.



Be sure to turn off the motorcycle after each use or whenever the motorcycle is not used for a long period of time. Make sure that all the lights are turned off when the ignition key is switched off.

Battery management system (BMS)

The BMS (battery management system) is an internal component of the battery pack. It allows the management and the control of all the battery cells during charging and discharging of the vehicle. The BMS therefore protects the battery with the help of an electric safety relay.

The main roles of the BMS are therefore:

- Prevent the charge of the battery when the outside temperature is below 0°C (50°F).
- Prevent the charge of the battery when the outside temperature is above 45°C (113°F).
- Prevent the discharge of the battery when the outside temperature is below -15°C (5°F).
- Prevent the discharge of the battery when the outside temperature is above 55°C (131°F).
- Allow a uniformly distributed charge of all cells in the battery pack.
- Optimize charging and discharging of the battery.



The BMS is a vital component of the motorcycle for its good working order. Do not try to modify it by any means.

Battery charge level

The battery pack is connected to the dashboard and therefore allows the display of the state of charge directly on the dashboard.

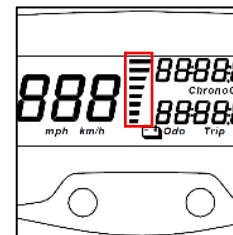

The battery charge indicator is composed of 8 bars indicating the range of the motorcycle.

As you approach the last bar, the low battery indicator LED lights up indicating that you reached a low battery charge level:

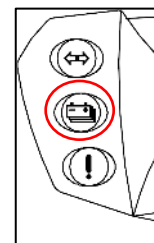

 When this indicator light turns on, the battery is in low voltage, which means that the motorcycle can cut off in order to prevent any damages to the cells. **It is important to avoid excessive speeds and abrupt accelerations when the low battery indicator lights up and to reach a charging station as fast as possible.**

 If you plan on using any highway and depending on the battery charge left and the distance left to travel, check first that there is a charging station on your way or that there is a highway exit, so you don't get stranded.

An option exists where the battery level indicator is located on the center of the handlebar (option OFF ROAD KIT).

Battery level indicator OFF ROAD version (hors UE)



The battery level indicator goes in sleep mode after 10 second, to display again the battery percentage level, you have to push the main button located directly on the center of the display.

To have a precise value of the battery percentage, it's necessary to do not ride with the bike for almost 1 minute (bike still ON), and then push the main battery level button to see the percentage.

It's possible that the display switch it on during ride, do not take care of the displayed value.

 Not any high pressure washing on this display.

It is important to avoid excessive speeds and abrupt accelerations when the battery level is under 20% and to reach a charging station as fast as possible.

7.10 Battery charger

The Epure model can be delivered with 3 different types of battery chargers with different charge speeds: a 10A charger, a 15A charger and a 25A charger.

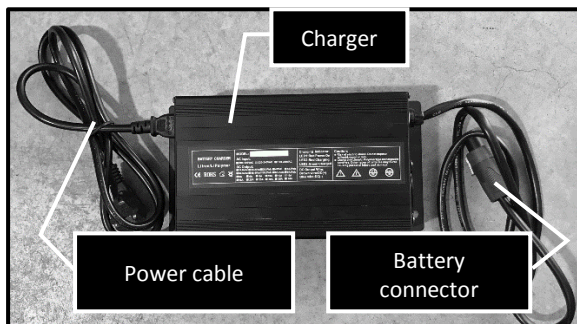

 In a wet environment, there is a risk of creating electric arcs when charging the vehicle. The battery charger is not humidity-proof. It is important to use the battery charger in a dry environment and to ensure that no liquid are spilled on the charger.

 In case of incorrect handling of the battery charger, the safety of the user is not guaranteed.

 Use the battery charger only with an *Electric Motion* battery pack. Use the battery charger only by connecting it to a safe electric socket in accordance with the regulations in force in the country of use. Do not use an adapter or extension cord other than the one already presents on the charger.

 Do not modify the battery components by any means. Check that the charger's power cable and battery cable are in good condition before each use.

8. Commissioning

8.1 Preparation on receipt of the motorcycle in a shipping box

On receipt of the vehicle, the handlebar is disassembled. It is therefore necessary to assemble all these components in order to use the motorcycle.

Assembling the handlebars upon receipt

The handlebars are supplied in the box accompanying the motorcycle and must be assembled in accordance with the following procedure:

- Unscrew the 4 M8 screw of the upper handlebar holder and remove them.
- Install the handlebar like the picture below.



- Install the again the handlebar holder and the 4 M8 screw with a 6mm Allen key, tightening them at 20 Nm and taking care of the position of the handlebar.



- Take care of the wires during mounting.

8.2 Instructions for initial commissioning

Before using the motorcycle, the user must carefully read the entire user manual.

Because driving an electric motorcycle is a new driving experience, a period of adaptation is necessary to become familiar with the new sensations that it brings before being fully confident when traveling on roads open to others traffic users.

Before using the motorcycle on the road, ride it in a secure area to get acquainted with riding an electric motorcycle. Try all settings on the vehicle and get familiar with the results.

To maintain control of your vehicle, always hold the handlebars with both hands and keep your feet on the footpegs.



Do not use the vehicle if you are not in full possession of your means.

Adapt a cautious behavior for you and other road users.

Do not exceed the vehicle's permissible payload.

Do not leave your vehicle unattended (risk of theft).



An electric motorcycle makes no noise when it is turned on, do not let yourself be caught by surprise.



When the battery level is low, the motorcycle keeps working on an energy saving mode. The vehicle power is reduced but it is in

no way a breakdown. After charging the battery, full power will be available again.



When the battery has been over discharged, the motorcycle will not start charging straight away. It is necessary to wait until the vehicle automatically start charging again.

8. Battery Charging Procedure

The procedure for charging the vehicle being meticulous, it is important to be familiar with this procedure before the first charge of the battery.

The battery must be charged over a temperature range from 0°C to 40°C.



Due to the strong current involved, electrical arcs may occur when connecting the connector to the battery.

Use only the charger supplied with the motorcycle to charge the battery. This charger is designed to operate only with a lithium polymer battery.

Always place the charger on a flat, solid surface in a dry, ventilated area.

Never cover the charger while charging the battery, otherwise it may interfere with its ventilation and cause the charger to overheat.

Charging Procedure for 10A, 15A and 25A chargers

- Stop and switch off the motorcycle (👉 9.5).

- Plug the charger on the wall plug.



- Only for 25A charger, switch on the switch located on the back of the charger.
- Verify that the LED 1 & 2 are like the below picture :



- Plug the charger to the battery
Epure

Escape



Left side

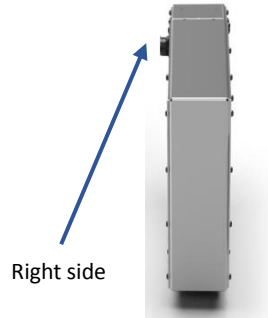

Right side

 When the connector is inserted in the battery, a “click” can be heard indicating that the battery has switched to a charging mode. The battery will then start charging automatically. When switching to charging mode, both charger’s LEDs will be red.



- When the charge is finished, the LED2 will go to Green like the below picture.



To connect the charger to the battery:

- Slide the connector

THEN

- Turn the connector to the right

- Disconnect the charger from the battery.

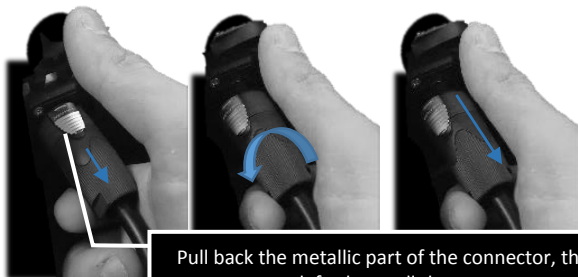

Pull back the metallic part of the connector, then turn to left, then pull the connector

- Only on 25A charger, switch of the switch located on the back side
- Unplug the charger from the wall plug.



Remarque : En cas de problème pendant la charge, veuillez répéter le processus de chargement **depuis le début** pour remettre la batterie en charge.



When the motorcycle is charging, do not turn on the motorcycle using the ignition key, it would immediately stop the charging process.



Regardless of the charger used, do not leave the battery charging for too long, otherwise damage may occur. If the battery has a failure, the charger's LED n°2 will not be red but green indicating that the battery is not charging. This may be due to a damaged battery. It is therefore essential to contact a professional certified by *Electric Motion*.



Take care to do not put any metal object inside the battery charge plug on the battery.



Take care that the battery charge plug is not filled of water.



Do not leave the charger connected to the battery after charge.

9. Operating the motorcycle

9.1 Inspection before use

It is important that the user of the Etrek motorcycle checks that the condition of the vehicle is intact and that it can be safely used before each journey.

In order to be used, the motorcycle must be in perfect technical condition.

The pre-ride inspection consists of:

- Check the state of charge of the battery.
- Check that all the screws and bolts are tight.
- Check for correct function of all the electrical equipment.
- Check that the brake system is in proper condition (brake fluid, brake pad wear and system operation).
- Check the condition and pressure of the tires.
- Check the condition of the final drive system (chain and sprocket, lubrication).
- Check for correct function of all the control devices.



If there are any abnormalities on the motorcycle during the pre-trip inspection, do not take any risk, contact *Electric Motion* customer service

9.2 Starting the motorcycle

- Switch on the battery by pushing main switch

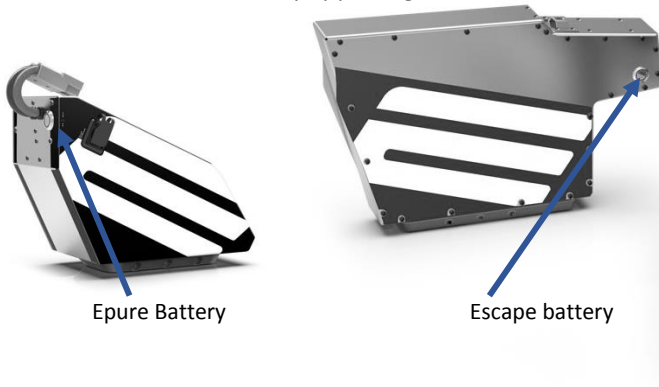

- Install the magnet on the base.



- The motorcycle is now ON, in security map.

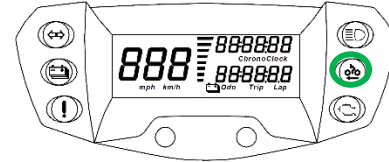

- Then push the map button to be in the first map and change then as desired with map button.



- The Bike is now ready to ride.

The motorcycle should be at a complete stop before turning it on.

When the bike is in working order, it does not make any noise!

Under no circumstances should the kickstand be unfolded when the motorcycle is used.

9.3 Motor's behavior adjustment

The motorcycle is equipped with 3 driving maps which you can select by the map button.

PUSH - MAP 0 (WHITE LED)

The Map 0 is a security map, you have to push the map button to select the Map 1

ESCAPE /

1 – TREK (GREEN LED)

Trek mode is dedicated to Trek use, acceleration is smooth up to the max speed

2 - TRIAL 1 (BLUE LED)

TRIAL 1 map is dedicated to wet condition, acceleration is smooth up to max speed.

3 - TRIAL 2 (RED LED)

TRIAL 2 map is dedicated to trial use, in dry condition and 100% of the performance of the motorcycle.

EPURE Lite, Sport, Race /

1 - TRIAL 1 (GREEN LED)

TRIAL 1 map is dedicated to hard conditions and where traction is needed. Acceleration is smooth up to max speed.

2 - TRIAL 2 (BLUE LED)

TRIAL 2 map is dedicated to dry trial use, more powerful and more response for trial use.

3 - TRIAL 3 (RED LED)

TRIAL 3 map is the most powerful map of the motorcycle with 100% of the performance.



Driving too fast or aggressive can cause overheating problems.



Make sure you are aware of the motorcycle different behaviors when changing maps before using them in traffic/open roads. These changes in behavior could surprise an uninformed driver.

9.4 Braking

The front brake lever, located on the right hand side of the handlebars, brakes only the front wheel.

The rear brake lever located near to the right footpeg brake the rear wheel.

The brake levers control the brakes when the lever is squeezed.

It is important to be fully aware of the motorcycle's braking capacities for safe driving on public roads.

To brake properly, under normal traffic conditions, first close the throttle. Then brake using simultaneously the front and rear brake levers for strong braking.



When braking, the throttle grip must be in the closed position (acceleration stopped).



Braking too strongly causes the wheels to lock and makes the motorcycle dangerously uncontrollable. It is necessary to adapt your braking to the situation and to the pavement condition.



Check the condition of the brake system before each use. A wet or dirty brake system greatly reduces braking performance. Clean and degrease the system if grease or dirt is present.

If there is any doubt about the condition of the brake system, contact *Electric Motion* customer service.

9.5 PRB & PELS (option)

To be perfectly adapted to trial driving, the EM trial has a PELS (Progressive Electronic Lever Switch).

The PELS system (Electric Lever Switch) allows you to cut or liberate, in a progressive manner, the motor's power, such as a heat motorcycle can. It is very useful to cross obstacles for example.



But this lever can also be used as PRB (Progressive Regenerator Brake). When the pilot is not accelerating, the motor is not powered. If it is in freewheel, it is possible to regenerate the motor ;it allows to recharge the battery while acting as a motor brake. Therefore, this lever allows to manage the regeneration percentage.

Shift PELS – PRB :

To use the lever in PELS or PRB mode depending on what you want, you need :

- Remove the cover
- Remove the “shunt” connector corresponding to the mode you want to use (sticker « PELS » or « PRB »), with a thin tool
- Unplug the plug which is connected, and plug the one you want.
- Don't forget to reconnect the “shunt connector” on the plug which is not used
-

Sticker on the harness



Shunt should be installed on the non-used

9.6 Clutch (RACE model)

The RACE model is equipped with multi-dic clutch with hydraulic command who allow to uncouple the motor from the transmission.

It can be very useful for trial, but it can be dangerous for amateur rider.

When the lever is released suddenly, the motorcycle will be very aggressive and dangerous.



9.7 Stopping your motorcycle

To turn off the vehicle, follow the procedure below:

- Remove the magnet switch from his support.
- Switch off the battery (the LED around the battery switch ignition will goes to OFF).
- Unfold the kickstand so it is down and lean the motorcycle on it. Make sure that the motorcycle is stable and on a hard and stable ground to avoid falling. Beware of where you park your motorcycle and if there is a slope or not, the motorcycle having no gear to stop it moving.



Do not leave your motorcycle unattended after use. After riding, some parts of the motorcycle may be hot, so be sure not to touch them before they are fully cooled to avoid any risk of burns.

9.8 Cleaning the motorcycle

The motorcycle must be cleaned with clear water. It is possible to use soap to clean it.

To clean your motorcycle it is necessary to:

- Wash the motorcycle without insisting on the components vulnerable to moisture (electrical components, external controls and external bearings).
- Rinse the motorcycle thoroughly with clean water.
- Dry the motorcycle, insisting on the electrical contacts.



Do not clean the handlebars directly with a high pressure washer.



Take care that the charge battery cap is well install on the charge connector on the battery.



DO NOT CLEAN THE MOTOR SENSOR WITH HIGH PRESSURE WASHER.



DO NOT CLEAN THE BATTERY WITH HIGH PRESSURE WASHER.



DO NOT CLEAN THE CONTROLLER WITH HIGH PRESSURE WASHER.

9.9 Motorcycle storage

In case of long-term storage of the vehicle, it is important to apply additional measures.

It is necessary to:

- Clean the motorcycle correctly (👉 9.6).
- Raise the motorcycle using a bike stool or dirt bike lift stand (allowing the suspensions of the vehicle to be relieved) (👉 12.1).
- Park your vehicle in a dry place, where the temperature is between 10°C and 25°C, which is not subjected to excessive temperature variation and protected from UV radiation.
- Cover the motorcycle with a breathable cover.

When storing your motorcycle, it is important to follow a strict procedure to protect the battery during storage.

When storing the motorcycle for longer than one month

Store the battery with a charge level indicator as shown in the picture below.

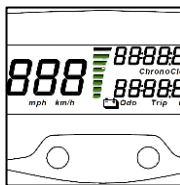

Place the battery pack in an environment not exposed to direct sunlight and at temperatures below 25 ° C.

Recharge the battery every month if not in use.

Note: There is no special precaution to be taken to restart the motorcycle.

Note: After long storage, the battery will be in deep sleep, to switch ON again the battery, you have to make several ON/OFF ignitions to wake up the battery



The battery charge level should be checked monthly, recharge the battery if necessary with the supplied charger.



If the motorcycle does not start after the storage period, do not attempt to recharge the battery and contact *Electric Motion* Customer Service immediately.



Make almost 2 discharge/charge per year.

10. Setting the motorcycle controls

It is important to find your place on the motorcycle before starting to drive. Being at ease on your vehicle makes it possible to travel safely on public roads and to have a fluid riding style.

To adjust your Epure motorcycle at your convenience, adjust the position of the motorcycle levers, mirrors and handlebar position according to the following procedures:

Levers position adjustments

- The levers can be adjusted using a 5mm Allen key. Tightening torque of 8Nm.



- For the lever positioning, you have to adjust these 2 screws.

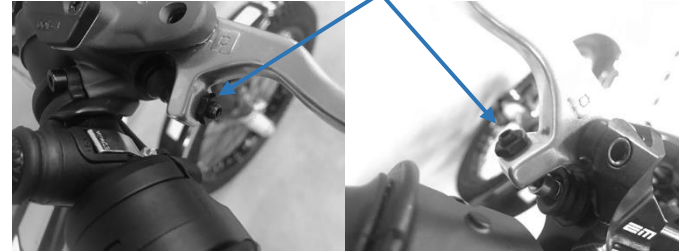

We recommend to do not change the lever stroke.



Take care to frequently check your lever tightening.

Mirrors position adjustments

- Tighten the mirror with a 13mm tool





Handlebars position adjustments

The handlebars can be adjusted by untightening the 4 screws holding the handlebars on the bar mounts.

- Loosen the 4 screws with 6mm Allen.
- Adjust the Handlebar.
- Tighten the 4 screws evenly at 20Nm



 Please, frequently check that the screws holding the handlebars on the bar mounts are tight.

 Please, make sure that the handlebars are centered on the bar mounts.

11. Maintenance

11.1 Front fork dismounting – mounting

Dismounting

- Stop the motorcycle (👉 9.5).
- Install the motorcycle on a stand (👉 12.1).
- Remove the front plate (👉 11.1).
- Remove the front mudguard (👉 15.1).
- Dismount the front brake caliper with a 5mm Allen key.
- Unscrew the upper and lower clamp with 4mm Allen key
- Slide the fork to remove it from the clamp

Mounting

- Slide the fork inside the clamp one by one
- Adjust the position on the fork with the distance / mark on the upper (second mark is the standard position) ²

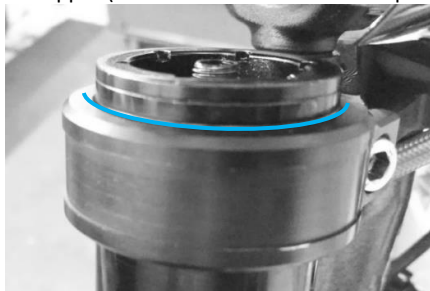

- Screw the M6 screws of the clamp at 11 Nm



- Install the front caliper with the M8 screws and a 5mm Allen key, tightening at 10 Nm
- Install the front wheel, the front wheel axle, and tight the 40 N.m.



- Use the fork slowly (3-4 times) to adjust the fork
- Tight the screw under the right fork at 6N.m.
- Mount the front mudguard and his support. It should be mounted without any constraints, and tight it at 8Nm.



Take care to test the performances of the front brake before riding, it's possible that during mounting the front caliper piston should be not ready to brake directly, make some braking with the handlebar lever.

11.2 Clean the fork

It's necessary to clean the fork after each use, to avoid any damaged seal.

- Stop the motorcycle (👉 9.5).
- Put the motorcycle on a stand (wheels in air) (👉 12.1).
- Lubricate the dust seal protectors,
- Clean the fork tube with clean cloth and install grease.
- Remove the excess of grease.



Absolut forbidden, all aggressive products.



Do not use high pressure water jet directly on the seal.

11.4 Maintenance

	Cleaning	Complete maintenance
Amateur pilot	After each ride	100 hours or 1 year
Pilot		40 hours

11.5 Niveau d'huile

The quantity of oil in the fork is:

- 60ml RIGHT
- 40ml LEFT



It is **IMPORTANT** to know that this oil is replaced by the lower part of the sleeve and that the unscrewing is done in a clockwise direction.

For assembly, proceed in reverse order and tighten to 25 Nm.

The handling of the air cartridge (left bar) as well as the draining of the hydraulic cartridge (right bar) must be carried out by authorized persons.



It is important to clean the entire fork and the dust seals often. They make it possible to keep the fork oil seals in a clean environment. If the fork oil seals are damaged due to poor maintenance of the dust seals, their sealing will no longer be guaranteed. In this case, fork oil can leak onto the front brake disc, severely degrading the quality of brake and can therefore cause accidents. It is therefore important to regularly check the condition of the fork oil seals and therefore the absence of oil on the fork legs.

11.6 Air pressure adjustment

- Stop the motorcycle (🔧 9.5).
- Install the motorcycle on a stand, wheels in air (🔧 12.1).
- Remove the upper cap of the fork with hand (it's possible that the cap is locked, you have to unscrew the upper clamp screw to leave the cap).

Need tool: standard air pump (same as bicycle)

Left fork tube (brake side)

Pilot weight with equipment (Standard pressure **7 bar**)

-than 55kg	55 to 65kg	65 to 75kg	75 to 85kg	85 to 100kg	+ than 100kg
6 bar	6 à 6,5 bar	6,5 à 7 bar	7 à 8 bar	8 à 9 bar	9 à 10 bar

At each air pressure adjustment, the fork should be totally free (**maximal extension, front wheel in air**)

After each air pressure adjustment, **move the fork slowly in the 10 first mm of stroke for the air equilibrium**, and after check again the air pressure.

Right fork tube

Standard pressure standard **0,5 bar**.

You can adjust the pressure from 0.5 Bar to 3.0 Bar, It will change the fork behavior like below:

- Less pressure = Less harder in compression and less faster in extension
- More pressure = More harder in compression and more faster in extension

11.3 Extension adjustment

The extension is regulated by the screw placed at the bottom of the right bar.

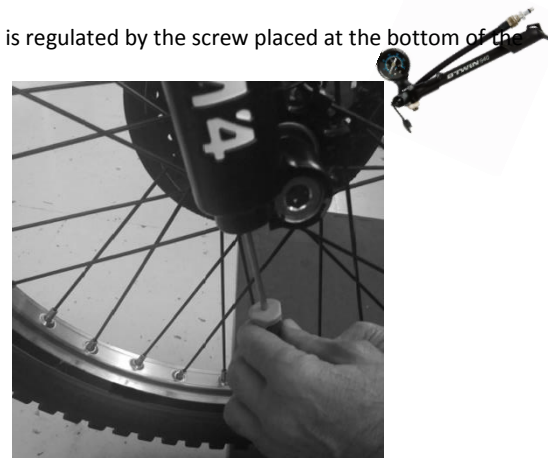

For a faster reaction in extension must open, and close for a slower reaction.

Proceed in stages, do not try to change more than one setting at a time. First act on one setting changing 2 or 3 clicks and decide to change again after trying. If you are lost or confused, return to basic settings.

Basic settings:

Extension: 10 clicks opened from closed position

Caoutchouc ring

This ring is install to verify the maximal stroke of the fork.

This ring should be always **at least at 5mm from the lower clamp.**

If you have less than 5mm, adjust your fork air pressure adjustment

(👉 11.2)



12.1 Clutch oil maintenance (RACE)

- Remove the battery
- Process can be done with or without the engine plate protector mounted
- Open the filler cap 1

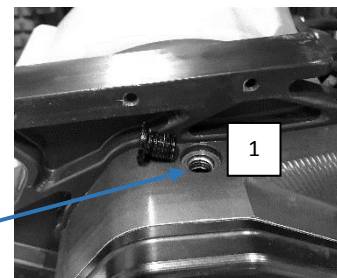

- Open the drain plug 2
Be careful: the oil will flow, install an oil container

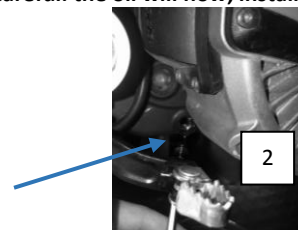

- Wait the complete oil change
- Clean the magnet on the drain plug
- Install again the drain plug with the cooper washer, screw tightening 17Nm
- Fill the transmission with **260 ml of oil 75W**

Recommended oil ELF HTX 740

- Le oil level should be on the middle of the oil level indicator
- Install again the filler cap 1 with the cooper washer, screw tightening 17Nm
- Install again the battery

Maintenance frequency:

Verify the oil level: each **20 hours**

Change clutch oil: each **40 hours**

INDEX

Adapt the bike to the driver.....	A	37	Technical data.....	T	15
Stop and crouch.....		35	Top up the brake fluid level.....		67
Braking.....	B	33, 34	Using the vehicle.....	U	30
Charging the battery.....	C	27	View of the vehicle	V	
Check before use.....		30	Right view.....		14
Clean the bike.....		35	Left view.....		14
Motor behavior adjustment.....	M	32			
Security.....	S	7			
Starting the bike.....		31			
Storing the bike.....		36			