

INSTALL GUIDE

**Covers All 32xx and 33xx Series
Advanced 2-Way Remote Starters**

REMOTE STARTERS

CAR ALARMS



**ULTRA
START**

www.ultrastarters.com

Technical Support: 866-698-5872 ext 0

support@ultrastarters.com

Note: Some features may not be available on certain models.

Warning!!

CARBON MONOXIDE MAY CAUSE SERIOUS INJURY, EVEN DEATH!

It is the sole responsibility of the user to place the system in Service Mode when parking in an enclosed area *ex: garage*, partially enclosed area *ex: carport*, or when the vehicle is being serviced.

Table of Contents

Table of Contents	Page 2
Component/Feature List	Page 3
Recommend Installation Procedures	Page 4-5
Wiring Diagrams	Page 6-7
Wire Description	Page 8-9
6 Pin Connector	
Auxiliary Connectors	
Optional Connectors	
Jumper Positions	
Quick Start Installation	Page 10
Basic Installation	
Plug-in The Module	
Manual Transmission Vehicles	Page 11
Additional Connections	
Clutch Bypass	
Important Tach Notes	Page 12-13
Auto Tach Learn	
Quick Tach Learn	
Program Overview and Quick View Programming	Page 14-15
Entering Program Mode	
Quick View Programming	
System Reset	
Programming Menus	Page 16-20
Program Menu 1 (User Settings)	
Program Menu 2 (Additional Settings)	
Program Menu 3 (Starter Settings)	
Program Menu 4 (Tach Settings)	
Remote Transmitter	Page 21
Transmitter Programming	
Battery Replacement	
Door Lock Relay Wiring Diagrams	Page 22-23
Diagnostics	Page 24

Components

- Control module
- Antenna with built in Program Button and LEDs
- 4 button 2-way and 4 button OE remote transmitter's
- Owner and Install guide's
- 6 pin Main harness
- 14 pin auxiliary harness
- 3 pin keyless entry harness
- 2 pin auxiliary harness*
- 3 pin auxiliary harness*
- Hood pin switch

*33xx series only

Feature List

- Auto Tach (Tachless, TL series only) learning with Quick Learn
- Run Time: 4/15/45 minutes
- Door locks: .125s/.75s/3s / Double unlock / Ignition lock/unlock
- Horn output 5ms/10ms/50ms
- Timer or Cold Start (LT series) with 3 different start intervals
- Programmable Wait to Start or (+/-) diesel Glow plug input
- Ground While Running/Anti-grind protection/Starter kill
- System Override Protection/Service Mode (Valet)
- Park light and LED diagnostics
- Car Finder mode
- Engine Idle mode
- Panic mode
- Turbo Timer mode

Please read manual thoroughly.

If the vehicle is a **MANUAL TRANSMISSION**, a “M” series remote starter must be installed. Any model number followed by the letter “M” is specially designed for **MANUAL TRANSMISSION** vehicles. The “M” series remote starter will not work in an **AUTOMATIC TRANSMISSION** vehicle.

Recommended Installation Procedures

Remote car starters and alarms should be professionally installed. Review the installation and owner manuals and acquire a vehicle wiring diagram for the vehicle to be worked on. Take a few moments to walk around the vehicle looking for any damages and make note if any are found. Also check other functions such as the lighting system, warning or check engine lights. Check if the vehicle has a factory security or anti-theft system (Transponder or PASS-LOCK). These systems will require additional parts and labor to complete the installation. Use of the proper tools and testing equipment is also very important. **Never** use a grounding style test light. Use only a **circuit safe** test light or digital **Volt/Ohm meter** to test for wires in the vehicle. It is the sole responsibility of the installer to test and verify all connections.

Proper Connections - Remote Starters can handle loads of up to 30 amps for extended periods of time. It is critical to insure that all high current connections are properly soldered and insulated with quality electrical tape. Failing to insure proper connections will result in warranty being VOID and can result in damage to the vehicle and remote starter module. The manufacture is not responsible for any such damages. It only takes a few more minutes to do the job right.

Under Hood Connections - Route the hood pin and tach wire through the firewall into the engine compartment. If possible route the wires through a factory rubber grommet. If drilling a hole through the firewall, **BE CAREFUL**. Always check for obstructions on both sides of the firewall. After drilling, use a snap in grommet to protect the wires from sharp edges. Use split loom to insulate the wires, route the wires clear of moving parts and extreme heat. The hood pin switch must always be installed and the tach wire should always be soldered and taped properly.

Recommended Installation Procedures

Mounting The Control Module - Never mount the module in the engine compartment. Select a location under the dash to install the main module. Be certain that the module is securely attached and does not obstruct any serviceable areas. Do not force or jam the module into tight places instead of mounting. The module must be free from all moving parts such as brake, clutch and gas pedal linkages. Do not place the module directly in front of a heater vent.

Installing the External Long Range Antenna - To insure the best possible reception, place the antenna in the center of the windshield below the tint screen and behind the rear view mirror. Before attaching to the glass ensure that the surface is clean and dry. Run the cable under the head liner and behind the A-pillar panel. Be careful not to pinch the antenna cable. Plug the antenna into the **BLUE** connector on the Control Module.

Testing The System - When the installation is complete, it will be necessary to test that the system is working correctly. The system's default programming will work on the majority of vehicles, but might need to be adjusted for some applications. If the installation requires special timing or additional features, proceed to Program Mode. The system must be Tach Learned (Tachless learned on TL models) before the remote starter will make a start attempt. If the remote starter does not make a start attempt check if the park lights are flashing a diagnostic code, if so look the code up in the Diagnostic Chart to find the shutdown input that is preventing the system from starting. If the vehicle does make a start attempt but fails to start. Check all connections and insure that all wiring is connected correctly. The vehicle may be equipped with a factory anti-theft system. Vehicles equipped with factory anti-theft systems will usually have some sort of *Security* or *Anti-Theft* light located in the instrument cluster.

Wiring Diagram

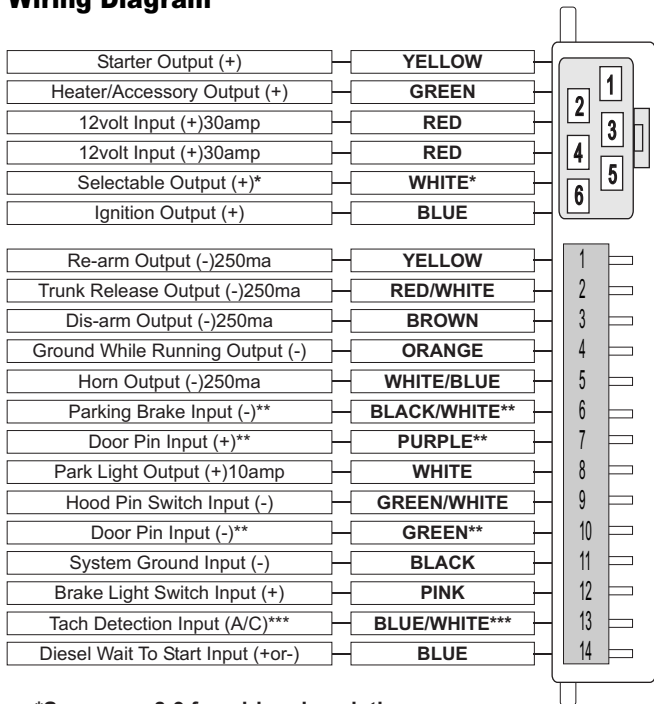

*See pages 8-9 for wiring descriptions.

** "M" series MANUAL TRANSMISSION vehicles only!!!

*** Optional connection on "TL" models

NOTE: 250ma outputs are low current and may require additional parts (relays) to active optional features.

Wiring Diagram

*The centre pin of the keyless entry harness is **ONLY** available with plug-in devices such as the VP-1, DL-3, DL-7 and Data Bus Modules.

Overloading this output will damage the remote starter.

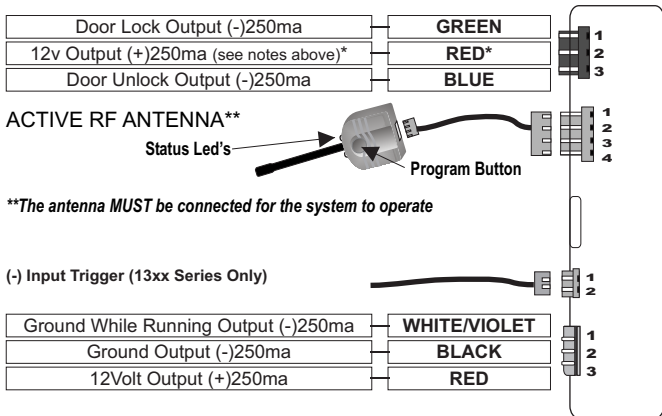

The antenna **MUST be connected for the system to operate

(-) Input Trigger (13xx Series Only)

NOTE: The 2 pin white and 3 pin white auxiliary connectors are not available on the 32xx series.

Output on White wire	Jumper position
Second Starter	Position 1
Second Accessory	Position 2
Second Ignition	Position 3

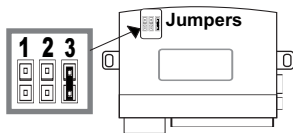

NOTE: The jumpers control the output from the **WHITE** wire on the main 6- pin harness. This is an **30amp relayed output**.

*The factory default setting of the Selectable Output jumper is position #3.

Wiring Descriptions

MAIN CONNECTOR (6pin)

Pin	Function	Description
1-YELLOW	Starter Output	- This wire will test 0V in OFF, ACCESSORY and in the ON key positions. 12v during START ONLY.
2-GREEN	Heater/Acc Output	- This wire will test 0V in the OFF and START key positions. 12-14V in the ACCESSORY and RUN key positions.
3-RED	12volt Input(30amp)	- Supplies 12volts for the IGNITION, PARK LIGHT and SELECTABLE outputs.
4-RED	12volt Input(30amp)	- Supplies 12 volts for ACCESSORY and STARTER outputs.
5-BLUE	Ignition Output	- This wire will test 0V in the OFF and ACCESSORY key positions. 12V in the IGNITION, START and RUN positions.
6-WHITE	Selectable Output	- Output for 2nd IGNITION, 2nd ACCESSORY or 2nd STARTER.

AUXILIARY CONNECTOR (14pin)

Pin	Function	Description
1-YELLOW	Re-arm(-)	- 0.75 second pulse output when Ⓜ is pressed and after remote start shutdown. Used for factory alarm re-arm. (Menu 3)
2-RED/ WHITE	Trunk Release(-)	- Programmable output. Hold Ⓜ or Ⓢ button for 3 seconds, output will stay active (max 5 seconds) or (-)park light.
3-BROWN	Dis-arm(-)	- 0.75 second pulse when Ⓜ and is pressed and before remote starter activation. Used for factory alarm dis-arm.
4-ORANGE	Ground When Running(-) /Starter Kill	- Output active during remote start. Programmable Starter Kill. (Menu 3)
5-WHITE/ BLUE	Horn(-)	- Output to activate factory horn. (Menu 1&2)
6-BLACK/ WHITE	Parking Brake(-)	- Input to detect (-) when parking brake switch is applied. ("M" series)
7-PURPLE	Door Pin(+)	- Input to detect 12v when door is open. ("M" series)
8-WHITE	Park Light(+)	- 10amp positive output to activate park lights. Programmable output (menu 2)

Wiring Descriptions

Pin	Function	Description
9-GREEN/ WHITE	Hood Pin(-)	Input to detect ground when hood is open. MUST BE CONNECTED.
10-GREEN	Door Pin(-)	Input to detect (-) when door is open. ("M" series)
11-BLACK	Ground(-)	System chassis ground input.
12-PINK	Brake Light (+)	Positive brake light switch input. Used to detect the brake switch being applied.
13-BLUE/ WHITE	Tach(A/C)	A/C Tach signal input. Used to detect engine speed to indicate vehicle is running. (Coil, Injector, cam/crank position sensors)
14-BLUE	Diesel(+/-)	Programmable Wait to Start Input. Detects 12v or negative signals. (Menu 3)

LOCK/ UNLOCK CONNECTOR (3pin red)

Pin	Function	Description
1-GREEN	Lock(-)	Programmable LOCK output. (Menu 1)
2-RED	12volts	250ma 12volt output for relays.
3-BLUE	Unlock(-)	Programmable UNLOCK output. (Menu 1)

ANTENNA CONNECTOR (4pin Blue)

RF Antenna with Program Button and LEDs

TEMP SENSOR or INSTANT START CONNECTOR (2pin white)*

Connector for Instant Start or Temperature Sensor inputs.

AUXILIARY CONNECTOR (3pin white)*

Pin	Function	Description
1-WHITE/ VIOLET	Ground While Running(-)	250ma ground output while remote starter is active.
2-BLACK	Ground(-)	250ma ground output.
3-RED	12volts(+)	250ma 12volt output.

***13xx Series Only**

Step 1 - Connect All Of the Following Wires

Main Connector (6pin)

YELLOW	Starter Output - 12volts during start position only.
GREEN	Heater/Acc Output - 12volts in the accessory position off during start and 14volts during run.
RED	12volt 30amp Input - 12volts from ignition harness or battery.
RED	12volt 30amp Input - 12volts from ignition harness or battery.
BLUE	Ignition Output - 12volts in the ignition, start and run positions.
WHITE*	Selectable Output - Selectable Output for vehicles that may require a 2nd Ignition, Accessory or Start.

*(See jumper diagram page 7)

Auxiliary Connector (14pin)

BLACK	System Ground Input - Connect to Chassis Ground.
WHITE	Park Light Output - Connect to Park Light system.
GRN/WHT	Hood Pin Input - Connect to the Hood Pin Safety Switch.
BLUE/WHT*	Tach Input - Connect to A/C Tach source. (Above 2 volts AC)
PINK	Brake Switch Input - Connect to (+) when the brake pedal is applied.

*Not necessary on TL models only.

“M” Series (yellow cases)

BLK/WHT	Park Brake Input - Connect to Park Brake wire.
GREEN** or	Door pin Input - Connect to (-) wire when door open
PURPLE**	Door pin Input - Connect to (+) wire when door open

NOTE: Blue/White must be connected on “M” series.

**Connect only ONE of the door input wires.

Important!

Never install an AUTOMATIC TRANSMISSION module into a MANUAL TRANSMISSION vehicle!

Manual Transmission “M” Models

Never install an automatic transmission remote starter into a manual transmission vehicle!!! Doing so may result in serious injury or death. Do not install remote starters in convertible vehicles! The following wires must be connected in addition to the basic remote starter installation.

Park Brake Input- This wire is located at the park brake switch. The wire will switch to (-) when the park brake is applied.

Never connect the Black/White wire straight to a ground!!!

(-) Door Pin Input- A negative door pin wire will be (+) or neutral when the door is closed then switch to (-) when the door is opened.

Always ensure that all the vehicles doors are sensed.

(+) Door Pin Input- A positive door pin wire will be (-) or neutral when the door is closed then switch to (+) when the door is opened.

Always ensure that all the vehicles doors are sensed.

NOTE: Blue/White must be connected on “M” series.

If any Door Pin Switches or the Park Brake Switch is not working correctly...

“DO NOT INSTALL UNTIL THE VEHICLE IS REPAIRED!!!”

Clutch Bypass - In most cases the clutch switch will need to be bypassed during remote starting. This is a temporary bypass, the clutch switch should never be disconnected or altered to not work as it is intended to “As a Safety Switch”. The clutch switch is usually a 2 wire switch mounted directly to the clutch pedal. There are several types of clutch switches that operate in one of the following ways:

Type 1 - Starter Wire Bypass - The starter wire travels from the key switch through the clutch switch to the starter motor. Connect the remote starters Starter Output wire directly to the starter motor side of the clutch switch.

Type 2 - Negative (High Current) - This switch grounds the factory starter relay and allows the vehicle to start. Connect a relay to ground the output side of the clutch switch wire when the remote starter is activated. The starter wire is connected at the ignition switch.

Type 3 - Connect Switch - Install a relay to connect the two wires at the switch when the remote starter is activated. The starter wire is connected at the ignition switch.

Type 4 - Disconnect Switch Install a relay to disconnect one of the wires at the clutch switch. The starter wire is connected at the ignition switch.

Testing for the correct wire is critical! Never connect to a circuit if you are not sure of its operation. Contact your dealer or technical support for more information.

Auto Tach (Tachless) Learn

IMPORTANT! The system must be Tach Learned before remote starting.
The Auto Tach Learn is the same for the TL (tachless) series.

- 1) Turn the ignition key to the "ON" position. The park lights* will turn "ON"
 - 2) Start the vehicle with the key. The LEDs on the antenna will turn on if a proper tach signal is detected**, after 30-35 seconds the park lights will flash and the horn (Optional) will honk twice to confirm Tach Learn.
- * If the park lights do not turn on check for proper connection on the BLUE ignition wire at the 6-pin connector. This wire should be connected to the vehicle main ignition wire and must not turn off during the start position. If the ignition connection is correct, reset the system (see System Reset page 15) and repeat step #1.
- ** If the LEDs do not come "ON" during tach learn, a proper tach signal was not detected.

NOTE: The LEDs will not turn "ON" for Auto Tach Learn on the TL series.

If the park lights do not flash in Auto Tach Learn mode it may be necessary to connect to a different tach source. It is important the ignition output from the remote starter is connected to a wire that does not turn off in the crank position. The remote starter will not tach learn if connected to the wrong wire.
For best results connect the tach wire to the coil pack or to a fuel injector wire.

New - If the original Tach source is changed a system reset must be preformed before a new tach signal can be learned to the system. This does not apply if the Quick Learn feature is being used. (See page 15 for System Reset).

Your Basic Install Is Complete!

NOTES:

- 1) If the vehicle does not start when the remote starter is activated, the park lights will flash a diagnostic code. (See Diagnostic Chart page 24).
- 2) If the vehicle still does not start, check all connections and check for factory Anti-Theft system.

Important Tach Notes

Tach Learning the remote starter is one of the most important steps in the installation process. Do not tach learn vehicle while the engine is in high idle. To ensure the best possible tach setting, ensure that the vehicle is at low idle/ normal operating RPM. Vehicles such as Toyota and Honda may idle much higher when the engine is warm compared to starting the vehicle when the engine is cold. The Quick Learn feature may be used to tach learn the vehicle again but at a normal engine RPM.

Quick Learn Tach

Quick Learn Tach is designed to re-learn the remote starters tach setting while the vehicle is at normal idle RPM. Vehicles such as Toyota and Honda will run at a very high idle for a number of minutes when first started. If tach learned when the vehicle is at high Idle, then remote started when the vehicle is cold. The engine does not increase to the RPM that it was learned at. The following steps can be used to learn tach at a more suitable idle:

1) Start the vehicle and leave it running with the ignition key until the engine idles down.



2) Press and hold the brake pedal.



3) Press and release, then press and hold the Program Button.



4) The park lights will flash to confirm Quick Learn Tach.

NOTE: The System MUST be “Tach Learn” before the “Quick Learn” feature will function.

TIP: “Manual Low Idle Learn”. While in “Auto Tach Learn” mode, firmly apply the park brake and press the brake pedal. Place the transmission into reverse gear this will lower the Engine Idle.

Entering Program Mode

Ignition 3x On/Off On/Off On	Press and Release the Program Button	For Menu 1, press the Ⓜ button	For Menu 2, press the Ⓜ button	For Menu 3, press the * button	For Menu 4, press the # button
------------------------------------	--	--------------------------------------	--------------------------------------	--------------------------------------	--------------------------------------



- 1) With the ignition in the OFF position, turn the ignition key from “Off” to “On” 3 times, ON-OFF-ON-OFF-ON within three seconds.

NOTE: Leave the key in the ON position

- 2) Press and release the Program Button. The park lights will flash and the horn (optional) will honk to confirm entering program mode.
- 3) Select desired Program Menu (See below). The park lights will flash and horn (optional) will honk to confirm the selected menu.
- 4) Select Programmable Setting:
 - a) *Press and release* the Program Button the correct number of times to select the desired Program Setting. The park lights and LEDs will flash and the horn (optional) will honk to indicate the Program Setting that has been selected. *For example:* 1 flash/honk= Program Setting 1; 2 flashes/honks= Program Setting 2; etc...
 - b) *Press and Hold* the Program Button until the park lights flash and the horn(optional) honks to confirm the desired setting. *For example:* 1 flash/honk= Setting 1; 2 flashes/honks= Setting 2; 3 flashes/honks= Setting 3.
 - c) Turning the ignition key to the “Off” position or 30 seconds of no activity will exit Program Mode. This will be confirmed with a light flash and a long horn (optional) honk. The Program Menu may be changed at any time by pressing the transmitter button (below), this will allow the installer to jump from one menu, then quickly jump to another menu and change another setting without re-entering Program Mode.

Program Menus

Menu 1: User Settings (Ⓜ Button)

Page 16

This program menu is for the adjustments for the user and door lock options.

Menu 2: Additional Settings (Ⓜ Button)

Page 17

This program menu is for additional settings.

Menu 3: Starter Settings (* Button)

Page 18-19





This program menu is for various remote car starter applications.

Menu 4: Tach Settings (# Button)

Page 20

This program menu is for tach signal adjustments.

Quick View Programming

Menu 1 - Press 	1 Flash	2 Flashes	3 Flashes
1 Ignition Lock	Enabled	Lock Only	Disabled
2 Horn Honk	Type 1	Type 2	All Honks
3 Lock&Unlock Options	Double Unlock	3 second	3/4 second
4 Unlock/Disarm	125ms	750ms	
Menu 2 -Press 	1 Flash	2 Flashes	3 Flashes
1 Secure Service Mode	15 seconds	5 seconds	
2 Park Light Output	30 seconds	(-) Park Light	(+)Park Light
3 Horn Timing	5ms	50ms	10ms
4 Button #4 ( Button)	N/A	N/A	Car Finder
5 Reservation Mode	Manual	Auto Reservation	
Menu 3 -Press 	1 Flash	2 Flashes	3 Flashes
1 Lock/ Unlock Type	Type 1	Type 2	Normal
2 Gas/ Diesel	Negative	15 second	Gas/Positive
3 Rearm Output	Type 1	Type 2	Rearm
4 Run Time	4 Min	45 Min	15 Min
5 Crank Time	10 seconds	3 seconds	5 seconds
6 Starter Disable/GWR	Active	Passive	GWR
Menu 4 -Press 	1 Flash	2 Flashes	3 Flashes
1 Low Idle Learn	Low Idle Learn		
2 Adjust For Over Crank	Reduced by 10%		
3 Adjust For under Crank	Increased by 10%		

****Bold type indicates settings that are Factory Default.**

System Reset

The system reset will clear any changes made to the Program Menu's as well as the Tach setting. When the system reset is complete the system must be Tach learned before the remote starter will operate.

- 1) Turn the ignition key from "Off" to "On" 3 times, **ON-OFF-ON-OFF-ON** within three seconds. (Leave the key in the **ON** position)
- 2) Press and release the **Program Button** located on the antenna. The park lights will turn on and the horn (optional) will honk one time.
- 3) Then press and hold the **Program Button** until the park lights flash and the horn (optional) will honk 3 times slowly to confirm system reset.

System is now reset to factory defaults.

NOTE: System Reset **does not** delete the transmitter codes from memory.

* See the following pages for more detailed programming instructions.

Menu 1- User Settings



Ignition 3x
On/Off
On/Off On



Press and
Release the
Program
Button



Press and
Release the
Ⓢ button for
Menu 1



Press and Release
the Program Button
of Times for
Setting Chosen



Press and Hold
the Program Button
to Change Option

Setting 1 Ignition Auto Lock

- | | | |
|------------------------------|-----------------|---|
| 1) Enable | 1 Flash/Honk | Doors Lock/Unlock with Ignition key. |
| 2) Ignition Lock Only | 2 Flashes/Honks | Doors Lock when ignition is turned "ON" only. |
| *3) Disable | 3 Flashes/Honks | Lock/Unlock with remote transmitter ONLY |

Press & Release the Program Button 1 Time (Setting 1) Confirmed with 1 LED flash.

Press & Hold the Program Button until the appropriate # of park lights/horn (optional) honks, then release

Press & Release the Program Button to proceed to the next step.

Setting 2 Horn Honk Settings (Auxiliary Connector Pin 5)

- | | | |
|--------------------------------------|-----------------|----------------------------------|
| 1) Lock/Unlock chirps Disable | 1 Flash/Honk | Honks for Panic/Car Finder Only. |
| 2) Lock/Unlock chirps Enable | 2 Flashes/Honks | No Honks for Start ONLY |
| *3) All Chirps Enable | 3 Flashes/Honks | Honks for all features. |

Press & Release the Program Button 2 Times (Setting 2) Confirmed with 2 LED flashes.

Press & Hold the Program Button until the appropriate # of park lights/horn (optional) honks, then release.

Press & Release the Program Button to proceed to the next step.

Setting 3 Door Lock Options

- | | | |
|--------------------------------------|------------------------|--|
| 1) Double Unlock Pulse | 1 Flash/Honk | .75 Second lock & 2 unlock pulses |
| 2) 3 Second Lock & Unlock | 2 Flashes/Honks | 3 Second Lock & Unlock Pulses |
| *3) .75 Sec Lock & Unlock | 3 Flashes/Honks | .75 Second Lock & Unlock Pulses |

Press & Release the Program Button 3 Times (Setting 3) Confirmed with 3 LED flashes.

Press & Hold the Program Button until the appropriate # of park lights/horn (optional) honks, then release.

Press & Release the Program Button to proceed to the next step.

Setting 4 Door Unlock & Disarm Pulse Duration

- | | | |
|-------------------|-----------------|---|
| 1) Short Pulses | 1 Flash/Honk | 125ms pulses on Unlock & Disarm outputs |
| *2) Normal Pulses | 2 Flashes/Honks | 750ms pulses on Lock/Unlock & Disarm outputs |

Press & Release the Program Button 4 Times (Setting 4) Confirmed with 4 LED flashes.

Press & Hold the Program Button until the appropriate # of park lights/horn (optional) honks, then release.

Press & Release the Program Button to proceed to the next step.

NOTE: Settings 5, 6 and 7 are not available.

Menu 2- Additional Settings



Ignition 3x
On/Off
On/Off On



Press and
Release the
Program
Button



Press and
Release the
Ⓟ button for
Menu 2



Press and Release
the Program Button
of Times for
Setting Chosen



Press and Hold
the Program Button
to Change Option

Setting 1 Secure Valet Mode (time required to set the system into Service Mode)

- 1) Secure Valet 1 Flash/Honk Hold the Program Button for 15 seconds
*2) Normal Valet 2 Flashes/Honks Hold the Program Button for 5 seconds

Press & Release the Program Button 1 Time (Setting 1) confirmed 1 LED flashes.

Press & Hold the Program Button until the appropriate # of park light/horn (optional)honks, then release.

Press & Release the Program Button to proceed to the next step.

Setting 2 Parking Light/Trunk Output (14 pin auxiliary connector pins 2&8)

- 1) 30 sec. Output 1 Flash/Honk On for 30 seconds when Ⓟ is pressed
2) Negative Park Lights 2 Flashes/Honks Switches the Park Lights/Trunk Outputs
*3) Park Lights 3 Flashes/Honks 2 Flashes when Ⓟ is pressed

Press & Release the Program Button 2 Times (Setting 2) confirmed 2 LED flashes.

Press & Hold the Program Button until the appropriate # of park light/horn (optional)honks, then release.

Press & Release the Program Button to proceed to the next step.

Setting 3 Horn Honk Timing (14 pin auxiliary connector pin 5)

- 1) 5 ms Pulse Output 1 Flash/Honk Short(Quiet) Horn Output Pulses
2) 15 ms Pulse Output 2 Flashes/Honks Long(Loud) Horn Output Pulses
*3) 10 ms Pulse Output 3 Flashes/Honks Normal(Medium) Horn Output Pulses

Press & Release the Program Button 3 Times (Setting 3) confirmed 3 LED flashes.

Press & Hold the Program Button until the appropriate # of park light/horn (optional)honks, then release.

Press & Release the Program Button to proceed to the next step.

Setting 4 Ⓟ Button Operations

- 1) N/A
2) N/A
*3) Car Finder 3 Flashes/Honks Ⓟ Button activates Car Finder Mode

Press & Release the Program Button 4 Time (Setting 4) confirmed 4 LED flashes.

Press & Hold the Program Button until the appropriate # of park light/horn (optional)honks, then release.

Press & Release the Program Button to proceed to the next step.

Setting 5 Reservation Mode ("M" units only)

- 1) Manual Reservation 1 Flash/Honk Activate Reservation Mode by pressing Ⓟ Button
*2) Auto Reservation 2 Flashes/Honks Activate Reservation Mode by pressing brake

Press & Release the Program Button 5 Time (Setting 5) confirmed 5 LED flashes.

Press & Hold the Program Button until the appropriate # of park light/horn (optional)honks, then release.

Press & Release the Program Button to proceed to the next step.

Menu 3- Starter Settings



Ignition 3x
On/Off
On/Off On



Press and
Release the
Program
Button



Press and
Release the
* button for
Menu 3



Press and Release
the Program Button
of Times for
Setting Chosen



Press and Hold
the Program Button
to Change Option

Setting 1 Special Door Lock/Unlock Operations (Factory Alarm Rearm).

- 1) Type 1 1 Flash/Honk Unlock before start. Lock pulse after start and shutdown.
2) Type 2 2 Flashes/Honks Lock pulse ONLY after remote start shutdown.

***3) Type 3 3 Flashes/Honks Default Lock/ Unlock Pulses.**

Press & Release the Program Button 1 Time (Setting 1) Confirmed with 1 LED flashes.

Press & Hold the Program Button until the appropriate # of park lights/horn (optional) honks, then release.

Press & Release the Program Button to proceed to the next step.

Setting 2 Gas/Diesel Mode (Auxiliary Connector Pin 12, 12xx series)

- 1) (+) Input 1 Flash/Honk (+) Glow Plug input. Waits maximum 30 seconds
2) Time Delay 2 Flashes/Honks Waits for approximately 15 seconds.

***3) Gas/ (-) Input 3 Flashes/Honks Waits 2 seconds if no diesel input is detected.**

Press & Release the Program Button 2 Times (Setting 2) Confirmed with 2 LED flashes.

Press & Hold the Program Button until the appropriate # of park lights/horn (optional) honks, then release.

Press & Release the Program Button to proceed to the next step.

Setting 2 Gas/Diesel Mode (Auxiliary Connector Pin 12, 13xx series)

- 1) (-) Input 1 Flash/Honk (-) Glow Plug input. Waits maximum 30 seconds.
2) Time Delay 2 Flashes/Honks Waits for approximately 15 seconds.

***3) Gas/ (+) Input 3 Flashes/Honks Waits 2 seconds if no diesel input is detected.**

Press & Release the Program Button 2 Times (Setting 2) Confirmed with 2 LED flashes.

Press & Hold the Program Button until the appropriate # of park lights/horn (optional) honks, then release.

Press & Release the Program Button to proceed to the next step.

NOTE: Setting 2 will vary depending on the board layout 12xx or 13xx series..

Setting 3 Rearm Output (Auxiliary Connector Pin 1)

- 1) Type 1 1 Flash/Honk Pulse after start and with lock.
2) Type 2 2 Flashes/Honks Pulse after start only.
***3) Factory Re-arm 3 Flashes/Honks Pulse with lock and after starter shutdown.**

Press & Release the Program Button 3 Times (Setting 3) Confirmed with 3 LED flashes.

Press & Hold the Program Button until the appropriate # of park lights/horn (optional) honks, then release.

Press & Release the Program Button to proceed to the next step.

Menu 3- Starter Settings - continued

Setting 4 Run Time

- | | | |
|-----------------------|------------------------|--|
| 1) 4 Minutes | 1 Flash/Honk | Runs for approx. 4 minutes when activated. |
| 2) 45 Minutes | 2 Flashes/Honks | Runs for approx. 45 minutes when activated. |
| *3) 15 Minutes | 3 Flashes/Honks | Runs for approx. 15 minutes when activated. |

Press & Release the Program Button 4 Times (Setting 4) Confirmed with 4 LED flashes.

Press & Hold the Program Button until the appropriate # of park lights/horn (optional) honks, then release.

Press & Release the Program Button to proceed to the next step.

Setting 5 Maximum Crank Time

- | | | |
|----------------------|------------------------|---|
| 1) 10 Seconds | 1 Flash/Honk | 10 sec max time that the starter will stay engaged. |
| 2) 3 Seconds | 2 Flashes/Honks | 3 sec max time that the starter will stay engaged. |
| *3) 5 Seconds | 3 Flashes/Honks | 5 sec max time that the starter will stay engaged. |

Press & Release the Program Button 5 Times (Setting 5) Confirmed with 5 LED flashes.

Press & Hold the Program Button until the appropriate # of park lights/horn (optional) honks, then release.

Press & Release the Program Button to proceed to the next step.

Setting 6 Anti-Grind/Starter Kill (Auxiliary Connector Pin 4)

- | | | |
|----------------|------------------------|---|
| 1) Active | 1 Flash/Honk | (-)When locked and during remote start (Anti-Grind). |
| 2) Passive | 2 Flashes/Honks | (-)When locked/ 30 seconds after ignition is OFF or  pressed |
| *3) GWR | 3 Flashes/Honks | (-) Output during remote start only. (Anti-grind/ Bypass) |

Press & Release the Program Button 6 Times (Setting 6) Confirmed with 6 LED flashes.

Press & Hold the Program Button until the appropriate # of park lights/horn (optional) honks, then release.

Press & Release the Program Button to proceed to the next step.

Menu 4- Tach Settings



Ignition 3x
On/Off
On/Off On



Press and
Release the
Program
Button



Press and
Release the
button for
Menu 4



Press and Release
the Program Button
of Times for
Setting Chosen



Press and Hold
the Program Button
to Change Option

Setting 1 Low Idle Learn- Same function as doing the Quick Tach Learn.

This option is used for vehicles that maintain a High or Erratic idle after starting and need more than 30 seconds to establish a stable idle.

- 1) Enter Program Mode.
- 2) Press and release the # button on the remote.
- 3) Start the vehicle.
- 4) Press and release the Program Button (LEDs will be flashing one time)
- 5) Press and hold the Program Button for 3 seconds.
- 6) Release the Program Button. LEDs will be on steady to indicate correct tach signal. The park lights will flash twice and the horn (optional) will honk twice to confirm that the tach signal has been learned.

NOTE: Must Tach Learn (see page 12) before Low Idle or Quick Tach learn.

Setting 2 Over-Crank Adjustment.**

- 1) Enter Program Mode.
- 2) Press and release the # button on the remote.
- 3) Press and release the Program Button twice. (LEDs will flash 2 times consecutively)
- 4) Press and hold the Program Button.

NOTE: The park lights will flash and the horn will honk one time each time the park lights flash and the horn honks the setting is increased.

- 5) Release the Program Button. (Exit Program Mode and test remote starter)

Setting 3 Under-Crank Adjustment.**

- 1) Enter Program Mode.
- 2) Press and release the # button on the remote.
- 3) Press and release the Program Button three times. (LEDs will flash 3 times consecutively)
- 4) Press and hold the Program Button.

NOTE: The park lights will flash and the horn will honk one time each time the park lights flash and the horn honks the setting is increased.

- 5) Release the Program Button. (Exit Program Mode and test remote starter)

****Repeat steps 1-5 if necessary.**

Remote Transmitter Learn

IMPORTANT! All remote transmitters not programmed at this time will be erased from memory for security.

STEP 1 - Within 3 seconds turn the ignition key to the “ON” position three times leaving “ON” the third time.



STEP 2 - Press and hold the Program Button. The park lights will turn “ON” and the horn (optional) will honk once. **Continue to hold the Program Button**, the park lights will turn “OFF” and the horn (optional) will honk 5 times quickly.



NOTE: If the parking lights do not turn “ON”, release the Program Button and turn the ignition to the “OFF” position, wait 5sec and repeat steps 1 & 2.

STEP 3a (Default) - While holding the Program Button, press and release the  button on each of the remote transmitters to be programmed.



STEP 3b (PadLoc/ 2nd Car)* - While holding the Program Button, press and release the  button on each of the remote transmitters to be programmed.



PadLoc is a safety feature that “LOCKS” the remote transmitter. To “UNLOCK” the remote transmitter the  button must be pressed simultaneously with the function chosen.

or

2nd Car function allows the operation of two Ultra Start systems (in two separate vehicles) with one remote transmitter.

Example: Press and release  and  simultaneously to remote start.

NOTE: Some features not available with PadLoc or 2nd car mode.

Door Lock Relay Wiring Diagrams

Negative Type Door Locks 250ma

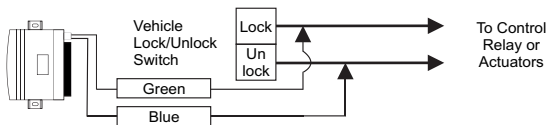

Negative Door Locks (More Than 250ma)

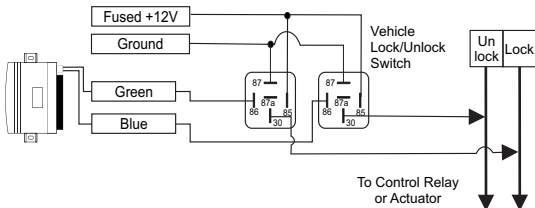

Positive Type Door Locks

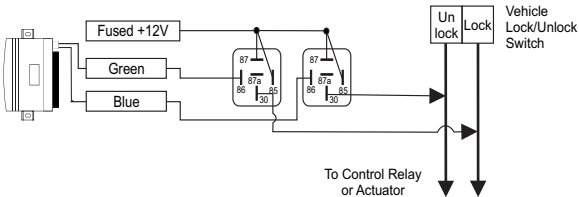

NOTE: When installing relays always use a fused power source.

Door Lock Relay Wiring Diagrams

5 Wire / Reverse Polarity Type Door Locks

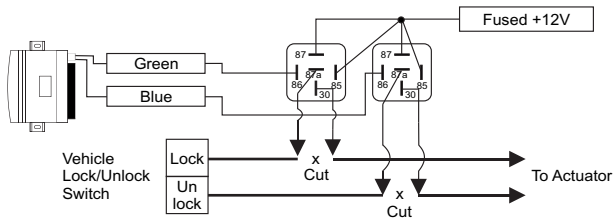

Aftermarket Doorlock Actuators

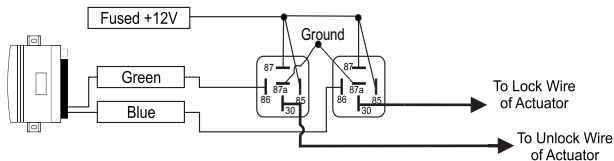

Vacuum Type Door Locks

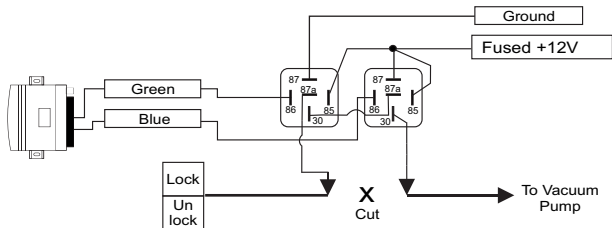

NOTE: When installing relays always use a fused power source.

DIAGNOSTICS

If the remote starter does not activate when the start button is pressed the park lights will flash a diagnostic to indicate what shutdown input has been triggered. For example: *If the  button is pressed the park lights flash 3 times slowly.* Looking at the chart below this would indicate that the system is in Service Mode, simply follow the instructions listed in the owners manual on exiting Service Mode and the remote starter will begin to function as normal.

PARK LIGHTS

3 Flashes
3 Slow Flashes
4 Slow Flashes
5 Flashes
5 Slow Flashes
6 Flashes
7 Flashes

STATUS LED

Series of 3 Flashes
LEDs "ON" Solid
Series of 4 Flashes
Series of 5 Flashes
Series of 5 Flashes
Series of 6 Flashes
Series of 7 Flashes

DIAGNOSTIC CODE

Door Opened "M" Models
System Is In Service Mode
Not in Reservation Mode*
Hood Open
Ignition On During Start Attempt
Brake Pedal Shutdown
Tach Lock-Out

* "M" series ONLY

DIAGNOSTIC MEMORY

LED Flashes

5 Flashes
6 Flashes
7 Flashes
8 Flashes

Diagnostic

The system was shutdown by the brake switch input
The system was shutdown by the hood pin input
The system did not detect the tach signal.
The system made 3 start attempts without starting

To Enter Diagnostic Memory Mode:

Step 1- Turn the ignition ON then OFF. Press and release the Program Button.

Step 2- The system will respond with three park light flashes and the horn (optional) will honk the same number of times as the events in memory.
Maximum four events, four honks

NOTE: If the horn does not honk, there are no events in memory.

Step 3- Press the Program Button once to view the last shut down code. The horn (optional) will honk once to confirm code one.
If the horn does not honk, there are no codes in memory.

Step 4- The LEDs on the antenna will flash a code corresponding to a shut down trigger. Press the Program Button again for the second code.
The horn will honk twice to confirm code two.

Step 5- To **Clear Diagnostic Memory.** While in Diagnostic Mode press and hold the Program Button for five seconds. The park lights will flash and the horn (optional) will honk once.

NOTE: Once diagnostic memory has 4 shutdown events in memory, the system will not Record any further shutdown events until the system memory has been cleared.