

# Lighting

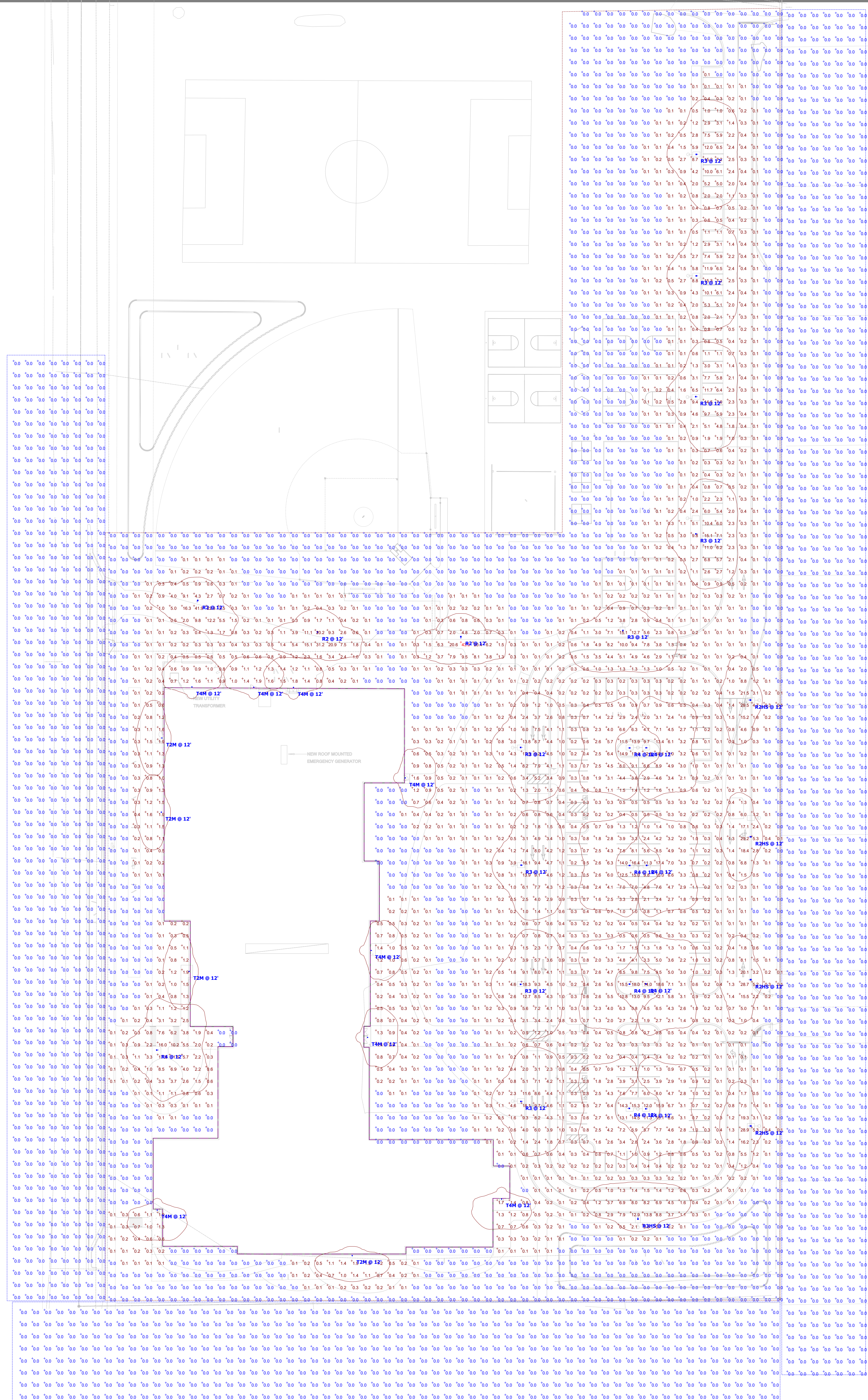

Plan View  
Scale: 1" = 40'

Schedule						
Symbol	Label	QTY	Manufacturer	Catalog Number	Description	LLF
	R2	3	Lithonia Lighting	RSX2 LED P2 40K R2	RSX Area Luminaire Size 2 P2 Lumen Package 4000K CCT Type R2 Distribution	17263.07
	R2HS	4	Lithonia Lighting	RSX2 LED P2 40K R2 HS	RSX LED Area Luminaire Size 2 P2 Lumen Package 4000K CCT Type R2 Distribution with HS shield	13051.98
	R3	9	Lithonia Lighting	RSX2 LED P2 40K R3	RSX Area Fixture Size 2 P2 Lumen Package 4000K CCT Type R3 Distribution	17201.52
	R3HS	1	Lithonia Lighting	RSX2 LED P2 40K R3 HS	RSX LED Area Luminaire Size 2 P2 Lumen Package 4000K CCT Type R3 Distribution with HS shield	12073.56
	R4	9	Lithonia Lighting	RSX2 LED P2 40K R4	RSX Area Fixture Size 2 P2 Lumen Package 4000K CCT Type R4 Distribution	17426.59
	T2M	4	Lithonia Lighting	WDGE2 LED P2 40K 80CRI T2M	WDGE2 LED WITH P2 - PERFORMANCE PACKAGE, 4000K, 80CRI, TYPE 2 MEDIUM OPTIC	2061.398
	T4M	8	Lithonia Lighting	WDGE2 LED P2 40K 80CRI T4M	WDGE2 LED WITH P2 - PERFORMANCE PACKAGE, 4000K, 80CRI, TYPE 2 MEDIUM OPTIC	2018.138

Statistics						
Description	Symbol	Avg	Max	Min	Max/Min	Avg/Min
Calc Zone #2	+	1.1 fc	43.0 fc	0.0 fc	N/A	N/A
EAST PROPERTY LINE	+	0.0 fc	0.0 fc	0.0 fc	N/A	N/A
SOUTH PROPERTY LINE	+	0.0 fc	0.0 fc	0.0 fc	N/A	N/A
WEST PROPERTY LINE	+	0.0 fc	0.0 fc	0.0 fc	N/A	N/A

### SITE POLE FIXTURE



**RSX2 LED**  
Area Luminaire



### Specifications

**EPA (ft<sup>2</sup>@0°):** 0.69 ft<sup>2</sup> (0.06 m<sup>2</sup>)

**Length:** 29.3" (74.4 cm) (SPA mount)

**Width:** 13.4" (34.0 cm)

**Height:** 3.0" (7.6 cm) Main Body  
7.2" (18.3 cm) Arm

**Weight: (SPA mount)** 30.0 lbs (13.6 kg)

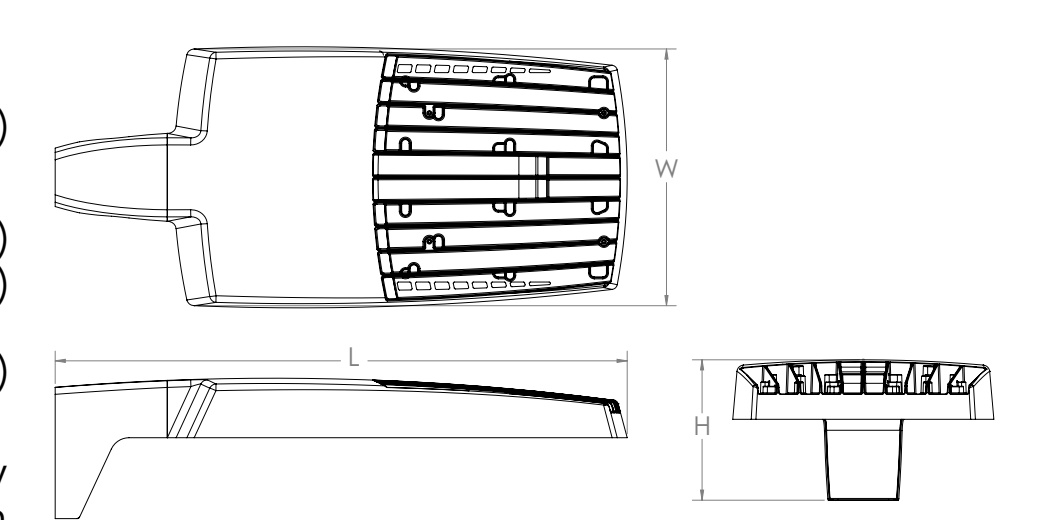

### WALL PACK FIXTURE



**WDGE2 LED**  
Architectural Wall Sconce  
Precision Refractive Optic



### Specifications

**Depth (D1):** 7"

**Depth (D2):** 1.5"

**Height:** 9"

**Width:** 11.5"

**Weight: (without options)** 13.5 lbs

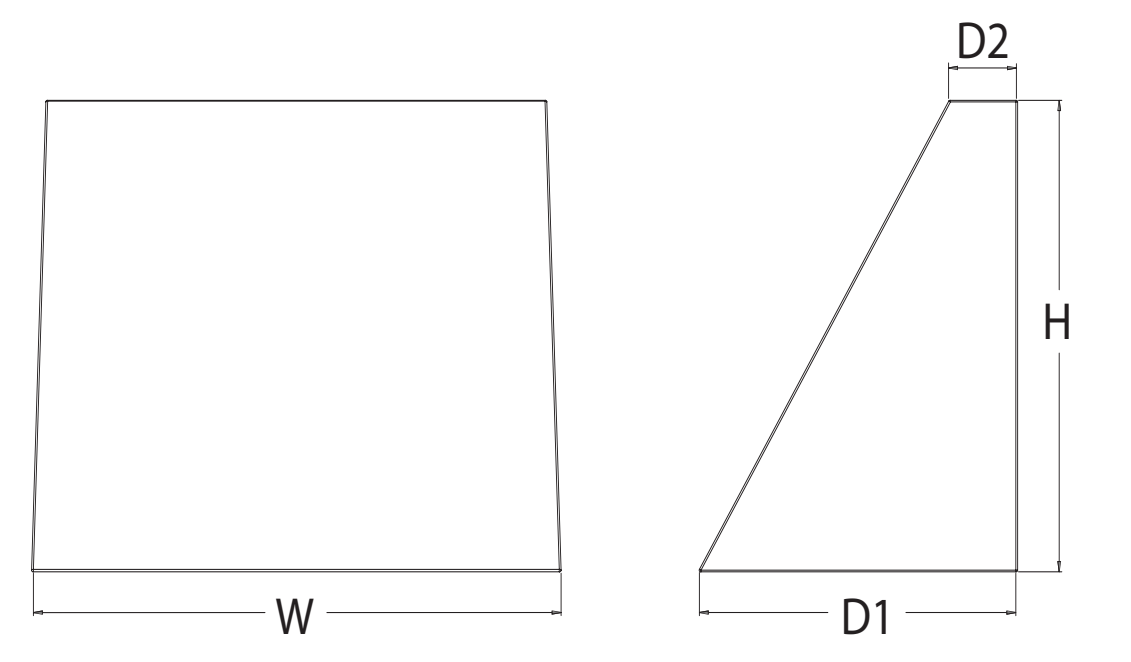



# RSX2 LED Area Luminaire



Catalog Number
Notes
Type

Hit the Tab key or mouse over the page to see all interactive elements.

## Specifications

<b>EPA (ft<sup>2</sup>@0°):</b>	0.69 ft <sup>2</sup> (0.06 m <sup>2</sup> )
<b>Length:</b>	29.3" (74.4 cm) (SPA mount)
<b>Width:</b>	13.4" (34.0 cm)
<b>Height:</b>	3.0" (7.6 cm) Main Body 7.2" (18.3 cm) Arm
<b>Weight: (SPA mount)</b>	30.0 lbs (13.6 kg)

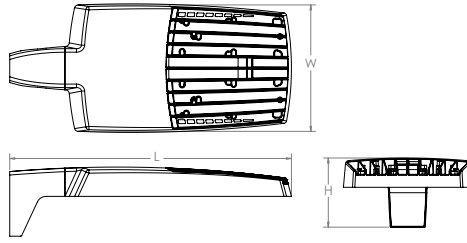

## Introduction

The new RSX LED Area family delivers maximum value by providing significant energy savings, long life and outstanding photometric performance at an affordable price. The RSX2 delivers 11,000 to 31,000 lumens allowing it to replace 250W to 1000W HID luminaires.

The RSX features an integral universal mounting mechanism that allows the luminaire to be mounted on most existing drill hole patterns. This "no-drill" solution provides significant labor savings. An easy-access door on the bottom of mounting arm allows for wiring without opening the electrical compartment. A mast arm adaptor, adjustable integral slipfitter and other mounting configurations are available.

## Ordering Information

**EXAMPLE:** RSX2 LED P6 40K R3 MVOLT SPA DDBXD

RSX2 LED					
Series	Performance Package	Color Temperature	Distribution	Voltage	Mounting
RSX2 LED	P1	30K 3000K	R2 Type 2 Wide	MVOLT (120V-277V) <sup>2</sup>	SPA Square pole mounting (3.0" min. SQ pole for 1 at 90°, 3.5" min. SQ pole for 2, 3, 4 at 90°) RPA Round pole mounting (3.2" min. dia. RND pole for 2, 3, 4 at 90°, 3.0" min. dia. RND pole for 1 at 90°, 2 at 180°, 3 at 120°) MA Mast arm adaptor (fits 2-3/8" OD horizontal tenon) IS Adjustable slipfitter (fits 2-3/8" OD tenon) <sup>6</sup> WBA Wall bracket <sup>1</sup> WBASC Wall bracket with surface conduit box AASP Adjustable tilt arm square pole mounting <sup>6</sup> AARP Adjustable tilt arm round pole mounting <sup>6</sup> AAWB Adjustable tilt arm with wall bracket <sup>6</sup> AAWSC Adjustable tilt arm wall bracket and surface conduit box <sup>6</sup>
	P2	40K 4000K	R3 Type 3 Wide	HVOLT (347V-480V) <sup>3</sup>	
	P3	50K 5000K	R3S Type 3 Short	XVOLT (277V-480V) <sup>4</sup>	
	P4		R4 Type 4 Wide	(use specific voltage for options as noted)	
	P5		R4S Type 4 Short	120 <sup>3</sup> 277 <sup>5</sup>	
	P6		R5 Type 5 Wide <sup>1</sup>	208 <sup>3</sup> 347 <sup>5</sup>	
			R5S Type 5 Short <sup>1</sup>	240 <sup>3</sup> 480 <sup>5</sup>	
			AFR Automotive Front Row		
			AFRR90 Automotive Front Row Right Rotated		
			AFRL90 Automotive Front Row Left Rotated		

Options	Finish
<p><b>Shipped Installed</b></p> <p>HS House-side shield<sup>7</sup></p> <p>PE Photocontrol, button style<sup>8,9</sup></p> <p>PEX Photocontrol external threaded, adjustable<sup>9,10</sup></p> <p>PER7 Seven-wire twist-lock receptacle only (no controls)<sup>9,11,12,13</sup></p> <p>CE34 Conduit entry 3/4" NPT (Qty 2)</p> <p>SF Single fuse (120, 277, 347)<sup>5</sup></p> <p>DF Double fuse (208, 240, 480)<sup>5</sup></p> <p>SPD20KV 20KV Surge pack (10KV standard)</p> <p>FAO Field adjustable output<sup>9,13</sup></p> <p>DMG 0-10V dimming extend out back of housing for external control (control ordered separate)<sup>9,13</sup></p> <p>DS Dual switching<sup>9,14</sup></p>	<p><b>Shipped Installed</b></p> <p><b>*Standalone and Networked Sensors/Controls (factory default settings, see table page 9)</b></p> <p>NLTAIR2 nLight AIR generation 2<sup>13,15,16</sup></p> <p>PIRHN Networked, Bi-Level motion/ambient sensor (for use with NLTAIR2)<sup>13,16,17</sup></p> <p>BAA Buy America(n) Act Compliant</p> <p><b>*Note: PIRHN with nLight Air can be used as a standalone dimming sensor with out-of-box settings or as a wireless networked solution. See factory default settings table. Sensor coverage pattern is affected when luminaire is tilted.</b></p> <p><b>Shipped Separately (requires some field assembly)</b></p> <p>EGS External glare shield<sup>6</sup></p> <p>EGFV External glare full visor (360° around light aperture)<sup>7</sup></p> <p>BS Bird spikes<sup>18</sup></p>
	<p>DDBXD Dark Bronze</p> <p>DBLXD Black</p> <p>DNAXD Natural Aluminum</p> <p>DWHXD White</p> <p>DBBTXD Textured Dark Bronze</p> <p>DBLBXD Textured Black</p> <p>DNATXD Textured Natural Aluminum</p> <p>DWHGXD Textured White</p>



## Ordering Information

### Accessories

Ordered and shipped separately.

RSX2HS	RSX2 House side shield (includes 2 shields)
RSX2EGS (FINISH) U	External glare shield (specify finish)
RSX2HSFRR (FINISH) U	RSX2 House side shields for AFR rotated optics (includes 2 shields)
RSX2EGFV (FINISH) U	External glare full visor (specify finish)
RSXRPA (FINISH) U	RSX Universal round pole adaptor plate (specify finish)
RSXWBA (FINISH) U	RSX WBA wall bracket (specify finish) <sup>1</sup>
RSXSBCB (FINISH) U	RSX Surface conduit box (specify finish, for use with WBA, WBA not included)
DLL127F 1.5 JU	Photocell -SSL twist-lock (120-277V) <sup>19</sup>
DLL347F 1.5 CULJU	Photocell -SSL twist-lock (347V) <sup>19</sup>
DLL480F 1.5 CULJU	Photocell -SSL twist-lock (480V) <sup>19</sup>
DSHORT SBK U	Shorting cap <sup>19</sup>

### NOTES

- Any Type 5 distribution, is not available with WBA.
- MVOLT driver operates on any line voltage from 120-277V (50/60 Hz).
- HVOLT driver operates on any line voltage from 347-480V (50/60 Hz).
- XVOLT driver not available with P1. XVOLT driver operates on any line voltage from 277V-480V (50/60 Hz). XVOLT not available with fusing (SF or DF) and not available with PE or PEX.
- Single fuse (SF) requires 120V, 277V or 347V. Double fuse (DF) requires 208V, 240V or 480V.
- Maximum tilt is 90° above horizontal.
- It may be ordered as an accessory.
- Requires MVOLT or 347V.
- Not available in combination with other light sensing control options (following options cannot be combined: PE, PEX, PER7, FAO, DMG, DS, PIRHN). Exception: PE or PEX and FAO can be combined).
- Requires 120V, 208V, 240V, or 277V.

- Twistlock photocell ordered and shipped as a separate line item from Acuity Brands Controls. See accessories. Shorting Cap included. Dimming leads capped for future use.
- For units with option PER7, the mounting must be restricted to +/- 45° from horizontal aim per ANSI C136.10-2010.
- Two or more of the following options cannot be combined including DMG, DS, PER7, FAO and PIRHN.
- DS only available on performance package P5 and P6.
- Must be ordered with PIRHN.
- Requires MVOLT or HVOLT.
- Must be ordered with NLTAIR2. For additional information on PIRHN visit [here](#).
- Must be ordered with fixture for factory pre-drilling.
- Requires luminaire to be specified with PER7 option. Ordered and shipped as a separate line item from Acuity Brands Controls.

## External Shields



House Side Shield



External Glare Shield



External 360 Full Visor

## Pole/Mounting Information

Accessories including bullhorns, cross arms and other adapters are available under the accessories tab at Lithonia's Outdoor Poles and Arms product page. Click here to visit [Accessories](#).

### HANDHOLE ORIENTATION

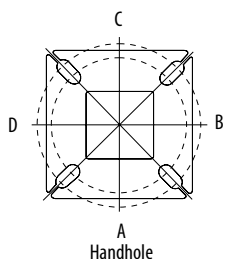

### RSX POLE DRILLING

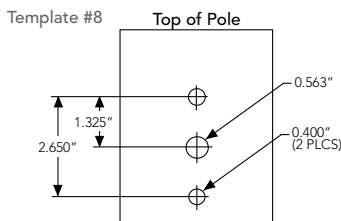

### RSX STANDARD ARM & ADJUSTABLE ARM

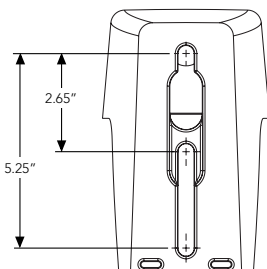

### Round Tenon Mount - Pole Top Slipfitters

Tenon O.D.	RSX Mounting	Single	2 at 180°	2 at 90°	3 at 120°	3 at 90°	4 at 90°
2 - 3/8"	RPA, AARP	AS3-5 190	AS3-5 280	AS3-5 290	AS3-5 320	AS3-5 390	AS3-5 490
2 - 7/8"	RPA, AARP	AST25-190	AST25-280	AST25-290	AST25-320	AST25-390	AST25-490
4"	RPA, AARP	AST35-190	AST35-280	AST35-290	AST35-320	AST35-390	AST35-490

### Drill/Side Location by Configuration Type

Drilling Template	Mounting Option	Single	2 @ 180	2 @ 90	3 @ 120	3 @ 90	4 @ 90
	Head Location	Side B	Side B & D	Side B & C	Round Pole Only	Side B, C & D	Side A, B, C & D
#8	Drill Nomenclature	DM19AS	DM28AS	DM29AS	DM32AS	DM39AS	DM49AS

### RSX2 - Luminaire EPA

\*Includes luminaire and integral mounting arm. Other tenons, arms, brackets or other accessories are not included in this EPA data.

Fixture Quantity & Mounting Configuration	Single	2 @ 90	2 @ 180	3 @ 90	3 @ 120	4 @ 90	2 Side by Side	3 Side by Side	4 Side by Side	
SPA - Square Pole Adaptor	0.69	1.22	1.27	1.8	1.61	2.39	1.37	2.06	2.74	
RPA - Round Pole Adaptor	0.74	1.27	1.37	1.9	1.71	2.49	1.42	2.16	2.84	
MA - Mast Arm Adaptor	0.61	1.14	1.11	1.64	1.45	2.23	1.29	1.9	2.58	
IS - Integral Slipfitter AASP/AARP - Adjustable Arm Square/Round Pole	0°	0.69	1.22	1.27	1.8	1.61	2.39	1.37	2.06	2.74
	10°	0.53	1.06	1.05	1.58	1.37	2.08	1.06	1.59	2.12
	20°	0.52	1.02	1.03	1.52	1.33	2.02	1.03	1.55	2.07
	30°	0.64	1.11	1.18	1.63	1.45	2.21	1.27	1.91	2.54
	40°	0.81	1.21	1.35	1.74	1.65	2.39	1.62	2.43	3.23
	45°	0.91	1.25	1.5	1.81	1.75	2.48	1.82	2.73	3.64
	50°	1.34	1.83	2.17	2.61	2.56	3.62	2.68	4.02	5.36
	60°	2.2	2.97	3.57	4.24	4.17	5.89	4.41	6.61	8.82
	70°	2.86	4.13	4.7	5.89	5.71	8.21	5.71	8.57	11.42
	80°	3.4	5.13	5.67	7.34	7.09	10.21	6.79	10.19	13.59
90°	3.85	5.96	6.55	8.58	8.31	11.88	7.70	11.56	15.41	

# Photometric Diagrams

To see complete photometric reports or download .ies files for this product, visit Lithonia Lighting's RSX Area homepage.

Isofootcandle plots for the RSX2 LED P6 40K. Distances are in units of mounting height (30').

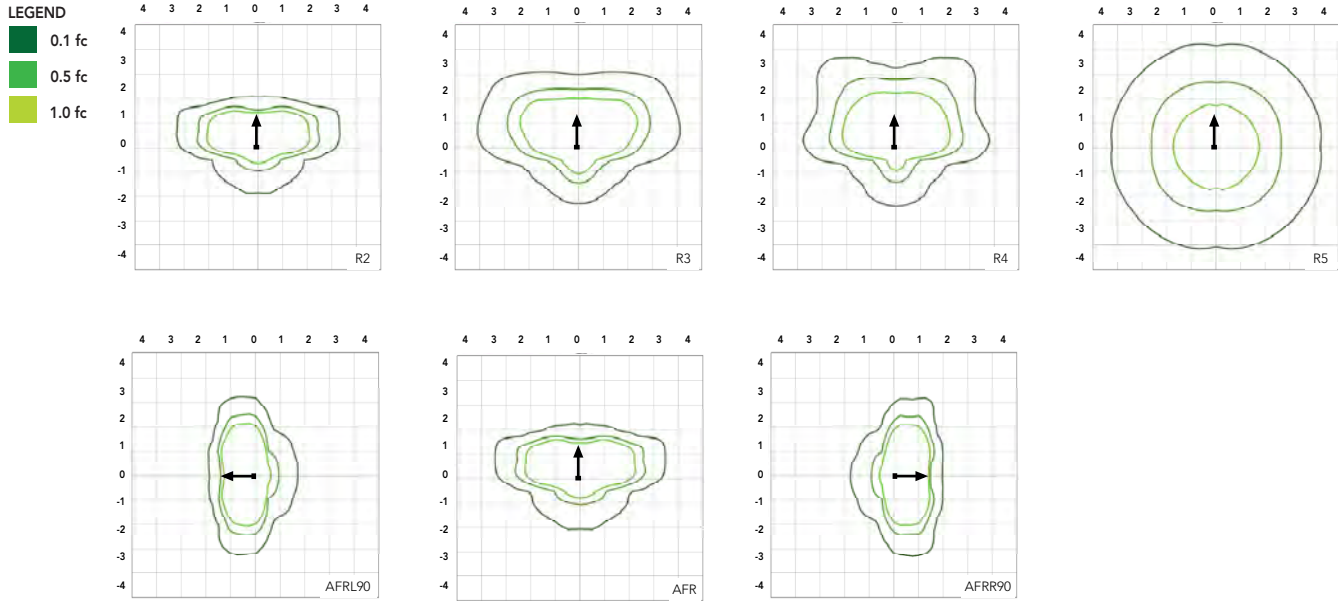

## Performance Data

### Lumen Ambient Temperature (LAT) Multipliers

Use these factors to determine relative lumen output for average ambient temperatures from 0-50°C (32-122°F).

Ambient	Ambient	Lumen Multiplier
0°C	32°F	1.05
5°C	41°F	1.04
10°C	50°F	1.03
15°C	59°F	1.02
20°C	68°F	1.01
25°C	77°F	1.00
30°C	86°F	0.99
35°C	95°F	0.98
40°C	104°F	0.97
45°C	113°F	0.96
50°C	122°F	0.95

### Electrical Load

Performance Package	System Watts (W)	Current (A)					
		120V	208V	240V	277V	347V	480V
P1	71W	0.59	0.34	0.30	0.26	0.20	0.15
P2	111W	0.93	0.53	0.46	0.40	0.32	0.23
P3	147W	1.23	0.70	0.61	0.53	0.42	0.31
P4	187W	1.55	0.90	0.78	0.68	0.53	0.38
P5	210W	1.75	1.01	0.87	0.76	0.60	0.44
P6	244W	2.03	1.17	1.01	0.88	0.70	0.51

### Projected LED Lumen Maintenance

Operating Hours	50,000	75,000	100,000
Lumen Maintenance Factor	>0.97	>0.95	>0.92

Values calculated according to IESNA TM-21-11 methodology and valid up to 40°C.

Lumen Output

Lumen values are from photometric tests performed in accordance with IESNA LM-79-08. Data is considered to be representative of the configurations shown, within the tolerances allowed by Lighting Facts. Contact factory for performance data on any configurations not shown here.

Performance Package	System Watts	Distribution Type	30K (3000K, 70 CRI)					40K (4000K, 70 CRI)					50K (5000K, 70 CRI)				
			Lumens	B	U	G	LPW	Lumens	B	U	G	LPW	Lumens	B	U	G	LPW
P1	71W	R2	10,040	2	0	1	139	11,031	2	0	1	153	11,031	2	0	1	153
		R3	10,005	2	0	2	141	10,992	2	0	2	155	10,992	2	0	2	155
		R3S	10,271	2	0	2	143	11,285	2	0	2	157	11,285	2	0	2	157
		R4	10,136	2	0	2	143	11,136	2	0	2	157	11,136	2	0	2	157
		R4S	9,779	2	0	2	138	10,744	2	0	2	151	10,744	2	0	2	151
		R5	10,271	4	0	2	145	11,285	4	0	2	159	11,285	4	0	2	159
		R5S	10,544	3	0	1	149	11,585	3	0	2	163	11,585	3	0	2	163
		AFR	10,026	2	0	1	141	11,016	2	0	1	155	11,016	2	0	1	155
		AFRR90	10,122	3	0	2	140	11,121	3	0	2	154	11,121	3	0	2	154
		AFRL90	10,164	3	0	2	141	11,167	3	0	2	155	11,167	3	0	2	155
P2	111W	R2	15,712	2	0	2	138	17,263	2	0	2	151	17,263	2	0	2	151
		R3	15,657	2	0	3	141	17,202	3	0	3	155	17,202	3	0	3	155
		R3S	16,075	2	0	2	141	17,661	2	0	2	155	17,661	2	0	2	155
		R4	15,862	2	0	3	143	17,427	2	0	3	157	17,427	2	0	3	157
		R4S	15,304	2	0	2	138	16,815	2	0	2	151	16,815	2	0	2	151
		R5	16,075	4	0	2	145	17,661	5	0	3	159	17,661	5	0	3	159
		R5S	16,502	4	0	2	149	18,130	4	0	2	163	18,130	4	0	2	163
		AFR	15,691	2	0	2	141	17,240	2	0	2	155	17,240	2	0	2	155
		AFRR90	15,841	3	0	3	139	17,404	4	0	3	153	17,404	4	0	3	153
		AFRL90	15,907	3	0	3	139	17,477	4	0	3	153	17,477	4	0	3	153
P3	147W	R2	19,855	3	0	2	132	21,814	3	0	2	145	21,814	3	0	2	145
		R3	19,785	3	0	3	135	21,737	3	0	4	148	21,737	3	0	4	148
		R3S	20,312	3	0	3	135	22,317	3	0	3	149	22,317	3	0	3	149
		R4	20,044	3	0	3	136	22,022	3	0	4	150	22,022	3	0	4	150
		R4S	19,339	3	0	3	132	21,247	3	0	3	145	21,247	3	0	3	145
		R5	20,313	5	0	3	138	22,317	5	0	3	152	22,317	5	0	3	152
		R5S	20,852	4	0	2	142	22,910	4	0	2	156	22,910	4	0	2	156
		AFR	19,828	3	0	2	135	21,785	3	0	2	148	21,785	3	0	2	148
		AFRR90	20,017	4	0	3	133	21,992	4	0	3	147	21,992	4	0	3	147
		AFRL90	20,101	4	0	3	134	22,084	4	0	3	147	22,084	4	0	3	147
P4	187W	R2	22,836	3	0	2	120	25,090	3	0	2	132	25,090	3	0	2	132
		R3	22,756	3	0	4	122	25,002	3	0	4	134	25,002	3	0	4	134
		R3S	23,363	3	0	3	123	25,668	3	0	3	135	25,668	3	0	3	135
		R4	23,054	3	0	4	123	25,329	3	0	4	135	25,329	3	0	4	135
		R4S	22,243	3	0	3	119	25,059	3	0	3	134	25,059	3	0	3	134
		R5	23,363	5	0	3	125	25,669	5	0	4	137	25,669	5	0	4	137
		R5S	23,983	4	0	2	128	26,350	4	0	2	141	26,350	4	0	2	141
		AFR	22,806	3	0	2	122	25,056	3	0	2	134	25,056	3	0	2	134
		AFRR90	23,023	4	0	3	121	25,295	4	0	3	133	25,295	4	0	3	133
		AFRL90	23,120	4	0	3	122	25,401	4	0	3	134	25,401	4	0	3	134
P5	210W	R2	26,141	3	0	2	122	28,721	3	0	2	135	28,721	3	0	2	135
		R3	26,049	3	0	4	124	28,620	3	0	4	136	28,620	3	0	4	136
		R3S	26,744	3	0	3	125	29,383	3	0	4	138	29,383	3	0	4	138
		R4	26,390	3	0	4	126	28,994	3	0	4	138	28,994	3	0	4	138
		R4S	25,462	3	0	3	121	27,974	3	0	3	133	27,974	3	0	3	133
		R5	26,744	5	0	4	127	29,383	5	0	4	140	29,383	5	0	4	140
		R5S	27,454	4	0	2	131	30,163	4	0	2	144	30,163	4	0	2	144
		AFR	26,106	3	0	2	124	28,682	3	0	2	137	28,682	3	0	2	137
		AFRR90	26,354	4	0	3	123	28,955	5	0	3	136	28,955	5	0	3	136
		AFRL90	26,465	4	0	3	124	29,077	5	0	3	136	29,077	5	0	3	136
P6	244W	R2	27,646	3	0	2	112	30,374	3	0	2	123	30,374	3	0	2	123
		R3	27,549	3	0	4	113	30,267	3	0	4	124	30,267	3	0	4	124
		R3S	28,283	3	0	3	115	31,075	3	0	4	126	31,075	3	0	4	126
		R4	27,909	3	0	4	114	30,663	3	0	4	126	30,663	3	0	4	126
		R4S	26,928	3	0	3	110	29,585	3	0	3	121	29,585	3	0	3	121
		R5	28,284	5	0	4	116	31,075	5	0	4	127	31,075	5	0	4	127
		R5S	29,035	4	0	2	119	31,900	5	0	3	131	31,900	5	0	3	131
		AFR	27,608	3	0	2	112	30,332	3	0	2	123	30,332	3	0	2	123
		AFRR90	27,872	4	0	3	113	30,622	5	0	3	124	30,622	5	0	3	124
		AFRL90	27,989	4	0	3	113	30,751	5	0	3	125	30,751	5	0	3	125

## Dimensions & Weights

### Luminaire Weight by Mounting Type

Mounting Configuration	Total Luminaire Weight
SPA	30 lbs
RPA	32 lbs
MA	30 lbs
WBA	33 lbs
WBASC	36 lbs
IS	33 lbs
AASP	33 lbs
AARP	35 lbs
AAWB	36 lbs
AAWSC	39 lbs

### RSX2 with Round Pole Adapter (RPA)

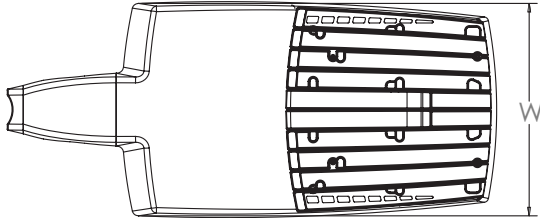

Length: 30.3" (77.0 cm)  
 Width: 13.4" (34.0 cm)  
 Height: 3.0" (7.6 cm) Main Body  
 7.2" (18.3 cm) Arm

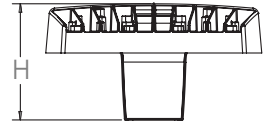
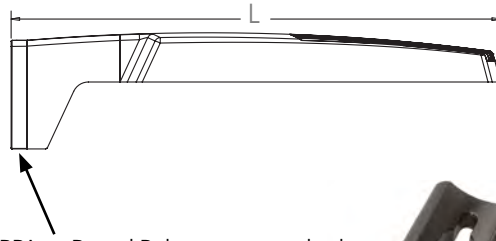

Note: RPA — Round Pole mount can also be used to mount on square poles by omitting the round pole adapter plate shown here.



### RSX2 with Mast Arm Adapter (MA)

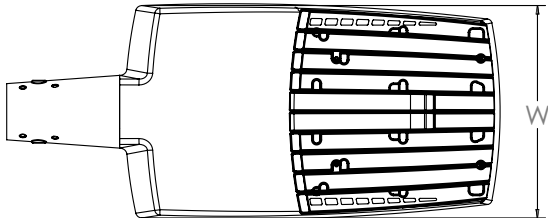

Length: 30.6" (77.7 cm)  
 Width: 13.4" (34.0 cm)  
 Height: 3.0" (7.6 cm) Main Body  
 3.5" (8.9 cm) Arm

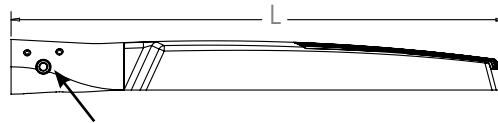

7/16" locking thru bolt/nut provided



### RSX2 with Adjustable Slipfitter (IS)

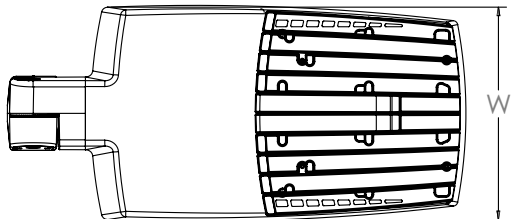

Length: 28.3" (71.9 cm)  
 Width: 13.4" (34.0 cm)  
 Height: 3.0" (7.6 cm) Main Body  
 7.6" (19.3 cm) Arm

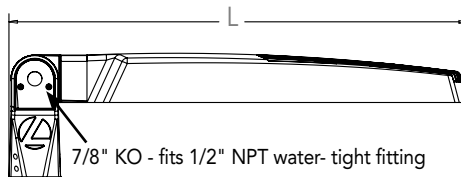

7/8" KO - fits 1/2" NPT water-tight fitting

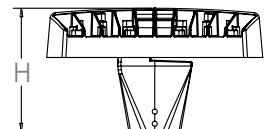

## Dimensions

### RSX2 with Wall Bracket (WBA)

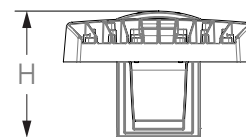
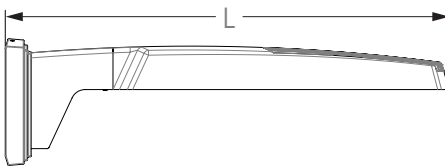
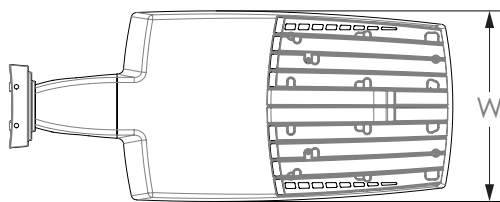

Length: 31.2" (79.2 cm)  
 Width: 13.4" (41.7 cm)  
 Height: 3.0" (7.6 cm) Main Body  
 8.9" (22.6 cm) Arm

#### Wall Bracket (WBA) Mounting Detail

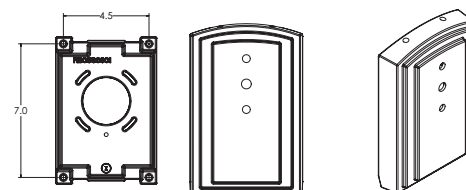

### RSX2 with Wall Bracket with Surface Conduit Box (WBASC)

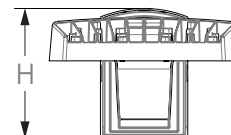
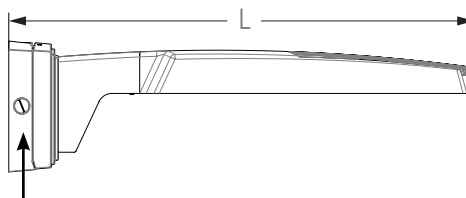
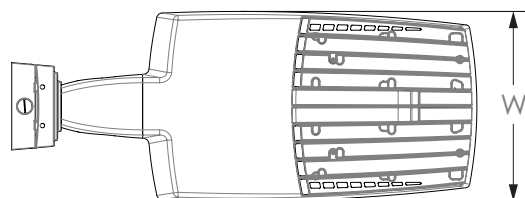

3/4" NPT taps with plugs - Qty (4) provided

Length: 32.8" (83.3 cm)  
 Width: 13.4" (41.7 cm)  
 Height: 3.0" (7.6 cm) Main Body  
 9.2" (23.4 cm) Arm

#### Surface Conduit Box (SCB) Mounting Detail

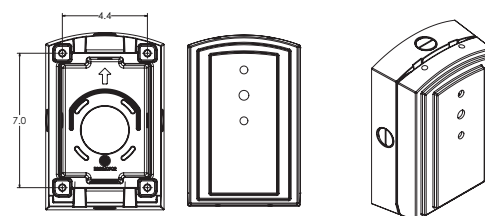



## Dimensions

### RSX2 with Adjustable Tilt Arm - Square or Round Pole (AASP or AARP)

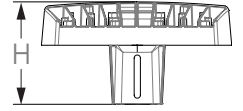
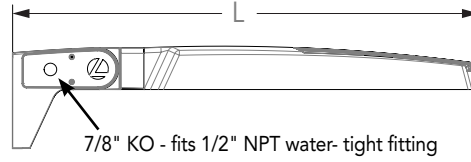
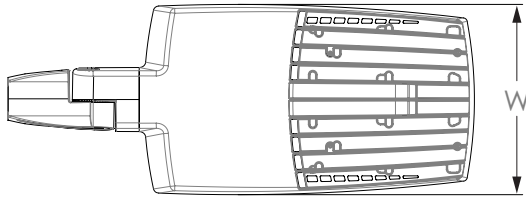

Length: 32.8" (83.3 cm) **AASP**  
 33.8" (85.9 cm) **AARP**  
 Width: 13.4" (34.0 cm)  
 Height: 3.0" (7.6 cm) Main Body  
 7.2" (18.2 cm) Arm

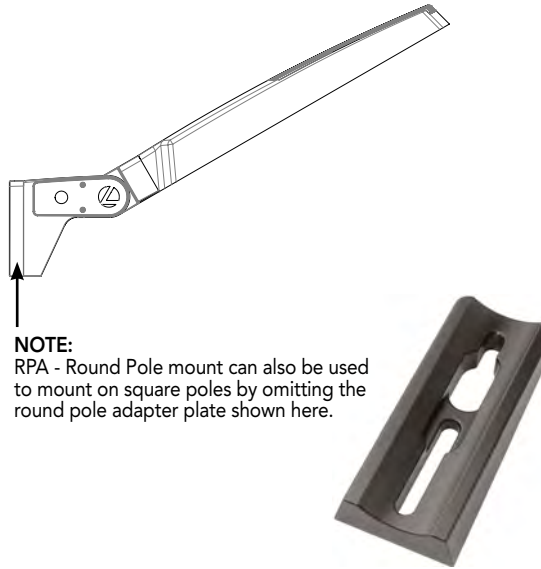

**NOTE:**  
 RPA - Round Pole mount can also be used to mount on square poles by omitting the round pole adapter plate shown here.

#### Notes

AASP: Requires 3.0" min. square pole for 1 at 90°. Requires 3.5" min. square pole for mounting 2, 3, 4 at 90°.

AARP: Requires 3.2" min. dia. round pole for 2, 3, 4 at 90°. Requires 3.0" min. dia. round pole for mounting 1 at 90°, 2 at 180°, 3 at 120°.

### RSX2 with Adjustable Tilt Arm with Wall Bracket (AAWB)

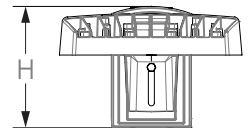
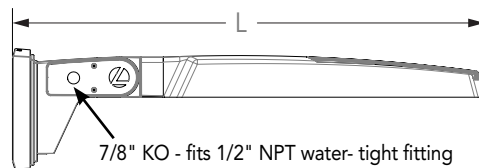
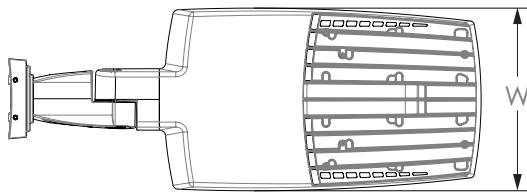

Length: 34.7" (88.0 cm)  
 Width: 13.4" (34.0 cm)  
 Height: 3.0" (7.6 cm) Main Body  
 8.9" (22.6 cm) Arm

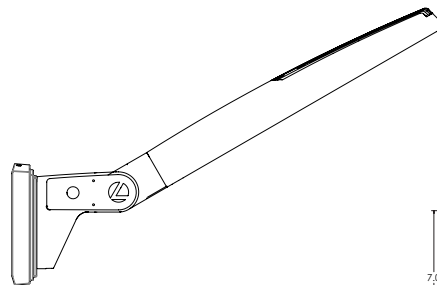

#### Wall Bracket (WBA) Mounting Detail

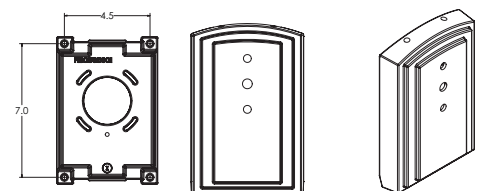

## Dimensions

### RSX2 with Adjustable Tilt Arm with Wall Bracket and Surface Conduit Box (AAWSC)

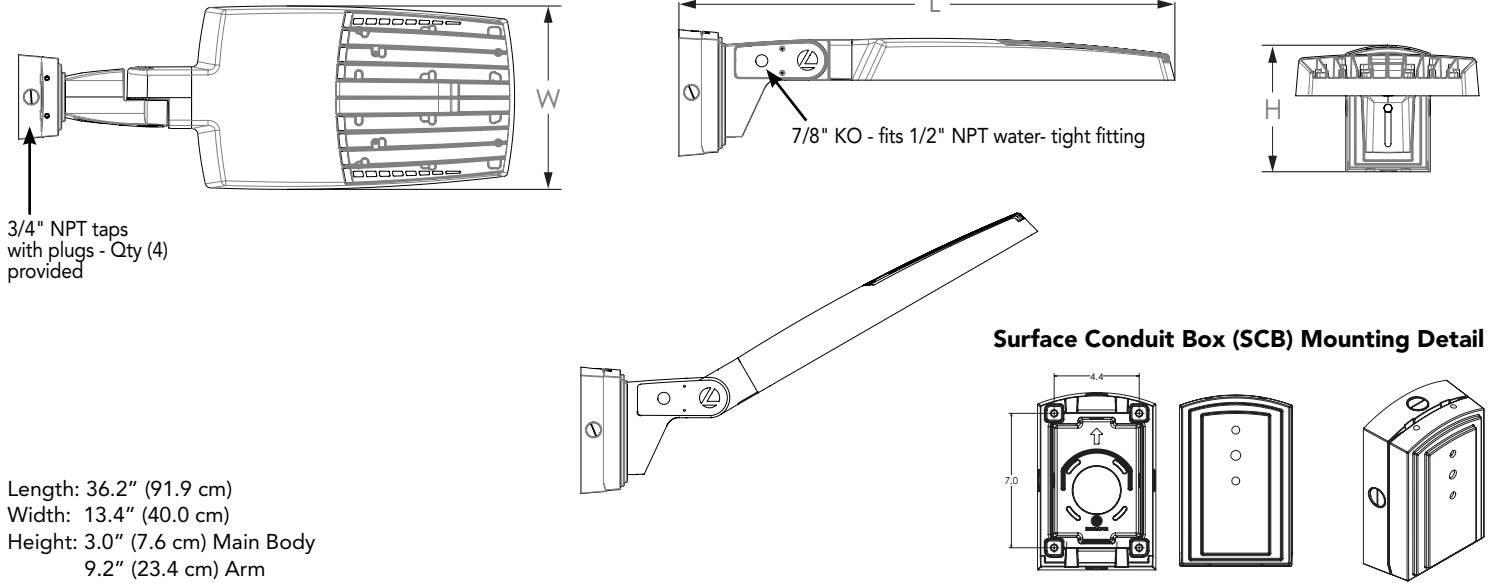

### Additional Reference Drawings

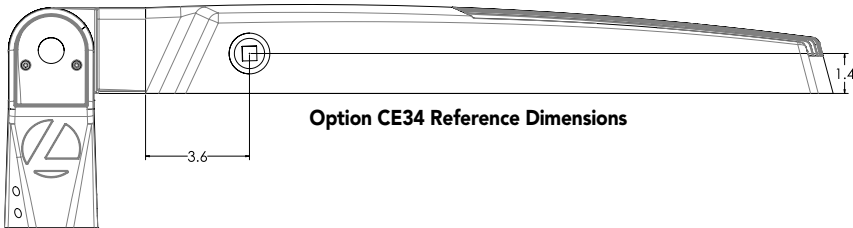

### Automotive Front Row - Rotated Optics (AFRL90/R90)

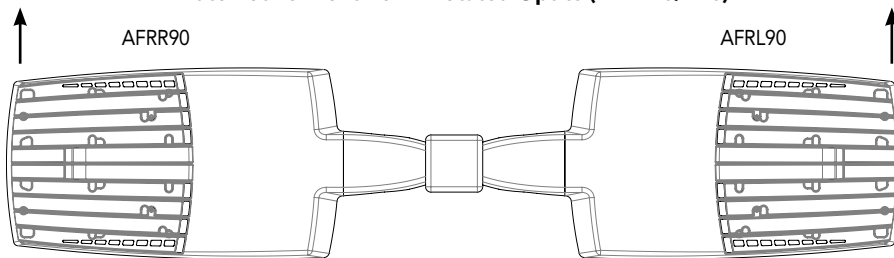

(Example: 2@180 - arrows indicate direction of light exiting the luminaire)

## NLTAIR2 PIRHN nLight Sensor Coverage Pattern nLight PIRHN

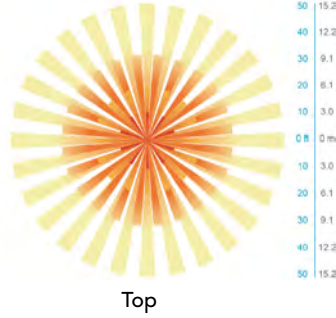
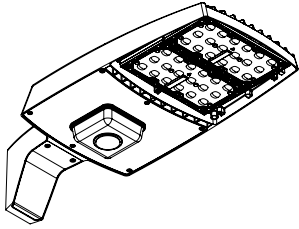

Motion Sensor Default Settings - Option PIRHN						
Option	Dimmed State (unoccupied)	High Level (when occupied)	Photocell Operation	Dwell Time (occupancy time delay)	Ramp-up Time (from unoccupied to occupied)	Ramp-down Time (from occupied to unoccupied)
NLTAIR2 PIRHN	Approx. 30% Output	100% Output	Enabled @ 1.5FC	7.5 minutes	3 seconds	5 minutes

\*Note: NLTAIR2 PIRHN default settings including photocell set-point, high/low dim rates, and occupancy sensor time delay are all configurable using the Clarity Pro App. Sensor coverage pattern shown with luminaire at 0°. Sensor coverage pattern is affected when luminaire is tilted.

## FEATURES & SPECIFICATIONS

### INTENDED USE

The RSX LED area family is designed to provide a long-lasting, energy-efficient solution for the one-for-one replacement of existing metal halide or high pressure sodium lighting. The RSX2 delivers 11,000 to 31,000 lumens and is ideal for replacing 250W to 1000W HID pole-mounted luminaires in parking lots and other area lighting applications.

### CONSTRUCTION AND DESIGN

The RSX LED area luminaire features a rugged die-cast aluminum main body that uses heat-dissipating fins and flow-through venting to provide optimal thermal management that both enhances LED performance and extends component life. Integral "no drill" mounting arm allows the luminaire to be mounted on existing pole drillings, greatly reducing installation labor. The light engines and housing are sealed against moisture and environmental contaminants to IP66. The low-profile design results in a low EPA, allowing pole optimization. Vibration rated per ANSI C136.31: 3G Mountings: Include SPA, RPA, MA, IS, AASP, AARP rated for 3G vibration. 1.5G Mountings: Include WBA, WBASC, AAWB and AAWSC rated for 1.5G vibration.

### FINISH

Exterior parts are protected by a zinc-infused Super Durable TGIC thermoset powder coat finish that provides superior resistance to corrosion and weathering. A tightly controlled multi-stage process ensures superior adhesion as well as a minimum finish thickness of 3 mils. The result is a high-quality finish that is warrantied not to crack or peel.

### OPTICS

Precision acrylic refractive lenses are engineered for superior application efficiency, distributing the light to where it is needed most. Available in short and wide pattern distributions including Type 2, Type 3, Type 3S, Type 4, Type 4S, Type 5, Type 5S, AFR (Automotive Front Row) and AFR rotated AFRR90 and ARFL90.

### ELECTRICAL

Light engine(s) configurations consist of high-efficacy LEDs mounted on metal-core circuit boards and aluminum heat sinks to maximize heat dissipation. Light engines are IP66 rated. LED lumen maintenance is >L92/100,000 hours. CCT's of 3000K, 4000K and 5000K (minimum 70 CRI) are available. Fixtures ship standard with 0-10v dimming driver. Class 1 electronic drivers ensure system power factor >90% and THD <20%. Easily serviceable 10kV surge protection device meets a minimum Category C Low operation (per ANSI/IEEE C62.41.2).

### STANDARD CONTROLS

The RSX LED area luminaire has a wide assortment of control options. Dusk to dawn controls include MVOLT and 347V button-type photocells and NEMA twist-lock photocell receptacles.

### nLIGHT AIR CONTROLS

The RSX LED area luminaire is also available with nLight® AIR for the ultimate in wireless control. This powerful controls platform provides out-of-the-box basic motion sensing with photocell functionality and is suitable for mounting heights up to 40 feet. No commissioning is required when using factory default settings that provide basic stand-alone motion occupancy dimming that is switched on and off with a built-in photocell. See chart above for motion sensor default out-of-box settings. For more advanced wireless functionality, such as group dimming, nLight AIR can be commissioned using a smartphone and the easy-to-use CLAIRITY app. nLight AIR equipped luminaires can be grouped, resulting in motion sensor and photocell group response without the need for additional equipment. Scheduled dimming with motion sensor over-ride can be achieved when used with the nLight Eclipse. Additional information about nLight Air can be found [here](#).

### INSTALLATION

Integral "no-drill" mounting arm allows for fast, easy mounting using existing pole drillings. Select the "SPA" option for square poles and the "RPA" option to mount to round poles. Note, the RPA mount can also be used for mounting to square poles by omitting the RPA adapter plate. Select the "MA" option to attach the luminaire to a 2 3/8" horizontal mast arm or the "IS" option for an adjustable slipfitter that mounts on a 2 3/8" OD tenon. The adjustable slipfitter has an integral junction box and offers easy installation. Can be tilted up to 90° above horizontal. Additional mountings are available including a wall bracket, adjustable tilt arm for direct-to-pole and wall and a surface conduit box for wall mount applications.

### LISTINGS

CSA Certified to meet U.S. and Canadian standards. Suitable for wet locations. Rated for -40°C minimum ambient. DesignLights Consortium® (DLC) Premium qualified product and DLC qualified product. Not all versions of this product may be DLC Premium qualified or DLC qualified. Please check the DLC Qualified Products List at [www.designlights.org/QPL](http://www.designlights.org/QPL) to confirm which versions are qualified.

International Dark-Sky Association (IDA) Fixture Seal of Approval (FSA) is available for all products on this page utilizing 3000K color temperature only. US Patent No. D882, 146S

### BUY AMERICAN ACT

Product with the BAA option is assembled in the USA and meets the Buy America(n) government procurement requirements under FAR, DFARS and DOT regulations. Please refer to [www.acuitybrands.com/buy-american](http://www.acuitybrands.com/buy-american) for additional information.

### WARRANTY

5-year limited warranty. This is the only warranty provided and no other statements in this specification sheet create any warranty of any kind. All other express and implied warranties are disclaimed. Complete warranty terms located at:

[www.acuitybrands.com/support/warranty/terms-and-conditions](http://www.acuitybrands.com/support/warranty/terms-and-conditions)

**Note:** Actual performance may differ as a result of end-user environment and application. All values are design or typical values, measured under laboratory conditions at 25 °C. Specifications subject to change without notice.



# WDGE2 LED

## Architectural Wall Sconce

### Precision Refractive Optic



Catalog Number

Notes

Type

Hit the Tab key or mouse over the page to see all interactive elements.

### Specifications

- Depth (D1):** 7"
- Depth (D2):** 1.5"
- Height:** 9"
- Width:** 11.5"
- Weight:** 13.5 lbs  
(without options)

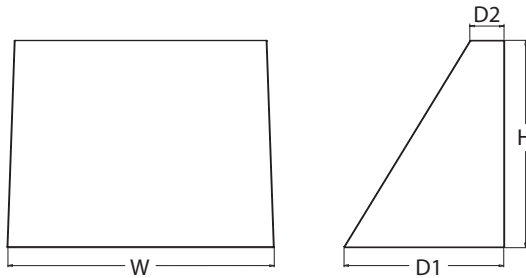

### Introduction

The WDGE LED family is designed to meet specifier's every wall-mounted lighting need in a widely accepted shape that blends with any architecture. The clean rectilinear design comes in four sizes with lumen packages ranging from 1,200 to 25,000 lumens, providing a true site-wide solution. Embedded with nLight® AIR wireless controls, the WDGE family provides additional energy savings and code compliance.

WDGE2 with industry leading precision refractive optics provides great uniform distribution and optical control. When combined with multiple integrated emergency battery backup options, including an 18W cold temperature option, the WDGE2 becomes the ideal wall-mounted lighting solution for pedestrian scale applications in any environment.

### WDGE LED Family Overview

Luminaire	Optics	Standard EM, 0°C	Cold EM, -20°C	Sensor	Approximate Lumens (4000K, 80CRI)						
					P0	P1	P2	P3	P4	P5	P6
WDGE1 LED	Visual Comfort	4W		--	750	1,200	2,000	--	--	--	--
WDGE2 LED	Visual Comfort	10W	18W	Standalone / nLight	--	1,200	2,000	3,000	4,500	6,000	--
WDGE2 LED	Precision Refractive	10W	18W	Standalone / nLight	700	1,200	2,000	3,200	4,200	--	--
WDGE3 LED	Precision Refractive	15W	18W	Standalone / nLight	--	7,500	8,500	10,000	12,000	--	--
WDGE4 LED	Precision Refractive			Standalone / nLight	--	12,000	16,000	18,000	20,000	22,000	25,000

### Ordering Information

**EXAMPLE: WDGE2 LED P3 40K 80CRI VF MVOLT SRM DDBXD**

Series	Package	Color Temperature	CRI	Distribution	Voltage	Mounting
WDGE2 LED	P0 <sup>1</sup> P1 <sup>2</sup> P2 <sup>2</sup> P3 <sup>2</sup> P4 <sup>2</sup>	27K 2700K 30K 3000K 40K 4000K 50K 5000K AMB <sup>3</sup> Amber	70CRI <sup>4</sup> 80CRI LW <sup>3</sup> Limited Wavelength	T1S Type I Short T2M Type II Medium T3M Type III Medium T4M Type IV Medium TFTM Forward Throw Medium	MVOLT 347 <sup>5</sup> 480 <sup>5</sup>	<b>Shipped included</b> SRM Surface mounting bracket ICW Indirect Canopy/Ceiling Washer bracket (dry/damp locations only) <sup>6</sup> <b>Shipped separately</b> AWS 3/8inch Architectural wall spacer PBBW Surface-mounted back box (top, left, right conduit entry). Use when there is no junction box available.

Options	Finish
<b>E10WH</b> Emergency battery backup, Certified in CA Title 20 MAEDBS (10W, 5°C min) <b>E20WC</b> Emergency battery backup, Certified in CA Title 20 MAEDBS (18W, -20°C min) <b>PE<sup>7</sup></b> Photocell, Button Type <b>DMG<sup>8</sup></b> 0-10V dimming wires pulled outside fixture (for use with an external control, ordered separately) <b>BCE</b> Bottom conduit entry for back box (PBBW). Total of 4 entry points. <b>BAA</b> Buy America(n) Act Compliant	<b>DDBXD</b> Dark bronze <b>DBLXD</b> Black <b>DNAXD</b> Natural aluminum <b>DWHXD</b> White <b>DSSXD</b> Sandstone <b>DBBTXD</b> Textured dark bronze <b>DBL BXD</b> Textured black <b>DNATXD</b> Textured natural aluminum <b>DWHGXD</b> Textured white <b>DSSTXD</b> Textured sandstone
<b>Standalone Sensors/Controls</b> <b>PIR</b> Bi-level (100/35%) motion sensor for 8-15' mounting heights. Intended for use on switched circuits with external dusk to dawn switching. <b>PIRH</b> Bi-level (100/35%) motion sensor for 15-30' mounting heights. Intended for use on switched circuits with external dusk to dawn switching <b>PIR1FC3V</b> Bi-level (100/35%) motion sensor for 8-15' mounting heights with photocell pre-programmed for dusk to dawn operation. <b>PIRH1FC3V</b> Bi-level (100/35%) motion sensor for 15-30' mounting heights with photocell pre-programmed for dusk to dawn operation. <b>Networked Sensors/Controls</b> <b>NLTAIR2 PIR</b> nLightAIR Wireless enabled bi-level motion/ambient sensor for 8-15' mounting heights. <b>NLTAIR2 PIRH</b> nLightAIR Wireless enabled bi-level motion/ambient sensor for 15-30' mounting heights. See page 4 for out of box functionality	



COMMERCIAL OUTDOOR

One Lithonia Way • Conyers, Georgia 30012 • Phone: 1-800-705-SERV (7378) • [www.lithonia.com](http://www.lithonia.com)  
 © 2019-2022 Acuity Brands Lighting, Inc. All rights reserved.

WDGE2 LED  
 Rev. 11/21/22

## Accessories

Ordered and shipped separately.

WDGEAWS DDBXD W DGE 3/8inch Architectural Wall Spacer (specify finish)  
 WDGE2P8BW DDBXD U W DGE2 surface-mounted back box (specify finish)

### NOTES

- 1 PO option not available with sensors/controls.
- 2 P1-P4 not available with AMB and LW.
- 3 AMB and LW always go together.
- 4 70CRI only available with T3M and T4M.
- 5 347V and 480V not available with E10WH or E20WC.
- 6 Not qualified for DLC. Not available with emergency battery backup or sensors/controls.
- 7 PE not available in 480V or with sensors/controls.
- 8 DMG option not available with sensors/controls.

## Performance Data

### Lumen Output

Lumen values are from photometric tests performed in accordance with IESNA LM-79-08. Data is considered to be representative of the configurations shown, within the tolerances allowed by Lighting Facts. Contact factory for performance data on any configurations not shown here.

Performance Package	System Watts	Dist. Type	27K (2700K, 80 CRI)					30K (3000K, 80 CRI)					40K (4000K, 80 CRI)					50K (5000K, 80 CRI)					Amber (Limited Wavelength)				
			Lumens	LPW	B	U	G	Lumens	LPW	B	U	G	Lumens	LPW	B	U	G	Lumens	LPW	B	U	G	Lumens	LPW	B	U	G
P0	7W	T1S	636	92	0	0	0	666	97	0	0	0	699	101	0	0	1	691	100	0	0	1	712	47	0	0	1
		T2M	662	96	0	0	0	693	101	0	0	0	728	106	0	0	0	719	104	0	0	0	741	48	0	0	0
		T3M	662	96	0	0	0	693	101	0	0	0	728	106	0	0	0	719	104	0	0	0	741	48	0	0	0
		T4M	648	94	0	0	0	679	98	0	0	0	712	103	0	0	0	704	102	0	0	0	726	47	0	0	0
		TFTM	652	95	0	0	0	683	99	0	0	0	717	104	0	0	0	708	103	0	0	0	730	48	0	0	1
P1	11W	T1S	1,105	99	0	0	1	1,157	104	0	0	1	1,215	109	0	0	1	1,200	107	0	0	1					
		T2M	1,150	103	0	0	1	1,204	108	0	0	1	1,264	113	0	0	1	1,249	112	0	0	1					
		T3M	1,150	103	0	0	1	1,205	108	0	0	1	1,265	113	0	0	1	1,250	112	0	0	1					
		T4M	1,126	101	0	0	1	1,179	106	0	0	1	1,238	111	0	0	1	1,223	110	0	0	1					
		TFTM	1,133	101	0	0	1	1,186	106	0	0	1	1,245	112	0	0	1	1,230	110	0	0	1					
P2	19W	T1S	1,801	95	1	0	1	1,886	99	1	0	1	1,981	104	1	0	1	1,957	103	1	0	1					
		T2M	1,875	99	1	0	1	1,963	103	1	0	1	2,061	109	1	0	1	2,037	107	1	0	1					
		T3M	1,876	99	1	0	1	1,964	103	1	0	1	2,062	109	1	0	1	2,038	107	1	0	1					
		T4M	1,836	97	1	0	1	1,922	101	1	0	1	2,018	106	1	0	1	1,994	105	1	0	1					
		TFTM	1,847	97	1	0	1	1,934	102	1	0	1	2,030	107	1	0	1	2,006	106	1	0	1					
P3	32W	T1S	2,809	87	1	0	1	2,942	92	1	0	1	3,089	96	1	0	1	3,052	95	1	0	1					
		T2M	2,924	91	1	0	1	3,062	95	1	0	1	3,215	100	1	0	1	3,176	99	1	0	1					
		T3M	2,925	91	1	0	1	3,063	95	1	0	1	3,216	100	1	0	1	3,177	99	1	0	1					
		T4M	2,862	89	1	0	1	2,997	93	1	0	1	3,147	98	1	0	1	3,110	97	1	0	1					
		TFTM	2,880	90	1	0	1	3,015	94	1	0	1	3,166	99	1	0	1	3,128	97	1	0	1					
P4	47W	T1S	3,729	80	1	0	1	3,904	84	1	0	1	4,099	88	1	0	1	4,051	87	1	0	1					
		T2M	3,881	83	1	0	1	4,063	87	1	0	1	4,267	91	1	0	1	4,216	90	1	0	1					
		T3M	3,882	83	1	0	1	4,065	87	1	0	1	4,268	91	1	0	1	4,217	90	1	0	1					
		T4M	3,799	81	1	0	1	3,978	85	1	0	1	4,177	90	1	0	1	4,127	88	1	0	1					
		TFTM	3,822	82	1	0	1	4,002	86	1	0	1	4,202	90	1	0	1	4,152	89	1	0	1					

Performance Package	System Watts	Dist. Type	27K (2700K, 70 CRI)					30K (3000K, 70 CRI)					40K (4000K, 70 CRI)					50K (5000K, 70 CRI)									
			Lumens	LPW	B	U	G	Lumens	LPW	B	U	G	Lumens	LPW	B	U	G	Lumens	LPW	B	U	G					
P0	7W	T3M	737	107	0	0	0	763	111	0	0	0	822	119	0	0	0	832	121	0	0	1					
		T4M	721	105	0	0	0	746	108	0	0	0	804	117	0	0	1	814	118	0	0	1					
P1	11W	T3M	1,280	115	0	0	1	1,325	119	0	0	1	1,427	128	1	0	1	1,445	129	1	0	1					
		T4M	1,253	112	0	0	1	1,297	116	0	0	1	1,397	125	0	0	1	1,415	127	0	0	1					
P2	19W	T3M	2,087	110	1	0	1	2,160	114	1	0	1	2,327	123	1	0	1	2,357	124	1	0	1					
		T4M	2,042	108	1	0	1	2,114	111	1	0	1	2,278	120	1	0	1	2,306	121	1	0	1					
P3	32W	T3M	3,254	101	1	0	1	3,369	105	1	0	1	3,629	113	1	0	1	3,675	114	1	0	1					
		T4M	3,185	99	1	0	1	3,297	103	1	0	1	3,552	111	1	0	1	3,597	112	1	0	1					
P4	47W	T3M	4,319	93	1	0	1	4,471	96	1	0	1	4,817	103	1	0	2	4,878	105	1	0	2					
		T4M	4,227	91	1	0	1	4,376	94	1	0	2	4,714	101	1	0	2	4,774	102	1	0	2					



## Electrical Load

Performance Package	System Watts	Current (A)					
		120Vac	208Vac	240Vac	277Vac	347Vac	480Vac
P0	7.0	0.061	0.042	0.04	0.039	--	--
	9.0	--	--	--	--	0.031	0.021
P1	11.0	0.100	0.064	0.059	0.054	--	--
	14.1	--	--	--	--	0.046	0.031
P2	19.0	0.168	0.106	0.095	0.083	--	--
	22.8	--	--	--	--	0.067	0.050
P3	32.0	0.284	0.163	0.144	0.131	--	--
	37.1	--	--	--	--	0.107	0.079
P4	47.0	0.412	0.234	0.207	0.185	--	--
	53.5	--	--	--	--	0.153	0.112

## Lumen Output in Emergency Mode (4000K, 80 CRI, T3M)

Option	Lumens
E10WH	1,358
E20WC	2,230

## Lumen Ambient Temperature (LAT) Multipliers

Use these factors to determine relative lumen output for average ambient temperatures from 0-40°C (32-104°F).

Ambient		Lumen Multiplier
0°C	32°F	1.03
10°C	50°F	1.02
20°C	68°F	1.01
25°C	77°F	1.00
30°C	86°F	0.99
40°C	104°F	0.97

## Projected LED Lumen Maintenance

Data references the extrapolated performance projections for the platforms noted in a 25°C ambient, based on 10,000 hours of LED testing (tested per IESNA LM-80-08 and projected per IESNA TM-21-11).

To calculate LLF, use the lumen maintenance factor that corresponds to the desired number of operating hours below. For other lumen maintenance values, contact factory.

Operating Hours	0	25,000	50,000	100,000
Lumen Maintenance Factor	1.0	>0.96	>0.93	>0.87

## Photometric Diagrams

To see complete photometric reports or download .ies files for this product, visit the Lithonia Lighting WDG2 LED homepage. Tested in accordance with IESNA LM-79 and LM-80 standards.

### LEGEND

<span style="color: yellow;">■</span>	0.25 fc
<span style="color: orange;">■</span>	0.5 fc
<span style="color: red;">■</span>	1.0 fc
<span style="color: darkred;">■</span>	3.0 fc

MH = 10ft  
Grid = 10ft x 10ft



## Emergency Egress Options

### Emergency Battery Backup

The emergency battery backup is integral to the luminaire — no external housing required! This design provides reliable emergency operation while maintaining the aesthetics of the product. All emergency battery backup configurations include an independent secondary driver with an integral relay to immediately detect loss of normal power and automatically energize the luminaire. The emergency battery will power the luminaire for a minimum duration of 90 minutes (maximum duration of three hours) from the time normal power is lost and maintain a minimum of 60% of the light output at the end of 90minutes.

Applicable codes: NFPA 70/NEC – section 700.16, NFPA 101 Life Safety Code Section 7.9

### Motion/Ambient Sensor (PIR\_, PIRH\_)

Motion/Ambient sensor (Sensor Switch MSOD) is integrated into the the luminaire. The sensor provides both Motion and Daylight based dimming of the luminaire. For motion detection, the sensor utilizes 100% Digital Passive Infrared (PIR) technology that is tuned for walking size motion while preventing false tripping from the environment. The integrated photocell enables additional energy savings during daytime periods when there is sufficient daylight. Optimize sensor coverage by either selecting PIR or PIRH option. PIR option comes with a sensor lens that is optimized to provide maximum coverage for mounting heights between 8-15ft, while PIRH is optimized for 15-40ft mounting height.

### Networked Control (NLTAIR2)

nLight® AIR is a wireless lighting controls platform that allows for seamless integration of both indoor and outdoor luminaires. Five-tier security architecture, 900 MHz wireless communication and app (CLAIRITY™ Pro) based configurability combined together make nLight® AIR a secure, reliable and easy to use platform.

#### PIR

##### HIGH VIEW

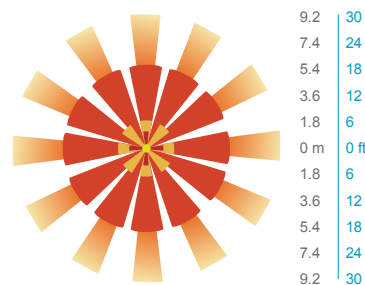
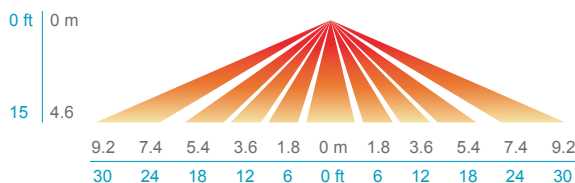

#### PIRH

##### SIDE VIEW

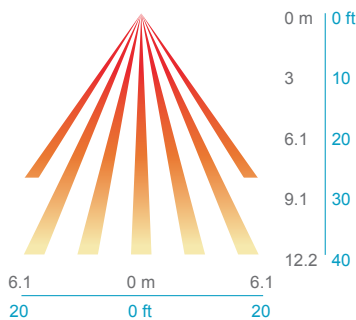

##### TOP VIEW

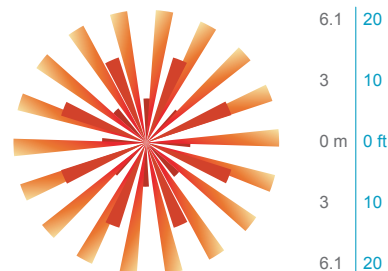

Option	Dim Level	High Level (when triggered)	Photocell Operation	Motion Time Delay	Ramp-down Time	Ramp-up Time
PIR or PIRH	Motion - 3V (37% of full output) Photocell - 0V (turned off)	10V (100% output)	Enabled @ 5fc	5 min	5 min	Motion - 3 sec Photocell - 45 sec
PIR1FC3V, PIRH1FC3V	Motion - 3V (37% of full output) Photocell - 0V (turned off)	10V (100% output)	Enabled @ 1fc	5 min	5 min	Motion - 3 sec Photocell - 45 sec
NLTAIR2 PIR, NLTAIR2 PIRH (out of box)	Motion - 3V (37% of full output) Photocell - 0V (turned off)	10V (100% output)	Enabled @ 5fc	7.5 min	5 min	Motion - 3 sec Photocell - 45 sec



### Motion/Ambient Sensor

D = 7"  
 H = 9" (Standalone controls)  
 11" (nLight AIR controls, 2" antenna will be pointing down behind the sensor)  
 W = 11.5"



### PBBW – Surface-Mounted Back Box Use when there is no junction box available.

D = 1.75"  
 H = 9"  
 W = 11.5"



### AWS – 3/8inch Architectural Wall Spacer

D = 0.38"  
 H = 4.4"  
 W = 7.5"

## FEATURES & SPECIFICATIONS

### INTENDED USE

Common architectural look, with clean rectilinear shape, of the WDGE LED was designed to blend with any type of construction, whether it be tilt-up, frame or brick. Applications include commercial offices, warehouses, hospitals, schools, malls, restaurants, and other commercial buildings.

### CONSTRUCTION

The single-piece die-cast aluminum housing integrates secondary heat sinks to optimize thermal transfer from the internal light engine heat sinks and promote long life. The driver is mounted in direct contact with the casting for a low operating temperature and long life. The die-cast door frame is fully gasketed with a one-piece solid silicone gasket to keep out moisture and dust, providing an IP66 rating for the luminaire.

### FINISH

Exterior painted parts are protected by a zinc-infused Super Durable TGIC thermoset powder coat finish that provides superior resistance to corrosion and weathering. A tightly controlled multi-stage process ensures a 3 mils thickness for a finish that can withstand extreme climate changes without cracking or peeling. Standard Super Durable colors include dark bronze, black, natural aluminum, sandstone and white. Available in textured and non-textured finishes.

### OPTICS

Individually formed acrylic lenses are engineered for superior application efficiency which maximizes the light in the areas where it is most needed. The WDGE LED has zero uplight and qualifies as a Nighttime Friendly™ product, meaning it is consistent with the LEED® and Green Globes™ criteria for eliminating wasteful uplight.

### ELECTRICAL

Light engine consists of high-efficacy LEDs mounted to metal-core circuit boards to maximize heat dissipation and promote long life (up to L91/100,000 hours at 25°C). The electronic driver has a power factor of >90%, THD <20%. Luminaire comes with built in 6kV surge protection, which meets a minimum Category C low exposure (per ANSI/IEEE C62.41.2). Fixture ships standard with 0-10v dimmable driver.

### INSTALLATION

A universal mounting plate with integral mounting support arms allows the fixture to hinge down for easy access while making wiring connections. The 3/8" Architectural Wall Spacer (AWS) can be used to create a floating appearance or to accommodate small imperfections in the wall surface. The ICW option can be used to mount the luminaire inverted for indirect lighting in dry and damp locations. Design can withstand up to a 1.5 G vibration load rating per ANSI C136.31.

### LISTINGS

CSA certified to U.S. and Canadian standards. Luminaire is IP66 rated. PIR options are rated for wet location. Rated for -40°C minimum ambient. DesignLights Consortium® (DLC) Premium qualified product and DLC qualified product. Not all versions of this product may be DLC Premium qualified or DLC qualified. Please check the DLC Qualified Products List at [www.designlights.org/QPL](http://www.designlights.org/QPL) to confirm which versions are qualified. International Dark-Sky Association (IDA) Fixture Seal of Approval (FSA) is available for all products on this page utilizing 2700K and 3000K color temperature only and SRM mounting only.

### BUY AMERICAN ACT

Product with the BAA option is assembled in the USA and meets the Buy America(n) government procurement requirements under FAR, DFARS and DOT regulations. Please refer to [www.acuitybrands.com/buy-american](http://www.acuitybrands.com/buy-american) for additional information.

### WARRANTY

5-year limited warranty. This is the only warranty provided and no other statements in this specification sheet create any warranty of any kind. All other express and implied warranties are disclaimed. Complete warranty terms located at: [www.acuitybrands.com/support/warranty/terms-and-conditions](http://www.acuitybrands.com/support/warranty/terms-and-conditions)

**Note:** Actual performance may differ as a result of end-user environment and application. All values are design or typical values, measured under laboratory conditions at 25 °C. Specifications subject to change without notice.