



City of Lucas

Planning and Zoning Commission

June 10, 2021

7:00 PM

City Hall – Council Chambers and Video Conference
665 Country Club Road – Lucas, Texas

Notice is hereby given that a meeting of the Lucas Planning and Zoning Commission will be held on Thursday, June 10, 2021 at 7:00 pm at Lucas City Hall, 665 Country Club Road, Lucas, Texas 75002-7651 and by video conference, at which time the following agenda will be discussed. As authorized by Section 551.071 of the Texas Government Code, the Planning and Zoning Commission may convene into closed Executive Session for the purpose of seeking confidential legal advice from the City Attorney on any item on the agenda at any time during the meeting.

On March 16, 2020, Governor Abbott suspended some provisions of the Open Meetings Act in response to the COVID-19 emergency. Planning and Zoning meetings are also available through Zoom from your computer or smartphone. To join the meeting, please click this URL:

<https://zoom.us/s/92691972860?pwd=cWJxTnZGWW1hZDhDVIFNSXJwZFpTQT09> and enter your name and email address.

Join by phone: 1-346-248-7799

Webinar ID: 926 9197 2860

Passcode: 813188

If you would like to watch the meeting live, and not participate via Zoom, you may go to the City's live streaming link at <https://www.lucastexas.us/live-streaming-videos/>.

Call to Order

- Roll Call
- Determination of Quorum
- Reminder to turn off or silence cell phones
- Pledge of Allegiance

Regular Agenda

1. Consider approval of an application for a site plan, landscape plan, elevations, and final plat submitted by the property owner Bill Shipley on behalf of Tractor Supply for use as a commercial farm and garden retail center on a 5.56-acre tract of land in the William Snider Survey, Abstract Number 821, situated in the City of Lucas, Collin County, Texas, located at 495 South Angel Parkway. **(Development Services Director Joe Hilbourn)**
2. Review the City's submittal procedures and approval requirements relating to the platting process and provide direction to staff on any recommended amendments. **(Development Services Director Joe Hilbourn)**

3. Consider approval of the minutes of the May 13, 2021 Planning and Zoning Commission meeting. (City Secretary Stacy Henderson)

Executive Session Agenda

As authorized by Section 551.071 of the Texas Government Code, the Planning and Zoning Commission may convene into closed Executive Session for the purpose of seeking confidential legal advice from the City Attorney regarding any item on the agenda at any time during the meeting. This meeting is closed to the public as provided in the Texas Government Code.

4. Executive Session: An Executive Session is not scheduled for this meeting.
5. Adjournment.

Certification

I do hereby certify that the above notice was posted in accordance with the Texas Open Meetings Act on the bulletin board at Lucas City Hall, 665 Country Club Road, Lucas, Texas 75002 and on the City's website at www.lucastexas.us on or before 6:00 p.m. on June 4, 2021.

Stacy Henderson, City Secretary

In compliance with the American with Disabilities Act, the City of Lucas will provide for reasonable accommodations for persons attending public meetings at City Hall. Requests for accommodations or interpretive services should be directed to Stacy Henderson at 972-912-1211 or by email at shenderson@lucastexas.us at least 48 hours prior to the meeting.



City of Lucas

City Council Agenda Request

June 10, 2021

Item No. 01

Requester: Development Services Director Joe Hilbourn

Agenda Item Request

Consider approval of an application for a site plan, landscape plan, elevations, and final plat submitted by the property owner Bill Shipley on behalf of Tractor Supply for use as a commercial farm and garden retail center on a 5.56-acre tract of land in the William Snider Survey, Abstract Number 821, situated in the City of Lucas, Collin County, Texas, located at 495 South Angel Parkway.

Background Information

Site Plan:

Tractor Supply is proposing 21,930 square feet of retail space with outside storage. The outside storage does require a specific use permit that was approved by the Planning and Zoning Commission on May 13, 2021. The site is currently zoned Commercial Business, and the use fits the area. Impervious cover shown is 61% (a maximum of 65% is permitted). Parking spaces required is 110 (120 are proposed). Site stormwater runoff detention is accounted for and shown, and all drainage is dedicated as a drainage easement for protection. The site does meet the City's lighting requirements and the photometric plan that was submitted.

Landscape Plan:

Total site area is 242,217 square feet and the building footprint is 21,930 square feet. Total landscape area provided is 92,676 square feet; 15% is required and 38.2% is proposed. Street trees required is 19 (19 are provided). Street shrubs required is 150 (162 are provided). Parking perimeter trees required is 11 (11 are provided). Parking perimeter shrubs required is 85 (92 are provided). Parking interior total site area is 65,367 square feet; landscape area required is 5,229 square feet (8%) and landscape area provided is 4,077 square feet (6.2%). Trees required is 12 (12 are provided).

Irrigation is required for all provided landscape elements; the irrigation plan provided is showing compliance.

Architectural Plan:

The proposed building height is 27 feet, 6 inches tall; maximum permitted is 35 feet tall. The proposed building has 100% masonry. The length of the building is just over 120 feet wide and meets the City's requirements for a change of direction in an elevation every 60 feet.

House Bill 2439 no longer permits cities to restrict building materials that are permitted by a model code. The building materials proposed comply with the requirements in the 2015 International Building Code.



City of Lucas

City Council Agenda Request

June 10, 2021

Item No. 01

Final plat:

The lot is 5.65 acres of land and provides for right of way as required for the proposed future Allison Lane. The plat provides easements for drainage, including detention, utility easements, and easements for fire lanes. The plat meets the City's requirements for a plat.

Attachments/Supporting Documentation

1. Civil plans, include the landscape plan, site plan, and final plat.
2. Elevations
3. Photometric Plan
4. Location map

Budget/Financial Impact

NA

Recommendation

Staff recommends approving the site plan.

Motion

I make a motion to recommend to the City Council to approve/deny the site plan, landscape plan, elevations, and final plat on behalf of Tractor Supply for use as a commercial farm and garden retail center on a 5.56-acre tract of land located at 495 South Angel Parkway.

No.	DATE	REVISION	BY

EVERGREEN
 DESIGN GROUP
 (800) 680-6630
 15455 Dallas Pkwy., Ste 600
 Addison, TX 75001
 www.EvergreenDesignGroup.com

LANDSCAPE PLANTING

DESIGN:	EMS
DRAWN:	EMS
CHECKED:	RM
DATE:	5/13/2021
SHEET	
LP-1	
File No:	2021-049

PLANT SCHEDULE

TREES	CODE	QTY	BOTANICAL / COMMON NAME	CALIPER	CONTAINER	SIZE
	LOK	6	Quercus virginiana Live Oak	3" Cal.	Cont. or B&B	10'-12'
	QTX	21	Quercus texana Texas Red Oak	3" Cal.	Cont. or B&B	10'-12'
	TD	5	Taxodium distichum Bald Cypress	3" Cal.	Cont. or B&B	10'-12'
	UC	12	Ulmus crassifolia Cedar Elm	3" Cal.	Cont. or B&B	10'-12'
SHRUBS	CODE	QTY	BOTANICAL / COMMON NAME	CONTAINER	SPACING	SIZE
	GA	102	Abelia grandiflora Glossy Abelia	5 gal	Per Plan	24" MIN
	IB	45	Ilex cornuta 'Burfordii Nana' Dwarf Burford Holly	5 gal	Per Plan	18" Min.
	NO	12	Nerium oleander 'Pette Pink' Dwarf Oleander	5 gal	Per Plan	18" Min.
	RC	95	Raphiolepis indica 'Clara' Indian Hawthorn	5 gal	Per Plan	18" Min.
GROUND COVERS	CODE	QTY	BOTANICAL / COMMON NAME	CONT	SPACING	SIZE
	BG	48,589 sf	Cynodon dactylon 'tif 419' Bermuda Grass	Hydromulch		
	CD	30,849 sf	Cynodon dactylon 'tif 419' Bermuda Grass	Sod		

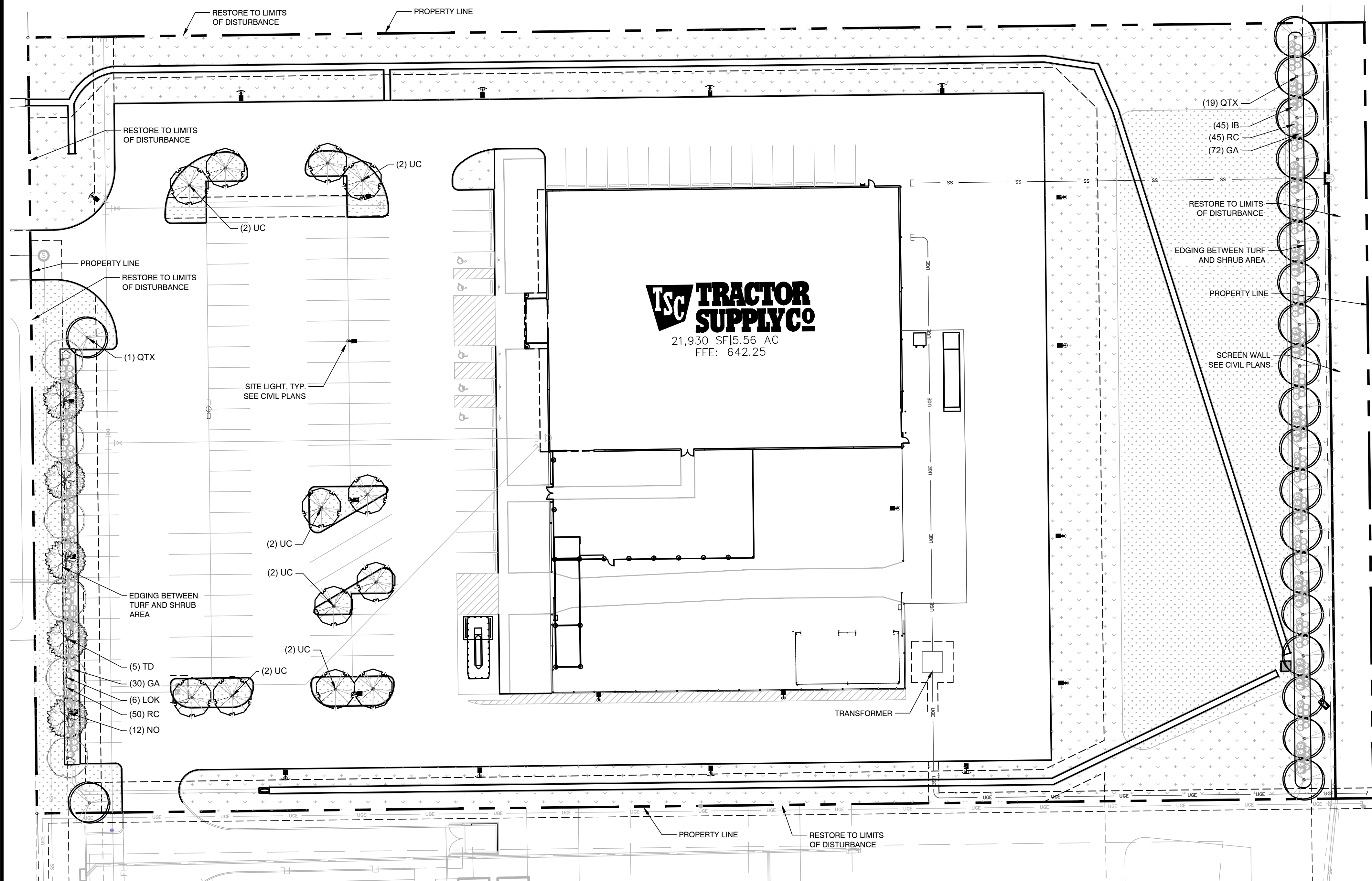

ALLISON LANE
 45' R.O.W.

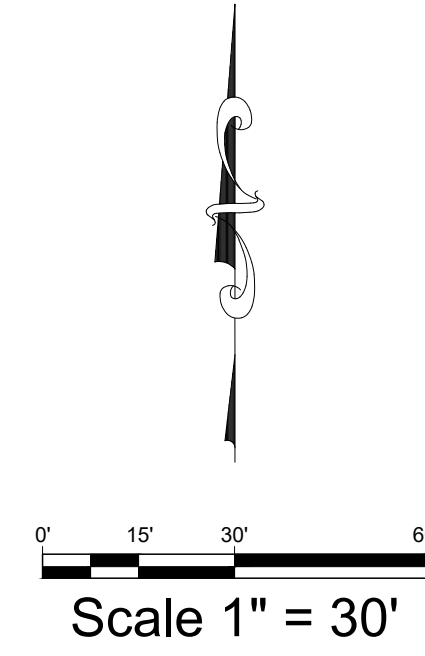

ROOT BARRIERS

THE CONTRACTOR SHALL INSTALL ROOT BARRIERS NEAR ALL NEWLY-PLANTED TREES THAT ARE LOCATED WITHIN FIVE (5) FEET OF PAVING OR CURBS. ROOT BARRIERS SHALL BE "CENTURY" OR "DEEP-ROOT" 24" DEEP PANELS (OR EQUAL). BARRIERS SHALL BE LOCATED IMMEDIATELY ADJACENT TO HARDSCAPE. INSTALL PANELS PER MANUFACTURER'S RECOMMENDATIONS. UNDER NO CIRCUMSTANCES SHALL THE CONTRACTOR USE ROOT BARRIERS OF A TYPE THAT COMPLETELY ENCIRCLE THE ROOTBALL.

MULCHES

AFTER ALL PLANTING IS COMPLETE, CONTRACTOR SHALL INSTALL 3" THICK LAYER OF 1-1/2" SHREDDED WOOD MULCH, NATURAL (UNDYED), OVER LANDSCAPE FABRIC IN ALL PLANTING AREAS (EXCEPT FOR TURF AND SEEDED AREAS). CONTRACTOR SHALL SUBMIT SAMPLES OF ALL MULCHES TO LANDSCAPE ARCHITECT AND OWNER FOR APPROVAL PRIOR TO CONSTRUCTION. ABSOLUTELY NO EXPOSED GROUND SHALL BE LEFT SHOWING ANYWHERE ON THE PROJECT AFTER MULCH HAS BEEN INSTALLED (SUBJECT TO THE CONDITIONS AND REQUIREMENTS OF THE "GENERAL GRADING AND PLANTING NOTES" AND SPECIFICATIONS).

LANDSCAPE CALCULATIONS

TOTAL SITE AREA:	242,217 SF
LANDSCAPE AREA REQUIRED:	36,332 SF (15% OF SITE AREA)
LANDSCAPE AREA PROVIDED:	92,676 SF (38.2% OF SITE AREA)
STREET TREES	
ALLISON LANE FRONTAGE LENGTH:	374.95 LF
STREET TREES REQUIRED:	19 TREES (1 PER 20 LF OF FRONTAGE)
STREET TREES PROVIDED:	19 TREES
SHRUBS REQUIRED:	150 SHRUBS (8 PER 20 LF OF FRONTAGE)
SHRUBS PROVIDED:	162 SHRUBS
PARKING SCREENING	N/A (NOT ADJACENT TO STREET)
PARKING PERIMETER	
TREES REQUIRED:	211 LF
TREES PROVIDED:	11 TREES (1 PER 20 LF OF FRONTAGE)
SHRUBS REQUIRED:	85 SHRUBS (8 PER 20 LF OF FRONTAGE)
SHRUBS PROVIDED:	92 SHRUBS
PARKING INTERIOR	
TOTAL SITE AREA:	65,367 SF
LANDSCAPE AREA REQUIRED:	5,229 SF (8% OF SITE AREA)
LANDSCAPE AREA PROVIDED:	5,280 SF (8% OF SITE AREA)
TREES REQUIRED:	12 TREES (1 TREE /10 SPACES; 119 SPACES)
TREES PROVIDED:	12 TREES
LOADING AREA SCREENING	PROVIDED

GENERAL GRADING AND PLANTING NOTES

- BY SUBMITTING A PROPOSAL FOR THE LANDSCAPE PLANTING SCOPE OF WORK, THE CONTRACTOR CONFIRMS THAT HE HAS READ, AND WILL COMPLY WITH, THE ASSOCIATED NOTES, SPECIFICATIONS, AND DETAILS WITH THIS PROJECT.
- THE GENERAL CONTRACTOR IS RESPONSIBLE FOR REMOVING ALL EXISTING VEGETATION (EXCEPT WHERE NOTED TO REMAIN).
- IN THE CONTEXT OF THESE PLANS, NOTES, AND SPECIFICATIONS, "FINISH GRADE" REFERS TO THE FINAL ELEVATION OF THE SOIL SURFACE (NOT TOP OF MULCH) AS INDICATED ON THE GRADING PLANS.
 - BEFORE STARTING WORK, THE LANDSCAPE CONTRACTOR SHALL VERIFY THAT THE ROUGH GRADES OF ALL LANDSCAPE AREAS ARE WITHIN +0.1% OF FINISH GRADE. SEE SPECIFICATIONS FOR MORE DETAILED INSTRUCTION ON TURF AREA AND PLANTING BED PREPARATION.
 - CONSTRUCT AND MAINTAIN FINISH GRADES AS SHOWN ON GRADING PLANS, AND CONSTRUCT AND MAINTAIN SLOPES AS RECOMMENDED BY THE GEOTECHNICAL REPORT. ALL LANDSCAPE AREAS SHALL HAVE POSITIVE DRAINAGE AWAY FROM STRUCTURES AT THE MINIMUM SLOPE SPECIFIED IN THE REPORT AND ON THE GRADING PLANS, AND AREAS OF POTENTIAL PONDING SHALL BE REGRADED TO BLEND IN WITH THE SURROUNDING GRADES AND ELIMINATE PONDING POTENTIAL.
 - THE LANDSCAPE CONTRACTOR SHALL DETERMINE WHETHER OR NOT THE EXPORT OF ANY SOIL WILL BE NEEDED, TAKING INTO ACCOUNT THE ROUGH GRADE PROVIDED, THE AMOUNT OF SOIL AMENDMENTS TO BE ADDED (BASED ON A SOIL TEST, PER SPECIFICATIONS), AND THE FINISH GRADES TO BE ESTABLISHED.
 - ENSURE THAT THE FINISH GRADE IN SHRUB AREAS IMMEDIATELY ADJACENT TO WALKS AND OTHER WALKING SURFACES, AFTER INSTALLING SOIL AMENDMENTS, IS 3" BELOW THE ADJACENT FINISH GRADE, IN ORDER TO ALLOW FOR PROPER MULCH DEPTH. TAPER THE SOIL SURFACE TO MEET FINISH GRADE, AS SPECIFIED ON THE GRADING PLANS, AT APPROXIMATELY 18" AWAY FROM THE WALKS.
 - ENSURE THAT THE FINISH GRADE IN TURF AREAS IMMEDIATELY ADJACENT TO WALKS AND OTHER WALKING SURFACES, AFTER INSTALLING SOIL AMENDMENTS, IS 1" BELOW THE FINISH GRADE OF THE WALKS, AT APPROXIMATELY 18" AWAY FROM THE WALKS.
 - SHOULD ANY CONFLICTS AND/OR DISCREPANCIES ARISE BETWEEN THE GRADING PLANS, GEOTECHNICAL REPORT, THESE NOTES AND PLANS, AND ACTUAL CONDITIONS, THE CONTRACTOR SHALL IMMEDIATELY BRING SUCH ITEMS TO THE ATTENTION OF THE LANDSCAPE ARCHITECT, GENERAL CONTRACTOR, AND OWNER.
- ALL PLANT LOCATIONS ARE DIAGRAMMATIC. ACTUAL LOCATIONS SHALL BE VERIFIED WITH THE LANDSCAPE ARCHITECT OR DESIGNER PRIOR TO PLANTING. THE LANDSCAPE CONTRACTOR SHALL ENSURE THAT ALL REQUIREMENTS OF THE PERMITTING AUTHORITY ARE MET (I.E., MINIMUM PLANT QUANTITIES, PLANTING METHODS, TREE PROTECTION METHODS, ETC.).
 - THE LANDSCAPE CONTRACTOR IS RESPONSIBLE FOR DETERMINING PLANT QUANTITIES; PLANT QUANTITIES SHOWN ON LEGENDS AND CALLOUTS ARE FOR GENERAL INFORMATION ONLY. IN THE EVENT OF A DISCREPANCY BETWEEN THE PLAN AND THE PLANT LEGEND, THE PLANT QUANTITY AS SHOWN ON THE PLAN (FOR INDIVIDUAL SYMBOLS) OR CALLOUT (FOR GROUNDCOVER PATTERNS) SHALL TAKE PRECEDENCE.
 - NO SUBSTITUTIONS OF PLANT MATERIALS SHALL BE ALLOWED WITHOUT THE WRITTEN PERMISSION OF THE LANDSCAPE ARCHITECT. IF SOME OF THE PLANTS ARE NOT AVAILABLE, THE LANDSCAPE CONTRACTOR SHALL NOTIFY THE LANDSCAPE ARCHITECT IN WRITING (VIA PROPER CHANNELS).
 - THE CONTRACTOR SHALL, AT A MINIMUM, PROVIDE REPRESENTATIVE PHOTOS OF ALL PLANTS PROPOSED FOR THE PROJECT. THE CONTRACTOR SHALL ALLOW THE LANDSCAPE ARCHITECT AND THE OWNER'S OWNER'S REPRESENTATIVE TO INSPECT, AND APPROVE OR REJECT, ALL PLANTS DELIVERED TO THE JOBSITE. REFER TO SPECIFICATIONS FOR ADDITIONAL REQUIREMENTS FOR SUBMITTALS.
- THE CONTRACTOR SHALL MAINTAIN THE LANDSCAPE IN A HEALTHY CONDITION FOR 90 DAYS AFTER ACCEPTANCE BY THE OWNER. REFER TO SPECIFICATIONS FOR CONDITIONS OF ACCEPTANCE FOR THE START OF THE MAINTENANCE PERIOD, AND FOR FINAL ACCEPTANCE AT THE END OF THE MAINTENANCE PERIOD.
- SEE SPECIFICATIONS AND DETAILS FOR FURTHER REQUIREMENTS.

VICINITY MAP NOT TO SCALE



PLOTTED BY: E5430
 PLOT DATE: 5/13/2021 9:05 AM
 LOCATION: C:\USERS\LEH\30\DRG\BOX (EDG)\EDG - SHARED\2021\TRACTOR SUPPLY - LUCAS TX\TSC LUCAS 2021-05-13 LP.DWG
 LAST SAVED: 5/13/2021 8:42 AM



PLANTING SPECIFICATIONS

GENERAL
A. QUALIFICATIONS OF LANDSCAPE CONTRACTOR
1. ALL LANDSCAPE WORK SHOWN ON THESE PLANS SHALL BE PERFORMED BY A SINGLE FIRM SPECIALIZING IN LANDSCAPE PLANTING.

B. SUBMITTALS
1. THE CONTRACTOR SHALL PROVIDE SUBMITTALS AND SAMPLES, IF REQUIRED, TO THE LANDSCAPE ARCHITECT AND RECEIVE APPROVAL IN WRITING FOR SUCH SUBMITTALS BEFORE WORK COMMENCES.

PRODUCTS
A. ALL MANUFACTURED PRODUCTS SHALL BE NEW
B. CONTAINER AND BALLED-AND-BURLAPPED PLANTS:
1. FURNISH NURSERY-GROWN PLANTS COMPLYING WITH ANSI Z601-2014. PROVIDE WELL-SHAPED, FULLY BRANCHED, HEALTHY, VIGOROUS STOCK FREE OF DISEASE, INSECTS, EGGS, LARVAE, AND DEFECTS SUCH AS KNOTS, SUN SCALD, INJURIES, ABRASIONS, AND DISFIGUREMENT.

C. GENERAL PLANTING
1. REMOVE ALL NURSERY TAGS AND STAKES FROM PLANTS. EXCEPT IN AREAS TO BE PLANTED WITH ORNAMENTAL GRASSES, APPLY PRE-EMERGENT HERBICIDES AT THE MANUFACTURER'S RECOMMENDED RATE.

METHODS
A. SOIL PREPARATION
1. BEFORE STARTING WORK, THE LANDSCAPE CONTRACTOR SHALL VERIFY THAT THE GRADE OF ALL LANDSCAPE AREAS ARE WITHIN +/-0.1' OF FINISH GRADE.

K. WARRANTY PERIOD, PLANT GUARANTEE AND REPLACEMENTS
1. THE LANDSCAPE CONTRACTOR SHALL GUARANTEE ALL TREES, SHRUBS, PERENNIALS, SOD, AND IRRIGATION SYSTEMS FOR A PERIOD OF ONE YEAR FROM THE DATE OF THE OWNER'S FINAL ACCEPTANCE (90 DAYS FOR ANNUAL PLANTS).

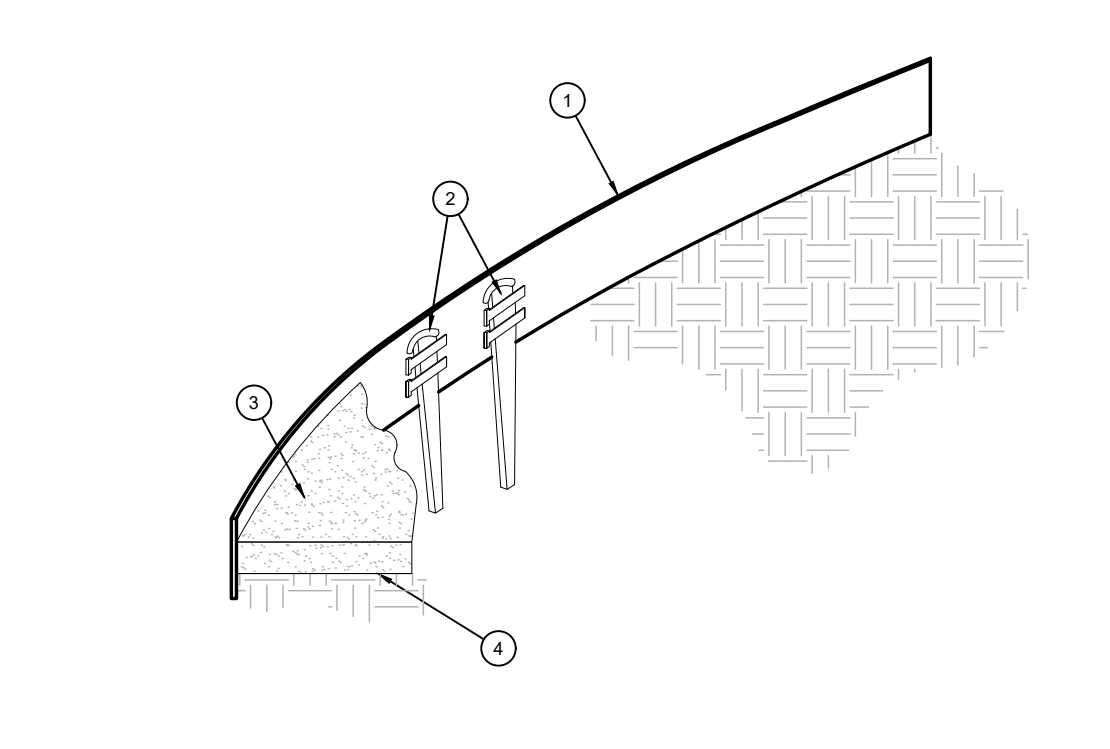

- 1 ROLLED-TOP STEEL EDGING PER PLANS.
2 TAPERED STEEL STAKES.
3 MULCH, TYPE AND DEPTH PER PLANS.
4 FINISH GRADE.

D STEEL EDGING
SCALE: NOT TO SCALE

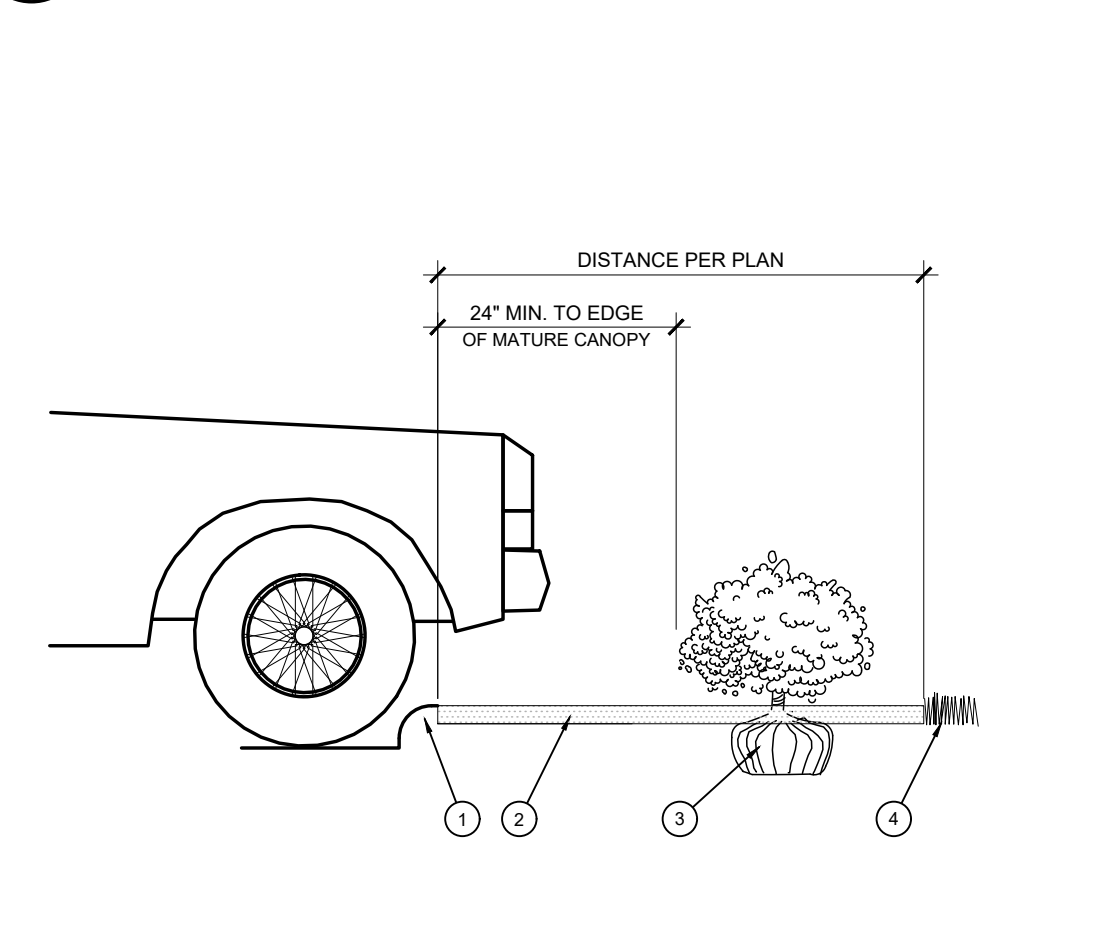

- 1 CURB.
2 MULCH LAYER.
3 PLANT.
4 TURF (WHERE SHOWN ON PLAN).

E PLANTING AT PARKING AREA
SCALE: NOT TO SCALE

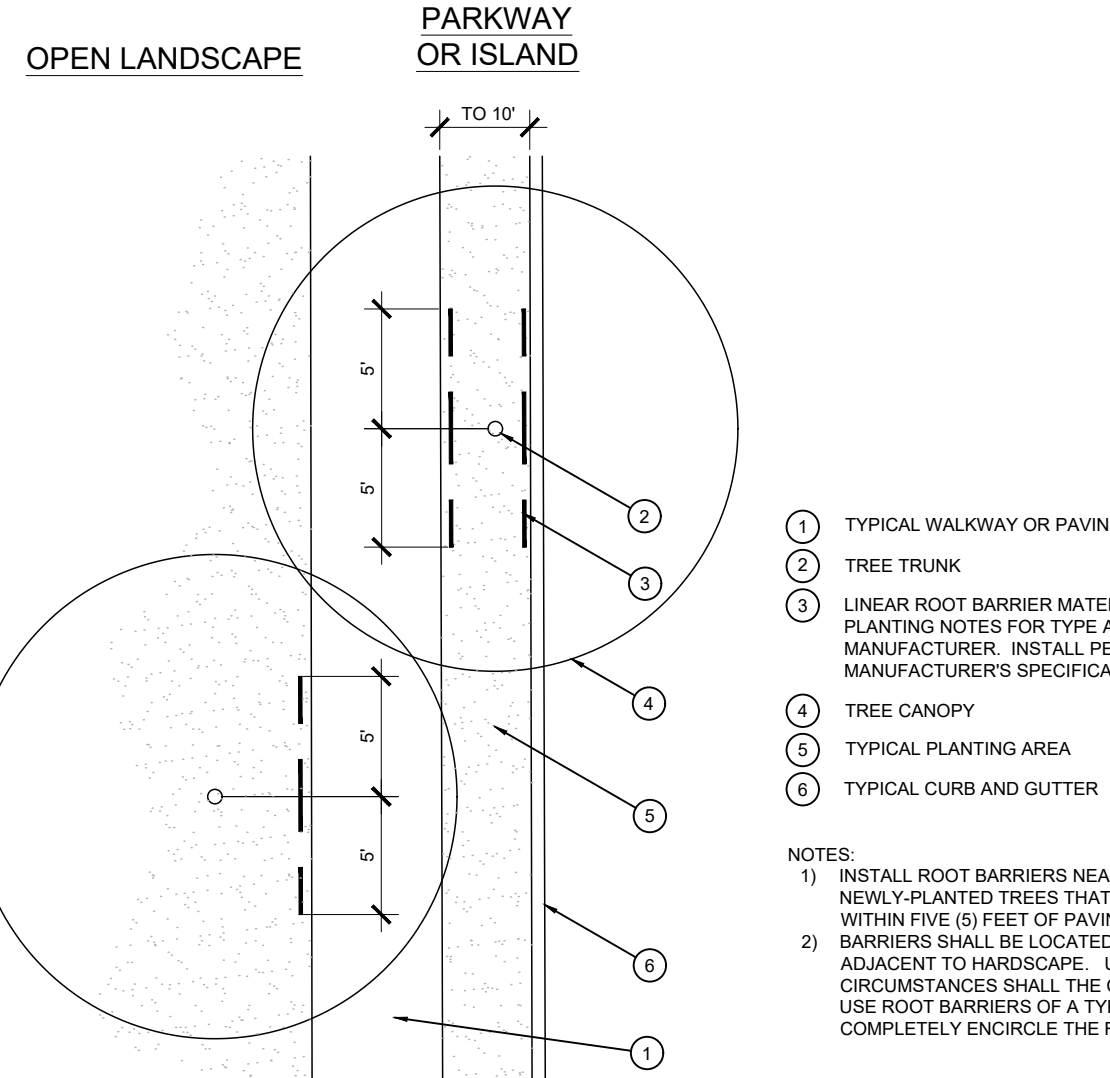

F ROOT BARRIER - PLAN VIEW
SCALE: NOT TO SCALE

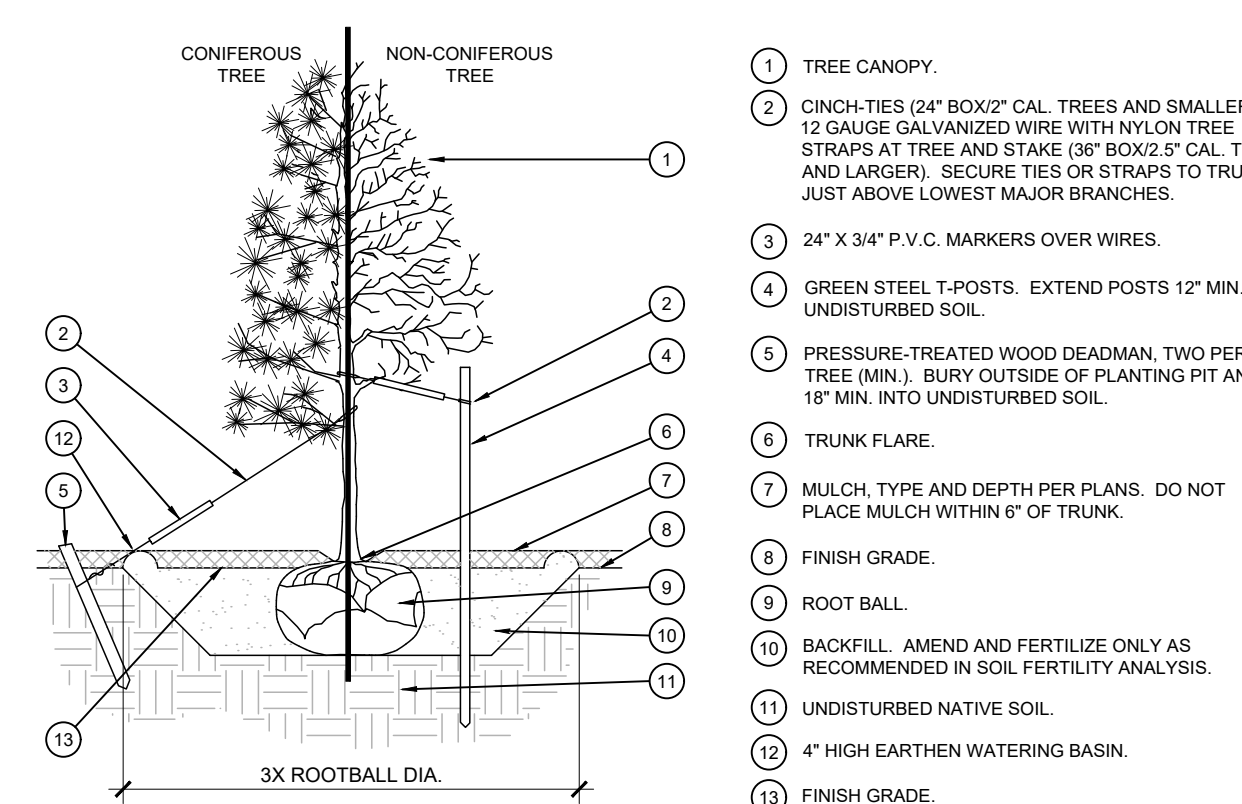

- 1 TREE CANOPY.
2 CINCH-TIES (24" BOXZ" CAL. TREES AND SMALLER) OR 12 GAUGE GALVANIZED WIRE WITH 1/2" GAL. ON TREE STRAPS AT TREE AND STAKE (38" BOXZ" CAL. TREES AND LARGER). SECURE TIES OR STRAPS TO TRUNK JUST ABOVE LOWEST MAJOR BRANCHES.
3 24" X 3/4" P.V.C. MARKERS OVER WIRES.

A TREE PLANTING
SCALE: NOT TO SCALE

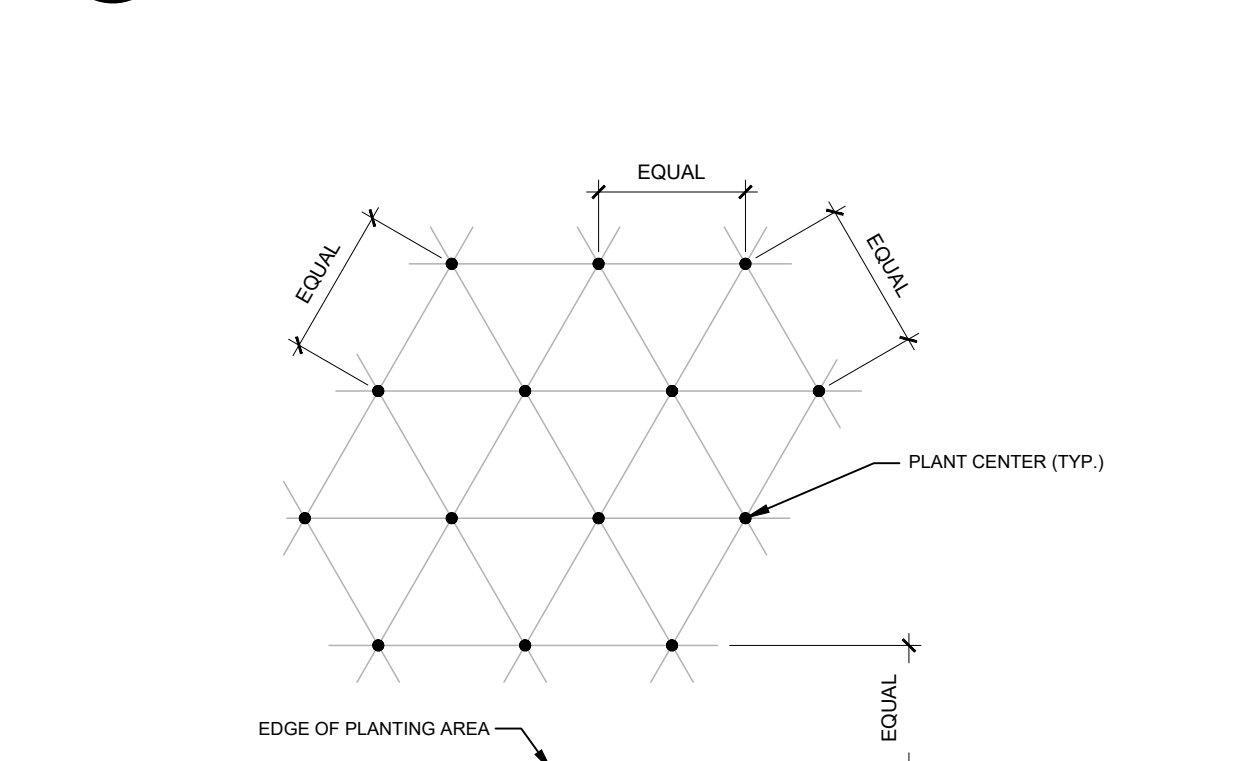
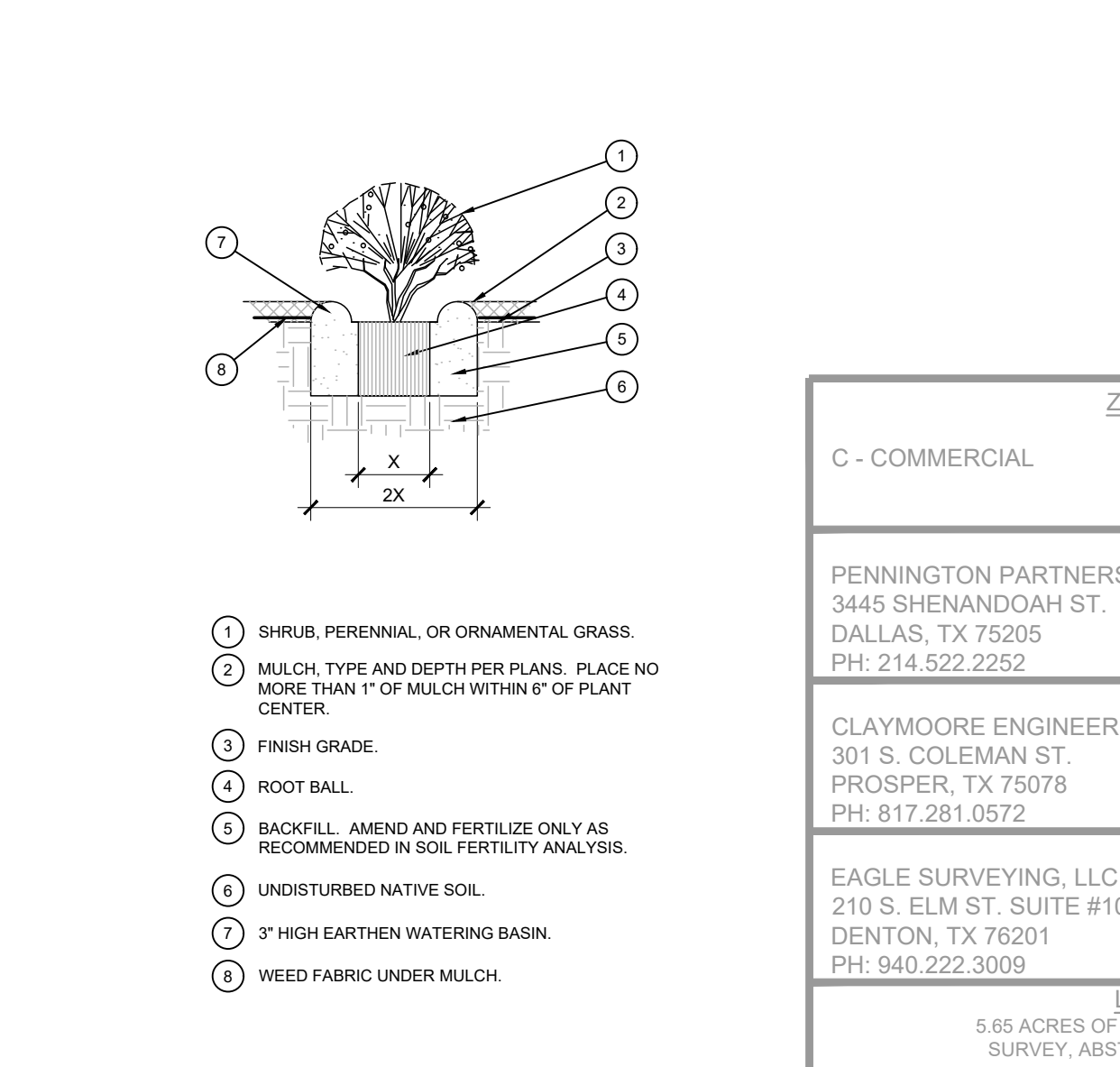

Table with columns: PLANT SPACING, AREA DIVIDER, PLANT SPACING, AREA DIVIDER. Includes notes on plant spacing calculations.

C PLANT SPACING
SCALE: NTS



B SHRUB AND PERENNIAL PLANTING
SCALE: NTS

EVERGREEN DESIGN GROUP logo and contact information including address in Dallas, TX and phone number (800) 680-6630.

LANDSCAPE ARCHITECT logo for ERIC M. SHERIDAN, STATE OF TEXAS, license number 1180, dated 05-13-2021.

TRACTOR SUPPLY CO. logo and address: LOT 1, BLOCK A, LUCAS, TX.

ZONING DESCRIPTION table with columns for No., DATE, REVISION, and BY.

OWNER and APPLICANT information for PENNINGTON PARTNERS, LLC and CLAYMOORE ENGINEERING, INC.

LEGAL DESCRIPTION and SURVEYOR information for 5.65 ACRES OF LAND SITUATED IN THE WILLIAM SNIDER SURVEY.

DESIGN, DRAWING, CHECKED, DATE, SHEET, COUNTY, SURVEY, ABSTRACT NO., and File No. information.

PLOTTED BY: CURTIS PETERS
 PLOT DATE: 5/4/2021 11:13 AM
 LOCATION: Z:\PROJECTS\2021-049 LUCAS TSC\CADD\SHEETS\SP-1 SITE PLANDWG
 LAST SAVED: 5/4/2021 11:11 AM

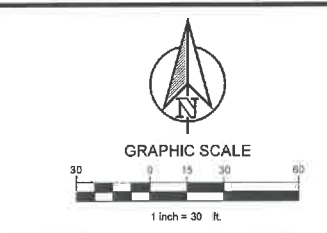
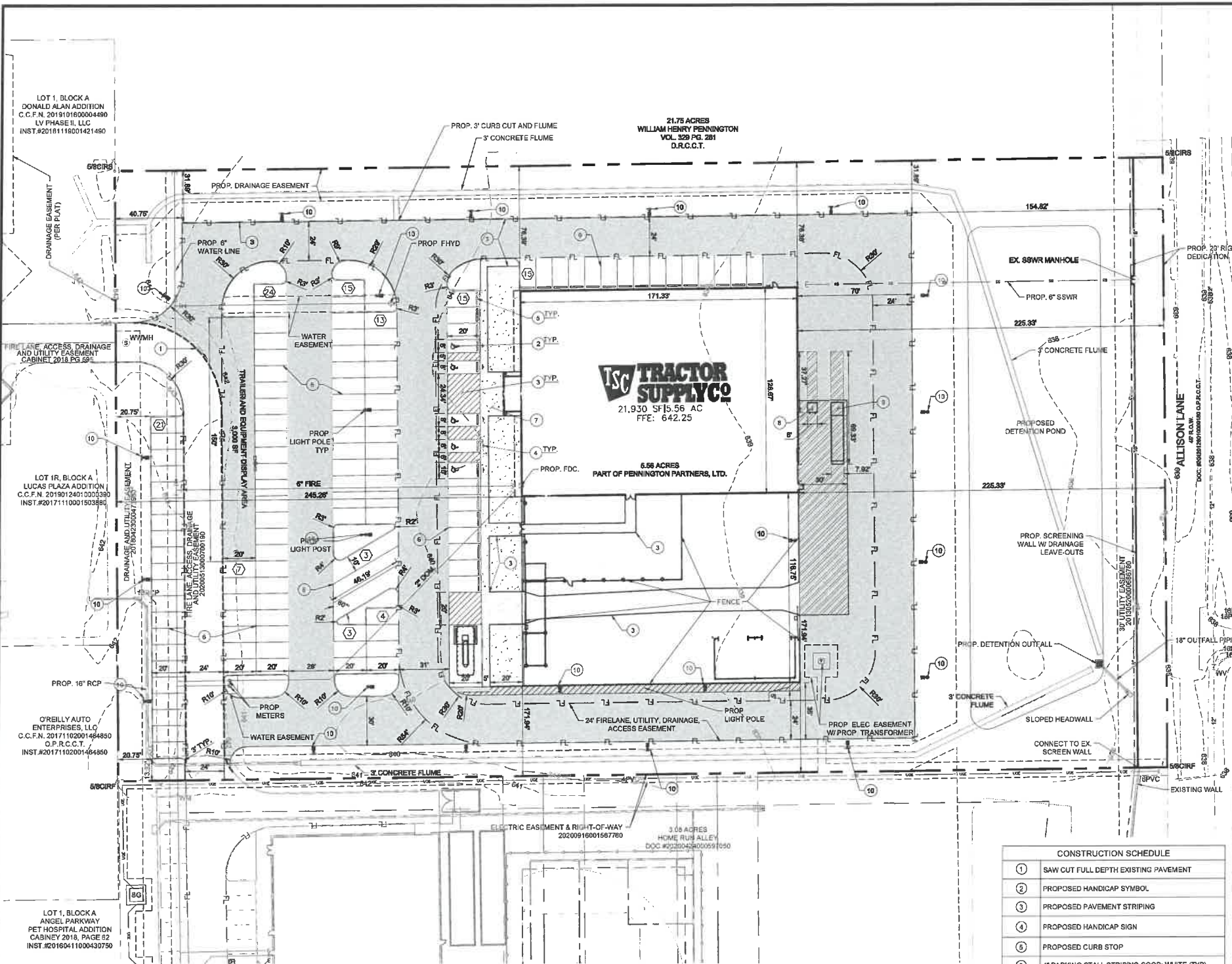

LEGEND

[Symbol]	STANDARD DUTY CONCRETE PAVEMENT
[Symbol]	HEAVY DUTY CONCRETE PAVEMENT
[Symbol]	DUMPSTER AREA CONCRETE PAVEMENT
[Symbol]	SIDEWALK CONCRETE PAVEMENT
[Symbol]	PROPOSED CONCRETE CURB AND GUTTER
[Symbol]	PARKING COUNT
[Symbol]	FULL-DEPTH SAWCUT
[Symbol]	PROPOSED FIRE LANE STRIPPING

NOTES:

1. ALL DIMENSIONS ARE TO FACE OF CURB UNLESS OTHERWISE NOTED.
2. REFER TO ARCHITECTURAL PLANS FOR BUILDING DIMENSIONS AND EXACT DOOR LOCATIONS.
3. REFER TO ARCHITECTURAL PLANS FOR FENCE AND GATE DETAILS.

SITE DATA SUMMARY

LOT	ZONING	PROPOSED USE	LOT SIZE (ACRES)	LOT SIZE (SQ. FT.)	BLDG. AREA (SQ. FT.)	BLDG. HGT. (FT)	# OF STORES	LOT COVERAGE		FLR AREA RATIO		PARKING		HANDICAP SP.		TOTAL IMPERVIOUS		TOTAL PERVIOUS		
								REQ.	PROV.	REQ.	PROV.	REQ. RATIO	PROV.	REQ.	PROV.	REQ.	PROV.	REQ.	PROV.	REQ.
PROPOSED LOT 1	C-COMMERCIAL	RETAIL	5.56	242,218	21,930	25'-0" MAX.	1	48% MAX	9.1%	500 SF MIN.	0.09	RETAIL (1 PER 200 SF)	110	120	5	5	148,827	61%	93,391	39%

CONSTRUCTION SCHEDULE

1	SAW CUT FULL DEPTH EXISTING PAVEMENT
2	PROPOSED HANDICAP SYMBOL
3	PROPOSED PAVEMENT STRIPING
4	PROPOSED HANDICAP SIGN
5	PROPOSED CURB STOP
6	4" PARKING STALL STRIPING COOR: WHITE (TYP)
7	PROPOSED CONCRETE SIDEWALK
8	DUMPSTER WITH ENCLOSURE (REFER TO ARCHITECTURAL PLANS FOR DETAILS)
9	TRUCK DOCK/RAMP (REFER TO ARCHITECTURAL PLANS FOR DETAILS)

ZONING DESCRIPTION:
C - COMMERCIAL

OWNER:
PENNINGTON PARTNERS, LLC
3445 SHENANDOAH ST.
DALLAS, TX 75205
PH: 214.522.2212
CONTACT NAME: BILL SHIPLEY

APPLICANT:
CLAYMOORE ENGINEERING, INC.
301 S. COLEMAN ST.
PROSPER, TX 76078
PH: 817.281.0572
CONTACT NAME: MATT MOORE

SURVEYOR:
EAGLE SURVEYING, LLC
210 S. ELM ST. SUITE #104
DENTON, TX 76201
PH: 840.222.3009
CONTACT NAME: TYLER RANK

LEGAL DESCRIPTION:
6.58 ACRES OF LAND SITUATED IN THE WILLIAM SNIDER SURVEY, ABSTRACT NO. 821, CITY OF LUCAS, COLLIN COUNTY, TEXAS.

CITY: LUCAS **STATE:** TEXAS

COUNTY: COLLIN **SUBDIV:** WILLIAM SNIDER **ABSTRACT NO.:** 821

CLAYMOORE ENGINEERING

PRELIMINARY
FOR REVIEW ONLY
NOT FOR CONSTRUCTION PURPOSES.
CLAYMOORE ENGINEERING
PROSPER, TX 76078
OFFICE: 817.281.0572
P.O. # 125635, DALLAS, TX 75201

TRACTOR SUPPLY CO.
LOT 1, BLOCK A TRACTOR SUPPLY ADDITION
LUCAS, TX

SITE PLAN

BY: _____
DATE: _____

DESIGN: CWP
DRAWN: SD
CHECKED: ASD
DATE: 5/4/2021

SHEET
SP-1

File No: 221-815

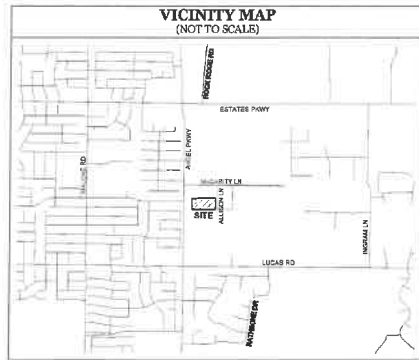

- GENERAL NOTES**
- The purpose of this plat is to create an official lot of record from a tract of land.
 - This property is located in "Non-shaded Zone X" according to the F.E.M.A. Flood Insurance Rate Map dated June 2, 2009 as shown on Map Number 48085C04651.
 - The bearings and grid coordinates shown on this plat are based on GPS observations utilizing the AllTerra RTK Network, North American Datum of 1983 (Adjustment Realization 2011).
 - Selling a portion of this addition by metes and bounds is a violation of City Ordinance and State Law, and is subject to fines and/or withholding of utilities and building permits.

LOT SUMMARY TABLE	
GROSS	5.65 AC. 245,902 S.F.
R.O.W.	0.00 AC. 0 S.F.
NET	5.65 AC. 245,902 S.F.

- LEGEND**
- POB = POINT OF BEGINNING
 - POC = POINT OF COMMENCING
 - CIRS = CAPPED IRON ROD SET
 - CIRF = CAPPED IRON ROD FOUND
 - DOC. NO. = DOCUMENT NUMBER
 - PLAT RECORDS = PLAT RECORDS, COLLIN COUNTY, TEXAS
 - O.P.R.C.C.T. = OFFICIAL PUBLIC RECORDS, COLLIN COUNTY, TEXAS
 - F.L.A.D.U.E. = FIRE LANE ACCESS, DRAINAGE & UTILITY EASEMENT

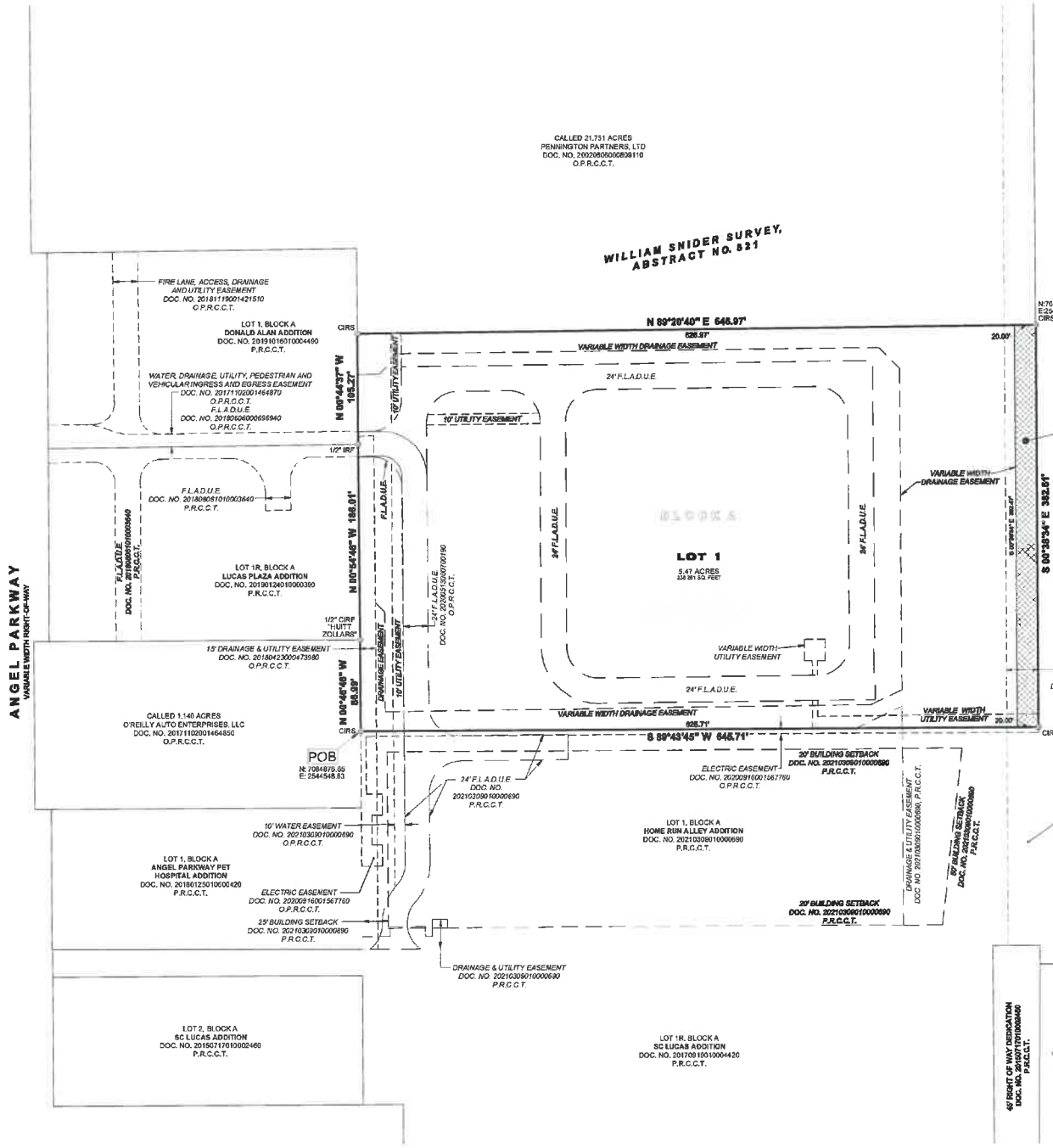

- LOT 1 FOX GLEN ADDITION DOC. NO. 2012012601000160 P.R.C.C.T.
- LOT 2 FOX GLEN ADDITION DOC. NO. 2012012601000160 P.R.C.C.T.
- LOT 3 FOX GLEN ADDITION DOC. NO. 2012012601000160 P.R.C.C.T.
- LOT 4 FOX GLEN ADDITION DOC. NO. 2012012601000160 P.R.C.C.T.
- LOT 5 FOX GLEN ADDITION DOC. NO. 2012012601000160 P.R.C.C.T.
- LOT 1, BLOCK A DONALD ALAN ADDITION DOC. NO. 2019101601000449 P.R.C.C.T.
- LOT 1R, BLOCK A LUCAS PLAZA ADDITION DOC. NO. 2019012401000389 P.R.C.C.T.
- LOT 1, BLOCK A ANGEL PARKWAY FET HOSPITAL ADDITION DOC. NO. 2016012301000420 P.R.C.C.T.
- LOT 1R, BLOCK A SC LUCAS ADDITION DOC. NO. 2016012301000449 P.R.C.C.T.
- LOT 1R, BLOCK A SC LUCAS ADDITION DOC. NO. 2017091001000442 P.R.C.C.T.

OWNER'S CERTIFICATE & DEDICATION

STATE OF TEXAS §
COUNTY OF COLLIN §

WHEREAS, PENNINGTON PARTNERS, LLC, is the owner of a 5.65 acre tract out of the William Snider Survey, Abstract Number 821, situated in the City of Lucas, Collin County, Texas, being a part of a called 21.751 acre tract conveyed by Warranty Deed with Vendor's Lien of record in Document Number D202020606000809110 of the Official Public Records of Collin County, Texas, and being more particularly described by metes and bounds as follows:

BEGINNING, at a CIRS in the East line of a called 1.140 acre tract of land conveyed to O'Reilly Auto Enterprises, LLC by deed of record in Document Number 2017110201464850 of said Official Public Records, being the Northeast corner of Lot 1, Block A of Home Run Alley Addition, a subdivision of record in Document Number 2019010601000389 of the Plat Records of Collin County, Texas, and also being the Southwest corner hereof;

THENCE, N00°46'45"W, along the East line of said 1.140 acre tract, a distance of 88.99 feet to a 1/2" iron rod with plastic cap stamped "HUITT ZOLLARS" found at the Northeast corner of Lot 1R, Block A of Lucas Plaza Addition, a subdivision of record in Document Number 2019012401000389 of said Plat Records;

THENCE, N00°54'48"W, along the East line of said Lot 1R, Block A of Lucas Plaza Addition, a distance of 186.01 feet to a 1/2" iron rod found at the Northeast corner of said Lot 1R, also being the Southeast corner of Lot 1, Block A of Donald Alan Addition, a subdivision of record in Document Number 2019010601000389 of said Plat Records;

THENCE, N00°44'37"W, along the East line of said Lot 1, Block A of Donald Alan Addition, a distance of 105.27 feet to a CIRS at the Northwest corner hereof;

THENCE, N89°20'40"E, over and across said 21.751 acre tract along the North line hereof, a distance of 646.97 feet to a CIRS in the West Right-of-Way line of Allison Lane, being the East line of said 21.751 acre tract, and also being the Northeast corner hereof;

THENCE, S00°38'34"E, along the West Right-of-Way line of Allison Lane, also being the East line of said 21.751 acre tract a distance of 392.61 feet to a CIRS, being the Southeast corner hereof;

THENCE, S89°43'45"W, along the North line of said Home Run Alley Addition, a distance of 645.71 feet to the POINT OF BEGINNING and containing an area of 5.65 Acres, or (245,902 Square Feet) of land, more or less.

NOW THEREFORE KNOW ALL MEN BY THESE PRESENTS:

THAT, PENNINGTON PARTNERS, LLC, does hereby adopt this plat, designating herein described property as TRACTOR SUPPLY ADDITION, an addition to the City of Lucas, Collin County, Texas, and does hereby dedicate to public use forever all streets, alleys, paths, walkways, drains, easements and public places thereon shown for the purpose and consideration therein expressed. No buildings, fences, trees, shrubs or other improvements or growths shall be constructed or placed upon, over or across the drainage and utility easements as shown. Said drainage and utility easements being hereby reserved for the mutual use and accommodation of all public utilities desiring to use same. All and any public utility shall have the right to remove and keep removed all or parts of any buildings, fences, trees, shrubs or other improvements or growths which may in any way encroach or interfere with the construction, maintenance, or efficiency of its respective system of the drainage and utility easement and all public utilities shall at all times have the full right of ingress and egress to or from and upon the said drainage and utility easements for the purpose of constructing, reconstructing, inspecting, patrolling, maintaining and adding to or removing all or parts of its respective systems without the necessity at any time of procuring the permission of anyone.

OWNER: PENNINGTON PARTNERS, LLC

BY: _____ Date _____

STATE OF TEXAS §
COUNTY OF _____ §

BEFORE ME, the undersigned authority, on this day personally appeared _____, known to me to be the person whose name is subscribed to the foregoing instrument, and acknowledged to me that he executed the same for the purposes and considerations therein expressed and in the capacity therein stated.

GIVEN UNDER MY HAND AND SEAL OF THE OFFICE this _____ day of _____, 2021.

Notary Public in and for the State of Texas

CERTIFICATE OF SURVEYOR

STATE OF TEXAS §
COUNTY OF DENTON §

I, MATTHEW RAABE, Registered Professional Land Surveyor, do hereby certify that this plat was prepared from an actual survey made on the ground and that the monuments shown hereon were found or placed with 1/2-inch iron rods with green plastic caps stamped "EAGLE SURVEYING" under my direction and supervision in accordance with the current provisions of the Texas Administrative Code and the Ordinances of the City of Lucas, Collin County, Texas.

PRELIMINARY
This document shall not be recorded for any purpose and shall not be used or relied upon as a final survey document.

Matthew Raabe, R.P.L.S. # 6402 _____ Date _____

STATE OF TEXAS §
COUNTY OF DENTON §

BEFORE ME, the undersigned authority, on this day personally appeared MATTHEW RAABE, known to me to be the person whose name is subscribed to the foregoing instrument, and acknowledged to me that he executed the same for the purposes and considerations therein expressed and in the capacity therein stated.

GIVEN UNDER MY HAND AND SEAL OF THE OFFICE this _____ day of _____, 2021.

Notary Public in and for the State of Texas

P&Z CERTIFICATE OF APPROVAL

APPROVED by the City of Lucas Planning and Zoning Commission on this _____ day of _____, 2021.

Planning and Zoning Chairman _____

ATTEST: _____

City Secretary _____

CERTIFICATE OF APPROVAL

The Director of Public Works of the City of Lucas, Texas hereby certifies that to the best of his/her knowledge or belief, this subdivision plat conforms to all requirements of the Code of Ordinance and with engineering construction standards and processes adopted by the City of Lucas, Texas as to which his/her approval is required.

Director of Public Works _____ Date _____

The Director of Planning and Community Development of the City of Lucas, Texas hereby certifies that to the best of his/her knowledge or belief, this subdivision plat conforms to all requirements of the Code of Ordinance, or as may have been amended or modified, as allowed, by the Planning and Zoning Commission as to which his/her approval is required.

Director of Planning & Community Development _____ Date _____

FINAL PLAT
TRACTOR SUPPLY
ADDITION
LOT 1, BLOCK A

BEING 5.65 ACRES OF LAND SITUATED IN THE WILLIAM SNIDER SURVEY, ABSTRACT No. 821, CITY OF LUCAS, COLLIN COUNTY, TEXAS ZONING: C (COMMERCIAL)

Project: 2104.028
Date: 04/12/2021
Drafter: CHM/TAR

EAGLE SURVEYING, LLC
210 S. Elm Street, Suite: 104
Denton, TX 76201
(940) 222-3009
TX Firm #10194177

SURVEYOR
Eagle Surveying, LLC
Contact: Tyler Rank
210 S. Elm Street, Suite: 104
Denton, TX 76201
(940) 222-3009

ENGINEER
Claymore Engineering, Inc.
Contact: Matt Moore
301 S. Coleman, Suite: 40
Prosper, TX 75078
(817) 281-0572

OWNER
Pennington Partners, LLC
3445 Shenandoah St.
Dallas, TX 75225-2219

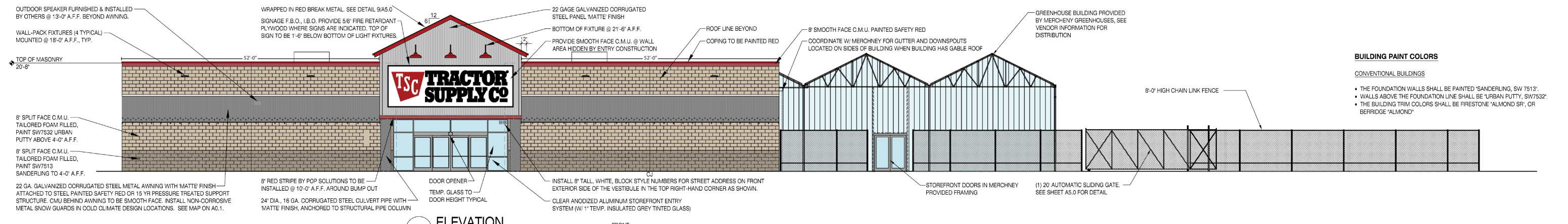

1 ELEVATION FRONT

- BUILDING PAINT COLORS**
- CONVENTIONAL BUILDINGS
- THE FOUNDATION WALLS SHALL BE PAINTED 'SANDERLING, SW 7513'
 - WALLS ABOVE THE FOUNDATION LINE SHALL BE 'URBAN PUTTY, SW7532'
 - THE BUILDING TRIM COLORS SHALL BE FIRESTONE 'ALMOND SR', OR BERRIDGE 'ALMOND'

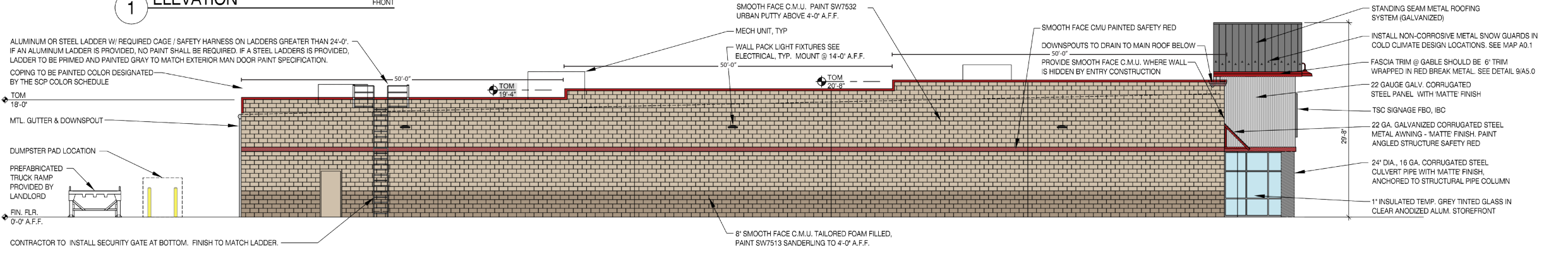

2 ELEVATION LEFT SIDE

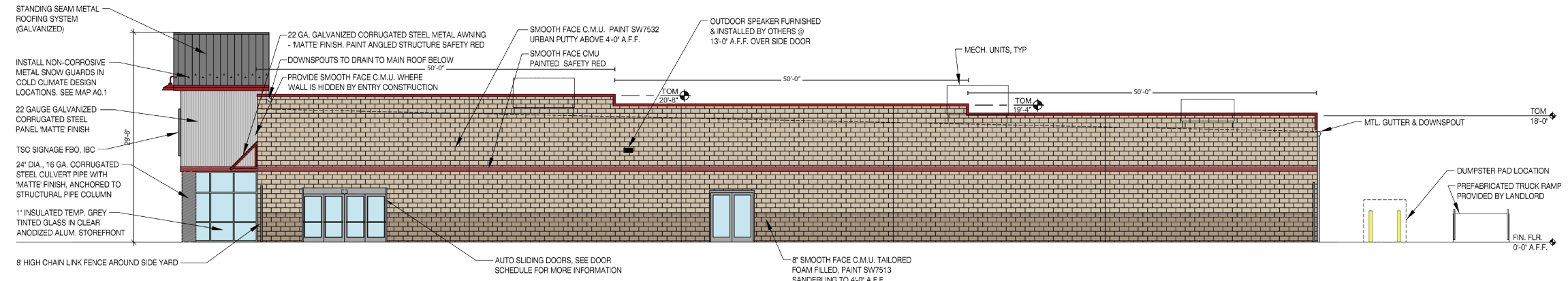

3 ELEVATION RIGHT SIDE

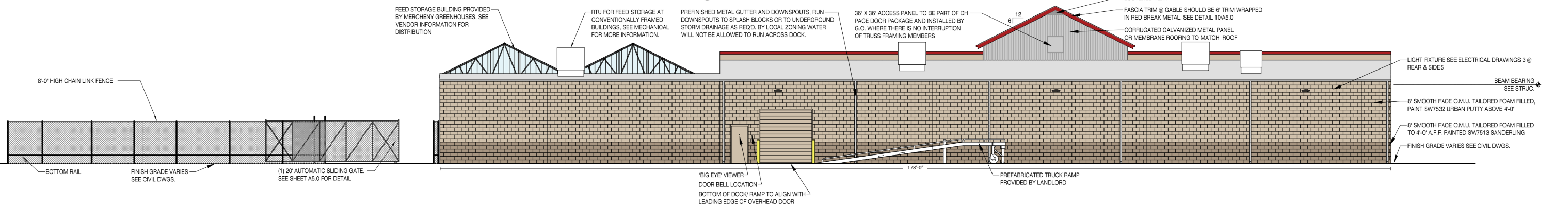

4B ELEVATION REAR

TRACTOR SUPPLY CO

THIS DOCUMENT IS
PRELIMINARY
 IN NATURE AND IS NOT
 A FINAL, SIGNED AND
 SEALED DOCUMENT

CYNERGY ENGINEERING, PLLC
 REGISTRATION # F-2220
 MATTHEW RUTKOWSKI
 ENGINEER OF RECORD

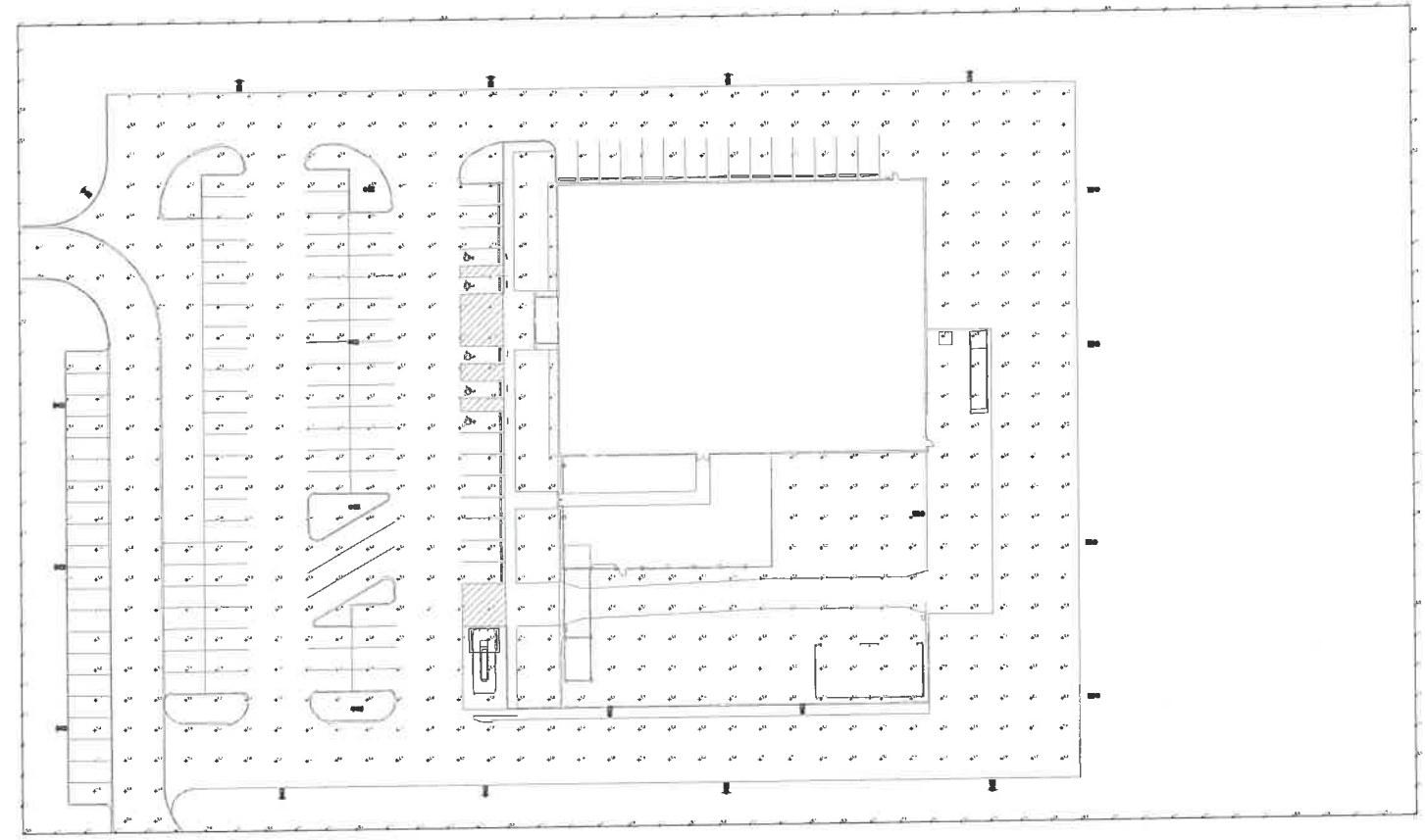

1 SITE PHOTOMETRIC PLAN 
 SCALE: 1/32"=1'-0"

STATISTICS				
DESCRIPTION	SYMBOL	AVG	MAX	MIN
PROPERTY LINE	+	0.2	0.7	0.0
PARKING LOT	+	1.4	2.9	0.4



STIPULATION FOR REUSE

ISSUE / REVISION

ISSUE DATE:
 CHECKED BY: MJR
 DRAWN BY: JRM

SHEETNAME:
 ELECTRICAL PHOTOMETRIC PLAN

Project: 140275 - 10A - 11 - 14
 11/15/2014 10:00:00 AM
 C:\Users\jrm\Documents\140275\10A\11\14\11-14-14.dwg

Location map Tractor Supply

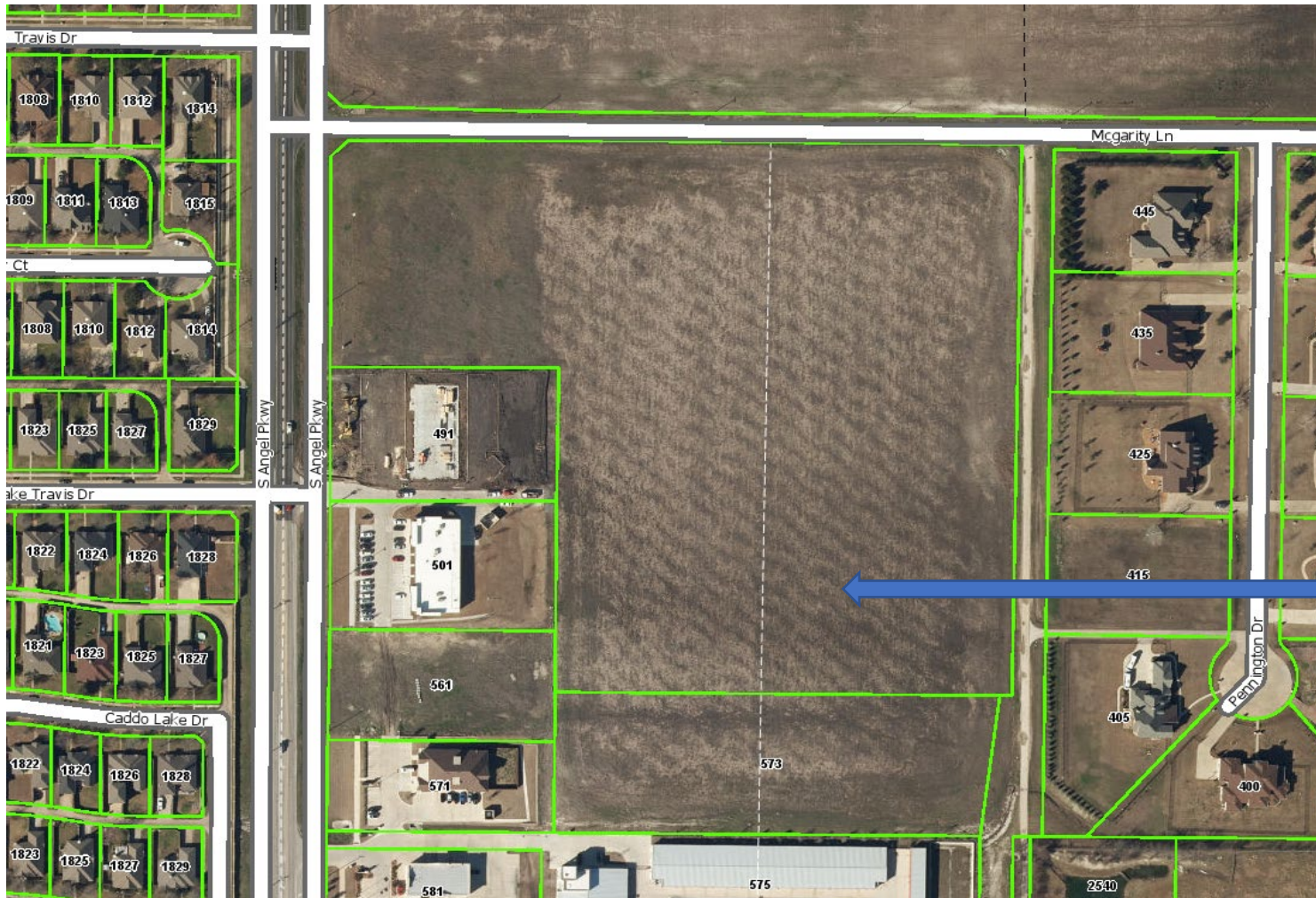

Tractor Supply



City of Lucas

Planning & Zoning Agenda Request

June 10, 2021

Item No. 02

Requester: Development Services Director Joe Hilbourn

Agenda Item Request

Review the City's submittal procedures and approval requirements relating to the platting process and provide direction to staff on any recommended amendments.

Background Information

At the June 3, 2021 City Council meeting, the platting process and requirements outlined in Article 10.03 of the Code of Ordinances, Subdivision and Development were discussed. The City Council has requested that the Planning and Zoning Commission review Article 10.03 as well as platting submission requirements to determine if any updates and/or revisions are needed. The City Council outlined specific areas within Article 10.03 that should be reviewed as well that include:

- Review and provide better description related to Section 10.03.039 (2)
- Review and determine appropriate location for Section 10.03.039 (E) and (F) as these items are not legally required for a preliminary plat.
- Review Section 10.03.040 (8) Data Requirements and determine if this should be moved to zoning requirements
- Review Section 10.03.040 (12) and determine if septic should be added

There was also discussion related to the Stormwater Design Manual used to determine the co-efficiency calculation for stormwater runoff before and after construction, and the creation of a checklist for staff detailing requirements that have been met in accordance with the ordinance for submission to the Planning and Zoning Commission.

Attachments/Supporting Documentation

1. Article 10.03 Subdivision and Development Ordinance
2. Preliminary and Final Plat Guide and application
3. Ordinance 2009-04-00644 Stormwater Planning and Design Criteria
4. Ordinance 2009-04-00645 Stormwater Runoff Regulations

Budget/Financial Impact

NA



City of Lucas
Planning & Zoning Agenda Request
June 10, 2021

Item No. 02

Recommendation

NA

Motion

NA

ORDINANCE REQUIREMENTS FOR PLATTING

ARTICLE 10.03 SUBDIVISION AND DEVELOPMENT ORDINANCE*

Division 1. General

Sec. 10.03.001 Title

This article shall be known and may be cited as “The City of Lucas Subdivision and Development Ordinance.”

Sec. 10.03.002 Authority

This article is adopted under the authority of the city charter, and the constitution and laws of the state, including chapters 43, 212 and 242 of the Texas Local Government Code, as amended.

Sec. 10.03.003 Purpose; plat required

(a) The purpose of this article is to: (i) provide for the orderly, safe and healthy development of the land within the city; (ii) protect and promote the health, safety, morals and general welfare of the city; (iii) guide the future growth and development of the city; (iv) provide for the proper location and width of streets and building lines; (v) provide adequate and efficient transportation, streets, storm drainage, water, wastewater, parks, and open space facilities; (vi) establish reasonable standards of design and procedures for platting to promote the orderly layout and use of land, and to insure proper legal descriptions and monumenting of platted land; (vii) insure that public infrastructure facilities required by city ordinances are available with sufficient capacity to serve the proposed development; (viii) require the cost of public infrastructure improvements that primarily benefit the tract of land being platted be borne by the owners of the tract.

(b) Every owner of any tract of land situated within the corporate limits of the city or within the extraterritorial jurisdiction of the city who divides the tract in two or more parts to lay out a subdivision of the tract, including an addition to the city, to lay out a building lot, or other lots, or to lay out streets, alleys, squares, parks or other parts of the tract intended to be dedicated to public use or for the use of purchasers or owners of lots fronting on or adjacent to the streets, alleys, squares, parks, or other parts must have a plat of the subdivision prepared and approved according to this article. A division of a tract under this article includes a division regardless of whether it is made by using a metes and bounds description in a deed of conveyance or in a contract for a deed, by using a contract of sale or other executing contract, or by using any other method. A division of land does not include a division of land into parts greater than 5 acres, where each part has access and no public improvement is dedicated.

(Ordinance 2006-07-00567, sec. 1, adopted 7/7/06)

(c) The procedure for approving a plat requires a preliminary plat and final plat. Except as otherwise permitted, the approval of a preliminary plat by the planning and zoning commission and city council is required for the construction of public improvements on the property. The preliminary plat and the associated engineering plans for the property may be amended during construction, with only major changes requiring reapproval by the planning and zoning commission. Upon completion of the required public improvements, or the provision of an improvement agreement, the owner may submit a corrected final plat for the subdivision. Lots may be sold and building permits obtained after approval of the final plat by the planning and zoning commission, and the recording thereof. (Ordinance 2010-11-00668, sec. 1, adopted 11/4/10)

Sec. 10.03.004 Applicability

This article shall apply to all subdivisions of land within the corporate limits of the city, and all land outside the corporate limits that the city council may annex, and all land within the extraterritorial jurisdiction of the city to the full extent allowed by state law. (Ordinance 2006-07-00567, sec. 1, adopted 7/7/06)

Sec. 10.03.037 Procedure for preliminary plat

(a) Prior to the filing of a preliminary plat, the developer shall meet with the city staff. The purpose of the meeting is to familiarize the developer with the city's development regulations and the relationship of the proposed subdivision to the comprehensive plan. At such meeting, the general character of the development, the zoning, utility service, street requirements and other pertinent factors related to the proposed subdivision will be discussed.

(b) Prior to submission of a preliminary plat, the developer shall submit to the city construction and engineering plans for the public infrastructure improvements required for the proposed subdivision unless the approval of an improvement agreement has been requested. If the city does not approve of the use of an improvement agreement, engineering and construction plans for the required public infrastructure must be submitted by the developer and approved by the city engineer prior to approval of the preliminary plat.

(c) After the preapplication conference and completion of engineering and construction plans for all public infrastructure improvements, the developer shall file the required number of copies of the preliminary plat of the proposed subdivision with the development review committee, for submission to the planning and zoning commission, and include the required filing fees and tax certificates showing all taxes have been paid on the property being platted.

(d) The following notice shall be stamped on the face of each preliminary plat: "Preliminary Plat - for inspection purposes only, and in no way official or approved for record purposes."

(e) Preliminary plats shall be distributed by city staff to city departments. The owner shall be responsible for the distribution of copies of the preliminary plats to the agencies listed below. The city staff shall give the owner and such agencies a specific date by which to return written responses. The owner and the agencies listed below shall be provided an opportunity to attend a developer/city staff conference for the purpose of notifying the developer of necessary corrections.

- (1) Independent school districts affected by the plat (one copy).
- (2) City utility departments (two copies).
- (3) Public utility companies and franchise utility companies that serve or will provide service to the proposed subdivision (two copies).
- (4) County commissioner and county public works director if the subdivision is outside the city limits (one copy each).

(f) The development review committee shall accumulate the comments of the city departments and agencies, and conduct a developer/city staff conference to report the comments and requested corrections to the developer. The developer shall be allowed to make comment or make required corrections and submit the corrected preliminary plat to the development review committee for submission to the planning and zoning commission. The corrected preliminary plat shall be submitted within thirty (30) days of the date the original preliminary plat was officially filed and prior to the meeting of the planning and zoning commission at which such preliminary plat is scheduled for consideration. Upon timely receipt, the planning and zoning manager shall submit the corrected preliminary plat to the planning and zoning commission.

(g) A written report shall be prepared by city staff and submitted to the planning and zoning commission stating the review comments of the preliminary plat noting any unresolved issues.

(h) Following review of the preliminary plat and other materials submitted in conformity with this article, the planning and zoning commission shall act on a preliminary plat, within thirty (30) days after the date the preliminary plat is officially filed. The planning and zoning commission may either: (i) approve the preliminary plat as presented; (ii) approve the preliminary plat with conditions; or (iii) disapprove the preliminary plat. If disapproved, the planning and zoning commission, upon written request, shall state the reasons for disapproval. A conditional approval shall be considered a disapproval until the conditions have been satisfied.

(i) The actions of the planning and zoning commission shall be noted on two (2) copies of the preliminary plat. One (1) copy shall be returned to the developer and the other retained in the files of the development review committee.

(j) The planning and zoning commission shall, in its action on the preliminary plat, consider the physical arrangement of the subdivision and determine the adequacy of the street and thoroughfare rights-of-way and alignment and the compliance of the streets and thoroughfares with the major thoroughfare plan, the existing street pattern in the area and with any other applicable provisions of the comprehensive zoning ordinance and comprehensive plan. The planning and zoning commission, based on city staff recommendations, shall also ascertain that adequate easements for proposed or future utility service and surface drainage are provided, and that the lot sizes and area comply with the comprehensive zoning ordinance and are adequate to comply with the minimum requirements for the type of sanitary sewage disposal proposed. All on-site sewage disposal systems shall meet the minimum standards required by the city plumbing code and the regulations of the county and of the state commission on environmental quality, or their successors.

(k) After approval of a preliminary plat by the planning and zoning commission, the development review committee shall forward the preliminary plat to the city council for consideration at the next available city council meeting.

(l) The city council shall act on the preliminary plat within thirty (30) days after the date the preliminary plat is approved by the planning and zoning commission or is considered approved by the inaction of the planning and zoning commission. A preliminary plat shall be considered approved by the city council unless it is disapproved within that period.

(m) Approval of a preliminary plat by the planning and zoning commission and/or the city council is not approval of the final plat but is an expression of approval of the layout shown subject to satisfaction of specified conditions. The preliminary plat serves as a guide in the preparation of a final plat.

(n) Expiration of preliminary plat approval. The approval of a preliminary plat expires 5 years after the date of city council approval unless a final plat is submitted and has received approval by the planning and zoning commission for the property within such period, or the period is extended by the planning and zoning commission upon written request of the owner. If the time period is not extended, or a final plat is not submitted and approved by the planning and zoning commission within the sixty-month period, the preliminary plat approval shall be null and void, and the owner shall be required to submit a new plat for the property subject to the then-existing zoning, subdivision and other regulations.

(o) Phased development. The preliminary plat shall indicate any phasing of the proposed development with a heavy dashed line. Each phase shall be numbered sequentially and in the proposed order of development. The proposed utility, street and drainage layout for each phase shall be designed in such a manner that the phases can be developed in numerical sequence. Thereafter, plats of subsequent units of such subdivision shall conform to the approved overall layout and phasing, unless a new preliminary plat is submitted. The planning and zoning commission and city council may impose such conditions upon the filing of the phases as deemed necessary to assure the orderly development of the city. Such conditions may include but are not limited to temporary street and alley extensions, temporary cul-de-sacs, turnarounds, and off-site utility extensions. Failure to indicate phasing of the proposed development in accordance with this section prohibits the approval of a final plat for such subdivision in phases.

(p) Effective period of preliminary plat approved for phased development. If a final plat has not been submitted and approved on at least one phase of the area covered by the preliminary plat 5 years after the date of preliminary plat approval, the preliminary plat shall expire and be declared null and void. If in the event that only a phase of the preliminary plat has been submitted for final plat approval, then the preliminary plat for those areas not final platted within two years of the date of preliminary plat approval shall expire and be declared null and void, unless an extension of time is granted by the planning and zoning commission. Any phase of a preliminary plat not receiving final plat approval within the period of time set forth herein shall expire and be declared null and void, and the owner shall be required to submit a new preliminary plat for approval which shall be subject to the then-existing zoning, subdivision and other regulations, and the payment of any applicable fees.

Sec. 10.03.038 Extension and restatement of expired preliminary plats

- (a) Sixty (60) days prior to or following the lapse of approval for a preliminary plat, as provided in these regulations, the owner may request the commission to extend or reinstate the approval.
- (b) In determining whether to grant such request, the commission shall take into account the reasons for lapse, the ability of the owner to comply with any conditions attached to the original approval and the extent to which newly adopted zoning and subdivision regulations shall apply to the preliminary plat. The commission may extend or reinstate the preliminary plat, or deny the request, in which instance the owner must submit a new preliminary plat application for approval.
- (c) The commission may extend or reinstate the approval subject to additional conditions based upon newly enacted regulations such as are necessary to issue [insure] compliance with the original conditions of approval. The commission may also specify a shorter time for lapse of the extended or reinstated preliminary plat than is applicable to original preliminary plat approval.

Sec. 10.03.039 Standards for approval of preliminary plats

No preliminary plat shall be approved unless the following standards have been met:

- (1) The engineering and construction plans for the required public infrastructure improvements have been submitted and approved by the city engineer, unless the approval of an improvement agreement has been requested and approved;
- (2) Provision for installation and dedication of public improvements has been made; and
- (3) The preliminary plat conforms to the applicable zoning and all other requirements of this article.

(Ordinance 2006-07-00567, sec. 1, adopted 7/7/06)

(4) (A) A tree survey, which identifies large trees with a DBH (“diameter at breast height” measured at 4.5 feet above grade) of four and one-half inches (4.5") or greater and small trees with a DBH of two inches (2") or greater, shall be submitted prior to submission of the engineering and construction plans. The tree survey shall include the species and caliper at DBH of each tree in a tabular form, with each tree identified by a number corresponding to a numbered tree on the tree survey site plan. The tree survey must denote which trees will be saved and which will be removed. (Ordinance 2006-07-00567, sec. 1, adopted 7/7/06; Ordinance adopting Code)

(B) The tree survey must be reviewed and approved by the planning and zoning commission prior to the preliminary plat being submitted and prior to staff approving the engineering and construction plans. The commission shall act on the tree survey within thirty (30) days after it is officially filed. If the commission does not approve the tree survey, that decision may be appealed to city council

for consideration at the next available city council meeting, and the city council shall act on the appealed tree survey within thirty (30) days after the date the tree survey was denied by the commission. Inaction by the city council within this period shall be considered as approval.

(C) The commission, or the council upon appeal, shall approve the tree survey if it finds and determines that the developer has made a good faith effort to save as many trees, 6" caliper or greater at DBH, as possible, given the subdivision layout, lot size, and topography of the proposed development.

(D) As part of the final plat application, the developer must submit to the planning department a spreadsheet that summarizes, for each lot, the number of trees that were to be saved per tree survey, as well as the number of trees to be saved that were lost during construction. The spreadsheet must denote the caliper inch and species of each tree saved, as well as for the trees to be saved, but lost during development. This will allow staff to verify how many replacement trees are needed for each lot at the building permit stage.

(Ordinance 2006-07-00567, sec. 1, adopted 7/7/06)

(E) Except as provided in section 3.18.005, no person, directly or indirectly, shall cut down, destroy, remove or move, or effectively destroy through damaging any protected tree situated on property regulated by article 3.18 without first obtaining a tree removal permit, unless otherwise specified in article 3.18. (Ordinance adopting Code)

(F) Then, prior to the final inspection in connection with a building permit, any tree(s) shown on the tree survey as being retained on the lot, and which is removed or lost during development of the lot or home, shall be replaced by the developer or builder by planting a tree or trees of equivalent caliper inches. The trees used as replacement trees must each have a caliper of at least one and one-half inches (1-1/2") and be container grown. Trees used as replacement trees must be from the large tree list found on the approved list in section 3.18.019 or approved by the planning and zoning manager. The replacement tree(s) must be planted on the same lot where the tree(s) it is replacing was, provided that the planning and zoning manager may approve placement of the tree(s) on another lot(s) in the subdivision, if he finds it to be in the public interest. (Ordinance 2006-07-00567, sec. 1, adopted 7/7/06; Ordinance adopting Code)

Sec. 10.03.040 Data requirement for preliminary plat

(a) The owner shall submit the required number of copies of the preliminary plat an [and] 8-1/2" x 11" and a 11" x 17" reduction of copies of the preliminary plat, as determined by the development review committee, to allow for the distribution of the proposed preliminary plat for review. Each copy of the preliminary plat shall be folded so that the title block for the subdivision may be read in the lower righthand corner. The preliminary plat shall be drawn to a scale of one-

inch equals one hundred feet (1" = 100') or larger on 24" x 36" sheet size. In cases of large developments which would exceed the dimensions of the required sheet at the 100-foot scale, preliminary plats may be submitted at a scale of one-inch equals two hundred feet (1" = 200') on multiple sheets, properly registered. (Ordinance 2006-07-00567, sec. 1, adopted 7/7/06)

(b) The preliminary plat shall contain or be accompanied by the following:

(1) The required number of copies of the preliminary plat and the approved engineering and construction plans for all public infrastructure improvements in accordance with the design standards of the city, to include all streets, water mains and services, sewer system and services, and drainage systems required to develop the proposed subdivision.

(Ordinance 2016-01-00827 adopted 1/7/16)

(2) The name, address and telephone number of the owner, the surveyor, and engineer responsible for the preparation of the final plat.

(3) The name of the subdivision, vicinity location map showing adjacent subdivisions, street names (which shall conform, whenever possible, to existing street names) and lot and block numbers in accordance with a systematic arrangement.

(4) An accurate boundary survey description of the property, with bearings and distances, referenced to survey lines, existing property descriptions and established subdivisions, and showing the lines of adjacent tracts, the layout, dimensions and names of adjacent streets and alleys and lot lines shown in dashed lines.

(5) Scale, north point, date, lot and block numbers.

(Ordinance 2006-07-00567, sec. 1, adopted 7/7/06)

(6) The name and location of adjacent subdivisions or unplatted tracts drawn to scale shown in dotted lines and in sufficient detail to accurately show the existing streets, alleys and other features that may influence the layout and development of the proposed subdivision. The abstract name and number, and name of the owner of the adjacent unplatted tracts shall be shown. (Ordinance 2016-01-00827 adopted 1/7/16)

(7) Exact location of lots, streets, public highways, alleys, parks and other features, with accurate dimensions in feet and decimal fractions of feet, with the length of radii and of arcs of all curves, internal angles, points of curvatures, length and bearings of the tangents, and with all other surveyor information necessary to reproduce the plat on the ground. Dimensions shall be shown from all angle points. All lots on building sites shall conform to the minimum standards for area, width and depth prescribed by the zoning district or districts in which the subdivision is located, and state the area size of each lot.

- (8) Building setback lines and the location of utility easements.
- (9) Topographic information showing contour lines with intervals up to one foot (1') indicating the terrain, the drainage pattern of the area, and the drainage basin areas within the proposed subdivision. Topographic information showing contour lines with intervals up to two (2) feet indicating the terrain, the drainage pattern of the area, and the drainage basin areas outside the boundaries of the proposed subdivision.
- (10) The layout and dimensions of proposed storm drainage areas, easements and rights-of-way necessary for drainage within and outside the boundaries of the proposed subdivision.
- (11) The location and purpose of all proposed parks or other areas offered for dedication to public use.
- (12) The location of all existing property lines, buildings, sewer or water mains, storm drainage areas, water and wastewater facilities, fire hydrants, gas mains or other underground structures, easements of record or other existing features.
- (13) The location, size and identification of any physical features of the property, including watercourses, ravines, bridges, culverts, existing structures, drainage or other significant topographic features located on the property or within one hundred fifty feet (150') of the proposed subdivision.
- (14) Copy of any deed restrictions, restrictive covenants, special use permit or planned development district ordinance regulating the property.
- (15) The angle of intersection of the centerlines of all intersecting streets which are intended to be less than ninety degrees (90°).
- (16) In accordance with the city floodplain management regulations, of the Code of Ordinances, as amended, the floodplain and floodway lines and base flood elevations as shown on the current effective flood insurance rate maps for the city shall be shown, where applicable. A notation shall be shown on the face of the preliminary plat stating: "Lots or portions of lots within the floodplain or areas of special flood hazard require a development permit prior to issuance of a building permit or commencement of construction including site grading, on all or part of those lots."
- (17) For a preliminary plat of land located outside the city limits where sanitary sewer does not exist or where street improvement standards vary from those specified by the city, such differences shall be noted.
- (18) A certificate of ownership and dedication of all streets, alleys, easements, parks and other land intended for public use, signed and acknowledged before a notary public by the owner and lienholders of the property, along with complete and accurate metes and bounds description of the land subdivided and the property dedicated to public use.

- (19) Receipt showing all taxes on the subject property are paid.
- (20) Certification by a surveyor, to the effect that the preliminary plat represents a survey made by the surveyor, and that all the necessary survey monuments are correctly shown thereon.
- (21) A preliminary plat provided in multiple sheets shall include a key map showing the entire subdivision at smaller scale with lot and block numbers and street names on one (1) of the sheets or on a separate sheet of the same size.

(Ordinance 2006-07-00567, sec. 1, adopted 7/7/06)

- (22) Copy of any proposed property owner or homeowners' association agreements, covenants and restrictions. (Ordinance 2016-01-00827 adopted 1/7/16)

Sec. 10.03.041 Effect of preliminary plat approval

Approval of a preliminary plat by the commission and city council constitutes authorization for the city engineer to release construction plans and to permit the owner to commence construction of the public improvements. Approval of a preliminary plat also authorizes the owner, upon fulfillment of all requirements and conditions of approval, to submit a final plat for approval. Upon release of the construction plans, the city engineer may, upon request of the applicant, issue a certificate indicating the construction plans have been released and construction of the improvement is thereafter authorized. The certificate shall read as follows:

“The Preliminary Plat for (insert name of the subdivision or addition) as approved by the City Council for the City of Lucas on (insert date of approval) is authorized for use with engineering plans for the construction of public improvements as approved by the City Engineer. A Final Plat shall be approved by the Planning and Zoning Commission upon the completion of all public improvements or the provision of an Improvement Agreement under the terms of the Subdivision and Development Ordinance and submission of a Final Plat in compliance with the Subdivision and Development Ordinance of the City of Lucas.”

2018

**Preliminary and Final
Plat Guide and Application
City of Lucas**



665 Country Club Road
Lucas Texas 75002

Office 972-912-1207
www.lucastexas.us



Office Use Only:
Date Received _____
Received by _____

APPLICATION

Name of Subdivision and/or Project: _____

ITEMS SUBMITTED

Filing Fee

Preliminary Plat

- Single Family Residential Subdivision Development
 - \$750 + \$5 per acre with 20 acres or less (i.e. \$850 for 20 acres) excluding minor plats of five (5) acres or less.
 - \$750 + \$5 per acre with 21-30 acres (i.e. \$900 for 30 acres)
 - \$800 + \$5 acre with 31-45 acres (i.e. \$1025 for 45 acres)
 - \$900 + \$5 per acre with 46+ acres (i.e. \$1130 for 46 acres)
- Estate Residential Subdivision Development
 - \$1000 + \$7 per acre for all size parcels (i.e. \$1140 for 20 acres)
- Minor Plats
 - \$500 + \$5 per acre with 5 acres or less (i.e. \$525 for 5 acres)
- Non-residential District Plats
 - \$800 + \$10 per acre with 30 acres or less
 - \$850 + \$10 per acre with 31 – 45 acres
 - \$950 + \$10 per acre with 46+ acres

Final Plat

- Single Family Residential Subdivision Development
 - \$800 + \$5 per acre with 30 acres or less
 - \$850 + \$5 per acre with 31 – 45 acres
 - \$950 + \$5 per acre with 46+ acres

Any additional development fees will be charged at final plat rates.
- Estate residential Subdivision Development
 - \$950 + \$7 per lot for all size parcels
- Minor Plat
 - \$350 + \$5 per acre with 5 acres or less
- Non-residential District Plats
 - \$850 + \$10 per acre for up to 30 acres
 - \$900 + \$10 per acre with 31 – 45 acres
 - \$1000 + \$10 per acre with 46+ acres
- Replat
 - Minor Plat (5 acres or less) \$450 + \$5 per acre (\$475 for 5 acres)
 - All others - \$600 + \$10 per acre
- Amended Plat
 - Minor Plats (5 acres or less) - \$300 + \$7 per acre (i.e. \$300 for an amended plat for 5 acres)
 - All others - \$500 + \$10 per acre (i.e. \$700 for an amended plat for 20 acres)

Storm Water Run-Off Permit

- Developments 0 – 3 acres \$75.00
- Developments 4 – 10 acres \$150.00
- Developments 10 acres and above \$500.00

Vacation of Plat

- \$500 + \$10 per acre

Concept Plan (Optional Land Study)

- \$150 per session with Planning & Zoning and/or Council

Tree Survey/Conservation Plan

N/A

Tree Removal & Site Clearing Permit

- \$ 250

Park Site Dedication

- \$ 1,000 per lot or land dedication per Lucas City Ordinance Sec. 10.01.122



APPLICATION, cont.

Physical Location of Property: _____
(Address and General Location – approximate distance to nearest existing street corner)

Brief Legal Description of Property (must also attach accurate metes and bounds description):

(Survey/Abstract No. and Tracts; or platted Subdivision Name with Lots/Block)

Comprehensive Zoning Designation/s: _____

Existing Zoning Designation/s: _____

Description of Project Uses: _____

Acreage: _____ Existing # of Lots/Tracts: _____

OWNER'S NAME: _____ Contact Phone: _____

Applicant/Contact Person: _____ Title: _____

Company Name: _____

Street/Mailing Address: _____

Phone: (_____) _____ Fax: (_____) _____ Email: _____

OWNER'S NAME: _____ Contact Phone: _____

Applicant/Contact Person: _____ Title: _____

Company Name: _____

Street/Mailing Address: _____

Phone: (_____) _____ Fax: (_____) _____ Email: _____

ENGINEER/REPRESENTATIVE': _____

Applicant/Contact Person: _____ Title: _____

Company Name: _____

Street/Mailing Address: _____

Phone: (_____) _____ Fax: (_____) _____ Email: _____



APPLICATION, cont.

Name of Subdivision or Project: _____ cont.

ALL APPLICATIONS MUST BE COMPLETE, ACCOMPANIED BY THE APPLICABLE CHECKLIST AND TAX CERTIFICATE SHOWING TAXES PAID, BEFORE THEY WILL BE SCHEDULED FOR P&Z AGENDA. It is the applicant's responsibility to be familiar with, and to comply with, all City submittal requirements (in the Zoning & Subdivision Ordinances, and any separate submittal policies, requirements and/or checklists that may be required from City staff), including the number of plans to be submitted, application fees, etc. Please contact City staff in advance for submittal requirements. [Drawings will not be returned to applicant.]

ALL PARCELS/PROPERTIES MUST MATCH IN ACREAGE ALL OTHER DOCUMENTS SUBMITTED WITH NO AMBIGUITY.

SUBMISSIONS: Failure to submit all materials to the City with this application will result in delays scheduling the agenda date.

NOTICE OF PUBLIC RECORDS: The submission of plans/drawings with this application makes such items public record, and the applicant understands that these items may be viewed by the general public. Unless the applicant expressly states otherwise in writing, submission of this application (with associated plans/drawings) will be considered consent by the applicant that the general public may view and/or reproduce (i.e., copy) such documents.

****READ BEFORE SIGNING BELOW:** If there should be more than one property owner complete a separate sheet with the same wording as below. The City requires all Original Signatures. If applicant is other than the property owner a "Power of Attorney" with original, notarized signatures are required. (Notaries are available)

ITEMS REQUIRED PRIOR TO FINAL PLAT APPROVAL:

- Applicant agrees to pay any and all monies due to the City including but not limited to Park Site fee, Tree Removal Permit fee, 3% of Construction cost (developer to provide contracts for verification) and including but not limited to other fees that may be required prior to final plat approval.
- Maintenance Bond for City Improvements, 2 year – 10% Bond to be verified by submitting contract.
- Construction as-built record drawings (mylar)
- Engineering construction test reports.
- Walk-through with Public Works personnel completed with satisfactory outcome.
- HOA (covenants, conditions & restrictions) documentation approved by City Attorney before submittal to Planning & Zoning.

By signing this application, staff is granted access to your property to perform work related to your case. I waive the statutory time limits in accordance with Section 212 of the Texas Local Government Code.

STATE OF TEXAS ()

COUNTY OF COLLIN ()

BEFORE ME, a Notary Public, on this day personally appeared _____ the undersigned applicant, who, under oath, stated the following: "I hereby certify that I am the owner, or duly authorized agent of the owner, (**proof must be attached, e.g. "Power of Attorney"**) for the purposes of this application; that all information submitted herein is true and correct. I understand that submitting this application does not constitute approval, and incomplete applications will result in delays and possible denial."

Owner / Agent (circle one)

[Notary seal]

SUBSCRIBED AND SWORN TO before me, this the _____ day of _____, _____.

Notary Public in and for the State of Texas: _____

Official Use Only:	Action Taken
Planning & Zoning: _____	Date: _____
City Council: _____	Date: _____
Applicant Withdrew: Yes or No	Applicant Made a Written Withdrawal: Yes or No
	Date: _____



PRELIMINARY AND FINAL PLAT Application Guide & Checklist

IMPORTANT NOTE

Applicants are **required** to schedule a **pre-application meeting** with the Community Development Department to discuss the development review/approval process and proposed plans with city staff. Application review submittal deadlines are **5 pm on the Thursday preceding the Wednesday DRC meeting**.

PLAT APPLICATION

The City is concerned about the time, expense and efforts you and City staff have or will put into your project. The checklists herein are provided to expedite the project review process, and to provide clear understanding as to what will be required, and what will be expected and evaluated. City staff is bound by City ordinance and State law regarding publishing of notices, mail-outs, etc. that will have an effect upon when your project will be heard by the approval body, which can only occur when the Plat Application and Plat are complete in all detail.

Please read the applicable checklist carefully. It is to be completed for all projects and, along with the associated Plat, is required to be complete in all details prior to acknowledgement by the City that the respective Plat is ready to proceed for approval. A Plat is considered filed with the City on the date of the hearing by the Planning and Zoning Commission or, if subject to administrative approval, when the Plat has been determined to meet all requirements. Instructions for completion are included with each checklist. Development regulations may be reviewed on the City's web site www.lucastexas.us.

The City has made every effort to evaluate historical plans and approvals to make sure that the checklist addresses all details needed on a Plan. Recognizing that no two projects sites are the same, and that Consultant's vary in their abilities, determination, experience, and quality control processes, the City may require that a plan or an element of the plan be redone, or that information not specifically addressed on the checklist be provided for a smoother review and approval process.

It is recognized that there most often will be changes needed from what is initially submitted to the City for review. City staff conscientiously examines each item on a checklist to see if the item was sufficiently addressed according to City requirements. Where deficiencies are found, the Plat will be marked up and returned to the contact person named on the application to be addressed prior to further review or acceptance.

IMPORTANT NOTICE

Due to recent legislation enacted by the 79th Texas legislature in 2005, the City is required to treat any original application, development plan or plat application as a formal permit application if the submittal gives the City fair notice of the proposed project and hence, according to Chapter 245 of the Texas Local Government Code, the City will treat such as a formal permit application as that term is defined under that Chapter and Ordinance No. 29-05. Once a permit application is received, the City will furnish a response to the applicant within 10 business days from the date of submittal to provide comments as to any deficiencies in the submittal. The applicant shall be given a total number of 45 days, commencing from the initial date of submittal, to make all corrections as noted, to provide a complete set of plans meeting submission requirements, and to correct any deficiencies. Failure of a resubmittal to meet all check list, ordinance and submission requirements upon the expiration of the 45-day period will result in the closure the file; the case shall become null and void, and the permit shall be deemed to be expired. Any further submittal will be treated as a new case and subject to existing requirements, together with required fees.

PLAT SUBMISSION REQUIREMENTS

1st or initial submittal:

- 2 (two)-24"x36" folded (approximately 8" x 12") copies of each Plan herein
- An electronic copy of the Plat and/or Exhibits in pdf format.
- 6 (six) 11" x 17" hardcopy reductions
- The completed checklist
- A completed application
- A letter requesting any variance, exception or modification to a regulation, or why an issue was not addressed
- A fee as required herein

2nd and 3rd submittals to address requirements:

- Highlight questions asked by DRC committee in bold.
- Provide response/correction directly below DRC question.
- 2 (two) 24"x36" folded copies of each Plat requiring corrections
- An electronic copy of the corrected Plat and/or Exhibits in pdf format.
- 6 (six) 11" x 17" hardcopy reductions

4th and subsequent submittal(s):

- 2 (two)-24"x36" folded (approximately 8" x 12") copies with required corrections.
- An electronic copy of the Plat and/or Exhibits in pdf format.
- 6 (six) 11" x 17" hardcopy reductions
- A fee equal to the original submission fee

When staff has determined the application is complete and accepted for final approval

- 30 (thirty) -24"x36" folded copies of Zoning Concept Plan and any/all other required Plan Exhibits
- 4 (twenty-four) -11"x17" Z folded copies.
- An electronic copy of the Plat and/or Exhibits in pdf format.
- Any changes made after Planning & Zoning review and before City Council review will require:
 - 15 – (fifteen) 24"x36" copies of each Plan, folded to approximately 8" x 12"
 - 4 (four) 11" x 17" or "12 x 18" reductions of each plan Tri or Z – folded.
 - An electronic copy of all Plans in pdf. format.

PLEASE REFER TO CITY OF LUCAS CODE OF ORDINANCE SEC.10.03.037 FOR FURTHER CLARIFICATION:

NOTES:

If a Facilities Agreement is required, such shall be approved by the City Council, and should be coordinated through the Department of Public Works – 972-912-1207.

Please note the signature requirements for Final Plats regarding mortgage holders, etc. At the submission of the approved Final Plat, prior to release of the Final Plat for filing with the respective County, the City shall require the following:

1. A certified copy of the Deed or Deed of Trust on file at the County Clerk's office, showing the owner of the property and, as applicable, the lien or mortgage holder(s) of the property to be platted. If the property was recently purchased and a copy of the Deed or Deed of Trust is not on file with the respective County, a signed and notarized copy of the Deed or Deed of Trust; and
2. A notarized Title Certificate issued within 14 days of Final Plat approval.



PRELIMINARY PLAT MINIMUM REQUIREMENTS CHECK LIST

Project Name _____ **Preparer** _____

This checklist is provided to assist you in addressing the minimum requirements for Preliminary Plat submission. Confirm that all information is included on the submitted plans by checking the box next to the required information. **Checking the box certifies to the City that you have completely and accurately addressed the issue. This completed form must be returned at the time of application submittal.**

If an exception or modification to the regulations is requested, the reason and/or request for each shall be provided both directly on the plan and on a separate sheet on letterhead with sufficient details as to allow a determination by the appropriate approving body. Additional information may be required. Reference the specific requirement.

Plans are to be submitted complete in all detail as shown by the checklist. Should plans be determined to be incomplete, they may either be returned to the applicant without further review or marked up with needed changes.

If a Preliminary Plat is required, a Tree Survey/Preservation Plan is also required as part of the submittal requirements with and at the time of Preliminary Plat submittal. Refer to the Development Plan Application packet for the needed application and checklist.

- I have made the decision NOT to waive the statutory time limits (30 days) in accordance with section 212 of the Texas Local Government Code. I understand and acknowledge that the City may DENY my Plat Application if not complete as determined by staff within the 30-day time period.
- The required number of copies of the preliminary plat and the approved engineering and construction plans for all public infrastructure improvements in accordance with the design standards of the City, to include all streets, water mains and services, sewer system and services, and drainage systems required to develop the proposed subdivision.
- The name, address and telephone number of the owner, the surveyor, and engineer responsible for the preparation of the final plat.
- The name of the Subdivision, Vicinity Location Map showing adjacent subdivisions, street names (which shall conform, whenever possible, to existing street names and be approved by the Post Office) and lot and blocks numbers in accordance with a systematic arrangement.
- An accurate boundary survey description of the property, with bearings and distances, referenced to survey lines, existing property descriptions and established subdivisions, and showing the lines of adjacent tracts, the layout, dimensions and names of adjacent streets and alleys and lot lines shown in dashed lines.
- Existing boundary of adjacent street, and alley rights-of-way and boundaries of right-of-way (ROW) dedication are indicated, street names are labeled, and ROW widths are dimensioned.
- Scale, north point, date, lot and block numbers.
- The name and location of adjacent subdivisions or unplatted tracts drawn to scale shown in dotted lines and in sufficient detail to accurately show the existing streets, alleys and other features that may influence the layout and development of the propose subdivision. The abstract name and number, and name of the owner of the adjacent unplatted tracts should be shown.
- Exact location of lots, streets, public highways, alleys, parks and other features, with accurate dimensions in feet and decimal fractions of feet, with the length of radii and of arcs of all curves, internal angles, points of curvatures, length and bearings of the tangents, and with all other surveyor information necessary to reproduce the plat on the ground. Dimensions shall be shown from all angle points.

- All lots on building sites shall conform to the minimum standards for area, width and depth prescribed by the zoning district or districts in which the subdivision is located, and state the area size of each lot. Internal lot lines are clearly indicated, shown to scale, and labeled with bearings and distances.
- Building setback lines and the location of utility easements.
- Topographic information showing contour lines with intervals up to one (1') foot indicating the terrain, the drainage pattern of the area, and the drainage basin areas **within** the proposed subdivision. Topographic information showing contour lines with intervals up to two (2) feet indicating the terrain, the drainage pattern of the area, and the drainage basin areas **outside** the boundaries of the proposed subdivision.
- The layout and dimensions of proposed storm drainage areas, easements and rights-of-way necessary for drainage within and outside the boundaries of the proposed subdivision.
- The location and purpose of all proposed parks or other areas offered for dedication to public use.
- The location of all existing property lines, buildings, sewer or water mains, storm drainage areas, water and wastewater facilities, fire hydrants, gas mains or other underground structures, easements of record or other existing features.
- The location, size and identification of any physical features of the property, including water courses, ravines, bridges, culverts, existing structures, drainage or other significant topographic features located on the property or within one hundred fifty feet (150') of the proposed subdivision.
- Copy of any deed restrictions, restrictive covenants, special use permit or planned development district ordinance regulating the property.
- The angle of intersection of the centerlines of all intersecting streets which are intended to be less than ninety (90°) degrees.
- In accordance with the city floodplain management regulations, of the Code of Ordinances, as amended, the floodplain and floodway lines and base flood elevations as shown on the current effective flood insurance rate maps for the city shall be shown, where applicable. A notation shall be shown on the face of the preliminary plat stating: "Lots or portions of lots within the floodplain or areas of special flood hazard require a development permit prior to issuance of a building permit or commencement of construction including site grading, on all or part of those lots".
- Floodplain and floodway lines and Base Flood Elevations as shown on the current effective Flood Insurance Rate Maps for the City should be shown, where applicable.
- For a preliminary plat of land located outside the city limits where sanitary sewer does not exist or where street improvement standards vary from those specified by the city, such differences shall be noted.
- A certificate of ownership and dedication of all streets, alleys, easements, parks and other land intended for public use, signed and acknowledged before a Notary Public by the owner and lien holders of the property, along with complete and accurate metes and bounds description of the land subdivided and the property dedicated to public use.
- Receipt showing all taxes on the subject property are paid.
- Certification by a surveyor, to the effect that the Preliminary Plat represents a survey made by the Surveyor, and that all the necessary survey monuments are correctly shown thereon.
- A Preliminary Plat, provided in multiple sheets shall include a key map showing the entire subdivision at smaller scale with lot and block numbers and street names on one (1) of the sheets or on a separate sheet of the same size.
- Copy of any proposed property owner or homeowners' association agreements, covenants and restrictions.
- Front and exterior side or corner setback lines are shown and labeled.
- Abstract lines, survey lines, county lines, school ISD boundary and corporate boundaries are shown and clearly labeled.
- A title block is provided in the lower right corner that includes large, boldly printed:

(SUBDIVISION NAME)
PRELIMINARY PLAT
LOT(S) _____, BLOCK(S) _____
 (survey, abstract and tract number)

If a replat, include:

REPLAT OF LOT(S) _____, BLOCK(S) _____

- A log of submittal/revision dates since submitted to the City.
- The purpose of a Replat or Amending Plat is stated on the face of the plat document.
- If the proposal is a replat or amending plat, the existing lot numbers and block numbers or letters are shown as light dotted lines, with lot number designation followed by R for Replats or an A for Amending Plats.
- Location of property lines, owner or subdivision name(s) and recording information of abutting properties is indicated. Unplatted property or any streets or alleys within a 500-ft radius of subject property are shown and identified/labeled as appropriate.
- Medians, median openings; turn lanes, deceleration/acceleration lanes and stacking distance is indicated within 200 feet of the property. The entire median, left-turn lane and/or deceleration lane and median opening serving a site is shown.
- Each lot is dimensioned and the square footage of each lot is indicated.
- Each lot is numbered and block groups are assigned a letter. Homeowner’s Association and other open space areas are identified with tract number.
- The location of existing underground and above ground utilities, flood plain boundaries and state or federally protected areas, such as wetlands, are indicated.
- The location of existing structures or other features proposed to remain and those proposed for removal.
- Existing easements are indicated by a light, dashed line and labeled indicating dimension, purpose and County recording information.
- Location, dimension, and purpose of proposed easements are indicated by a medium-weight, dashed line. Required and proposed ingress/egress or access easements are shown, clearly labeled and tied down, as appropriate.
- Existing zoning is shown.
- Location and area of parks, drainage ways, creeks and open space is indicated and labeled.
- Legal description/metes and bounds description is included.
- Include any notes required by the various affected agencies/utilities.
- Residential minor streets shall be designed and platted so that no street segment shall have a straight line for more than 1,000 feet before altering its course by at least 20 degrees.
- Sites to be reserved or dedicated for parks, playgrounds and/or other public uses are indicated and labeled.
- Preliminary water plans are included with this submittal.
- Contours are indicated with intervals of two (2) feet for property five acres or less and five (5) feet for property more than five acres.
- A note is included that states whether or not the property is in the 100-year flood plain, with the FIRM Community Panel reference number and map date.
- A note shall be added to the plat stating:

“Preliminary Plat - For Inspection Purposes Only.”

PLACE THE FOLLOWING ON ALL PLATS:

Requiring Planning and Zoning Commission Approval:

CITY APPROVAL CERTIFICATE

- ✓ This plat is hereby approved by the Planning and Zoning Commission of the City of Lucas, Texas

Chairman, Planning and Zoning Commission Date

ATTEST:

Signature Date

Name & Title

- ✓ The Director of Public Works of the City of Lucas, Texas hereby certifies that to the best of his/her knowledge or belief, this subdivision plat conforms to all requirements of the Code of Ordinances and with engineering construction standards and processes adopted by the City of Lucas, Texas as to which his/her approval is required.

Director of Public Works Date

- ✓ The Director of Planning and Community Development of the City of Lucas, Texas hereby certifies that to the best of his/her knowledge or belief, this subdivision plat conforms to all requirements of the Code of Ordinances, or as may have been amended or modified, as allowed, by the Planning and Zoning Commission as to which his/her approval is required.

Director of Planning and Community Development Date

SURVEYOR'S CERTIFICATION

- ✓ KNOW ALL MEN BY THESE PRESENTS:
That I, _____, do hereby certify, that I prepared this plat from an actual on the ground survey of the land as described and that the corner monuments shown thereon were properly placed under my personal supervision in accordance with the Platting Rules and Regulations of the City of Lucas Planning and Zoning Commission.

Registered Professional Surveyor
STATE OF TEXAS §
COUNTY OF DALLAS §

Before me, the undersigned authority, a Notary Public in and for said County and State, on this day personally appeared _____, known to me to be the person whose name is subscribed to the foregoing instrument and acknowledged to me that he/she executed the same for the purpose and considerations therein expressed.

Given under my hand and seal of office, this _____ day of _____, 200__.

Notary Public in and for
the State of Texas



FINAL PLAT MINIMUM REQUIREMENTS CHECK LIST

Project Name _____ **Preparer** _____

This checklist is provided to assist you in addressing the minimum requirements for Final Plat submission. An application is incomplete unless all applicable information noted below is submitted to the Department of Planning and Community Development. Confirm that all information is included on the submitted plans by checking the box next to the required information. **Checking the box certifies to the City that you have completely and accurately addressed the issue.** This completed form must be returned at the time of application submittal.

If an exception or modification to the regulations is requested, the reason and/or request for each shall be provided on a separate sheet on letterhead with sufficient details as to allow a determination by the appropriate approving body. Additional information may be required. Reference the specific requirement. All exception/modification requests must also be specifically listed on the plan/s.

Plans are expected to be submitted complete in all detail as included by the checklist. Should plans be determined to be incomplete, they may either be returned to the applicant without further review or marked up with needed changes.

If a Preliminary Plat was not required, a Tree Survey/Preservation Plan is required as part of the submittal requirements with and at the time of submittal of the Final Plat. Refer to the Development Plan Application for the needed application and checklist.

Included

- All information required for a Preliminary Plat.
- Record drawings, construction plans including one set of mylars and a digital copy in DWG or DGN format, and two sets of blueprints, where applicable.
- All information required for a preliminary plat.
- The improvement agreement and security if required, in a form satisfactory to the city attorney and in an amount established by the city council upon recommendation of the city engineer and shall include a provision that the owner shall comply with all the terms of the final plat approval as determined by the commission.
- Formal irrevocable offers of dedication to the public of all streets, alleys, utilities, easements and parks in a form approved by the city attorney.
- An owner may, at the discretion of the commission, obtain approval of a phase of a subdivision for which a preliminary plat was approved provided such phase meets all the requirements of this article in the same manner as is required for a complete subdivision.
- If applicable, copy of agreements, covenants and restrictions establishing and creating the homeowners' association approved by the commission based on recommendation of the city attorney.
- I have made the decision NOT to waive the statutory time limits (30 days) in accordance with section 212 of the Texas Local Government Code. I understand and acknowledge that the City may DENY my Plat Application if not complete as determined by staff within the 30-day time period.
- Location map clearly showing the location of the proposed Final Plat with cross streets is included. Indicate scale or not to scale (NTS) and provide north arrow.
- Written and bar graph scale and north arrow are indicated. North shall be oriented to the top or left side of the sheet.
- Abstract lines, survey lines, corporate boundaries are shown and clearly labeled.
- A title block is provided in the lower right corner that includes large, boldly printed

(SUBDIVISION NAME)

FINAL PLAT (or REPLAT, AMENDING PLAT, MINOR PLAT as applicable)

LOT(S) _____, BLOCK(S) _____

(survey, abstract and tract number)

If a replat, include:

REPLAT OF LOT(S) _____, BLOCK(S) _____

- The owner and surveyor's names, addresses and phone numbers, gross and net areas as applicable, submission date, and a log of submittal/revision dates since submitted to the City.
- Location of property lines, owner or subdivision name(s) and recording information of abutting properties is shown.
- Abutting properties are indicated by a light solid line.
- Existing boundary of street rights-of-way adjacent to the property and boundaries of right-of-way dedication are indicated by a medium weight solid line, intermittent with two dashed lines, and widths are dimensioned.
- Existing and proposed internal alleys and streets ROW are indicated by a medium weight solid line, intermittent with two dashed lines.
- Streets are named and ROW dimensioned.
- Streets and alleys ROW within 200 feet of the subject property boundary are accurately located, dimensioned, and named/labeled.
- Residential minor streets shall be designed and platted so that no street segment shall have a straight line for more than 1,000 feet before altering its course by at least 20 degrees.
- The length and bearing of all straight lines, radii, arc lengths, tangent length and central angles of all curves are indicated along the lines of each lot. The curve data pertaining to block or lot boundary may be placed in a curve table at the base of the plat and prepared in a tabular form with the following information:
 - a. Curve number
 - b. Delta
 - c. Radius
 - d. Tangent length
 - e. Tangent offset
 - f. Arc length
 - g. Chord
- The description and location of all survey monuments placed in the subdivision or immediately adjacent to it are shown.
- In all subdivisions, corners are established at the corner of each block in the subdivision consisting of an iron rod or pipe not less than three-quarter inches (3/4") in diameter and twenty-four inches (24") deep, flush with the top of the sidewalk or other paving, surface, etc. All lot corners shall be installed prior to the final inspection of the subdivision.
- Lot corner monuments are placed at all lot corners except corners which are also block corners, consisting of iron rods or pipes of a diameter of not less than one-half inch (1/2") and eighteen inches (18") deep set flush with the top of the sidewalk. All lot corners shall be installed prior to the final inspection of the subdivision.
- Curve point markers are established using the same specifications as lot corners. All lot corners shall be installed prior to the final inspection of the subdivision.
- Internal lot lines are clearly indicated and shown to scale.
- Each lot is dimensioned with bearings and distances, as applicable, and the square footage of each lot is indicated.
- Each lot is numbered and block groups are assigned a letter.
- The location of flood plain boundaries and state or federally protected areas, such as wetlands, are indicated.
- Existing easements are indicated by a light, dashed line and labeled indicating dimension, purpose, and County recording information.
- Proposed easements are indicated by a medium weight, dashed line and labeled indicating dimension and purpose.

PLACE THE FOLLOWING ON FINAL PLATS AS APPLICABLE:

**SAMPLE OWNER’S CERTIFICATE
(If no homeowners’ association is involved)**

STATE OF TEXAS §
COUNTY OF COLLIN §

WHEREAS, John Doe and Joe Dokes are the Owners of a tract of land situated in the J. Foreman Survey, Abstract No. 483, Dallas County, Texas and being out of a 40 acre tract conveyed to them by Joe Smith and Tom Smith and a 0.54 acre tract conveyed to them by Jim Henry and being more particularly described as follows:

(Enter accurate property description here)

NOW THEREFORE, KNOW ALL MEN BY THESE PRESENTS:

That I/we, *John Doe, Joe Dokes*, Owners, do hereby bind themselves and their heirs, assignees and successors of title this plat designating the hereinabove described property as *New Town Estates*, an addition to the City of Lucas, and do hereby dedicate to the public use forever the streets, alleys, and right-of-way easements shown thereon, and do hereby reserve the easement strips shown on this plat for the mutual use and accommodation of garbage collection agencies and all public utilities desiring to use or using same. Any public utility shall have the right to remove and keep removed all or part of any buildings, fences, trees, shrubs, or other improvements or growths that in any way endanger or interfere with the construction, maintenance or efficiency of its respective systems on any of these easements strips, and any public utility shall at all times have the right of ingress and egress to and from and upon the said easement strips for the purpose of constructing, reconstructing, inspecting, patrolling, without the necessity at any time of procuring the permission of anyone. Additionally, I/we certify that I/we (*indicate correct options*) are the sole owners of the dedicated property and that no other’s interest are attached to this property unless otherwise indicated on the required Mortgage Holder Certification that is included on this plat. This plat approved subject to all platting ordinances, rules, regulations and resolutions of the City of Lucas, Texas.

Witness our hands at *LUCAS*, Texas, this _____ day of _____, 200__.

Joe Dokes, Owner

John Doe, Owner

STATE OF TEXAS §
COUNTY OF COLLIN §

Before me, the undersigned authority, a Notary Public in and for said County and State, on this day personally appeared *John Doe and Joe Dokes*, Owners, known to me to be the persons whose names are subscribed to the foregoing instrument and acknowledged to me that they each executed the same for the purpose and considerations therein expressed.

Given under my hand and seal of office, this _____ day of _____, 200__.

Notary Public in and for
the State of Texas

**MORTGAGE HOLDER CERTIFICATION
(If no homeowners’ association is involved)**

That I, _____, hold a mortgage or represent holders of a mortgage on the described property herein, do hereby consent to the submission and filing of this plat designating the hereinabove described property as *New Town Estates*, an addition to the City of Lucas and do hereby dedicate to the public use forever the streets, alleys, and right-of-way easements shown thereon and do hereby reserve the easements shown on this plat for the mutual use and accommodation of garbage collection agencies, public utilities desiring to use or using same and fire and access easements. Any public utility shall have the right to remove and keep removed all or part of any buildings, fences, trees, shrubs, or other improvements or growths which in any way endanger or interfere with the construction, maintenance or efficiency of its respective systems on any of these easements and any public utility shall at all times have the right of ingress and egress to and from and upon the said easement strips for the purpose of constructing, reconstructing, inspecting, patrolling, without the necessity at any time of procuring the permission of anyone. This plat approved subject to all platting ordinances, rules, regulations and resolutions of the City of Lucas, Texas.

Witness our hands at, Texas, this _____ day of _____, 200__.

Signature

Title

Company

STATE OF TEXAS §

COUNTY OF COLLIN §

Before me, the undersigned authority, a Notary Public in and for said County and State, on this day personally appeared _____, known to me to be the person whose name is subscribed to the foregoing instrument and acknowledged to me that he/she executed the same for the purpose and considerations therein expressed. Given under my hand and seal of office, this _____ day of _____, 200_____.

Notary Public in and for the State of Texas

**SAMPLE OWNER’S CERTIFICATE
(If a homeowners’ association is involved)**

STATE OF TEXAS §
COUNTY OF COLLIN §

WHEREAS, *John Doe and Joe Dokes* are the Owners of a tract of land situated in the *J. Foreman Survey, Abstract No. 483, Dallas County, Texas* and being out of a *40 acre tract conveyed to them by Joe Smith and Tom Smith* and a *0.54 acre tract conveyed to them by Jim Henry* and being more particularly described as follows: 15

(Enter accurate property description here)

NOW THEREFORE, KNOW ALL MEN BY THESE PRESENTS:

That I/we, *John Doe, Joe Dokes*, Owners, do hereby bind themselves and their heirs, assignees and successors of title this plat designating the hereinabove described property as *New Town Estates*, an addition to the City of Lucas, and do hereby dedicate to the public use forever the streets, alleys, and right-of-way easements shown thereon, and do hereby reserve the easement strips shown on this plat for the mutual use and accommodation of garbage collection agencies and all public utilities desiring to use or using same. Any public utility shall have the right to remove and keep removed all or part of any buildings, fences, trees, shrubs, or other improvements or growths that in any way endanger or interfere with the construction, maintenance or efficiency of its respective systems on any of these easements strips, and any public utility shall at all times have the right of ingress and egress to and from and upon the said easement strips for the purpose of constructing, reconstructing, inspecting, patrolling, without the necessity at any time of procuring the permission of anyone. Additionally, I/we certify that I/we are the sole owners of the dedicated property and that no other’s interest is attached to this property unless otherwise indicated on the required Mortgage Holder Certification that is included on this plat.

Furthermore, as the owner of the property described herein, and in consideration of establishing the subdivision described herein, I/we agree to the following:

- Every owner of fee simple title to every individual lot within the subdivision shall be a member of the homeowners’ association;
- The homeowners’ association shall have the authority to collect membership fees;
- As applicable as it pertains to conditions shown herein, the homeowners’ association shall be responsible for the maintenance of all common areas, screening walls, landscaped areas, private streets and alleys.
- The homeowners’ association shall grant the City the right of access to any areas to abate any nuisances on such areas, and attach a lien upon each individual lot for the prorated costs of abatement.
- The homeowners’ association shall indemnify and hold the City harmless from any and all costs, expenses, suits, demands, liabilities, damages, or otherwise, including attorney fees and costs of suit, in connection with the City’s maintenance of common areas.
- The homeowners’ association shall, where additional rights-of-way has been dedicated for the purpose of providing landscaping, additional areas for sidewalks, walls or other amenities, enter into a license agreement with the City and shall be responsible for the installation and maintenance of all landscape areas in the public rights-of-way.

This plat approved subject to all platting ordinances, rules, regulations and resolutions of the City of Lucas, Texas.

Signature of Owner

STATE OF TEXAS §
COUNTY OF COLLIN §

Before me, the undersigned authority, a Notary Public in and for said County and State, on this day personally appeared *John Doe and Joe Dokes*, Owners, known to me to be the persons whose names are subscribed to the foregoing instrument and acknowledged to me that they each executed the same for the purpose and considerations therein expressed.

Given under my hand and seal of office, this _____ day of _____, 200_____.

Notary Public in and for
The State of Texas

MORTGAGE HOLDER CERTIFICATION
(If a homeowners' association is involved)

That I, _____, hold a mortgage or represent holders of a mortgage on the described property herein, do hereby consent to the submission and filing of this plat designating the hereinabove described property as *New Town Estates No. 2*, an addition to the City of Lucas and do hereby dedicate to the public use forever the streets, alleys, and right-of-way easements shown thereon and do hereby reserve the easement strips shown on this plat for the mutual use and accommodation of garbage collection agencies and all public utilities desiring to use or using same. Any public utility shall have the right to remove and keep removed all or part of any buildings, fences, trees, shrubs, or other improvements or growths which in any way endanger or interfere with the construction, maintenance or efficiency of its respective systems on any of these easements strips and any public utility shall at all times have the right of ingress and egress to and from and upon the said easement strips for the purpose of constructing, reconstructing, inspecting, patrolling, without the necessity at any time of procuring the permission of anyone. This plat approved subject to all platting ordinances, rules, regulations and resolutions of the City of Lucas, Texas, and to requirements placed on the homeowners' association as indicated herein and remedies to the abatement of nuisance and liens on properties therein and as required.

Witness our hands at, Texas, this _____ day of _____, 200__.

Signature

Title

Company

STATE OF TEXAS §
COUNTY OF COLLIN §

Before me, the undersigned authority, a Notary Public in and for said County and State, on this day personally appeared _____, known to me to be the person whose name is subscribed to the foregoing instrument and acknowledged to me that he/she executed the same for the purpose and considerations therein expressed.

Given under my hand and seal of office, this _____ day of _____, 200__.

Notary Public in and for
The State of Texas

City Filing Requirements:

- 3 (three)-24"x36" mylar with original seals and signatures, stamped with County recording information
- 4 (four) 11" x 17" black and white copies
- 1-Original tax certificate for the platted property
- Collin County Plat Recording Requirements (Verify with the Collin County Clerk at 972-542-4185) and applicable fees plus 15% administrative fee.



Lucas Code of Ordinances

Sec. 10.03.037 Procedure for preliminary plat

(e) Preliminary plats shall be distributed by city staff to city departments. The owner shall be responsible for the distribution of copies of the preliminary plats to the agencies listed below. The city staff shall give the owner and such agencies a specific date by which to return written responses. The owner and the agencies listed below shall be provided an opportunity to attend a developer/city staff conference for the purpose of notifying the developer of necessary corrections.

- (1) Independent school districts affected by the plat (one copy).
- (2) City utility departments (two copies).
- (3) Public utility companies and franchise utility companies that serve or will provide service to the proposed subdivision (two copies).
- (4) County commissioner and county public works director if the subdivision is outside the city limits (one copy each).

Dear Land Owner,

Below is a list of contacts compiled to help you comply with the City of Lucas Code of Ordinance, Sec. 10.03.037. This list was compiled only as a guide, proof of compliance falls with you, the owner.

- (1) Independent school districts affected by the plat (one copy).

I. **Allen ISD:**

Tim Carroll - Director of Public Information

972-727-0510 ext. 217

tim_carroll@allenisd.org

601 E. Main Street

Allen, TX 75002

II. **Lovejoy ISD:**

Dennis Womack – Director of Communication

469-742-8017

Dennis_womack@lovejoyisd.net

259 Country Club Road

Allen, TX 75002

III. **McKinney ISD:**

Nancy James – Assistant Superintendent for Support Services
469-742-4113

nsjames@mckinneyisd.net

1 Duvall Street
McKinney, TX 75069

IV. **Plano ISD:**

Steve Fortenberry – Chief Financial Officer, Business Services
469-752-8023

steve.fortenberry@pisd.edu

2700 W. 15th Street
Plano, TX 75075

Pam Moreland - Administrative Assistant-Student Records
469-752-8080

pam.moreland@pisd.edu

2700 W. 15th Street
Plano, TX 75075

V. **Princeton ISD:**

Phillip Anthony – Superintendent
469-952-5400

panthony@princetonisd.net

321 Panther Parkway
Princeton, TX 75407

VI. **Wylie ISD:**

Ian Halperin – Director of Communications & Community Relations
972-429-3019

ian.halperin@wylieisd.net

P.O. Box 490
Wylie, TX 75098

- (2) City utility departments (two copies).

Facilitated by City of Lucas Staff

- (3) Public utility companies and franchise utility companies that serve or will provide service to the proposed subdivision (two copies).

Grayson-Collin Electric:

Michael Lauer – Project Manager & Manager of Economic Development
903-482-7183

Michael.lauer@grayson-collin.coop

P.O. Box 548

Van Alstyne, TX 75495

TXU Energy:

Brian Neitzel – Director of Real Estate & Development

214-812-4600

frianneitzel@txu.com

1601 Bryan Street

Dallas, TX 75201

North Texas Municipal Water District

Bobby Schalf – Assistant Planning Officer

Phone (Local): 972-442-5405

Fax: 972-295-6440

bschalf@ntmwd.com

505 East Brown Street

Wylie, TX 75098

Co-Serve

Lance Ehler – Business Developer Manager

Phone: 940-321-7862

Fax: 940-321-7814

lehler@coserv.com

7701 South Stemmons

Corinth, TX 76210-1842

Oncor

Steve Elk – Area Manager

Phone: 972-569-1205

Fax: 972-569-1299

Steven.elk@oncor.com

4600 State HWY 121

Mckinney, TX 75070

- (4) County commissioner and county public works director if the subdivision is outside the city limits (one copy each).

Phyllis Cole – Collin County Commissioner

Phone: 972-424-1460 ext. 4628

Fax: 972-548-4699

pcole@collincountytx.gov

Collin County Government Center

210 S. McDonald St.

Suite 626
McKinney, TX 75069

Jon Kleinheksel - Collin County Public Works
Phone (Local): 972-548-3700
Phone (Metro): 972-424-1460 ext. 3700
Fax: 972-548-3754
pubworks@collincountytx.gov
700 A. Wilmeth Rd
McKinney, TX 75069

Tracy Homfeld - Collin County Engineering
Phone (Local): 972-548-3733
Phone (Metro): 972-424-1460 ext. 3733
Fax: 972-548-5555
thomfeld@collincountytx.gov
825 North McDonald Street
Suite 160
McKinney, TX 75069

I have complied with Lucas City Ordinance Sec. 10.03.037

Development Name

Agents Signature

Date

Notary

Date



Concept Plan (Optional Land Study) Minimum Requirements

Project Name _____ **Preparer** _____

This checklist is provided to assist you in addressing the minimum requirements for **Optional Land Study** submission. An application is incomplete unless all applicable information noted below is submitted to the Department of Planning and Community Development. Confirm that all information is included on the submitted plans by checking the box next to the required information. **Checking the box certifies to the City that you have completely and accurately addressed the issue.** This completed form must be returned at the time of application submittal.

If an exception or modification to the regulations is requested, the reason and/or request for each shall be provided on a separate sheet on letterhead with sufficient details as to allow a determination by the appropriate approving body. Additional information may be required. Reference the specific requirement. All exception/modification requests must also be specifically listed on the plan/s.

Plans are expected to be submitted complete in all detail as included by the checklist. Should plans be determined to be incomplete, they may either be returned to the applicant without further review or marked up with needed changes.

Prior to submission of a preliminary plat and after meeting with the city staff, the owner may file an application for approval of an optional land study with the commission, which shall meet the following minimum requirements:

Application for the needed application and checklist.

Included

- The application shall include all contiguous holdings of the owner with an indication of the portion which is proposed to be developed or offered, sold or leased, accompanied by an affidavit of ownership, which includes an address and telephone number of an agent.
- The optional land study shall be drawn to scale of 1" = 100' or larger.
- The lower right-hand corner of the optional land study shall contain a title block clearly showing the proposed name of the subdivision or addition, the name and address of the owner, engineer or surveyor responsible for the design or survey, the scale of the drawing, the date the drawing was prepared, and the location of the tract according to the abstract and survey records of the county.
- The optional land study shall clearly show the limits of the tract and scale distances. True north shall be clearly indicated and shall be to the top or left of the study.
- The optional land study shall show the names of adjacent subdivisions or additions or the name of record owners or [of] adjoining parcels of unplatted land.
- The optional land study shall contain the existing zoning on adjoining land, the location, width, and names of all existing or platted streets or other public ways within or adjacent to the tract, existing permanent buildings, railroad rights-of-way, and topography with existing drainage channels or creeks, and other important features such as tree groupings, vegetation, political subdivisions or corporate limits and school district boundaries.
- The optional land study shall show the layout, names and width of proposed streets, alleys and easements.

- The optional land study shall show a general arrangement of land uses including but not limited to park and school sites, municipal facilities, private open space, floodplains and drainage ways, phasing plan, and proposed nonresidential and residential uses and densities.
- The optional land study shall show layout, numbers, and approximate dimensions of proposed lots and all building lines.
- The optional land study shall show the location of proposed screening walls and/or other forms of screening shall be clearly indicated.
- The optional land study shall show existing contours of the tract in intervals of two feet or less, referred to sea level datum.
- The optional land study shall show existing sewers, water mains, culverts, or other underground structures within the tract and immediately adjacent thereto with pipe sizes and locations indicated.
- The optional land study shall show proposed water, sanitary sewer and storm sewer pipelines with culverts, bridges, and other appurtenances or structures shown.
- The optional land study shall show storm water retention or detention basins as required.
- The optional land study shall show erosion mitigation of lots or roads next to creeks and drainage ways according to drainage and erosion guidelines from the engineering department.
- Record drawings, construction plans including one set of mylars



OPTIONAL LAND STUDY

Office Use Only:

Date Received

Received by

Name of Subdivision and/or Project: _____

ITEMS SUBMITTED

Filing Fee

Preliminary Plat

- Single Family Residential Subdivision Development
 - \$750 + \$5 per acre with 20 acres or less (i.e. \$850 for 20 acres) excluding minor plats of five (5) acres or less.
 - \$750 + \$5 per acre with 21-30 acres (i.e. \$900 for 30 acres)
 - \$800 + \$5 per acre with 31-45 acres (i.e. \$1025 for 45 acres)
 - \$900 + \$5 per acre with 46+ acres (i.e. \$1130 for 46 acres)
- Estate Residential Subdivision Development
 - \$1000 + \$7 per acre for all size parcels (i.e. \$1140 for 20 acres)
- Minor Plats
 - \$500 + \$5 per acre with 5 acres or less (i.e. \$525 for 5 acres)
- Non-residential District Plats
 - \$800 + \$10 per acre with 30 acres or less
 - \$850 + \$10 per acre with 31 – 45 acres
 - \$950 + \$10 per acre with 46+ acres

Final Plat

- Single Family Residential Subdivision Development
 - \$800 + \$5 per acre with 30 acres or less
 - \$850 + \$5 per acre with 31 – 45 acres
 - \$950 + \$5 per acre with 46+ acres

Any additional development fees will be charged at final plat rates.
- Estate residential Subdivision Development
 - \$950 + \$7 per lot for all size parcels
- Minor Plat
 - \$350 + \$5 per acre with 5 acres or less
- Non-residential District Plats
 - \$850 + \$10 per acre for up to 30 acres
 - \$900 + \$10 per acre with 31 – 45 acres
 - \$1000 + \$10 per acre with 46+ acres
- Replat
 - Minor Plat (5 acres or less) \$450 + \$5 per acre (\$475 for 5 acres)
 - All others - \$600 + \$10 per acre
- Amended Plat
 - Minor Plats (5 acres or less) - \$300 + \$7 per acre (i.e. \$300 for an amended plat for 5 acres)
 - All others - \$500 + \$10 per acre (i.e. \$700 for an amended plat for 20 acres)

Storm Water Run-Off Permit

- Developments 0 – 3 acres \$75.00
- Developments 4 – 10 acres \$150.00
- Developments 10 acres and above \$500.00

Vacation of Plat

- \$500 + \$10 per acre

Concept Plan (Optional Land Study)

- \$150 per session with Planning & Zoning and/or Council

Tree Survey/Conservation Plan

N/A

Tree Removal & Site Clearing Permit

- \$ 250

Park Site Dedication

- \$ 1,000 per lot or land dedication per Lucas City Ordinance Sec. 10.01.122



OPTIONAL LAND STUDY, cont.

Physical Location of Property: _____
(Address and General Location – approximate distance to nearest existing street corner)

Brief Legal Description of Property (must also attach accurate metes and bounds description):

(Survey/Abstract No. and Tracts; or platted Subdivision Name with Lots/Block)

Comprehensive Zoning Designation/s: _____

Existing Zoning Designation/s: _____

Description of Project Uses: _____

Acreage: _____ Existing # of Lots/Tracts: _____

OWNER'S NAME: _____ Contact Phone: _____

Applicant/Contact Person: _____ Title: _____

Company Name: _____

Street/Mailing Address: _____

Phone: (_____) _____ Fax: (_____) _____ Email: _____

OWNER'S NAME: _____ Contact Phone: _____

Applicant/Contact Person: _____ Title: _____

Company Name: _____

Street/Mailing Address: _____

Phone: (_____) _____ Fax: (_____) _____ Email: _____

ENGINEER/REPRESENTATIVE': _____

Applicant/Contact Person: _____ Title: _____

Company Name: _____

Street/Mailing Address: _____

Phone: (_____) _____ Fax: (_____) _____ Email: _____



OPTIONAL LAND STUDY, cont.

Name of Subdivision or Project: _____ cont.

ALL APPLICATIONS MUST BE COMPLETE, ACCOMPANIED BY THE APPLICABLE CHECKLIST AND TAX CERTIFICATE SHOWING TAXES PAID, BEFORE THEY WILL BE SCHEDULED FOR P&Z AGENDA. It is the applicant's responsibility to be familiar with, and to comply with, all City submittal requirements (in the Zoning & Subdivision Ordinances, and any separate submittal policies, requirements and/or checklists that may be required from City staff), including the number of plans to be submitted, application fees, etc. Please contact City staff in advance for submittal requirements. [Drawings will not be returned to applicant.]

ALL PARCELS/PROPERTIES MUST MATCH IN ACREAGE ALL OTHER DOCUMENTS SUBMITTED WITH NO AMBIGUITY.

SUBMISSIONS: Failure to submit all materials to the City with this application will result in delays scheduling the agenda date.

NOTICE OF PUBLIC RECORDS: The submission of plans/drawings with this application makes such items public record, and the applicant understands that these items may be viewed by the general public. Unless the applicant expressly states otherwise in writing, submission of this application (with associated plans/drawings) will be considered consent by the applicant that the general public may view and/or reproduce (i.e., copy) such documents.

****READ BEFORE SIGNING BELOW:** If there should be more than one property owner complete a separate sheet with the same wording as below. The City requires all Original Signatures. If applicant is other than the property owner a "Power of Attorney" with original, notarized signatures are required. (Notaries are available)

ITEMS REQUIRED PRIOR TO FINAL PLAT APPROVAL:

- Applicant agrees to pay any and all monies due to the City including but not limited to Park Site fee, Tree Removal Permit fee, 3% of Construction cost (developer to provide contracts for verification) and including but not limited to other fees that may be required prior to final plat approval.
- Maintenance Bond for City Improvements, 2 year – 10% Bond to be verified by submitting contract.
- Construction as-built record drawings (mylar)
- Engineering construction test reports.
- Walk-through with Public Works personnel completed with satisfactory outcome.
- HOA (covenants, conditions & restrictions) documentation approved by City Attorney before submittal to Planning & Zoning.

By signing this application, staff is granted access to your property to perform work related to your case. I waive the statutory time limits in accordance with Section 212 of the Texas Local Government Code.

STATE OF TEXAS ()

COUNTY OF COLLIN ()

BEFORE ME, a Notary Public, on this day personally appeared _____ the undersigned applicant, who, under oath, stated the following: "I hereby certify that I am the owner, or duly authorized agent of the owner, (**proof must be attached, e.g. "Power of Attorney"**) for the purposes of this application; that all information submitted herein is true and correct. I understand that submitting this application does not constitute approval, and incomplete applications will result in delays and possible denial."

Owner / Agent (circle one)

[Notary seal]

SUBSCRIBED AND SWORN TO before me, this the _____ day of _____, _____.

Notary Public in and for the State of Texas: _____

Official Use Only:

Action Taken

Planning & Zoning: _____ Date: _____

City Council: _____ Date: _____

Applicant Withdrew: Yes or No

Applicant Made a Written Withdrawal: Yes or No

Date: _____

<input type="checkbox"/>	Annexation
<input type="checkbox"/>	Disannexation
<input checked="" type="checkbox"/>	Code of Ordinances
<input type="checkbox"/>	Other

**ORDINANCE # 2009-04-00644
[PLANNING & DESIGN CRITERIA FOR
STORMWATER RUN-OFF]**

THE CITY COUNCIL OF LUCAS, TEXAS APPROVES THE ADOPTION OF A PLANNING AND DESIGN DRAINAGE CRITERIA FOR STORM WATER RUN-OFF TO BE MAINTAINED ON FILE IN THE OFFICE OF THE CITY SECRETARY; PROVIDING A SEVERABILITY CLAUSE; PROVIDING A REPEALING CLAUSE; PROVIDING FOR A PENALTY OR FINE NOT TO EXCEED THE SUM OF TWO THOUSAND DOLLARS (\$2,000) FOR OFFENSES; AND PROVIDING AN EFFECTIVE DATE.

WHEREAS, the City Council has determined an urgent need for the adoption of guidelines for storm water run-off;

WHEREAS, the City Council desires to adopt the Planning and Design Drainage Criteria for storm water run-off attached hereto as Exhibit "A."

NOW, THEREFORE, BE IT ORDAINED THAT THE CITY COUNCIL OF THE CITY OF LUCAS THAT:

SECTION 1. The City Council hereby approves and adopts the Planning and Design Drainage Criteria ("Criteria") attached as Exhibit "A." The City commits to the implementation of the requirements and guidelines set forth in the adopted Criteria. A copy of the Criteria will be maintained on file in the office of the City Secretary.

SECTION 2. If any section, paragraph, subdivision, clause, phrase or provision of this ordinance shall be judged invalid or unconstitutional, the same shall not affect the validity of this ordinance as a whole or any portion thereof other than that portion so decided to be invalid or unconstitutional.

SECTION 3. That all provisions of the Ordinances of the City of Lucas in conflict with the provisions of this Ordinance be, and the same are hereby repealed and all other provisions of the Ordinances of the City of Lucas not in conflict with the provisions of this Ordinance shall remain in full force and effect.

SECTION 4. That an offense committed before the effective date of this ordinance is governed by the prior law and the provisions of the Code of Ordinances, as amended, in effect when the offense was committed and the former law is continued in effect for this purpose.

SECTION 5. Any person, firm or corporation violating any of the provisions or terms of this Ordinance shall be subject to the same penalty as provided for in the Code of Ordinances, as

amended, and upon conviction in the municipal court shall be punished by a fine not to exceed the sum of Two Thousand Dollars (\$2,000) for each offense, and each and every day such violation shall continue shall be deemed to constitute a separate offense.

SECTION 6. This ordinance shall take effect immediately from and after its passage as the law in such case provides.

DULY PASSED BY THE CITY COUNCIL OF THE CITY OF LUCAS, COLLIN COUNTY, TEXAS ON THIS THE 2nd DAY OF APRIL, 2009.

DULY PASSED BY THE CITY COUNCIL OF THE CITY OF LUCAS, COLLIN

APPROVED:

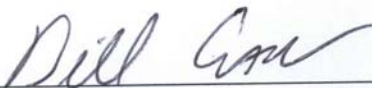

Bill Carmickle, Mayor

ATTEST:

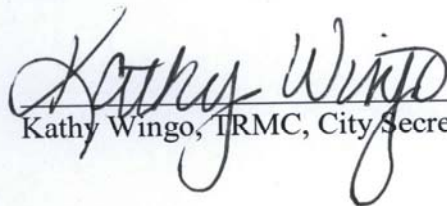

Kathy Wingo, IRMC, City Secretary



APPROVED AS TO FORM:

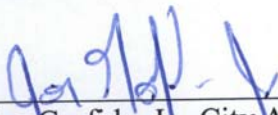

Joe Gorfida, Jr., City Attorney
(JJG/ego/35057)

WATER RUN-OFF MANUAL

PLANNING AND DESIGN DRAINAGE CRITERIA

A. General

The Drainage Criteria included in this section are for the purpose of providing a set of guidelines for planning and designing storm drainage facilities in the City of Lucas, Texas and within its extraterritorial jurisdiction. These criteria will be used by the Department of Public Works, other City Departments, consulting engineers employed by the City, and engineers for private developments in the City.

B. Rational Method for Peak Storm Flows

The formula to be used for calculating peak storm flows for drainage areas less than 200 acres shall be the Rational Method, in which:

$Q = CIA$, where

Q - is the peak storm flow at a given point in cubic feet per second (cfs)

C - is the runoff coefficient that is equal to the ratio that the peak rate of runoff bears to the average rate (intensity) of rainfall;

I - is the average intensity of rainfall in inches per hour for a storm duration equal to the time of travel for run off to flow from the farthest point of the drainage area to the design point in question;

A - is the drainage area tributary to the design point, in acres.

Note: For drainage areas greater than 200 acres, peak storm flows shall be determined based on a flow routing analysis using detailed hydrographs such as the Soil Conservation Service hydrologic methods that are available in such computer programs as TR-20, HEC-1, etc.

C. Runoff Coefficient

The runoff coefficient (C) shall consider the slope of the terrain, the character of the land use, the length of overland flow and the imperviousness of the drainage area and shall be determined based on ultimate land development. The run-off coefficient for the appropriate land used shall be as follows:

Commercial 0.90

Industrial 0.70

Single Family Residential 0.55

Multi-Family 0.75

Parks and Open Space 0.35

Schools, Churches, etc. 0.75

D. Rainfall Intensity-Frequency

The rainfall intensity-frequency curves should be plotted from data from TXDOT or other government sources in our area. The intensity (I) in the formula $Q = CIA$, is determined from the curves by arriving at a time of concentration for the subject drainage area and adapting a storm frequency upon which to base the design of drainage improvements.

1. Time of Concentration The time of concentration, which is the longest time of travel for runoff to flow from any point of the subject drainage area to the design point, consists of the time required for runoff to flow overland plus the time required to flow in a street gutter, storm drain, open channel or other conveyance facility. A minimum time of concentration of fifteen (15) minutes shall be used for Single Family Residential, Parks and Open Space areas and a minimum time of concentration of ten (10) minutes shall be used for Commercial, Industrial, Multi-Family Residential, School and Church areas. A nomograph, is attached for estimating the time of concentration.

2. Storm Frequency

Required design storm frequencies for storm drainage improvements in the City of Lucas are shown in the following table.

Type of Design Frequency
Facility (years)

*Storm Sewer Systems 25

*Culverts, Bridges, 100

* The drainage system shall be designed to carry those flows greater than the 25-year frequency up to and including a 100-year frequency within defined rights-of-way or drainage easements.

E. Area

The drainage area used in determining peak storm flows shall be calculated by subdividing a map into the watersheds within the basin contributing storm water runoff to the system. Areas shall be determined by planimetry or digitizing.

F. Spread of Water

During the design storm, the quantity of storm water that is allowed to collect in the streets before being intercepted by a storm drainage system is referred to as the "spread of water". In determining the limitations for carrying storm water in the street, the ultimate development of the street shall be considered. The use of the street for carrying storm water shall be limited to the following:

SPREAD OF WATER

Major thoroughfares (divided) - One traffic lane on each side to remain clear.

Thoroughfares (not divided) - Two traffic lanes to remain clear.

Collector streets - One traffic lane to remain clear.

Residential streets - Six-inch depth of flow at curb and One traffic lane to remain clear.

G. Storm Sewer Design

Storm water in excess of that allowed to collect in the streets shall be intercepted in inlets and conveyed in a storm sewer system. Storm sewer capacity shall be calculated by the Mannings-formula --

$$Q = AV, \text{ and}$$

$$Q = 1.486 AR^{2/3} S^{1/2} / n$$

where

Q is the discharge in cubic feet per second;

A is the cross-sectional area of the conduit in square feet;

V is the velocity of flow in the conduit in feet per second;

R is the hydraulic radius in feet, which is the area of flow divided by the wetted Perimeter.

S is the slope of the hydraulic gradient in feet per foot;

n is the coefficient of roughness.

The recommended roughness coefficients to use in the design of a storm sewer system are as follows:

Type of Storm Drain Manning's Coefficient

Concrete Box Culvert 0.015

New Concrete Pipe 0.013

Standard, unpaved, with or without
bituminous coating corrugated
metal pipe 0.024

Paved invert, 25% of periphery paved
corrugated metal pipe 0.021

Paved invert, 50% of periphery paved
corrugated metal pipe 0.018

100% paved and bituminous coated
corrugated metal pipe 0.013

In the design of the storm sewer system, the elevation of the hydraulic gradient of the storm sewer shall be a minimum of 0.5 feet below the elevation of the adjacent street gutter. Storm sewer pipe sizes shall be so selected that the average velocity in the pipe will not exceed 15 feet per second nor less than 3 feet per second. The minimum grade recommended for storm sewer pipe is 0.30%. Closed storm sewer systems shall be installed in all areas where the quantity of storm runoff is 300 cubic feet per second, or less at the discretion of the city. A closed storm sewer system may be constructed when the quantity exceeds 300 cfs, at the discretion of the City. Hydraulic gradients shall be calculated and lines drawn for each storm sewer.

H. Intentionally left blank for future use

I. Open Channel Design

Storm water runoff in excess of that allowed to collect and be conveyed in the streets in developed areas and runoff in undeveloped areas may be carried in grass lined, concrete lined or weathered rock open channels. Earthen, non-vegetated or unlined open channels are not acceptable. Open channel capacity shall be calculated by the Manning's Formula, and roughness coefficients shall be as follows:

Maximum Permissible

Type of Lining Roughness Coefficient "n" Mean Velocity

Earth (Bermuda grass) 0.035 6 ft. per sec.

Concrete Lined 0.015 15 ft. per sec.

Weathered Rock 0.030 10 ft. per sec.

Open channels shall be constructed with a trapezoidal cross-section and shall have side slopes no steeper than 3:1 when grass lined and 1.5:1 when lined with concrete. A right-of-way for all channels of sufficient width shall be dedicated to provide for excavation of the open channel of proper width, plus ten feet on each side to permit ingress and egress for maintenance. Additional width may be considered if sanitary sewer mains are proposed to follow the channel alignment.

J. Culvert Design

At locations of stream or open channel crossings with proposed roadway improvements, it is sometimes necessary to receive and transport storm water under the roadway in culverts. The quantity of flow shall be determined by the appropriate method, and the friction loss through of the culvert shall be calculated by Manning's Formula.

Design of culverts shall include the determination of upstream backwater conditions as well as downstream velocities and flooding conditions. Consideration shall be given to the discharge velocity from culverts, and the limitations specified culverts shall not be less than 18". A headwall is required at exposed ends. Under private drives concrete or steel culverts, under public road concrete culverts are required.

K. Stormwater Detention Pond Design

The basic concept underlying the use of stormwater detention ponds (SDP) involves providing temporary storage of stormwater runoff so that peak rates of runoff can be reduced. Runoff is released from storage at a controlled rate which cannot exceed the capacities of the existing downstream drainage systems or the pre developed peak runoff rate of the site, whichever is less. Stormwater detention ponds may be of two (2) basic types: On-site and Regional. In general, on-site ponds are those which are located off-channel and provide stormwater detention for a particular project of development. Regional ponds are designed to provide stormwater detention in conjunction with other improvements on a watershed-wide basis. The performance and safety criteria in this section apply to all ponds which provide management of peak rates of stormwater runoff, regardless of type.

PERFORMANCE CRITERIA FOR ON-SITE SDP's

1. On-site SDP's are further classified as either small or large, as follows:

ON-SITE SDP

POND CLASS DRAINAGE AREA

Small <25 acres

Large 25-64 acres

For design purposes, any pond with a drainage area larger than 64 acres shall be classified as a regional pond.

2. On-site SDP ponds shall be designed to reduce post-development peak rate of discharge to existing pre-development peak rates of discharge for the 2-, 10-, 25- and 100-year storm events at each point of discharge from the project or development site. In addition, the capacity of the existing downstream systems must be considered in determining the need for managing the 100-year storm event. For the post-development hydrologic analysis, any offsite areas which drain to the pond shall be assumed to remain in the existing developed condition.
3. The Rational Method (RM) may be used for the design of small on-site ponds only. The maximum contributing drainage area to a pond designed with the RM is 50 acres when using this equation.
4. A design method approved by the City Engineer.

PERFORMANCE CRITERIA FOR REGIONAL SDP's

1. Regional SDP's are classified as small or large, based on the following criteria:

REGIONAL IMPOUNDED

POND CLASS VOLUME, AC-FT

Small 0-150

Large >150

Any regional pond with a height of dam over 15 feet shall be classified as a large regional pond.

2. Performance criteria for regional detention ponds shall be determined by the City on a project-by-project basis. The determination shall be based on a preliminary engineering study prepared by the project engineer.

SAFETY CRITERIA FOR SDP's

All ponds shall meet or exceed all specified safety criteria. Use of these criteria shall in no way relieve the engineer of the responsibility for the adequacy and safety of all aspects of the design of the SDP.

1. The spillway, embankment, and appurtenant structures shall be designed to safely pass the design storm hydrograph with the freeboard shown in the table below. All contributing drainage areas, including on-site and off-site area, shall be assumed to be fully developed. Any

orifice with a dimension smaller than or equal to twelve (12) inches shall be assumed to be fully blocked.

**DETENTION DESIGN STORM FREEBOARD TO TOP
POND CLASS EVENT OF EMBANKMENT, FT.**

On-site: Small 100 year 0

Large 100 year 1.0

Regional: Small 100 Year 2.0

Large 100 year *

*Design storm event and required freeboard for large regional ponds shall be determined in accordance with Chapter 299 of the Texas Administrative Code (Dam Safety Rules of the Texas Natural Resource Conservation Commission).

2. All SDP's (except small on-site ponds) shall be designed using a hydrograph routing methodology. The Rational Method (RM) may be used only for contributing drainage areas less than fifty (50) acres.

3. The minimum embankment top width of earthen embankments shall be as follows:

TOTAL HEIGHT OF MINIMUM TOP EMBANKMENT, FT. WIDTH, FT.

0-6, 4'

6-10, 6'

10-15, 8'

15-20, 10'

20-25, 12'

25-35, 15'

4. The constructed height of an earthen embankment shall be equal to the design height plus the amount necessary to ensure that the design height will be maintained once all settlement has taken place. This amount shall in no case be less than five (5%) percent of the total fill height. All earthen embankments shall be compacted to 95% of maximum density.

5. Earthen embankment side slopes shall be no steeper than three (3) horizontal to one (1) vertical. Slopes must be designed to resist erosion, to be stable in all conditions and to be easily maintained. Earthen side slopes for regional facilities shall be designed on the basis of appropriate geotechnical analyses.

6. Detailed hydraulic design calculation shall be provided for all SDP's. Stage-discharge rating data shall be presented in tabular form with all discharge components, such as orifice, weir, and outlet conduit flows, clearly indicated. A stage-storage table shall also be provided.

7. When designing SPD's in a series (i.e., when the discharge of one pond becomes the inflow to another), the engineer must submit a hydrologic analysis which demonstrates the system's adequacy. This analysis must incorporate the development of hydrographs for all inflow and outflow components.

8. No outlet structures from SDP's, parking detention, or other concentrating structures shall be designed to discharge concentrated flow directly onto arterial or collector streets. Such discharges shall be conveyed by a closed conduit to the nearest existing storm sewer. If there is no existing storm sewer within 300 feet, the outlet design shall provide for a change in the discharge pattern from concentrated flow back to sheet flow, following as near as possible the direction of the gutter.

9. Stormwater runoff may be detained within parking lots. However, the engineer should be aware of the inconvenience to both pedestrians and traffic. The location of ponding areas in a parking lot should be planned so that this condition is minimized. Stormwater ponding depths (for the 100-year storm) in parking lots are limited to an average of eight (8") inches with a maximum of twelve (12") inches.

10. All pipes discharging into a public storm sewer system shall have a minimum diameter of twelve (12"). In all cases, ease of maintenance and/or repair must be assured.

11. All concentrated flows into a SDP shall be collected and conveyed into the pond in such a way as to prevent erosion of the side slopes. All outfalls into the pond shall be designed to be stable and non-erosive.

OUTLET STRUCTURE DESIGN

There are two (2) basic types of outlet control structures: those incorporating orifice flow and those incorporating weir flow. Weir flow is additionally broken down into two (2) categories: rectangular and V-notch. In each type, the bottom edge of the weir over which the water flows is called the crest. Sharp-crested and broad-crested weirs are the most common types. Generally, if the crest thickness is more than 60% of the nappe thickness, the weir should be considered broad-crested. The coefficients for sharp-crested and broad-crested weirs vary. The respective weir and orifice flow equations are as follows:

1. Rectangular Weir Flow Equation

$$Q = CLH^{3/2}$$

where

Q = Weir discharge, cubic feet per second

C = Weir coefficient

L = Horizontal length, feet

H = Head on weir, feet

2. V-notch Weir Flow Equation \\

$$Q = C_v \tan(O/2) H^{2.5}$$

where

Q = Weir Flow, cubic feet per second

C_v = Weir Coefficient

O = Angle of the Weir notch at the apex (degrees)

H = Head on Weir, feet

3. Orifice Flow Equation

$$Q = C_o A (2gH)^{0.5}$$

Where

Q = Orifice Flow, cubic feet per second

C_o = Orifice Coefficient (use 0.6)

A = Orifice Area, square feet

g = Gravitation constant, 32.2 feet/sec²

H = Head on orifice measured from centerline, feet

Analytical methods and equations for other types of structures shall be approved by the City prior to use.

DETENTION POND STORAGE DETERMINATION

The method to be used for determining detention pond volume requirements is governed initially by the size of the total contributing drainage area to the pond.

For contributing areas up to fifty (50) acres, the Rational Method (RM) may be used.

For contributing areas greater than fifty (50) acres, a flow routing analysis using detailed hydrographs must be applied. The Soil Conservation Service hydrologic methods (available in TR-20, HEC-1) can be used. The engineer may use other methods but must have their acceptability approved by the City engineer. These methods may also be used for the smaller areas.

DETENTION POND MAINTENANCE AND EQUIPMENT ACCESS REQUIREMENTS

1. Silt shall be removed and the pond returned to original lines and grades when standing water conditions occur or the pond storage volume is reduced by more than 10%.
2. To limit erosion, no unvegetated area shall exceed 10 sq. ft in extent.
3. Accumulated paper, trash and debris shall be removed every 4 weeks or as necessary to maintain proper operation.
4. Ponds shall be mowed monthly between the months of May and September.
5. Corrective maintenance is required any time a pond does not drain completely within 60 hours of cessation of inflow (i.e., no standing water is allowed).
6. Structural integrity of pond embankments shall be maintained at all times.
7. Upon completion of development the owners/Homeowners association shall be required to maintain the detention basin in its original designed and approved condition.

- | | |
|-------------------------------------|--------------------|
| <input type="checkbox"/> | Annexation |
| <input type="checkbox"/> | Disannexation |
| <input checked="" type="checkbox"/> | Code of Ordinances |
| <input type="checkbox"/> | Other |

ORDINANCE # 2009-04-00645
[STORMWATER RUN-OFF REGULATIONS]

AN ORDINANCE OF THE CITY OF LUCAS, TEXAS AMENDING THE CODE OF ORDINANCES OF THE CITY OF LUCAS BY AMENDING CHAPTER 10, "SUBDIVISIONS" BY ADDING A NEW ARTICLE 10.04 TITLED "STORMWATER RUNOFF REGULATIONS AND CONTROL"; PROVIDING A REPEALING CLAUSE; PROVIDING A SAVINGS CLAUSE; PROVIDING A SEVERABILITY CLAUSE; PROVIDING A PENALTY CLAUSE AND PROVIDING AN EFFECTIVE DATE.

WHEREAS, the after discussing and consideration, the City Council of the City of Lucas, Texas, finds that it is in the best interest of the City and its citizens to amend Chapter 10, "Subdivisions" by adding Article 10.04 "Stormwater Runoff Regulations."

NOW, THEREFORE, BE IT ORDAINED BY THE CITY COUNCIL OF THE CITY OF LUCAS, TEXAS:

SECTION 1. That Chapter 10 "Subdivision" of the City of Lucas Code of Ordinances be, and the same is hereby amended by adding a new Article 10.04 titled "Stormwater Runoff Regulations and Control" to read as follows:

"ARTICLE 10.04 STORMWATER RUNOFF REGULATIONS AND CONTROL

Sec. 10.04.001 Purpose

The purpose of this Article is to diminish threats to the public health and safety caused by the runoff of excess stormwater, to minimize movement of soils resulting from development, to reduce the possibilities of hydraulic overloading of the storm sewer drainage system, to reduce economic losses to individuals and the community at large as a result of erosion and the runoff of excess stormwater, and to protect and conserve land and water resources, while at the same time ensuring orderly development. The provisions of this Article are specifically intended to supplement existing ordinances regulating the following:

- (1) The subdivision, layout, and improvement of lands located within the City of Lucas;
- (2) The excavating, filling, and grading of lots and other parcels or areas;

- (3) The construction of buildings, including related parking and other paved areas, and the drainage of the sites on which those structures and their related parking and other paved areas are located; and
- (4) The design, construction, and maintenance of erosion control and stormwater drainage facilities and systems.

Sec. 10.04.002 Definitions

For the purposes of this Article, the following definitions are adopted:

Base flood elevation. The elevation delineating the flood level having a one-percent probability of being equaled or exceeded in any given year (also known as the 100-year flood elevation), as determined from Flood Insurance Rate Maps (FIRMS) or the best available information.

Channel. A natural or man-made open watercourse with definite bed and banks which periodically or continuously contains moving water, or which forms a connecting link between two bodies of water.

City. The City of Lucas.

City engineer. The City Engineer or his designee.

City manager. The City Manager or his designee.

Conduit. Any channel, pipe, sewer, or culvert used for the conveyance of movement of water, whether open or closed.

Control elevation. Contour lines and points of predetermined elevation used to denote a detention storage area on a plat or site drawing.

Design standards for public improvements. Standards on file in the city's offices to which all designs and the resulting public improvements, must conform.

Detention facility. A facility constructed or modified to restrict the flow of stormwater to a prescribed maximum rate, and to concurrently detain the excess waters that accumulated behind the outlet.

Detention storage. The temporary detaining or storage of stormwater in storage basins, on rooftops, in streets, parking lots, school yards, parks, open space, or other areas under predetermined and controlled conditions, with the rate of drainage there from regulated by appropriately installed devices.

Discharge. The rate of outflow of water from any source.

Drainage area. The area from which water is carried off by a drainage system, i.e., a watershed or catchment area.

Excess stormwater runoff. The rate of flow of stormwater discharged from an urbanized drainage area which is or will be in excess of that volume and rate which represented or represents the runoff from the property prior to the date of this Article.

Floodplain. The special flood hazard lands adjoining a watercourse, the surface elevation of which is lower than the Base Flood Elevation and is subject to periodic inundation.

Hydrograph. A graph showing, for a given point on a stream or conduit, the runoff flow rate with respect to time.

Land disturbance. Any man-made change to improve or unimprove real estate including but not limited to building structures, filling, grading, excavation, clearing, or removal of vegetation.

One-hundred year storm. A precipitation event of 24-hours' duration, having a one percent chance of occurring in any one year.

Peak flow. The maximum rate of flow of stormwater at a given point or in a channel or conduit resulting from a predetermined storm or flood.

Sediment. Any particulate matter that can be transported by fluid flow, and which eventually is deposited.

Stormwater drainage system. All means, natural or manmade, used for conducting stormwater to, through, or from a drainage area to the point of final outlet including, but not limited to, any of the following: open and closed conduits and appurtenant features, canals, channels, ditches, streams, swales, culverts, streets, and pumping stations.

Stormwater drainage facility. Any element in a stormwater drainage system which is made or improved by man.

Stormwater runoff. The waters derived from precipitation within a tributary drainage area flowing over the surface of the ground or collected in channels or conduits.

Time of concentration. The elapsed time for stormwater to flow from the most distant point in a drainage area to the outlet or other predetermined point.

Two-year storm. A precipitation event having a fifty percent chance of occurring in any one year.

Two-year storm runoff. The stormwater runoff having a fifty percent probability of occurring in any one year.

Unprotected channel. A channel which receives stormwater discharge and which is not paved, rip-rapped, or otherwise improved by addition of man-made materials so as to reduce the potential for erosion.

Upland area. Any land whose surface drainage flows toward the area being considered for development.

Urbanization. The development, change, or improvement of any parcel of land consisting of one or more lots for residential, commercial, industrial, institutional, recreational, or public utility purposes.

Waterbody. Any natural or artificial pond, lake, reservoir, or other area which ordinarily or intermittently contains water and which has a discernable shoreline.

Watercourse. Any natural or artificial stream, river, creek, channel, ditch, canal, conduit, culvert, drain, waterway, gully, ravine, street, roadway, swale, or wash in which water flows in a definite direction, either continuously or intermittently, and which has a definite channel, bed, or banks.

Wet bottom detention basin. A basin designed to retain a permanent pool of stormwater after having provided its planned detention of runoff during a storm event.

Sec. 10.04.003 Permit

Before initiating any activity regulated by this Article, an applicant shall be required to obtain a permit from the city which indicated that the requirements of this Article have been met. Permit fees shall be located in the city fee schedule for permits.

Sec. 10.04.004 Other requirements

In addition to meeting the requirements of 10.04.003 and the more specific requirements of 10.04.005 – 10.04.029 of this Article and before starting any activity regulated by this Article, an applicant shall comply with the requirements set forth in all other related ordinances and state statutes and regulations.

Sec. 10.04.005 Specific requirements; general

Sediment shall be maintained on site and excess stormwater runoff shall be detained in connection with any new construction, development, redevelopment, or land use change occurring within the city in accordance with the requirements set forth in this Article. Notwithstanding the foregoing, exceptions to this requirement are as follows:

- (1) For stormwater detention, the development of any subdivision of five or less single-family lots.

- (2) For stormwater detention, the development of commercial or industrial property in which the increase in run-off is less than ten percent (10%) of the pre-development runoff rate and less than five (5) cubic feet per second.
- (3) A determination by the city that the excess runoff from the proposed construction, development, redevelopment, or land use change will be insufficient to adversely effect the carrying capacity of the receiving body or watercourse. In this connection and should the city's determination of insufficient adverse effect be sought, the developer shall make available to the city such hydraulic or hydrologic computations as will support the requested exception.
- (4) In the event it is determined to the city manager's satisfaction, after consultation with appropriate engineering consultants, that the goals of this Article will be better met by the owner or developer of the site paying to the city an amount equal to the cost of the detention pond(s) required herein. Such cost shall be determined by the actual construction cost amount, if known, or as estimated by the design engineer and approved by the city. This agreement and payment will be completed before the city's approval of the development's construction plans.

Sec. 10.04.006 Discharge rate

The peak discharge rate after full development resulting from the proposed development shall not exceed the corresponding peak discharge rate prior to development during storms of 2-year, 5-year, 10-year, and 25 year return frequencies.

Sec. 10.04.007 Flood elevation

There shall be no detrimental effect on the floodway or the flood elevation during a 100 year storm upstream or downstream of the proposed development area as a result of the proposed development.

Sec. 10.04.008 Allowable detention facilities

The increased stormwater runoff resulting from proposed development shall be detained by providing for appropriate detention storage as required by this Article. Where streets or parking areas are used for temporary storage of stormwater runoff all manholes for sanitary sewers shall be of a type which prevent the infiltration of the ponded water. Where streets are used for the temporary storage of stormwater runoff, in no case shall the maximum design depth exceed six (6) inches.

Sec. 10.04.009 Detention storage

Designs for detention storage and related appurtenances shall be submitted to the city for approval. Upon submittal of designs of detention storage the city shall make a determination as to whether any or all of the facilities proposed are to become part of the public drainage system. The city shall, at the same time, in the case of a proposed subdivision make a determination as to

those control elevations that shall be entered on the final plat or make a determination as to the necessity for deed restrictions on any particular lot in said subdivision requiring the preservation of mandatory drainage facilities. Where a non-subdivided parcel of land is proposed for development, the city shall make a determination as to the need for covenants to maintain responsibility for mandatory drainage facilities. All of said facilities shall be designed and constructed in accordance with the city specifications, and shall be subject to continuing inspection during the construction period in the same manner as any other improvement regulated under this Article. Detention facilities associated with residential subdivisions shall be in a separate lot that shall be deeded to the HOA after 75% of the lots in the subdivision are occupied and the lot soil stabilized. Prior to acceptance of the detention facility the city and the developer will inspect the facility to assure it meets all of the requirements of this Article. If any deficiencies are found, the developer will be responsible to make the necessary changes at his expense. Wet bottom detention basin, shall be aerated or designed to drain within 60 hours.

Sec. 10.04.010 Sizing of detention storage and outlet

Detention storage shall meet the requirements of this Article and the City of Lucas drainage manual.

Sec. 10.04.011 Discharge velocity

The discharge velocity from detention facilities shall not exceed three feet per second unless it is determined by the city that greater velocities will not be harmful to the receiving channel. Where the city's determination is requested, the developer shall make available such hydraulic or hydrologic computations as will adequately support the course of action being requested.

Sec. 10.04.012 Emergency spillway

Emergency spillways shall be provided to permit the safe passage of runoff generated from rainfall events in excess of the 100-year rainfall event.

Sec. 10.04.013 Freeboard

Detention storage areas shall have adequate capacity to contain the storage volume of tributary stormwater runoff with at least one foot of freeboard above the water surface during the 100-year rainfall event.

Sec. 10.04.014 Joint development of control system

Stormwater control systems may be planned in coordination by two or more property owners as long as the potential for damage from stormwater is not increased at intervening locations.

Sec. 10.04.015 Early installation of control systems

Stormwater control measures shall be installed prior to undertaking other grading of site and a schedule of construction for this purpose shall be submitted by the owner(s)/developer(s) prior to construction in the city.

Sec. 10.04.016 Flows from upland areas

The total drainage area must be used in calculating the allowable release rate. The required storage volume will be based on the project area only, with extraneous flows from upland areas being bypassed or discharged via overflow spillways or other devices. Where storm sewers are required they shall be of such size as will provide sufficient capacity to receive the flow generated by five-year storm from upland areas. As to the latter and regardless of whether it has occurred in fact, such upland area shall be deemed to have been fully developed for all purposes of this requirement.

Sec. 10.04.017 Land disturbance of five acres or more

The developer shall comply with the State of Texas Commission on Environmental Quality or TPDES and federal NPDES permit for Storm water Discharges Associated with Construction Activity and provide a copy to the city prior to starting construction.

Sec. 10.04.018 Land disturbance of more than two acres and less than five acres

The developer shall submit to the city a sediment and erosion control plan that meets the requirements of the State of Texas Commission on environmental quality or cpdes and federal NPDES Permit for Storm water Discharges Associated with construction Activity prior to starting construction.

Sec. 10.04.019 All land disturbances

Land disturbances associated with any new construction, development, redevelopment, or land use change on any site of 2,500 square foot or larger or requiring a building permit shall incorporate into the development plan the following elements as minimum:

- (1) Stone construction entrance.
- (2) Silt fence or other sediment retaining device on the low side of the site.
- (3) Temporary seeding of disturbed areas remaining open more than three weeks.
- (4) Immediate removal of soil tracked into the public right-of-way.
- (5) Permanent turf established. A copy of the development plan shall be submitted to the city prior to starting construction.

Sec. 10.04.020 Preliminary plats

Information indicating the manner in which the provisions of this Article are to be met shall be submitted with the preliminary plats.

Sec. 10.04.021 Requirements for construction plans

Information indicating the manner in which the provisions of this Article are to be met shall be submitted with all construction plan submissions or any other plan for improvements which falls under the requirements of 10.04.005 of this Article. All computations, plans, and specifications shall be prepared and sealed by a professional engineer registered in the State of Texas.

Sec. 10.04.022 Requirements for final plats

The easements or separate lots required for detention facilities shall be shown on the final plat. The control elevation for each detention facility shall be shown on the plat near the detention facility.

Sec. 10.04.023 Drainage and detention design requirements

All subdivisions and other proposed improvements which are subject to the provisions of 10.04.005 of this Article shall incorporate such design features as are required in this Article. Variation from these requirements shall require the approval of the city planning commission whose action shall be conditioned upon the following:

- (1) That a petition be submitted describing in detail the rationale for the proposed design change.
- (2) That there are special circumstances or conditions affecting the property under consideration such that strict compliance with the provisions of this Article would deprive the applicant of the reasonable use of his land.
- (3) That the variance is necessary for the preservation and enjoyment of a substantial property right of the proprietor.
- (4) That the granting of the variance will not be detrimental to the public health, safety, or welfare or injurious to other property in the territory in which said property is located.

Sec. 10.04.024 Maintenance

Designs of detention facilities will incorporate features which facilitate their inspection and maintenance. The designer shall submit an operation and maintenance (O&M) plan for any detention facility prior to its approval by the city. All privately owned detention facilities may be inspected by representatives of the city at such times as they deem necessary. If deficiencies, or conditions creating nuisances, are found, the owner or Home owners association shall be required to initiate the necessary corrections within fourteen (14) days, and all deficiencies shall corrected within forty-five (45) days.

Sec. 10.04.025 Safety features

Designs of detention facilities shall incorporate safety features, particularly at inlets, outlets, on steep slopes, and at any attractive nuisances. These features shall include, but not be limited to, fencing, hand rails, lighting, steps, grills, signs, and other protective or warning devices so as to restrict access.

Sec. 10.04.026 Responsibility

The administration of this Article shall be the responsibility of the city.

Sec. 10.04.027 Interpretation

In the interpretation and application of this Article, the provisions expressed herein shall be held to be the minimum requirements and shall be liberally construed in favor of the City of Lucas.

Sec. 10.04.028 Appeals

The City of Lucas City council is hereby designated as the appeals board for disputes arising from the application of this Article. The council's responsibility shall be to hear appeals where it is alleged by an appellant that there is error in any order, requirement, decision, grant or refusal made by the city in the enforcement of the provisions of this Article.

Sec. 10.04.029 Penalties

- (1) General. Any person, firm, organization, association, or corporation violating any of the provisions of this Article , including violation of any variances granted under the authority of this Article , shall be deemed guilty of a violation of a municipal ordinance and each such person or other entity shall be deemed guilty of a separate offense for each and every day or portion thereof that any violation of any of the provisions of this code is committed, continued or permitted, and upon conviction of such violation, such person or other entity may be punished by a fine of not less than two hundred and fifty dollars (\$250.00) and not more than two thousand dollars (\$2,000.00).
- (2) Additional corrective actions. Any building or structure constructed in violation of the provisions of this Article or any use carried on in violation of this Article is hereby declared to be a nuisance per se, with any court of competent jurisdiction having the authority to determine that the owner or developer is guilty of maintaining a nuisance per se and to order such nuisance abated. In this connection, the city is hereby authorized to institute any appropriate action or proceeding in any appropriate court to prevent, restrain, correct, or abate any violations of this Article."

SECTION 2. That all provisions of the ordinances of the City of Lucas, Texas, in conflict with the provisions of this ordinance be, and the same are hereby, repealed, and all other provisions of the ordinances of the City not in conflict with the provisions of this ordinance shall remain in full force and effect.

SECTION 3. That an offense committed before the effective date of this ordinance is governed by the prior law and the provisions of the Code of Ordinances, as amended, in effect when the offense was committed and the former law is continued in effect for this purpose.

SECTION 4. That should any sentence, paragraph, subdivision, clause, phrase or section of this ordinance be adjudged or held to be unconstitutional, illegal or invalid, the same shall not affect the validity of this ordinance as a whole, or any part or provision thereof other than the part so decided to be invalid, illegal or unconstitutional, and shall not affect the validity of the Code of Ordinances as a whole.

SECTION 5. Any person, firm or corporation violating any of the provisions or terms of this Ordinance shall be subject to the same penalty as provided for in the Code of Ordinances, as amended, and upon conviction in the municipal court shall be punished by a fine not to exceed the sum of Two Thousand Dollars (\$2,000) for each offense, and each and every day such violation shall continue shall be deemed to constitute a separate offense.

SECTION 6. This ordinance shall take effect immediately from and after its passage and the publication of the caption, as the law in such cases provides.

PASSED AND APPROVED by the City Council of the City of Lucas, Texas, on the 2nd
day of April, 2009.

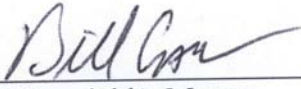

Bill Carmickle, Mayor

ATTEST:



Kathy Wingo, TRMC, City Secretary



APPROVED AS TO FORM:



JOSEPH J. GORFIDA, JR., CITY ATTORNEY
(JJG/cgo/33783)



City of Lucas Planning & Zoning Agenda Request June 10, 2021

Item No. 03

Requester: City Secretary Stacy Henderson

Agenda Item Request

Consider approval of the minutes of the May 13, 2021 Planning and Zoning Commission meeting.

Background Information

NA

Attachments/Supporting Documentation

1. May 13, 2021 Planning and Zoning Commission minutes.

Budget/Financial Impact

NA

Recommendation

NA

Motion

I make a motion to approve the minutes of the May 13, 2021 Planning and Zoning Commission meeting.



City of Lucas
Planning and Zoning Commission

Regular Meeting
City Hall Council Chambers
and Video Conference Only

May 13, 2021
7:00 PM

City Hall – 665 Country Club Road – Lucas, Texas

MINUTES

Call to Order

Vice Chairman Rusterholtz called the meeting to order at 7:00 pm. It was determined that a quorum was present, and the Pledge of Allegiance was recited.

Vice Chairman Rusterholtz announced that Alternate Member James Foster would be serving as a voting member.

Commissioners Present:

Vice Chairman Peggy Rusterholtz
Commissioner Joe Williams
Commissioner Tommy Tolson
Commissioner Dusty Kuykendall
Alternate Commissioner Adam Sussman (*left meeting at 8:03 pm*)
Alternate Commissioner James Foster

Staff Present:

City Manager Joni Clarke
Development Services Director Joe Hilbourn
City Secretary Stacy Henderson
City Attorney Courtney Morris

City Council:

Mayor Jim Olk, Liaison
City Councilmember David Keer

Public Hearing Agenda

1. **Public hearing to consider the request by Tractor Supply for a Specific Use Permit to allow outside storage on a 5.56-acre section of a tract of land in the William Snider Survey, Abstract Number 821, Tract 16 situated in the City of Lucas, Collin County, Texas, located at 495 South Angel Parkway.**

Development Services Director Joe Hilbourn gave a presentation regarding the specific use permit request.

The applicant, Drew Donosky with Clay Moore Engineering, discussed with the Commission the garden center, proposed outside storage, where equipment would be kept, times of deliveries to the store, proposed screening from the residential area, and store hours from 8 am to 9 pm.

Vice Chairman Rusterholtz opened the public hearing 7:08 pm, there being no one wishing to speak, the public hearing was closed at 7:09 pm.

MOTION: A motion was made by Vice Chairman Rusterholtz, seconded by Commissioner Kuykendall to approve the specific use permit for Tractor Supply to allow outside storage on a 5.56-acre section of a tract of land located at 495 South Angel Parkway with the following conditions. The motion passed unanimously by a 5 to 0 vote.

- The outside storage be contained to the two areas shown on the site plan
- The screening wall, trees, and plants provided on the east property line be perpetually maintained to screen the residential area from the commercial business.
- The site plan, landscape plan and elevations be tied to the specific use permit

Regular Agenda

2. Consider approval of an application for a site plan, landscape plan, and elevations submitted by the property owner Bill Shipley on behalf of Tractor Supply for use as a commercial farm and garden retail center on a 5.56-acre tract of land in the William Snider Survey, Abstract Number 821, situated in the City of Lucas, Collin County, Texas, located at 573 Angel Parkway.

This item could not be acted upon due to an incorrect address posted on the agenda.

MOTION: A motion was made by Commissioner Williams, seconded by Commissioner Tolson to deny the application for site plan, landscape plan and elevations due to an incorrect address posted and that the item be brought back with the correct address and final plat added to the request. The motion passed unanimously by a 5 to 0 vote.

City Attorney Courtney Morris informed the Commission that the wording of the motion needed to include specific wording related to denial without prejudice.

MOTION: A motion was made by Commissioner Tolson, seconded by Commissioner Williams to reconsider and rescind the previous motion. The motion to rescind the previous motion passed unanimously by a 5 to 0 vote.

MOTION: A motion was made by Vice Chairman Rusterholtz, seconded by Commissioner Williams to deny the request without prejudice for the site plan, landscape plan, and elevations submitted by the property owner Bill Shipley on behalf of Tractor Supply for use as a commercial farm and garden retail center due to the property being addressed incorrectly as 573 Angel Parkway and the final plat was not included in the public notice. The motion to deny without prejudice passed unanimously by a 5 to 0 vote.

- 3. Consider the request by Tom Goodwin on behalf of Trinity Tabernacle for a final plat located in the Ben Sparks Survey, ABS A0813, tract 17, being a 7.278-acre tract of land, located at 1130 West Lucas Road, Lucas, Texas 75002.**

Commissioner Williams recused himself from this agenda item due to a conflict of interest.

MOTION: A motion was made by Commissioner Kuykendall, seconded by Alternate Commissioner Foster to approve the final plat of Trinity Tabernacle located in the Ben Sparks Survey, ABS A0813, tract 17, being a 7.278-acre tract of land, located at 1130 West Lucas Road. The motion passed unanimously by a 5 to 0 vote.

- 4. Consider the request by Stephen DiNapoli for preliminary plat approval for a parcel of land, being 41.512 acres, part of the John Thompson Survey, Abstract 893 and the G. Ducase Survey, Abstract 270 located on the northeast side of Winningkoff Road and north of Christian Lane, located at 950 Winningkoff Road, 970 Winningkoff Road, and 905 Christian Lane.**

Alternate Commissioner Sussman recused himself from this agenda item due to a conflict of interest.

The following individuals spoke regarding this item:

Kim Nopper, 980 Winningkoff discussed her concerns with the proposed request related to drainage, fencing, neighborhood lighting, tree replacement, and neighborhood entrance.

Andy Nopper, 980 Winningkoff spoke in opposition to the request expressing concerns related to the proposed entrance and drainage.

The Commission discussed the drainage study, plat requirements and reviewed the construction plans, noting the plat met all City requirements.

MOTION: A motion was made by Commissioner Kuykendall, seconded by Commissioner Williams to approve the preliminary plat for a parcel of land, being 41.512 acres, part of the John Thompson Survey, Abstract 893 and the G. Ducase Survey, Abstract 270 located on the northeast side of Winningkoff Road and north of Christian Lane, located at 950 Winningkoff Road, 970 Winningkoff Road, and 905 Christian Lane. The motion passed by a 4 to 1 vote with Commissioner Tolson voting in opposition.

- 5. Consider approval of the minutes of the April 8, 2021 Planning and Zoning Commission meeting.**

MOTION: A motion was made by Commissioner Tolson, seconded by Commissioner Kuykendall to approve the minutes of the April 8, 2021 Planning and Zoning Commission meeting. The motion passed unanimously by a 5 to 0 vote.

- 6. Consider the appointment of a Chairman of the Planning and Zoning Commission to serve for a term ending December 31, 2021 and appoint Vice Chairman if needed.**

MOTION: A motion was made by Commissioner Tolson, seconded by Commissioner Williams to appoint Peggy Rusterholtz as Chairman of the Planning and Zoning Commission

with a term ending December 31, 2021. The motion passed unanimously by a 5 to 0 vote.

MOTION: A motion was made by Chairman Rusterholtz, seconded by Alternate Commissioner Foster to appoint Joe Williams as Vice Chairman of the Planning and Zoning Commission with a term ending December 31, 2021. The motion passed unanimously by a 5 to 0 vote.

Executive Session Agenda

7. Executive Session.

An Executive Session was not held at this meeting.

8. Adjournment.

MOTION: A motion was made Chairman Rusterholtz, seconded by Vice Chairman Williams to adjourn the meeting at 8:20 pm. The motion passed unanimously by a 5 to 0 vote.

Peggy Rusterholtz, Chairman

Stacy Henderson, City Secretary