

FINAL PLANS

NAME OF CONTRACTOR: _____
 DATE OF LETTING: _____
 DATE WORK BEGAN: _____
 DATE WORK COMPLETED: _____
 DATE WORK ACCEPTED: _____
 SUMMARY OF CHANGE ORDERS:

STATE OF TEXAS
 DEPARTMENT OF TRANSPORTATION

PLANS OF PROPOSED
 STATE HIGHWAY IMPROVEMENT

FEDERAL PROJECT NO: CM 2023(702)

CSJ: 1392-01-044, ETC.

FM 1378, ETC.

COLLIN COUNTY

DESIGN IIE	FED. RD. DIV. NO. 6	FEDERAL AID PROJECT NO. CM 2023(702)	HIGHWAY NO. FM 1378, ETC.
GRAPHICS IIE	STATE	DISTRICT DALLAS	COUNTY COLLIN
CHECK JI	TEXAS	DALLAS	COLLIN
CHECK	CONTROL	SECTION 1392	JOB 01 044, ETC.
			SHEET NO. 1

DESIGN SPEED = 45 MPH
 FUNCTIONAL CLASSIFICATION =
 MINOR ARTERIAL
 ADT: 12,400 (YR 2025)
 19,950 (YR 2055)

NOTE:

SPECIFICATIONS ADOPTED BY THE TEXAS DEPARTMENT OF TRANSPORTATION, NOVEMBER 1, 2014, AND THE CONTRACT PROVISIONS LISTED AND DATED AS FOLLOWS SHALL GOVERN ON THIS PROJECT: REQUIRED CONTRACT PROVISIONS FOR ALL FEDERAL-AID CONSTRUCTION CONTRACTS (FORM FHWA 1273, JULY 5, 2022)

Registered Accessibility Specialist (RAS) inspection required. TDLR No. TABS:2022012822

LIMITS: FM 1378: FROM FM 3286
 TO SOUTH OF FM 3286

LIMITS: FM 3286: FROM FM 1378
 TO EAST OF FM 1378

CSJ: 1392-01-044

CSJ: 3476-02-013

ROADWAY = 3,277.67 FT. = 0.621 MI.
 BRIDGE = 0.000 FT. = 0.000 MI.
 TOTAL = 3,277.67 FT. = 0.621 MI.

ROADWAY = 2,782.82 FT. = 0.527 MI.
 BRIDGE = 0.000 FT. = 0.000 MI.
 TOTAL = 2,782.82 FT. = 0.527 MI.

FOR THE CONSTRUCTION OF: INTERSECTION & OPERATIONAL IMPROVEMENT
 CONSISTING OF: CONSTRUCT INTERSECTION IMPROVEMENTS (SIDEWALKS & TURN LANES)

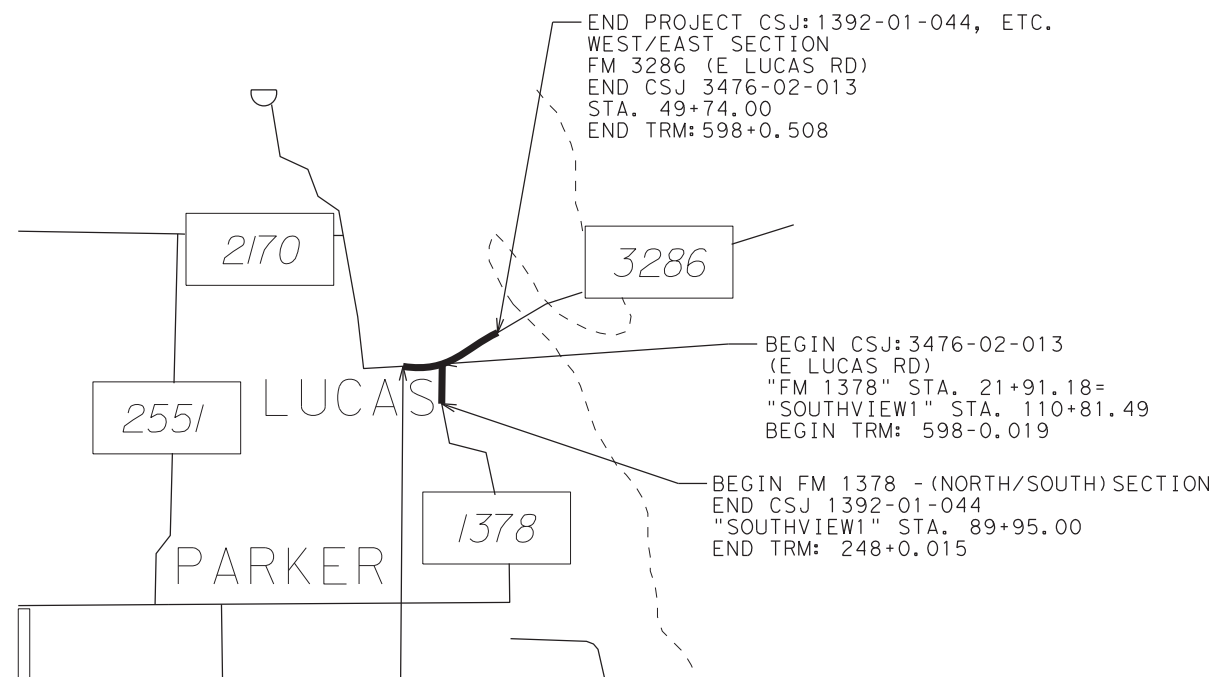
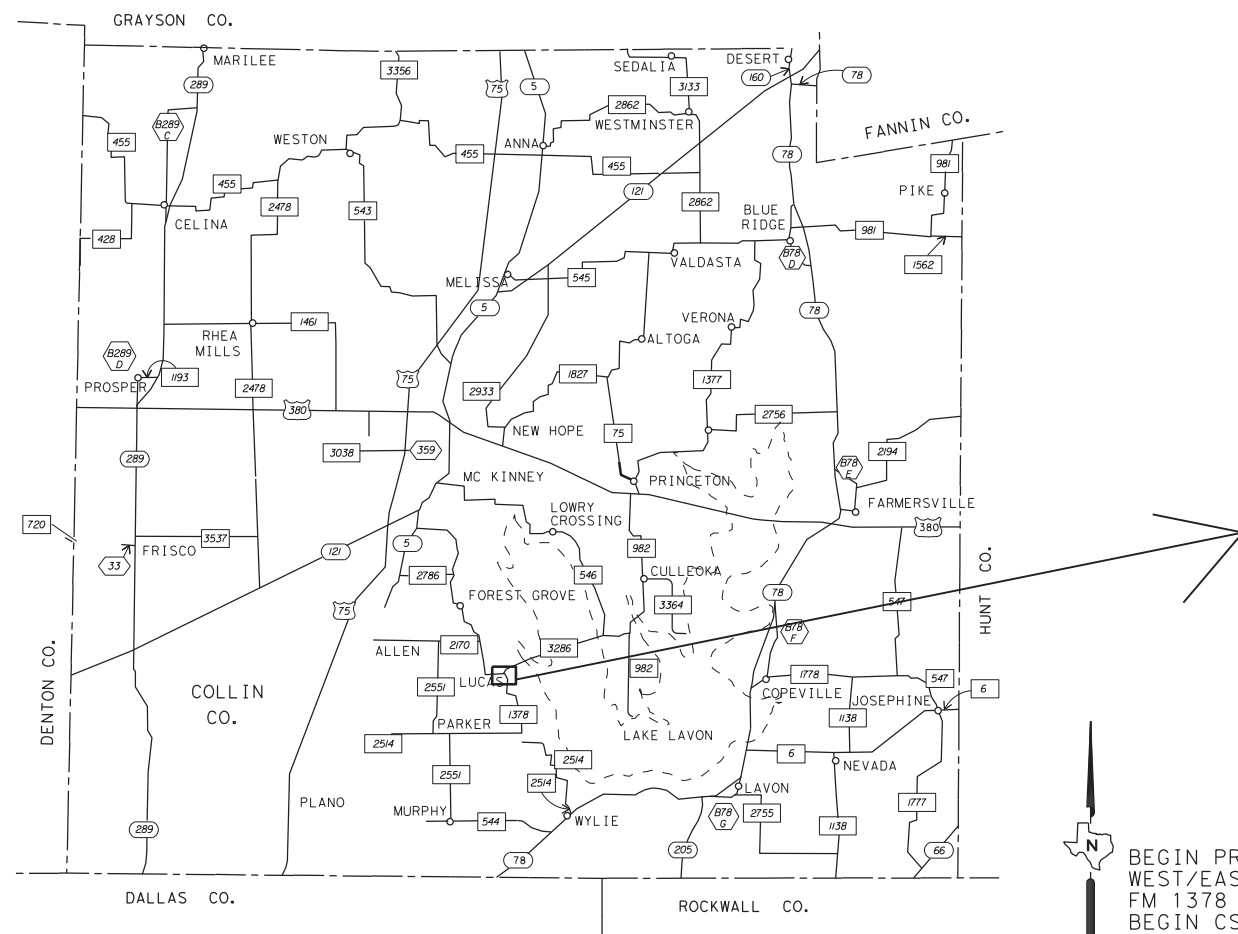

TEXAS DEPARTMENT OF TRANSPORTATION

BEGIN PROJECT CSJ: 1392-01-044, ETC.
 WEST/EAST SECTION
 FM 1378 (W LUCAS RD)
 BEGIN CSJ 1392-01-044
 STA. 10+00.00
 BEGIN TRM: 246+1.434

SUBMITTED FOR LETTING: 02-28-23
 Abraham El Saad, P.E.
 DESIGN ENGINEER

RECOMMENDED 2/28/2023
 DocuSigned by: James P. Campbell, P.E.
 98671C109B6A4C3...
 PLANNING & DEVELOPMENT

RECOMMENDED 2/28/2023
 DocuSigned by: Jennifer Vorster, P.E.
 4DB68ED9336D4F7...

APPROVED 2/28/2023
 DocuSigned by: Casson Clemens, P.E.
 A879E0D10CD6464... NEER

WORK WAS COMPLETED ACCORDING TO THE PLANS AND CONTRACT.

Signature of Registrant, P.E. & Date

COLLIN COUNTY
 SCALE 0 1 2 3 4 5 6 MI.
 DALLAS DISTRICT

EQUATIONS: NONE
 EXCEPTIONS: NONE
 RAILROAD CROSSINGS: NONE

DATE: 2/28/2023 TIME: 11:08:59 AM FILE: c:\txdot\pw\onlime\txdot5\ibrahim.eisaad\0480372\100%_FM_1378_Index_of_Sheets.dgn

SHEET	DESCRIPTION	
1	I. GENERAL	
2	TITLE SHEET	
3	INDEX OF SHEETS	
4-11	PROJECT LAYOUT	
12,12A-12J	TYPICAL SECTIONS	
13,13A-13E	GENERAL NOTES	
14	ESTIMATE & QUANTITY	
15	TRAFFIC CONTROL PLAN SUMMARY	
16	REMOVAL SUMMARY	
17	ROADWAY SUMMARY	
18	DRAINAGE SUMMARY	
19	PAVEMENT MARKING SUMMARY	
20	EARTHWORK SUMMARY	
21	SW3P SUMMARY	
22	SIGNING SUMMARY	
23-27	TRAFFIC SIGNAL SUMMARY	
	SUMMARY OF SMALL SIGNS	
	II. TRAFFIC CONTROL PLAN	
28	TRAFFIC CONTROL PLAN - NARRATIVE	
29-32	TRAFFIC CONTROL PLAN - PHASE 1 - STAGE 1-A - TYPICAL SECTION	
33-37	TRAFFIC CONTROL PLAN - PHASE 1 STAGE 1-A	
38	TRAFFIC CONTROL PLAN - PHASE 1 - STAGE 1-B - TYPICAL SECTION	
39-41	TRAFFIC CONTROL PLAN - PHASE 1 STAGE 1-B	
42	TRAFFIC CONTROL PLAN - PHASE 1 - STAGE 1-C - TYPICAL SECTION	
43-45	TRAFFIC CONTROL PLAN - PHASE 1 STAGE 1-C	
46-50	TRAFFIC CONTROL PLAN - PHASE 2 - TYPICAL SECTION	
51-55	TRAFFIC CONTROL PLAN - PHASE 2 STAGE 2	
56-58	TRAFFIC CONTROL PLAN - PHASE 2 STAGE 1- TYPICAL SECTION	
59-63	TRAFFIC CONTROL PLAN - PHASE 2 STAGE 1	
64	TRAFFIC CONTROL PLAN - PHASE 2 STAGE 2- TYPICAL SECTION	
65-69	TRAFFIC CONTROL PLAN - PHASE 2 STAGE 2	
70	CRASH CUSHION SUMMARY SHEET	
71	TCP MISCELLANEOUS DETAILS	
72-73	TRAFFIC CONTROL PLAN - CULVERT A	
74-75	TRAFFIC CONTROL PLAN - CULVERT B	
76-77	TRAFFIC CONTROL PLAN - CULVERT C	
	TRAFFIC CONTROL PLAN STANDARDS	
78-89	BC (1)-21 THRU BC (12)-21*	
90	TCP (2-1)-18*	
91	TCP (2-2)-18*	
92	TCP (2-3)-18*	
93	TCP (2-4)-18*	
94	TCP (2-5)-18*	
95	TCP (2-6)-18*	
96	TCP (3-1)-13*	
97	TCP (3-2)-13*	
98	TCP (3-3)-14*	
99	WZ (STPM)-13*	
100	WZ (TD)-17*	
101	WZ (BTS-1)-13*	
102	WZ (BTS-2)-13*	
103	WZ (UL)-13*	
104	WZ (BRK)-13*	
105	TE (HMAC)-11*	
106-107	CSB (1)-10*	
108	ABSORB (M)-19*	
109	SLED-19*	
	III. ROADWAY DETAILS	
110	SURVEY CONTROL INDEX SHEET	
111	HORIZONTAL/VERTICAL CONTROL MAP	
112	HORIZONTAL CONTROL LAYOUT	
113-117	HORIZONTAL ALIGNMENT DATA	
118	EXISTING PAVEMENT CORES	
119-122	REMOVAL LAYOUT	
123-128	PLAN AND PROFILE	
129-131	CROSS STREET PROFILES	
132-136	DRIVEWAY PROFILES	
137	INTERSECTION CONTOURS	
138	MISCELLANEOUS ROADWAY CONTOUR	
139-141	MISCELLANEOUS ROADWAY DETAILS	
	ROADWAY DETAILS STANDARDS	
142	CCCG-22*	
143-144	CRCP(1)-20*	
145	JS-14*	
146	LJD(1-1)-07 (DAL)*	
147	M-10*	
147A	GF(31)-19*	
147B	GF(31)DAT-19*	

147C	SGT(10S)31-16*
147D	SGT(11S)31-18*
147E	SGT(12S)31-18*
147F	SGT(15)31-20*
147G	GF(31)MS-19*
148-151	PED-18*
152-154	PRD-13*
	IV. RETAINING WALL
	NONE
	V. DRAINAGE DETAILS
155-156	EXTERIOR DRAINAGE AREA MAP
157-159	INTERIOR DRAINAGE AREA MAP
160	STORM SEWER RUNOFF CALCULATIONS
161	STORM SEWER INLET CALCULATIONS
162	STORM SEWER CALCULATIONS
163-164	STORM SEWER PLAN/PROFILE NETWORK A1
165	STORM SEWER PLAN/PROFILE EDGEFIELD LATERAL
166	STORM SEWER PLAN/PROFILE NETWORK A2
167-168	STORM SEWER PLAN/PROFILE NETWORK A3
169	STORM SEWER PLAN/PROFILE NETWORK A4
170	STORM SEWER PLAN/PROFILE NETWORK A5
171	STORM SEWER PLAN/PROFILE NETWORK A6
172-173	STORM SEWER PLAN/PROFILE NETWORK B1
174-175	STORM SEWER PLAN/PROFILE NETWORK B2
176	STORM SEWER PLAN/PROFILE NETWORK B3
177	STORM SEWER PLAN/PROFILE NETWORK B4
178	STORM SEWER PLAN/PROFILE NETWORK D1
179-184	DITCH LAYOUT SHEETS
185-186	CULVERT A LAYOUT
187-189	CULVERT B LAYOUT
190-193	CULVERT C LAYOUT
194-195	CULVERT A CONTOURS
196-197	CULVERT B CONTOURS
198	CULVERT C CONTOURS
199	MISCELLANEOUS DRAINAGE DETAILS
	DRAINAGE DETAILS STANDARDS
200	BCS*
201	PB*
202-203	PCU*
204-205	PSL*
206	PW*
207	CH-PW-0*
208	CH-PW-S*
209-210	SRR*
211	PRM*
212	SCP-6*
213	SCP-MD*
214	ECD*
215-216	PR11*
	VI. UTILITIES TXDOT SUE DATA
217-226	EXISTING UTILITY MAP QUALITY LEVEL B
227-243, 243A-243J	EXISTING UTILITY MAP QUALITY LEVEL A
	VII. BRIDGE
	NONE
	VIII. TRAFFIC
	SIGNAL SHEETS
244	SUMMARY OF SMALL SIGNS
245-246	TEMPORARY TRAFFIC SIGNAL -FM 1378 @ FM 3286 PHASE 1 STAGE 1
247-249	TEMPORARY TRAFFIC SIGNAL -FM 1378 @ FM 3286 PHASE 1 STAGE 2
250-251	TEMPORARY TRAFFIC SIGNAL -FM 1378 @ FM 3286 PHASE 2 STAGE 1
252-253	TEMPORARY TRAFFIC SIGNAL -FM 1378 @ FM 3286 PHASE 2 STAGE 2
254-258	PERMANENT TRAFFIC SIGNAL- FM 1378 @ FM 3286
	SIGNING SHEETS
259-261	SIGNING LAYOUTS
262	GUIDE SIGN DETAILS
263-268	PAVEMENT MARKINGS LAYOUTS
	TRAFFIC STANDARDS
269-273	ED (1)-14, ED (3)-14 THRU ED (6)-14**
274-275	ED (8)-14 THRU ED (9)-14**
276-277	LMA (1) -12 (DAL) THRU LMA(2)- 12 (DAL)**
278	LMA(3)-12**
279-280	LMA (4)-12 (DAL) THRU LMA (5)-12 (DAL)**
281	MA-C-12**
282	MA-D-12(DAL)**
283	MA-DPD-20**
284	LUM-A-12**
285	TS-FD-12 **

286	RVDS-18 (DAL)**
287	VDZ-04 (DAL)**
288	INSTALLATION OF BBU / EVP (DAL)**
289	PEDESTRIAN SIGNAL HEAD DETAILS (DAL)**
290	TRAFFIC SIGNAL HEAD DETAILS (DAL)**
291-293	CONSTRUCTION DETAILS FOR SPAN WIRE MOUNTED TRAFFIC SIGNALS (DAL)**
294	TS-CF-21**
295-298	RIP (1)-19 THRU RIP(4)-19 **
299-300	SMA-80(1) - 12 (DAL) THRU SMA (2)-12 (DAL)**
301	TS-BP-20**
302-302A	RID (1)-20 THRU RID(2)-20**
303-305	TSR (3)-13 THRU TSR (5)-13***
306	SMD (GEN)-08***
307	SMD (SLIP-1)-08 (DAL)***
308-309	SMD (SLIP-2)-08 THRU SMD (SLIP-3)-08***
310	TWO-LANE HIGHWAY CURVE SIGNING & MARKINGS (DAL)***
311-316	D&OM (1) -20 THRU D&M (6)-20***
317-320	PM (1) - 22 THRU PM (4) -22A*
	XI. ENVIRONMENTAL ISSUES
321-322	STORMWATER POLLUTION PREVENTION PLAN (SW3P)
323	ENVIRONMENTAL PERMITS, ISSUES AND COMMITMENTS (EPIC)
324	OMITTED
325-328	SW3P SITE MAP- PHASE 1 STAGE 1
329-332	SW3P SITE MAP- PHASE 1 STAGE 2
333-336	SW3P SITE MAP- PHASE 2 STAGE 1
	ENVIRONMENTAL ISSUES STANDARDS
337-339	EC (1)-16 THRU EC (3)-16*
340-342	EC (9)-16*
343	VEGETATION ESTABLISHMENT SHEET (DAL)*
344	SW3P SIGN SHEET (DAL)*
	X. UTILITIES: NTMWD WATERLINE RELOCATION PLANS
345	COVER SHEET
346-347	GENERAL NOTES
348	QUANTITY SHEET
349	PROPOSED 20" WATERLINE INDEX SHEET
350-353	PROPOSED 20" WATERLINE
354	TRENCH DETAILS
355-357	CONSTRUCTION DETAILS

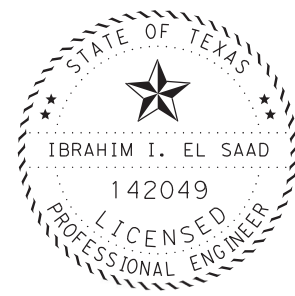
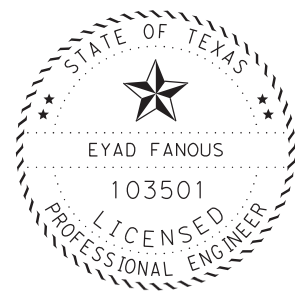

DocuSigned by:
Eyad Fanous, P.E. 2/28/2023
 Signature of Registrant & Date
 7C074158193648D
 **THE STANDARD SHEETS SPECIFICALLY IDENTIFIED ABOVE HAVE BEEN SELECTED BY ME OR UNDER MY RESPONSIBLE SUPERVISION AS BEING APPLICABLE TO THIS PROJECT.

Abraham I. El Saad, P.E. 2-28-23
 Signature of Registrant & Date
 **THE STANDARD SHEETS SPECIFICALLY IDENTIFIED ABOVE HAVE BEEN SELECTED BY ME OR UNDER MY RESPONSIBLE SUPERVISION AS BEING APPLICABLE TO THIS PROJECT.



Mark A. Aboso, P.E. 2/28/2023
 Signature of Registrant & Date
 ***THE STANDARD SHEETS SPECIFICALLY IDENTIFIED ABOVE HAVE BEEN SELECTED BY ME OR UNDER MY RESPONSIBLE SUPERVISION AS BEING APPLICABLE TO THIS PROJECT.

Texas Department of Transportation				© 2023
FM 1378 AT FM 3286				
INDEX OF SHEETS				
				SHEET 1 OF 1
DESIGN	FED. RD. DIV. NO.	FEDERAL AID PROJECT NO.	HIGHWAY NO.	
J1	6	SEE TITLE SHEET	FM 1378, ETC.	
GRAPHICS	J1	STATE	DISTRICT	COUNTY
CHECK	IIE	TEXAS	DAL	COLLIN
CHECK	IIE	CONTROL	SECTION	JOB
		1392	01	044, ETC.
				2

DATE: 10/29/2022 TIME: 11:29:06 PM FILE: c:\txdot\pw\onl\me\txdot5\james.igwe\d0480386\Project Layout Sheets.dgn

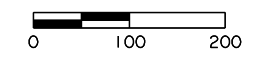
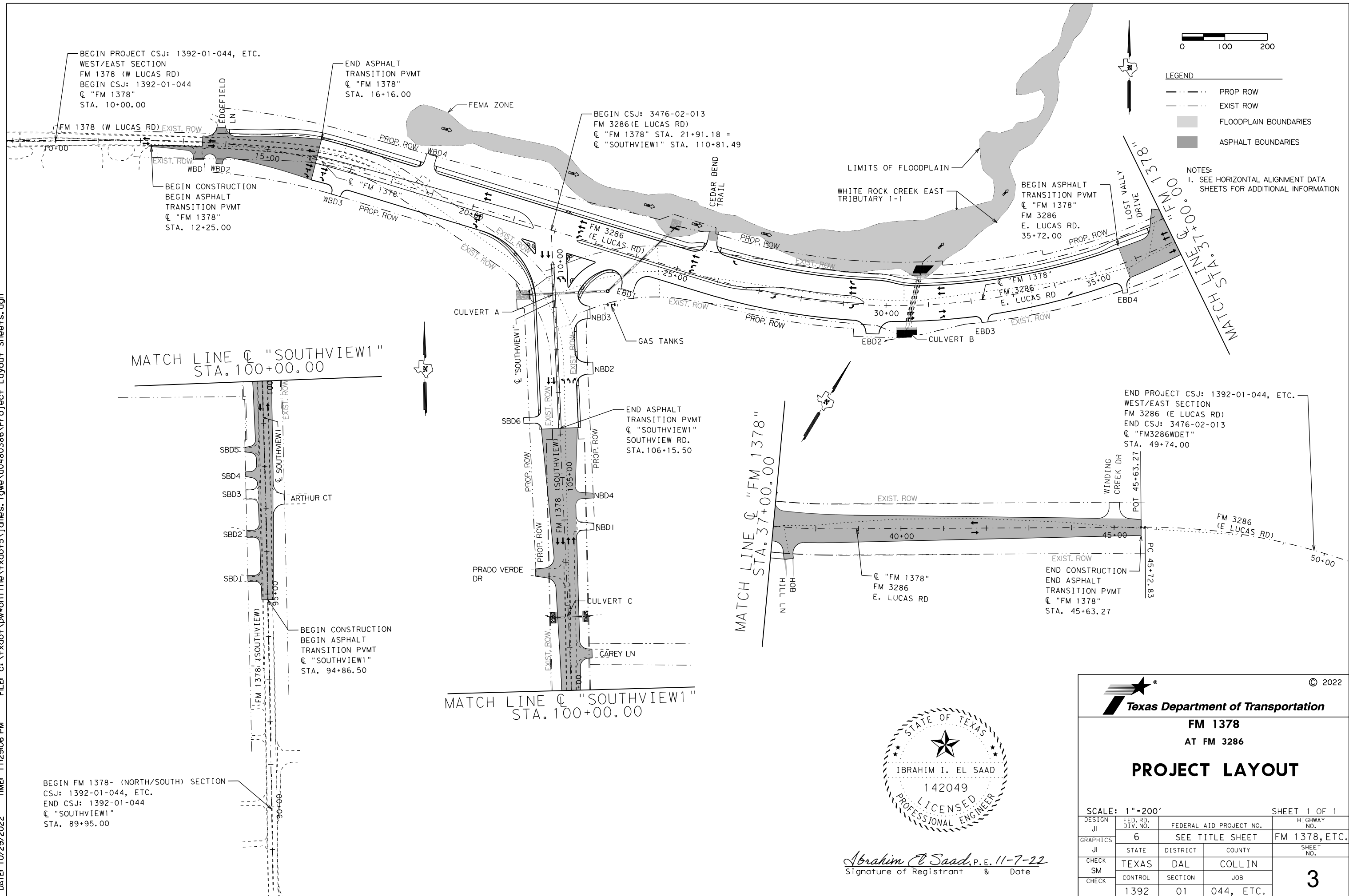

- LEGEND**
- PROP. ROW
 - - - EXIST. ROW
 - ▭ FLOODPLAIN BOUNDARIES
 - ▭ ASPHALT BOUNDARIES

NOTES:
 1. SEE HORIZONTAL ALIGNMENT DATA SHEETS FOR ADDITIONAL INFORMATION

MATCH LINE @ "SOUTHVIEW1"
 STA. 100+00.00

MATCH LINE @ "FM 1378"
 STA. 37+00.00

END PROJECT CSJ: 1392-01-044, ETC.
 WEST/EAST SECTION
 FM 3286 (E LUCAS RD)
 END CSJ: 3476-02-013
 @ "FM3286WDET"
 STA. 49+74.00

BEGIN FM 1378- (NORTH/SOUTH) SECTION
 CSJ: 1392-01-044, ETC.
 END CSJ: 1392-01-044
 @ "SOUTHVIEW1"
 STA. 89+95.00

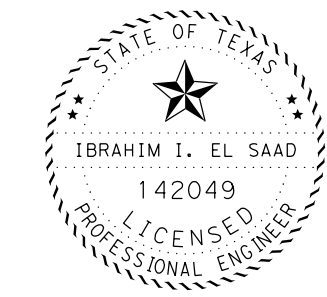

Abraham El Saad, P.E. 11-7-22
 Signature of Registrant & Date

© 2022

Texas Department of Transportation

FM 1378
AT FM 3286

PROJECT LAYOUT

SCALE: 1"=200' SHEET 1 OF 1

DESIGN	JJ	FED. RD. DIV. NO.	6	FEDERAL AID PROJECT NO.	SEE TITLE SHEET	HIGHWAY NO.	FM 1378, ETC.
GRAPHICS	JJ	STATE	TEXAS	DISTRICT	DAL	COUNTY	COLLIN
CHECK	SM	CONTROL	1392	SECTION	01	JOB	044, ETC.
CHECK							3

DATE: 10/30/2022 TIME: 12:38:25 AM FILE: c:\txdot\pw\onl\me\txdot5\james.igwe\d0467417\Existing Typical Section Sheets.dgn

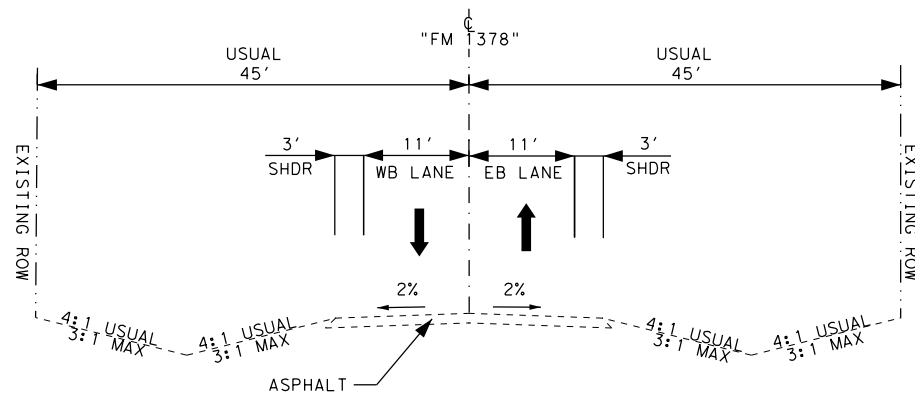

EXISTING TYPICAL SECTION FM 1378 (W LUCAS R.D.)
 @ "FM 1378" STA. 12+25.00 TO STA. 21+91.18

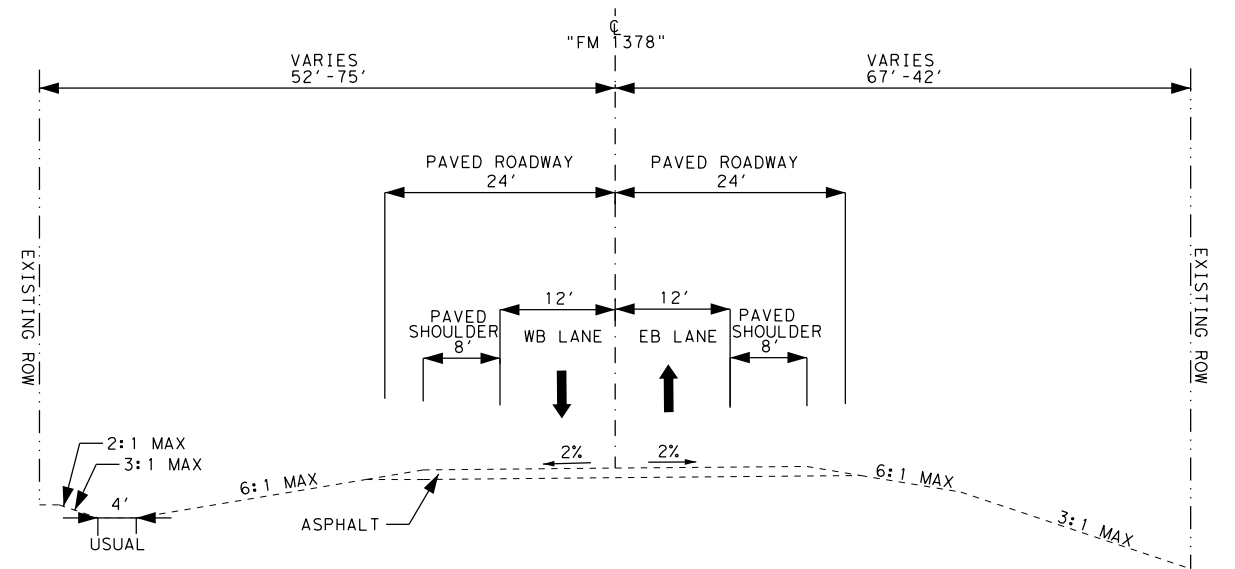

EXISTING TYPICAL SECTION (FM 3286/E LUCAS RD.)
 @ "FM 1378" STA. 21+91.18 TO STA. 45+63.28

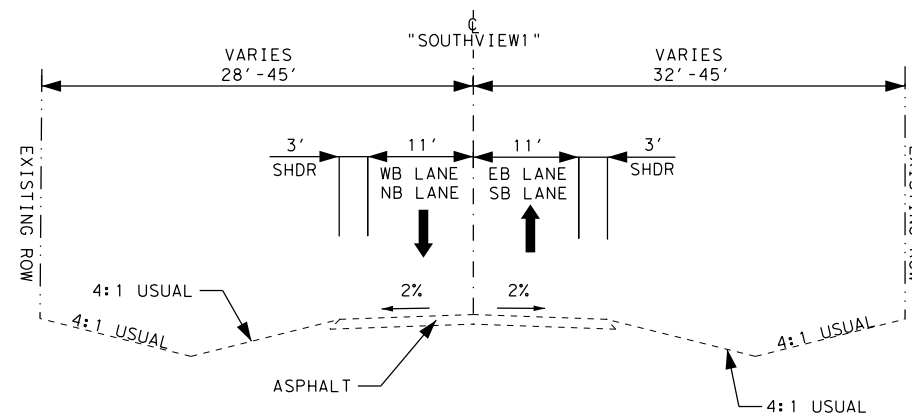

EXISTING TYPICAL SECTION SOUTHVIEW DR.
 @ "SOUTHVIEW1" STA. 94+86.50 TO STA. 110+81.49

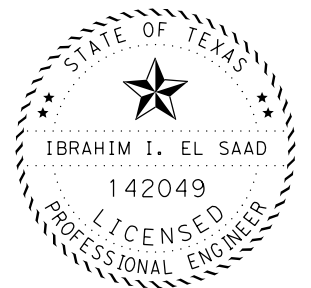

Ibrahim I. Saad, P.E. 11-7-22
 Signature of Registrant & Date

				© 2022
FM 1378 AT FM 3286 TYPICAL SECTIONS (EXISTING)				
N. T. S.				SHEET 1 OF 8
DESIGN	FED. RD. DIV. NO.	FEDERAL AID PROJECT NO.		HIGHWAY NO.
IIE	6	SEE TITLE SHEET		FM 1378, ETC.
GRAPHICS	STATE	DISTRICT	COUNTY	SHEET NO.
IIE	TEXAS	DAL	COLLIN	
CHECK	CONTROL	SECTION	JOB	4
CHECK	1392	01	044, ETC.	

DATE: 10/30/2022 TIME: 12:38:27 AM FILE: c:\txdot\pw\onl\ine\txdot5\james.igwe\d0467417\Existing Typical Section Sheets.dgn

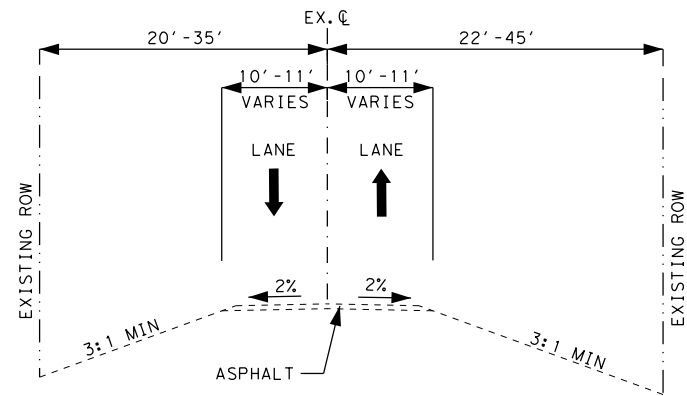

EXISTING TYPICAL SECTION
EDGEFIELD LN. & CEDAR BEND TR.

CL "EDGEFD" STA. 10+13.59 TO STA. 10+37.45
CL "CEDARTR2" STA. 10+20.97 TO STA. 11+77.04

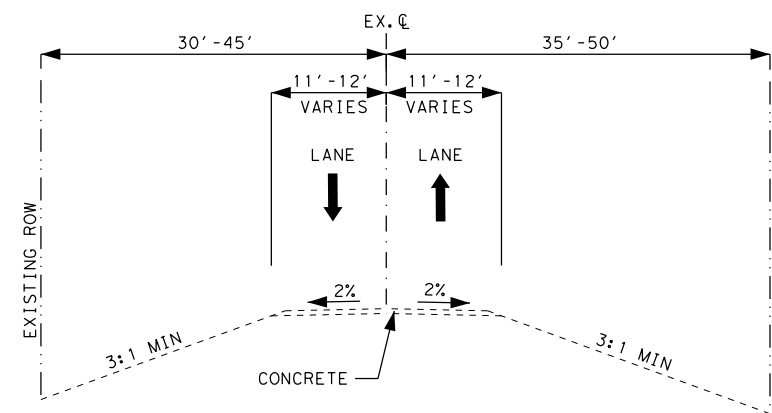

EXISTING TYPICAL SECTIONS
WINDING CREEK DR. & ARTHUR CT.

CL "WINDCK" STA. 0+17.76 TO STA. 0+59.16
CL "ARTHURCT" STA. 10+14.19 TO STA. 10+43.00

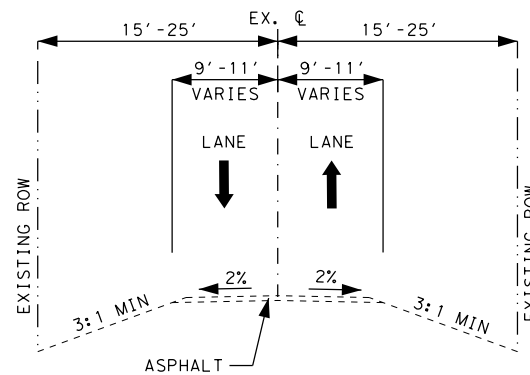

EXISTING TYPICAL SECTIONS
LOST VALLEY DR., HOB HILL LN.,
PRADO VERDE DR., & CAREY LN.

CL "LOSTVD" STA. 10+22.47 TO STA. 11+01.57
CL "HOBLN" STA. 10+20.09 TO STA. 10+74.65
CL "PRADO" STA. 10+07.18 TO STA. 10+72.76
CL "CAREYLN" STA. 10+17.03 TO STA. 10+52.00

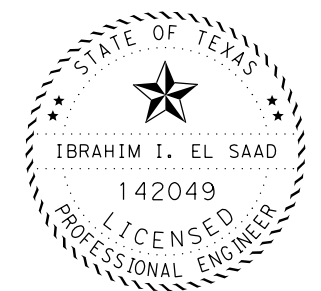

Abraham El Saad, P.E. 11-7-22
Signature of Registrant & Date



© 2022

FM 1378
AT FM 3286
TYPICAL SECTIONS
(EXISTING)

N. T. S.			SHEET 2 OF 8
DESIGN	FED. RD. DIV. NO.	FEDERAL AID PROJECT NO.	HIGHWAY NO.
IIE	6	SEE TITLE SHEET	FM 1378, ETC.
GRAPHICS	STATE	DISTRICT	COUNTY
IIE	TEXAS	DAL	COLLIN
CHECK	CONTROL	SECTION	JOB
	1392	01	044, ETC.
			5

FILE: c:\txdot\pw\onl\ine\txdot5\ibrahim.elsaad\0467417\Proposed Typical Sections Sheets.dgn

TIME: 9:44:55 AM

DATE: 2/9/2023

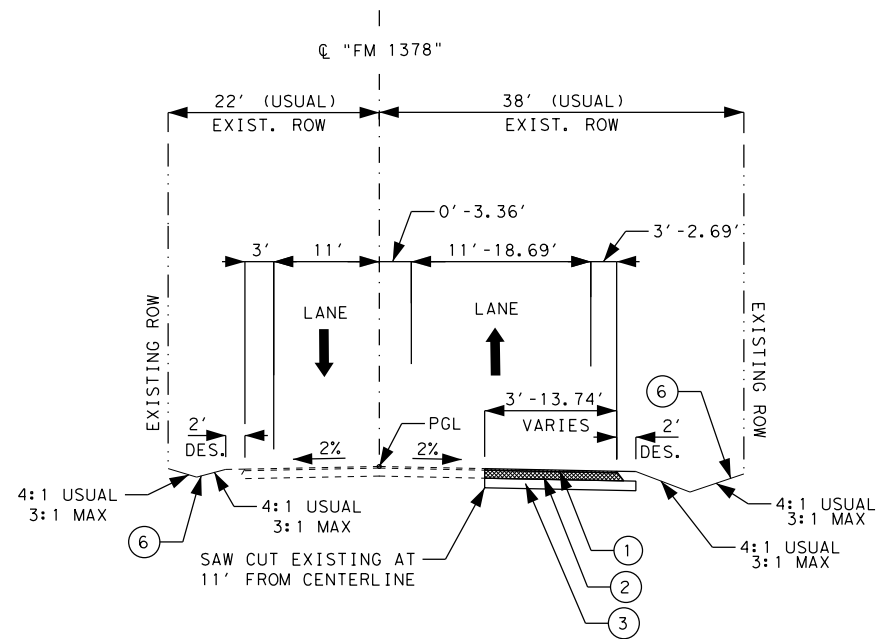

PROPOSED TYPICAL SECTION FM 1378 (W LUCAS RD)
 ASPHALT TRANSITION PVMT
 CL "FM 1378" STA. 12+25.00 TO STA. 13+45.00

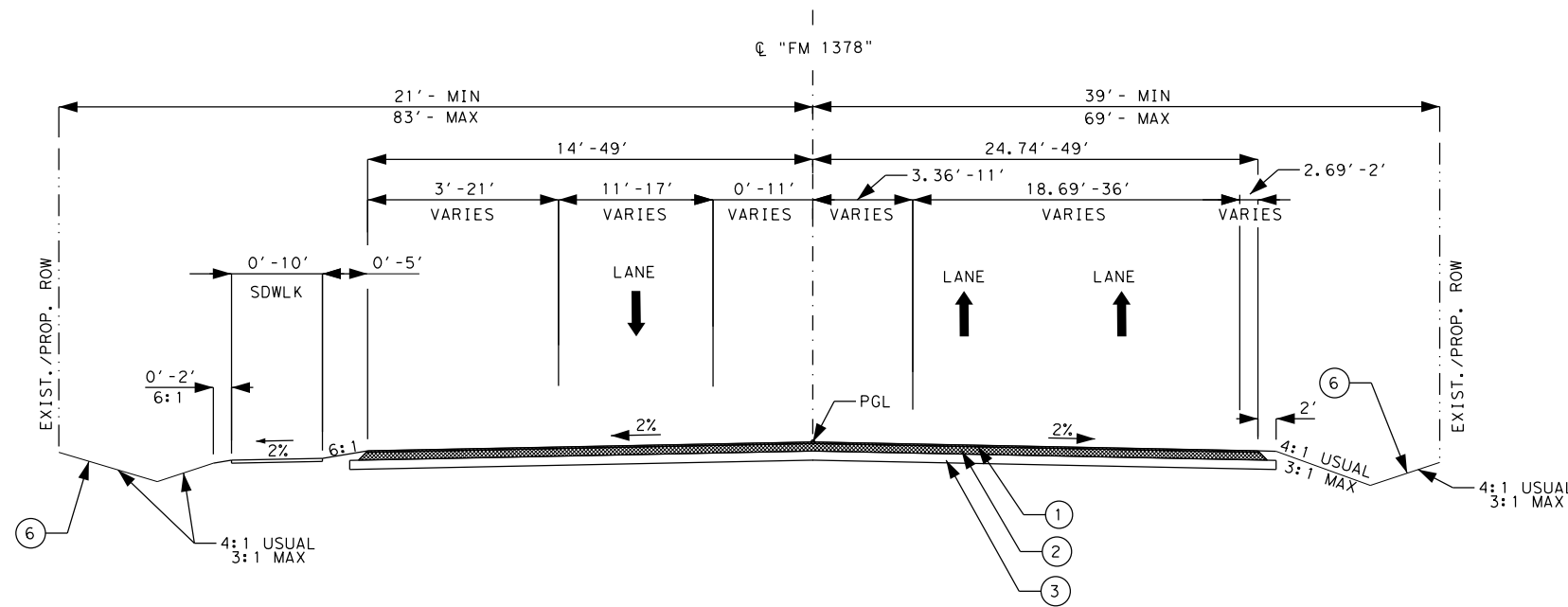

PROPOSED TYPICAL SECTION FM 1378 (E LUCAS RD)
 ASPHALT TRANSITION PVMT
 CL "FM 1378" STA. 13+45.00 TO STA. 16+16.00

LEGEND

- ① - 2" SUPERPAVE MIXTURES SP-C PG64-22 SAC-B
- ② - 6" SUPERPAVE MIXTURES SP-B PG64-22
- ③ - 8" LTS WITH 5% LIME (EXIST)
- ④ - CONC PVMT (CONT REINF - CRCP) (8')
- ⑤ - 4" SUPERPAVE MIXTURES SP-B PG64-22
- ⑥ - 4" COMPOST MANUF TOP SOIL & SODDING
- ⑦ - CONC SIDEWALKS (4')
- ⑧ - CONC MEDIAN

NOTE:

- X-SLOPE CONTROLLED BY INTERSECTION CONTOURS
- CL "FM 1378" STA. 20+23.00 TO STA. 23+70.00
- CL "SOUTHVIEW1" STA. 109+19.00 TO STA. 110+81.49

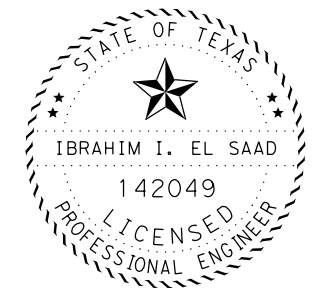

Ibrahim I. El Saad, P.E. 2-9-23
 Signature of Registrant & Date

		© 2023	
FM 1378 AT FM 3286 TYPICAL SECTIONS (PROPOSED)			
N. T. S.		SHEET 3 OF 8	
DESIGN	FED. RD. DIV. NO.	FEDERAL AID PROJECT NO.	HIGHWAY NO.
IIE	6	SEE TITLE SHEET	FM 1378, ETC.
GRAPHICS	STATE	DISTRICT	COUNTY
IIE	TEXAS	DAL	COLLIN
CHECK	CONTROL	SECTION	JOB
	1392	01	044, ETC.
			6

FILE: c:\txdot\pw\onl\ine\txdot5\ibrahim.e\saad\0467417\Proposed Typical Sections Sheets.dgn

DATE: 2/9/2023 TIME: 9:45:42 AM

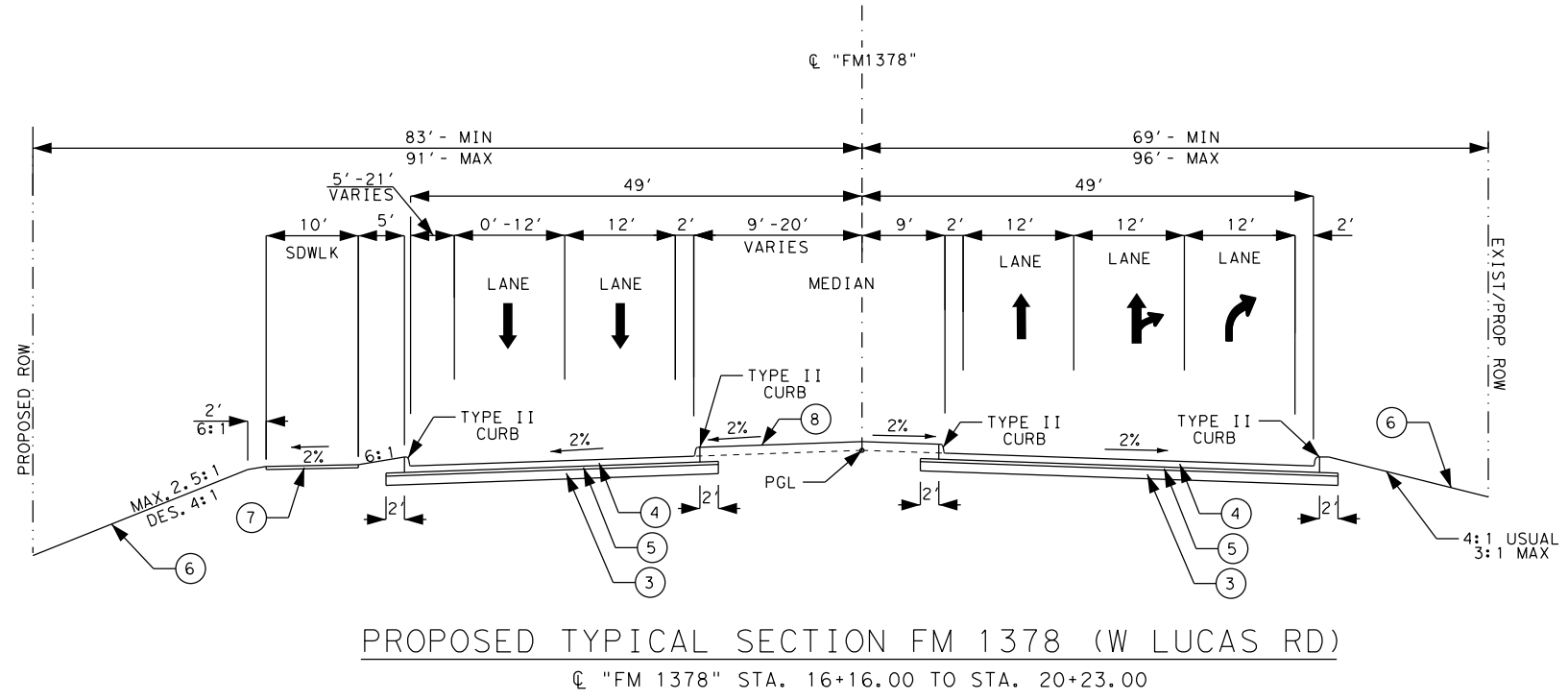

PROPOSED TYPICAL SECTION FM 1378 (W LUCAS RD)
 @ "FM 1378" STA. 16+16.00 TO STA. 20+23.00

NOTE:
 SEE INTERSECTION CONTOURS AND PLAN & PROFILE SHEETS
 FOR INTERSECTION DETAILS AND TYPICAL SECTIONS FROM
 @ "FM 1378" STA. 20+23.00 TO STA. 23+70.00
 @ "SOUTHVIEW1" STA. 109+19.00 TO STA. 110+81.49

- LEGEND**
- ① - 2" SUPERPAVE MIXTURES SP-C PG64-22 SAC-B
 - ② - 6" SUPERPAVE MIXTURES SP-B PG64-22
 - ③ - 8" LTS WITH 5% LIME (EXIST)
 - ④ - CONC PVMT (CONT REINF - CRCP) (8')
 - ⑤ - 4" SUPERPAVE MIXTURES SP-B PG64-22
 - ⑥ - 4" COMPOST MANUF TOP SOIL & SODDING
 - ⑦ - CONC SIDEWALKS (4')
 - ⑧ - CONC MEDIAN
- NOTE:**
- X-SLOPE CONTROLLED BY INTERSECTION CONTOURS
 - @ "FM 1378" STA. 20+23.00 TO STA. 23+70.00
 - @ "SOUTHVIEW1" STA. 109+19.00 TO STA. 110+81.49

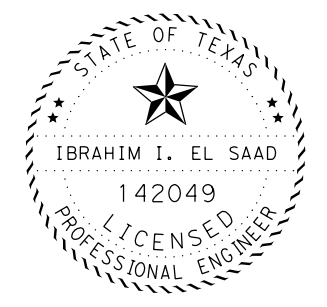

Ibrahim El Saad, P.E. 2-9-23
 Signature of Registrant & Date

© 2023

**FM 1378
 AT FM 3286
 TYPICAL SECTIONS
 (PROPOSED)**

N. T. S.			SHEET 4 OF 8
DESIGN IIE	FED. RD. DIV. NO. 6	FEDERAL AID PROJECT NO. SEE TITLE SHEET	HIGHWAY NO. FM 1378, ETC.
GRAPHICS IIE	STATE TEXAS	DISTRICT DAL	COUNTY COLLIN
CHECK	CONTROL 1392	SECTION 01	JOB 044, ETC.

7

FILE: c:\txdot\pw\onl\ine\txdot5\ibrahim.elsaad\0467417\Proposed Typical Sections Sheets.dgn

TIME: 9:46:09 AM

DATE: 2/9/2023

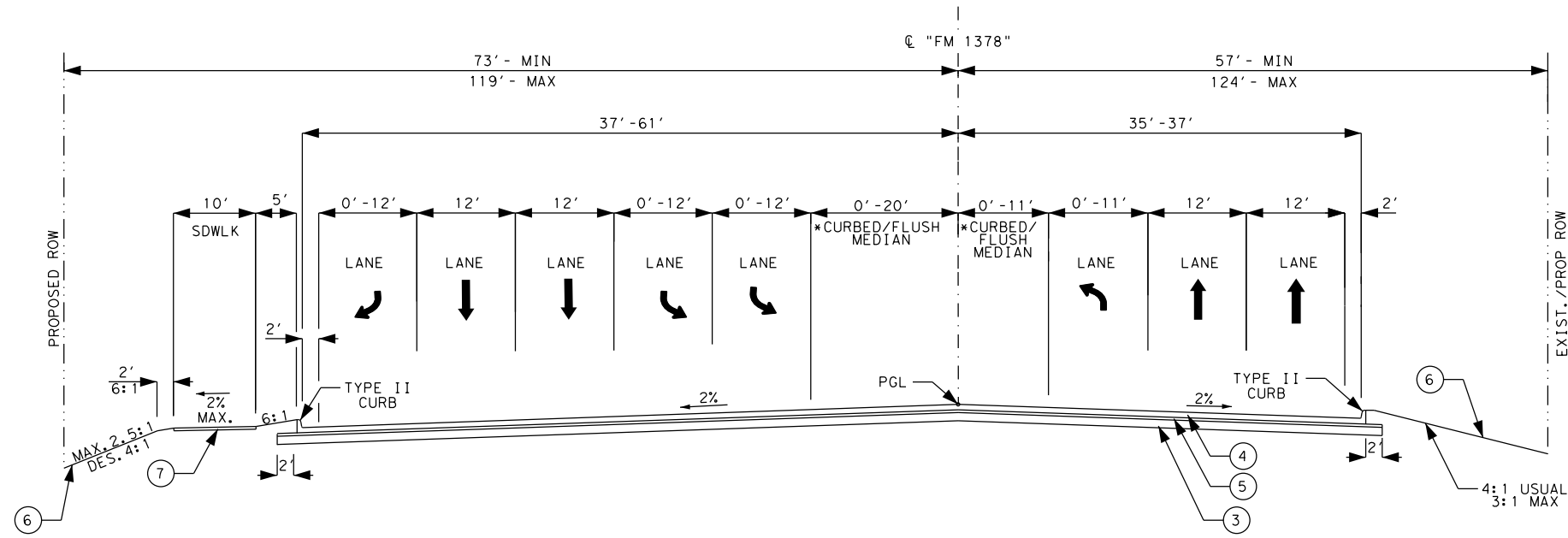

PROPOSED TYPICAL SECTION FM 3286 (E LUCAS RD)
 @ "FM 1378" STA. 23+70.00 TO STA. 35+72.00

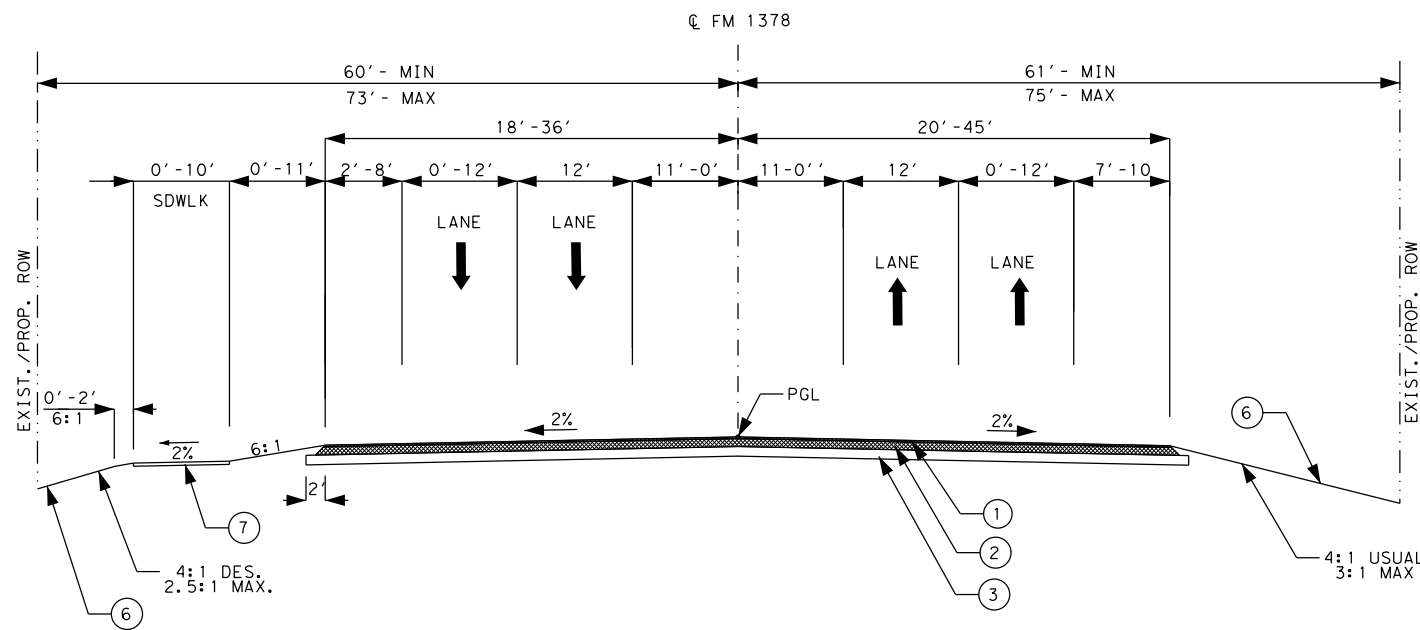

PROPOSED TYPICAL SECTION (FM 3286/E LUCAS RD)
 ASPHALT TRANSITION PVMT
 @ "FM 1378" STA. 35+72.00 TO STA. 45+63.27

LEGEND

- ① - 2" SUPERPAVE MIXTURES SP-C PG64-22 SAC-B
- ② - 6" SUPERPAVE MIXTURES SP-B PG64-22
- ③ - 8" LTS WITH 5% LIME (EXIST)
- ④ - CONC PVMT (CONT REINF - CRCP) (8')
- ⑤ - 4" SUPERPAVE MIXTURES SP-B PG64-22
- ⑥ - 4" COMPOST MANUF TOP SOIL & SODDING
- ⑦ - CONC SIDEWALKS (4')
- ⑧ - CONC MEDIAN

NOTE:

- X-SLOPE CONTROLLED BY INTERSECTION CONTOURS
- @ "FM 1378" STA. 20+23.00 TO STA. 23+70.00
- @ "SOUTHVIEW1" STA. 109+19.00 TO STA. 110+81.49

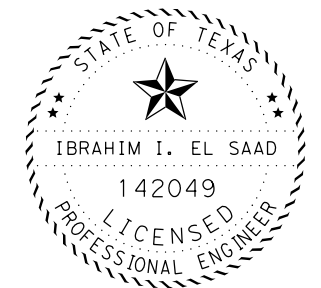

Ibrahim El Saad, P.E. 2-9-23
 Signature of Registrant & Date



FM 1378
 AT FM 3286
**TYPICAL SECTIONS
 (PROPOSED)**

N. T. S.			SHEET 5 OF 8
DESIGN	FED. RD. DIV. NO.	FEDERAL AID PROJECT NO.	HIGHWAY NO.
IIE	6	SEE TITLE SHEET	FM 1378, ETC.
GRAPHICS	STATE	DISTRICT	COUNTY
IIE	TEXAS	DAL	COLLIN
CHECK	CONTROL	SECTION	JOB
CHECK	1392	01	044, ETC.
			8

FILE: c:\txdot\pw\onl\ine\txdot5\ibrahim.e\saad\0467417\Proposed Typical Sections Sheets.dgn

TIME: 9:46:25 AM

DATE: 2/9/2023

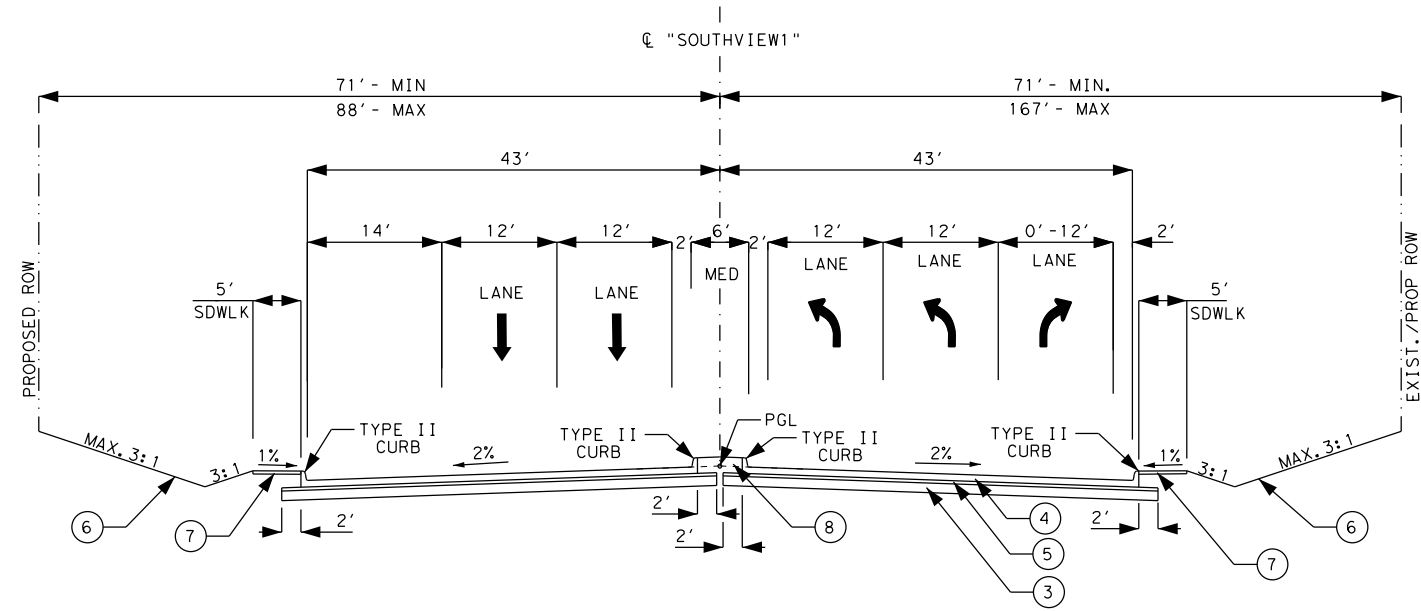

PROPOSED TYPICAL SECTION FM 1378 (SOUTHVIEW DR.)
 @ "SOUTHVIEW1" STA. 106+15.50 TO STA. 109+19.00

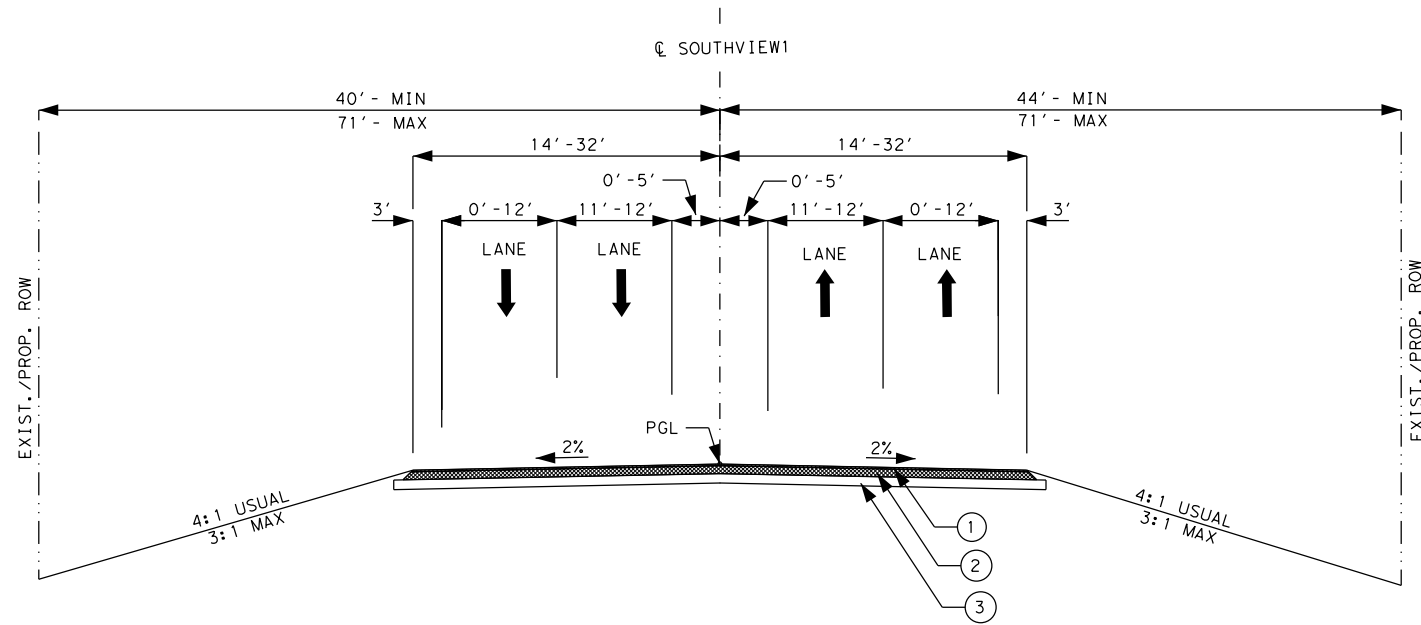

PROPOSED TYPICAL SECTION FM 1372 (SOUTHVIEW)
 ASPHALT TRANSITION PVMT
 @ "FM 1378" STA. 94+86.50 TO STA. 106+15.50

LEGEND

- ① - 2" SUPERPAVE MIXTURES SP-C PG64-22 SAC-B
- ② - 6" SUPERPAVE MIXTURES SP-B PG64-22
- ③ - 8" LTS WITH 5% LIME (EXIST)
- ④ - CONC PVMT (CONT REINF - CRCP) (8')
- ⑤ - 4" SUPERPAVE MIXTURES SP-B PG64-22
- ⑥ - 4" COMPOST MANUF TOP SOIL & SODDING
- ⑦ - CONC SIDEWALKS (4')
- ⑧ - CONC MEDIAN

NOTE:

- X-SLOPE CONTROLLED BY INTERSECTION CONTOURS
- @ "FM 1378" STA. 20+23.00 TO STA. 23+70.00
- @ "SOUTHVIEW1" STA. 109+19.00 TO STA. 110+81.49

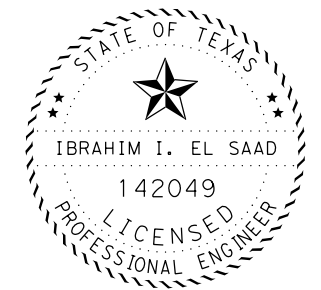

Ibrahim I. Saad, P.E. 2-9-23
 Signature of Registrant & Date



FM 1378
 AT FM 3286
**TYPICAL SECTIONS
 (PROPOSED)**

N. T. S.			SHEET 6 OF 8
DESIGN IIE	FED. RD. DIV. NO. 6	FEDERAL AID PROJECT NO. SEE TITLE SHEET	HIGHWAY NO. FM 1378, ETC.
GRAPHICS IIE	STATE TEXAS	DISTRICT DAL	COUNTY COLLIN
CHECK	CONTROL 1392	SECTION 01	JOB 044, ETC.
			9

DATE: 2/9/2023 TIME: 9:46:45 AM FILE: c:\txdot\pw\onl\ine\txdot5\ibrahim.e\saad\0467417\Proposed Typical Sections Sheets.dgn

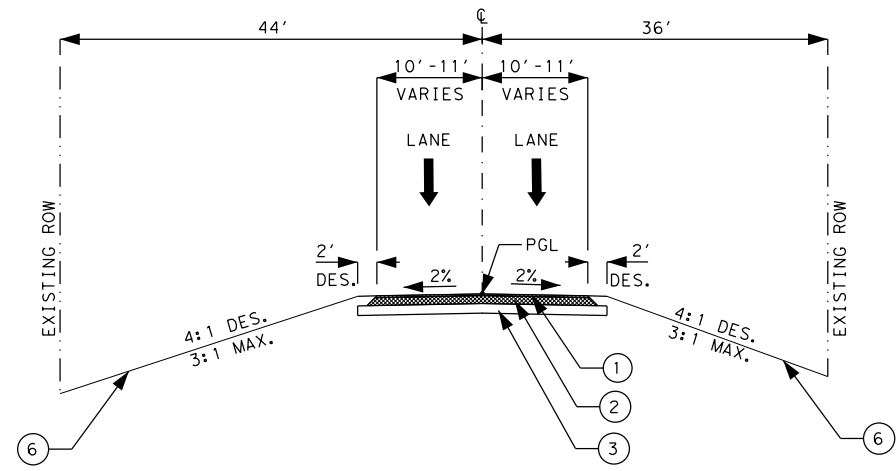

PROPOSED TYPICAL SECTION EDGEFIELD LN.
 CL "EDGEFD" STA. 10+16.50 TO STA. 10+37.45

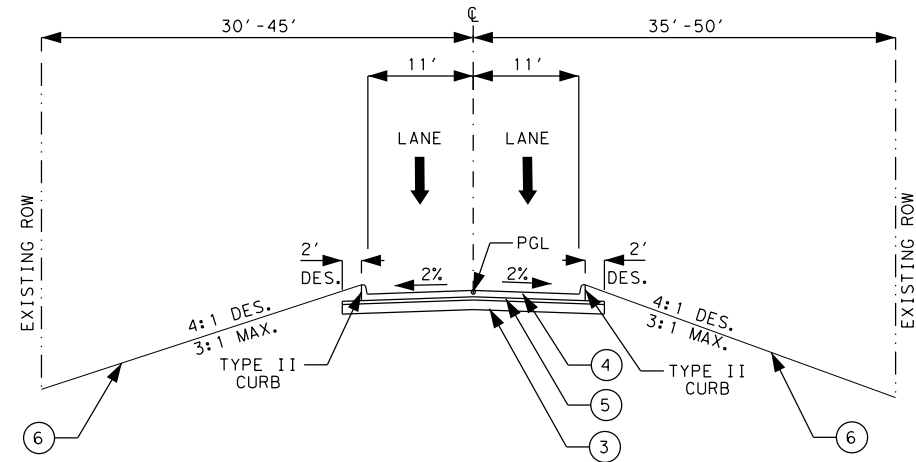

PROPOSED TYPICAL SECTION CEDAR BEND TRAIL
 CL "CEDARTR" STA. 10+55.90 TO STA. 10+86.76

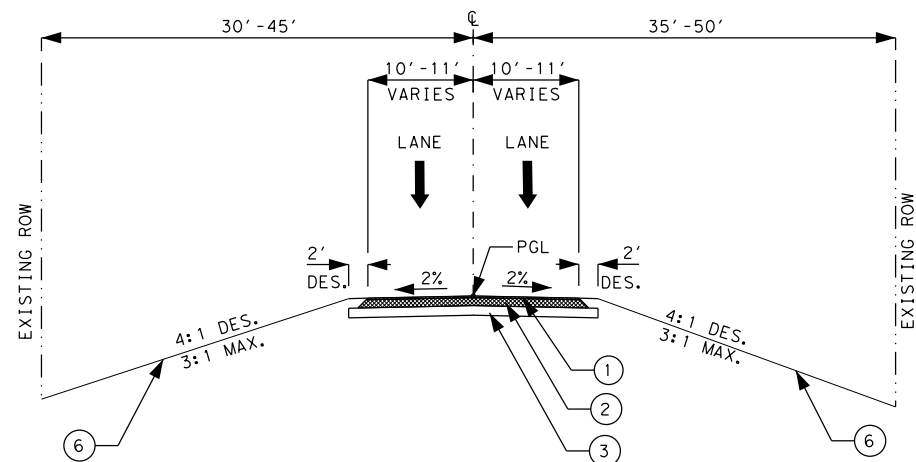

PROPOSED TYPICAL SECTION CEDAR BEND TRAIL
 CL "CEDARTR" STA. 10+86.76 TO STA. 11+77.04

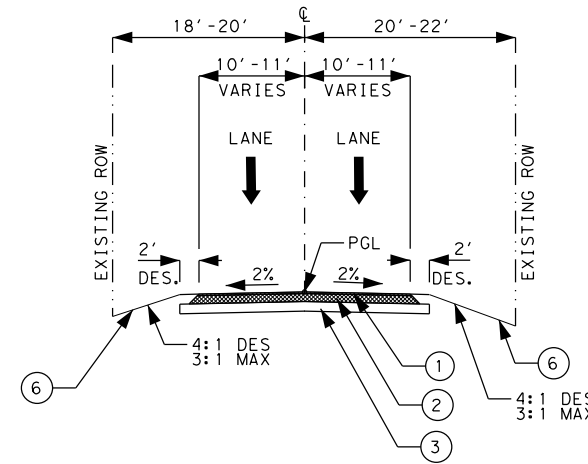

PROPOSED TYPICAL SECTION LOST VALLEY DR.
 CL "LOSTVD" STA. 10+42.73 TO STA. 11+01.77

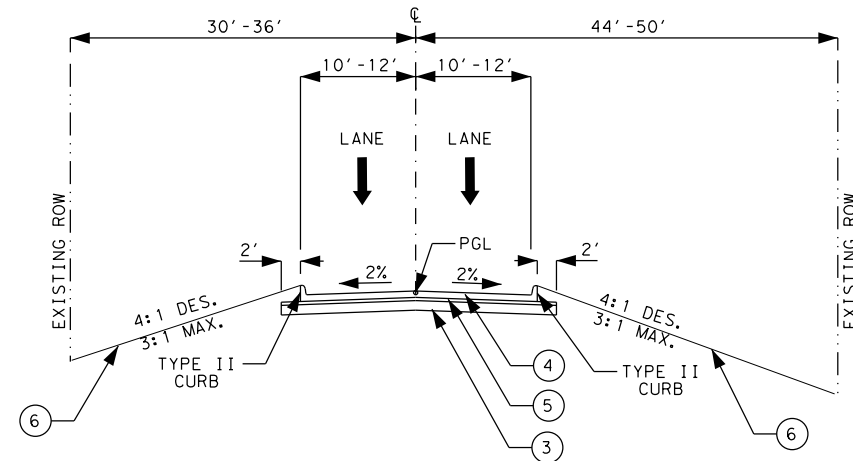

PROPOSED TYPICAL SECTION WINDING CREEK DR.
 CL "WINDCK" STA. 0+21.11 TO STA. 0+59.16

LEGEND

- ① - 2" SUPERPAVE MIXTURES SP-C PG64-22 SAC-B
- ② - 6" SUPERPAVE MIXTURES SP-B PG64-22
- ③ - 8" LTS WITH 5% LIME (EXIST)
- ④ - CONC PVMT (CONT REINF - CRCP) (8')
- ⑤ - 4" SUPERPAVE MIXTURES SP-B PG64-22
- ⑥ - 4" COMPOST MANUF TOP SOIL & SODDING
- ⑦ - CONC SIDEWALKS (4')
- ⑧ - CONC MEDIAN

NOTE:

- X-SLOPE CONTROLLED BY INTERSECTION CONTOURS
- CL "FM 1378" STA. 20+23.00 TO STA. 23+70.00
- CL "SOUTHVIEW1" STA. 109+19.00 TO STA. 110+81.49

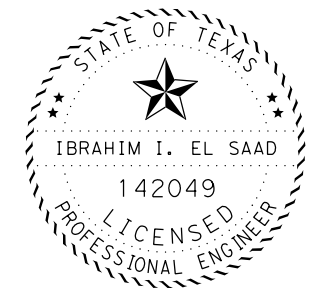

Ibrahim I. Saad, P.E. 2-9-23
 Signature of Registrant & Date



FM 1378
 AT FM 3286
**TYPICAL SECTIONS
 (PROPOSED)**

N. T. S.			SHEET 7 OF 8
DESIGN IIE	FED. RD. DIV. NO. 6	FEDERAL AID PROJECT NO. SEE TITLE SHEET	HIGHWAY NO. FM 1378, ETC.
GRAPHICS IIE	STATE TEXAS	DISTRICT DAL	COUNTY COLLIN
CHECK	CONTROL 1392	SECTION 01	JOB 044, ETC.
			10

DATE: 2/9/2023 TIME: 9:47:01 AM FILE: c:\txdot\pw\onl\ine\txdot5\ibrahim.e\saad\0467417\Proposed Typical Sections Sheets.dgn

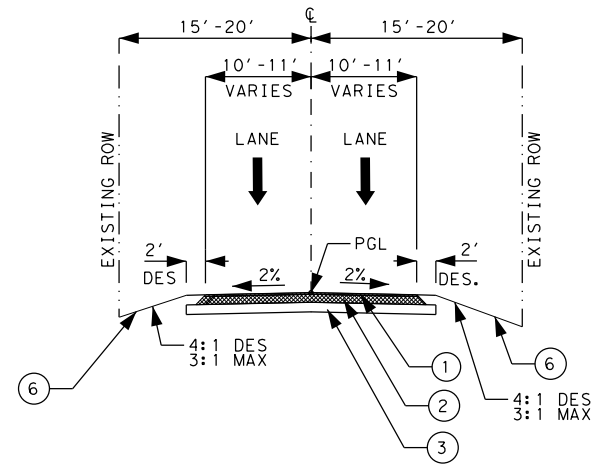

PROPOSED TYPICAL SECTION HOB HILL LN.
 @ "HOBLN" STA. 10+20.10 TO STA. 10+74.65

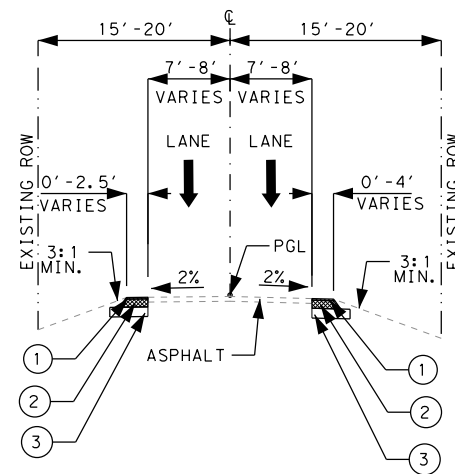

PROPOSED TYPICAL SECTION HOB HILL LN.
 @ "HOBLN" STA. 10+74.65 TO STA. 11+19.75

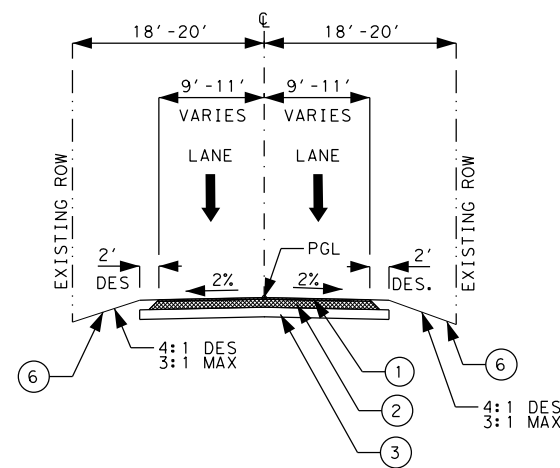

PROPOSED TYPICAL SECTION PRADO VERDE DR.
 @ "PRADO" STA. 10+26.62 TO STA. 10+72.76

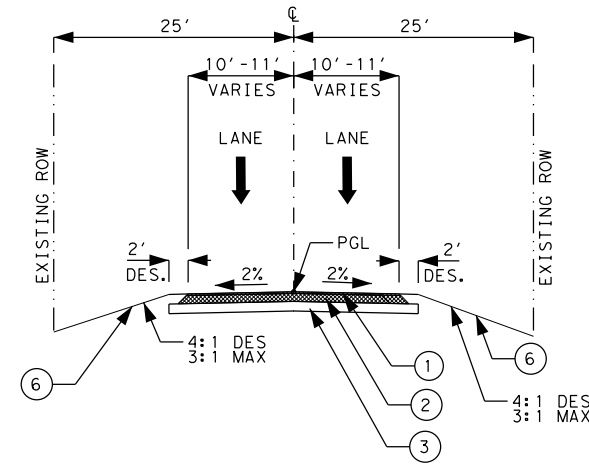

PROPOSED TYPICAL SECTION CAREY LN.
 @ "CAREYLN" STA. 10+23.52 TO STA. 10+52.00

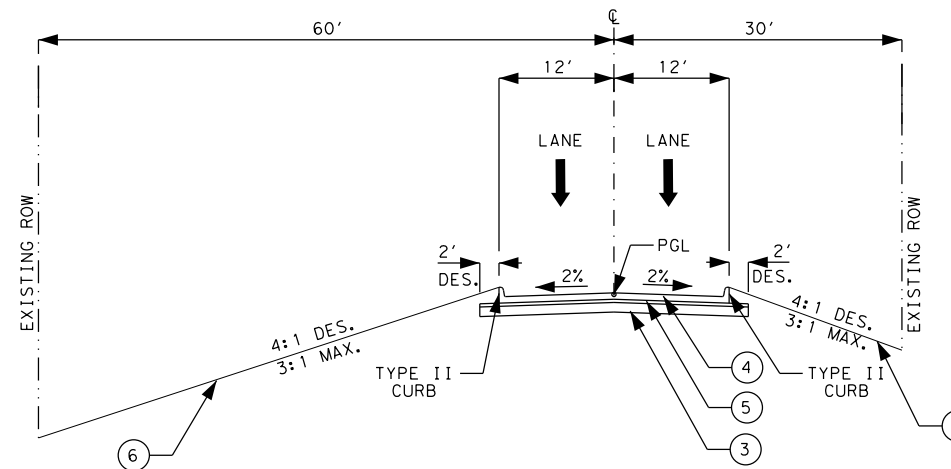

PROPOSED TYPICAL SECTION ARTHUR CT.
 @ "ARTHURCT" STA. 10+17.70 TO STA. 10+43.00

LEGEND

- ① - 2" SUPERPAVE MIXTURES SP-C PG64-22 SAC-B
- ② - 6" SUPERPAVE MIXTURES SP-B PG64-22
- ③ - 8" LTS WITH 5% LIME (EXIST)
- ④ - CONC PVMT (CONT REINF - CRCP) (8')
- ⑤ - 4" SUPERPAVE MIXTURES SP-B PG64-22
- ⑥ - 4" COMPOST MANUF TOP SOIL & SODDING
- ⑦ - CONC SIDEWALKS (4')
- ⑧ - CONC MEDIAN

NOTE:

- X-SLOPE CONTROLLED BY INTERSECTION CONTOURS
- ℄ "FM 1378" STA. 20+23.00 TO STA. 23+70.00
- ℄ "SOUTHVIEW1" STA. 109+19.00 TO STA. 110+81.49

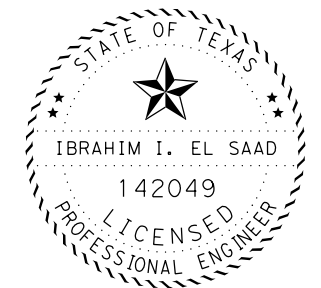

Ibrahim I. El Saad, P.E. 2-9-23
 Signature of Registrant & Date



FM 1378
 AT FM 3286
**TYPICAL SECTIONS
 (PROPOSED)**

N. T. S.			SHEET 8 OF 8
DESIGN IIE	FED. RD. DIV. NO. 6	FEDERAL AID PROJECT NO. SEE TITLE SHEET	HIGHWAY NO. FM 1378, ETC.
GRAPHICS IIE	STATE TEXAS	DISTRICT DAL	COUNTY COLLIN
CHECK	CONTROL	SECTION 01	JOB 044, ETC.
			11

SPECIFICATION DATA

SPECIFICATION DATA

Table 1: Soil Constants Requirements				
Item	Description	Plasticity Index		Note
		Max	Min	
132	EMBANKMENT (FINAL)(DC)(TY C1)	40	8	1

Note 1: Material excavated from the project must meet the PI requirements when used in the top 10 feet of embankment that supports the pavement structure or other locations shown in the plans. Do not use shale and obtain approval to incorporate shaley clay produced by the construction project.

Table 2: Basis of Estimate for Permanent Construction					
Item	Description	Thickness	Rate		Quantity
161	Compost Manufactured Topsoil	4"			36,897 SY
162	Block Sod	N/A	See Specifications		36,897 SY
166 *	Fertilizer (12-6-6)	N/A	500	Lbs./Ac	1.91 Ton
168	Vegetative Watering (Warm)**	N/A	12	MG/Ac/Day	5,489 MG
260	Hydrated Lime (slurry) OR Commercial Lime Slurry OR Quick Lime (slurry)			5% by wt.	695 Ton
3077	SP MIXES (SP-B)	See Plans	110	Lbs./SY/In	10,656 Ton
3077	SP MIXES (SP-C)	See Plans	110	Lbs./SY/In	1,702 Ton
3077	Tack Coat (Undiluted Application Rate)	New HMA	0.06	Gal/SY	1,850 Gal
*For contractor's information only					
**Use Summer rate for calculation, adjust for actual field conditions/temperatures as necessary. See Vegetation Establishment Plan Sheet for estimated daily rates.					
***Portland Concrete Cement					
Note: (1) Base material weight based on 1.50 Ton/CY (dry- compacted) (2) Asphalt weight based on 110 Lbs./SY/In (3) Subgrade weight based on 1.5 Ton/CY (dry-compacted)					

Table 3: Basis of Estimate for Temporary Erosion Control Items				
Item	Description	Rate		Quantity
164	Drill Seeding (Temp) (Warm or Cool)	See Specifications		10,654 SY
166*	Fertilizer (12-6-6)	500	Lb/Ac	0.55 Ton
168	Vegetative Watering (Warm)**	12	MG/Ac/Day	1,585 MG
*For Contractor's Information Only.				
**Use Summer rate for calculation, adjust for Actual Field Conditions/Temperatures as Necessary. See Vegetation Establishment Sheet for estimated daily rates.				

GENERAL

The construction, operation and maintenance of the proposed project will be consistent with the state implementation plan as prepared by the Texas Commission on Environmental Quality.

The disturbed area for this project, as shown on the plans is 16.9 acres. However, the Total Disturbed Area (TDA) will establish the required authorization for storm water discharges. The TDA of this project will be determined by the sum of the disturbed area in all project locations in the contract, and all disturbed area on all Project-Specific Locations (PSL) located in the project limits and/or within 1 mile of the project limits. The department will obtain an authorization to discharge storm water from the Texas Commission on Environmental Quality (TCEQ) for the construction site as shown on the plans, according to the TDA of the project. The contractor will obtain any required authorization from the TCEQ for the discharge of storm water from any PSL for construction support activities on or off of the project row according to the TDA of the project. When the TDA for the project exceeds 1 acre, provide a copy of the appropriate application of permit (NOI, or Construction Site Notice) to the engineer, for any PSL located in the project limits or within 1 mile of the project limits. Follow the directives and adhere to all requirements set forth in the TCEQ, Texas Pollution Discharge Elimination System, Construction General Permit (TPDES, CGP).

This project required permits with environmental resources agencies as outlined in the plan Environmental Permits, issues and Commitments (EPIC) Sheet. There is a high probability that an environmentally sensitive area could be encountered on the contractor designated Project-Specific Locations (PSL) for this project (haul roads, equipment staging areas, borrow pits, disposal sites, field offices, storage areas, parking areas, etc.). Item 7.6 "Project-Specific Locations", provides a listing of regulatory agencies that may need to be contacted regarding this project.

Install traffic marking signs prior to sealcoat application and remove within three days after placement of traffic markings.

County: Collin

Highway: FM 1378

Leave all right of way areas undisturbed until actual construction is to be performed in said areas.

The contractor must complete all work detailed in Phase 1 Stage 1-A prior to beginning the waterline relocations for NTMWD.

Questions may be submitted via the Letting Pre-Bid Q&A web page. This webpage can be accessed from the Notice to Contractors dashboard located at the following Address:

<https://tableau.txdot.gov/views/ProjectInformationDashboard/NoticetoContractors>

or Contractor questions on this project are to be addressed to the following individual(s):

AE Name Jennifer.Vorster@txdot.gov

AAE Name Gerald.Waltman@txdot.gov

Contractor questions will be accepted through email, phone, and in person by the above individuals.

All contractor questions will be reviewed by the Engineer. All questions and any corresponding responses that are generated will be posted through the same Letting Pre-Bid Q&A web page.

The Letting Pre-Bid Q&A web page for each project can be accessed by using the dashboard to navigate to the project you are interested in by scrolling or filtering the dashboard using the controls on the left. Hover over the blue hyperlink for the project you want to view the Q&A for and click on the link in the window that pops up.

Paper copies of cross-sections may be produced by using the provided .pdf file located on the above FTP Website at the bidders' expense and at copying companies. This data is for non-construction purposes only and it is the responsibility of the prospective bidder to validate the enclosed data with appropriate plans, specifications and estimate for the project(s).

Item 5:

Place survey monuments, provided by the department, at points indicated and as detailed in the plans or as directed. Furnish surface coordinates and the elevation of the set monument and an azimuth from the monument to some prominent physical feature, preferably another survey monument on the project. This work will not be paid for directly, but will be considered subsidiary to the various bid items.

Underground utilities owned by the Texas Department of Transportation may be present within the Right-Of-Way on this project. For signal, illumination, surveillance, and communications & control maintained by TxDOT, call the TxDOT Traffic Signal Office (214-320-6682) for locates a minimum of 48 hours in advance of excavation. For irrigation systems, call TxDOT Landscape Office (214-320-6205) for locates a minimum of 48 hours in advance of excavation. If city or town owned irrigation facilities are present, call the appropriate department of the local city or town a minimum of 48 hours in advance of excavation. The Contractor is liable for all damages when utilities are damaged due to Contractor's negligence including, but not limited to, repair or replacement at the Contractor's expense.

County: Collin

Highway: FM 1378

For the project to be deemed complete, permanently stabilize all unpaved disturbed areas of the project with a vegetative cover at a minimum of 70% density for the control of erosion.

Place construction stakes/station markings at intervals of no more than 100 feet or as directed by the Engineer. Place stakes and markings so as not to interfere with normal construction operations.

Submit all shop drawings, working drawings, or other documents which require review sufficiently in advance of scheduled construction to allow no less than thirty (30) calendar days for review and response.

When a precast or cast-in-place concrete element is included in the plans, a precast concrete alternate may be submitted in accordance with "Standard Operating Procedure for Alternate Precast Proposal Submission" found online at <https://www.txdot.gov/inside-txdot/forms-publications/consultants-contractors/publications/bridge.html#design>. Acceptance or denial of an alternate is at the sole discretion of the Engineer. Impacts to the project schedule and any additional costs resulting from the use of alternates are the sole responsibility of the Contractor.

Item 6:

To comply with the latest provisions of Build America, Buy America Act (BABA Act) of the Bipartisan Infrastructure Law, the contractor must submit a notarized original of the TxDOT Construction Material Buy America Certification Form for all items classified as construction materials. This form is not required for materials classified as a manufactured product.

Refer to the Buy America Material Classification Sheet for clarification on material categorization.

The Buy America Material Classification Sheet is located at the below link.

<https://www.txdot.gov/business/resources/materials/buy-america-material-classification-sheet.html> for clarification on material categorization.

Item 7:

Repair or replace any structures and utilities that might have been damaged by negligence or a failure to have utility locates performed.

Perform all electrical work in accordance with the National Electrical Code and Texas Department of Transportation Specifications.

Consult with appropriate electric company representatives according to their respective area to coordinate electrical services installations.

Holiday restrictions – The Engineer may decide that no lane closures or construction operations shall be allowed during the restricted periods listed in the following holiday schedule. TxDOT has the right to lengthen, shorten, or otherwise modify these restricted periods as actual, or expected, traffic conditions may warrant. Working days will not be charged for these restricted periods. No additional compensation will be allowed for these closures (i.e., overhead, delays, stand-by, barricades or any other associated cost impacts).

- New Year's Eve and Day (5 am on December 31 thru 10:00 pm January 1)

County: Collin

Highway: FM 1378

- Easter Holiday weekend (5 am on Friday thru 10:00 pm Sunday)
- Memorial Day weekend (5 am on Friday thru 10:00pm Monday)
- Independence Day (5 am on July 3 thru 10:00 pm on July 5)
- Labor Day weekend (5 am on Friday thru 10:00 pm Monday)
- Thanksgiving Holiday (5 am on Wednesday thru 10:00 pm Sunday)
- Christmas Holiday (5 am on December 23 thru 10:00 pm December 26)

No significant traffic generator events identified.

Item 8:

This Project will be a Six-Day Workweek in accordance with Article 8.3.1.2.

Nighttime work is allowed in accordance with Article 8.3.3.

Meet weekly with the engineer to notify him or her of planned work for the upcoming week.

Provide the engineer with a daily work schedule of planned work.

Critical Path Method (CPM) schedule in P6 format will be required for this project. Submit baseline schedule and obtain approval prior to beginning construction. The Estimate will be held if monthly schedule update is not submitted.

The contractor will be awarded an incentive as shown in Table 8-1, Special Provision 008-006, for each day of early completion of the milestone. Further, the contractor will be assessed a disincentive for failing to meet the milestone specified in Table 8-1.

Table 8-1

Milestone No.	Type	Milestone Description	Milestone Duration	Daily Incentive and Disincentive Rate
1	Incentive/ Disincentive	The milestone begins on the first day of the Phase 1 Stage 2 of the construction as shown in the traffic control plan sheets.	117 working Days	\$5,000 (maximum 22 working days for Incentive)

Item 100:

Remove the existing roadway small signs, delineators and object markers as shown on the plans, or as directed, during construction within the right of way. Small sign, delineator and object marker removals are subsidiary to this Item.

The limits of preparing right of way will be measured along the centerline of construction. See project layout sheet for limits.

Item 104:

In those areas where the pavement is not to be overlaid, provide a smooth surface after the curb removal. Planing or grinding is considered an acceptable method at these locations. Measurement and payment is in accordance with this item.

County: Collin

Highway: FM 1378

Sawing of concrete is not paid for directly, but is considered subsidiary to this item.

Item 105:

Saw existing asphalt along neat lines where portions are to be left in place temporarily or permanently. Sawing is not paid for directly, but is subsidiary to this item.

Take possession of recycled asphalt pavement from the project and recycle the material.

Properly dispose of unsalvageable material at your own expense.

Item 110:

Excavated shale is not an acceptable material for embankment.

Items 110 and 132:

Scarify and loosen the excavated areas, unpaved surface areas, except rock, to a depth of at least 8 inches and compact in accordance with the specifications.

Excavation and embankment for driveways, sleeper slabs, alleys and intersections will not be paid for directly, but will be considered subsidiary to these items.

Item 132:

Excavated material from the project site has not been determined to be suitable for embankment. The bidder assumes all risk for the use of excavated materials for embankment and is expected to meet all material requirements for embankment regardless of the source.

Perform Tex-106-E (Plasticity Index) by an approved laboratory on excavated soils from sources outside right of way when used in roadway embankment. Provide the test results at no expense to the department. The engineer will sample and test soils produced by the construction project for specification requirements or material sources specified in the plans.

Earth embankment Type C1, is mainly composed of material other than shale. Furnish material that is free from vegetation or other objectionable material and that conforms to the requirements of Table 1 (Sheet A). If necessary, treat material with lime slurry in accordance with Item 260, "Lime Treatment (Road-Mixed)" in order to meet these requirements. Use Tex-121-E, figure 1, page 4 to calculate the amount of lime required. When lime treated subgrade is specified, 3000 PPM is the maximum allowed sulfate content in the top 3 feet when material comes from borrow source. Follow recommendations of 260.4.4 for mixing and mellowing. The engineer will test material placed or excavated to a depth of one foot below and laterally to one foot outside the proposed treatment limit. Lime treatment of this material will not be paid for directly, but will be considered subsidiary to this item.

Do not use shaley clays in embankment unless approved in writing.

Item 160:

Sequence construction operations to salvage topsoil from one location and spread on areas ready to receive topsoil. Keep stockpiling of topsoil to a minimum.

County: Collin

Highway: FM 1378

Use fertile clay or loam from the project site not more than six inches below natural grade as topsoil.

Item 161:

Provide tickets representing quantity of compost delivered to site.

Item 260:

Furnish and distribute MS-2 smoothly and evenly at the rate of 0.20 gallons per square yard to cure lime, as directed.

Provide Commercial Lime Slurry and apply lime by slurry placement method.

Item 320:

Use a self-propelled wheel mounted MTV capable of receiving mix from the haul trucks, separate from the paver. It shall have a minimum storage capacity of approximately 25 tons. It shall be equipped with a pivoting discharge conveyor and shall completely and thoroughly remix the material prior to placement. The effectiveness of the MTV's remixing ability is subject to the approval of the Engineer. In addition, the paver shall have a surge storage insert with a minimum capacity of 20 tons.

The use of windrow pick-up equipment is allowed except on the first course of roadway material placed over the subgrade.

Item 360:

Use of multiple piece tiebars will be required. Provide chairs for multiple piece tiebars, threaded connectors or other adequate devices, used in concrete paving, or tie them to the pavement reinforcing steel. If approved by the engineer for specific areas, in lieu of multiple piece tiebars, drill holes into the pavement and grout straight tiebars in place with epoxy. Use a non-impact, rotary core drill to prevent damage to the pavement unless otherwise directed. Clean the drill holes and then completely fill with epoxy before inserting the tiebar. Do not bend the tiebars or insert them into plastic concrete without the approval of the engineer.

Provide curbs monolithically constructed with the concrete pavement. If continuous monolithic curb has to be temporarily omitted for any reason, provide dowelled curbs in the proposed areas, as detailed in the plans, and apply an approved epoxy resin to the pavement to receive the curb as directed. This work and materials will not be paid for directly, but is considered subsidiary to this item.

If asphalt curing is used, cure the concrete pavement with MS-2.

Stockpile the concrete aggregates at the plant site.

Provide pavement widening joints, as detailed in the plans, at all locations where concrete pavement is placed adjacent to existing concrete pavement. Installation of these joints is not paid for directly, but is considered subsidiary to this item.

Payment for furnishing and installing the pre-molded expansion joint material between the retaining walls and concrete pavement is not paid for directly, but is considered subsidiary to this item.

County: Collin

Highway: FM 1378

Provide a curing machine equipped with rubber tires, or other acceptable arrangement, so that the machine will span the pavement and monolithic curb.

Curb transition is paid for as Type II curb.

The installation of curb openings is not paid for directly, but is considered subsidiary to this item.

Place construction, sawed and contraction joints in accordance with the pavement detail sheet and as directed. Joint locations, other than as shown on the plans, are subject to approval.

Pavement leave outs are required on this project as necessary to provide for traffic at driveways and side streets as shown in the plans or as directed. The cost of providing these leaveouts, including the construction of a suitable crossover connection at each site, is not paid for directly but is considered subsidiary to this item.

If a traveling form paver is used, provide one equipped with an electronically operated horizontal control device.

Use "mechanical steel placing equipment" at the discretion of the engineer.

Supply the Engineer with a list of certified personnel and copies of their current ACI certificates before beginning production and when personnel changes are made. Supply hard copies of calibration reports for testing equipment when required by the Engineer.

If more than 30% of an area in any 1000-Ft section of roadway requires grinding, action will be taken by the Contractor to make that 1000-Ft full width section uniform without changing ride quality, compromising quality of pavement and decreasing skid resistance. Approved blasting method or other method approved by the Engineer will be performed at the Contractor's expense.

Item 400:

Structural Excavation is not paid for directly but is considered subsidiary to pertinent Items.

When placing concrete storm drain pipe on slopes of greater than 10 percent, provide cement stabilized backfill to a depth shown on the plans.

Item 416:

Drilled shafts shall be drilled and poured on the same day unless directed by the engineer.

Provide a formed smooth finish for all portions of drill shafts extending above proposed ground. Include cost for this work in the unit bid price for this item.

Traffic signal and luminaire pole foundations will be paid for once regardless of extra work caused by obstructions.

County: Collin

Highway: FM 1378

Concrete removal required for installation of drilled shafts will be subsidiary to Item 416.

Item 421:

Furnish mix designs to the Engineer in a format compatible to the latest version of the Department's Construction Management System (SiteManager). Mix Design templates will be provided by the Engineer.

Provide sulfate resistant concrete for all drilled shafts.

Item 440:

All ties, chairs and other appurtenances used with epoxy coated reinforcing shall be epoxy coated or non-metallic.

Fiber Reinforced Concrete (FRC) can be used as a substitute for Non-Structural Class Reinforced Concrete in Mow-Strip and Rip Rap Items as approved. FRC may also be used for other Non-Structural Class Reinforced Concrete Items as approved.

Item 449:

Use Thomas & Betts Kopr-Shield, MG Chemicals #846, MG Chemicals #8463, NYOGEL #756G, Pro-Shield #7308, Cho-Lube #4220, or other approved electrically conducting lubricant compound.

Item 464:

The concrete collars and the connections of pipes to existing or proposed concrete boxes or pipe will not be paid for directly but will be considered subsidiary to the various bid items.

At locations where storm drains dead-end, plug with a concrete plug of a thickness equal to 1 1/2 inches per foot of diameter of pipe with a minimum thickness of 3 inches. The cost of the plugs shall be included in the unit price bid per foot of the various storm drain pipes.

Item 465:

All manholes, junction boxes and inlets will require inverts unless otherwise directed.

Item 471:

Tackweld all inlet grates and manhole covers to the frame with two 1-inch welds. Supply unpainted cast iron inlet grate and frame and/or cast iron manhole frame and cover.

Item 496:

Concrete pavement removed as a result of removing the inlets will not be paid for directly but will be considered as subsidiary to Item 496.

Inlet grates and manhole covers become the property of the contractor for disposal.

Item 500:

Material On Hand (MOH) will not be used in calculating partial payments for Mobilization.

County: Collin

Highway: FM 1378

Item 502:

The Contractor Force Account "Safety Contingency" that has been established for this project is intended to be utilized for work zone enhancements, to improve the effectiveness of the Traffic Control Plan, that could not be foreseen in the project planning and design stage. These enhancements will be mutually agreed upon by the Engineer and the Contractor's Responsible Person based on weekly or more frequent traffic management reviews on the project. The Engineer may choose to use existing bid items if it does not slow the implementation of enhancement.

Access will be provided to all business and residences at all times. Where turning radii are limited during phased construction at intersections, provide all weather surfaces such as RAP or base in turning movements to accommodate and to protect the traffic from edge drop-offs. Materials, labor, maintenance and removal for these temporary accesses and radii will not be paid for directly but will be considered subsidiary to the various bid items.

Provide written proposed lane closure information by 1:00 pm on the business day prior to the proposed closures. Do not close lanes when this requirement is not met.

When excavation is required next to a pavement lane carrying traffic and the widening is not completed by the end of the work day, backfill against the edge of the pavement with at least a 3:1 slope using an acceptable material to support vehicular traffic. Carefully remove and dispose of this material when work resumes. Backfilling pavement edges, and the materials required for the work will be subsidiary to this item.

Place barricades and signs in locations that do not obstruct the sight distance of drivers entering the highway from driveways or side streets.

Provide rectangular shape (CW12-2P) Temporary Clearance Signs on all bridges where the existing vertical clearance has changed. Install Signs to the satisfaction of the Engineer prior to opening to traffic. Plywood sign blanks will have minimum dimensions of 84" X 12". Work performed and materials are subsidiary to this item.

When moving unlicensed equipment on or across any pavement or public highways, protect the pavement from all damage using an acceptable method.

As approved by the Engineer, provide uniformed off duty police officers and squad cars during lane or ramp closures, night time work or other situations that indicate a need for additional traffic control to protect the traveling public or the construction workforce. Provide documentation such as payroll, log sheets with signatures and badge number, or invoices from the government entity providing the officers for reimbursement. Complete the weekly tracking form provided by the department and submit invoices that agree with the tracking form for payment at the end of each month approved services were provided. Reimbursement will not be made for coordination fees charged by any party.

Item 506:

Take all practicable precautions to prevent debris from being discharged into the Waters of Texas or a designated wetland. Install Best Management Practices before demolition begins and maintain them during the demolition. Remove any debris or construction material that

County: Collin

Highway: FM 1378

escapes containment devices and are discharged into the restricted areas, before the next rain event or within 24 hours of the discharge.

If temporary construction stream crossings are allowed under a Nationwide Permit, submit in writing for approval the type and location of each temporary stream crossing. Use temporary bridges, timber mats, or other structurally sound and non-eroding material for temporary stream crossings. A temporary culvert crossing will consist of storm sewer pipes and 4- to 8-inch nominal size rock. Temporary stream crossings must not cause more than minimal changes to the hydraulic flow characteristics of the stream, increase flooding, or cause more than minimal degradation of water quality. Remove the temporary stream crossings in their entirety and return the affected areas to their pre-existing elevation. All work and materials use for temporary construction stream crossings will not be paid for directly but are subsidiary to pertinent Items.

Provide SW3P Signs. Obtain from the Engineer a copy of the project's completed TPDES Storm Water Program Construction Site Notice and Contractor Site Notice. Laminate the sheets and bond with adhesive to 36" X 36" plywood sign blanks. Ensure the sheets remain dry. Apply Type C Blue reflective sheeting as the background and add the text "SW3P" in 5" white lettering, centered at the top. Attach the signs to approved temporary mounts and locate at each of the project limits just inside the right of way line at a readable height or as directed by the Engineer. If the sign cannot be placed outside the clear zone, it must adhere to the TMUTCD. SW3P signs, maintenance, and reposting (for replacement or as needed to ensure readability) will be subsidiary to Item 502.

Concrete Washouts are required per the CGP. The Concrete Washout Area(s) structural controls must consist of temporary berms, temporary shallow pits, and/or temporary storage tanks to prevent contaminated runoff and must be lined as to prevent contamination of underlying soil. Ensure pits properly maintained including removal of concrete as not to allow over flow. The location(s) of washout area will be approved by the Engineer. When washout pits are no longer needed, they will be removed and area will be restored to original condition. This work, materials and labor will not be measured or paid for directly but will be subsidiary to Item 506, "Temporary Erosion, Sedimentation, and Environmental Controls."

Item 508:

Testing of materials used in the construction of a temporary detour may be waived when approved by the Engineer.

Item 512:

The contractor will furnish pre-cast F Shape Barriers for traffic control, and remove and retain possession of non-permanent barriers at the end of the project. Pre-cast F Shape Barriers must have drainage slots as detailed on the Concrete Safety Barrier Standards. Submit for approval the type of barrier joint connection proposed for the project.

Item 529:

Provide grooved joints at 10-foot intervals and $\frac{3}{4}$ inch expansion joint material for doweled curb at the same locations as on the existing pavement. For Curb and Gutter sections, provide grooved joints at 10-foot intervals and $\frac{3}{4}$ inch expansion joint material at a maximum of 50-foot centers and at all radius points and inlets.

County: Collin

Highway: FM 1378

Curb and Gutter transitions will be paid for by the foot at the unit price for the corresponding curb or curb and gutter section.

Saw joints at the same location as on the existing pavement.

Item 531:

Joint sealant is required when shown in the plans. This work will not be paid for directly but will be considered subsidiary to this Item.

Item 536:

Use Class "B" concrete for concrete medians and directional islands.

Item 540:

Furnish one type of post throughout the project except as specifically noted in the plans.

Item 585:

Use Surface Test Type A on all intersections and driveways.

Use Surface Test Type B pay adjustment schedule 2 on the travel lanes.

Item 610:

Use 240 volt electronic LED drivers for luminaires on this project.

Provide 12 circuit Buchanan Type 112SN, Kulka Type 985-GP-10 CU, or equal terminal strip in the luminaire pole access compartment. The conductors for the line and load side of the terminal strip shall be identified with a plastic label with two straps per tag. The load side shall have each signal head and ped head identified on the tag.

Item 618:

The location of conduits and ground boxes are diagrammatic only and may be shifted to accommodate field conditions as directed.

Secure permission and approval from the proper authority prior to cutting into or removing any sidewalks or curbs for installation of this Item.

Place conduit under existing pavement by an approved boring method. Do not place boring pits closer than 2 feet from the edge of the pavement unless otherwise directed. Do not use water jetting. When conduits are bored, do not exceed 18 inches in the vertical and horizontal tolerances as measured from the intended target point.

Do not use a pneumatically driven device for punching holes beneath the pavement (commonly known as a "missile").

Furnish and install a non-metallic mule tape in conduit runs in excess of 50 feet. Also furnish and install non-metallic mule tape in conduit installed for future use and cap using standard weather-tight conduit caps, as approved. Furnish Garvin # PT-1250-3K, ComStar PUL

County: Collin

Highway: FM 1378

1250P3K, Ideal Part No. 31-315 or equal as approved by the Engineer. This work will not be paid for directly, but is subsidiary to this Item.

Use a colored cleaner-primer on all PVC to PVC joints before application of PVC cement.

Seal all conduit ends with a permanently soft, non-toxic duct seal. Use a duct seal that does not adversely affect other plastic materials or corrode metals.

2" Schedule 80 PVC will be used at the power pole to supply electricity to underground services.

Item 620:

The equipment grounding conductor shall be identified by a continuous green colored jacket insulation or bare wire. Grounded conductors (Neutral) shall be identified by a continuous white colored jacket. Ungrounded conductors (Hot) in a 120/240v system shall be identified by each pole or leg. For 240-volt branch circuit fed from 120/240 source, ensure one leg is identified by a continuous black colored jacket and the other leg by a continuous red colored jacket.

For both transformer and shoe-base type illumination poles, provide double-pole breakaway fuse holder as shown on the Texas Department of Transportation (TxDOT) - Construction Division's (CST) materials producers list. Category is "Roadway Illumination and Electrical Supplies." Fuse holder is shown on list under Items 610 & 620. Provide 10 amp time delay fuses.

Item 624:

Slack conductors required by Standard Sheet ED(3)-14 will be subsidiary to Item 624.

Concrete removal required for installation of ground boxes will be subsidiary to Item 624.

Item 627:

Use the timber pole heights, as shown on the plans and in the material summary, for bidding purposes only. Coordinate pole locations, and make field measurements before construction to ensure a vertical clearance of 17 to 19 feet from the highest point on the roadway surface to the span. Except for supplemental nearside signal heads, all signal heads must be installed at least 40' from the stop line. If field adjustments result in the nearest signal head being more than 180' from the stop line, install a supplemental nearside signal head as directed by the engineer. Determine the field measurements and elevations from the actual field location of the poles, considering all above and below ground utilities and existing roadway elevations.

Item 628:

Contact the appropriate utility company during the first three weeks of the project lead-time period to allow adequate time for any necessary utility adjustments, transformer installation, etc.

The Meter Base shall be mounted facing the roadway and the service enclosure shall be mounted on the opposite side of the service pole or pedestal.

The Contractor shall obtain the street address of the new electrical service directly from the applicable City.

County: Collin

Highway: FM 1378

Label the service enclosures indicating service address as well as all required information as shown on the Electrical Detail (ED) standard sheets. Labeling shall be silk screening or other acceptable method. This work will not be paid for directly, but is subsidiary to this Item.

A Licensed Master Electrician shall oversee the installation of all electrical services.

Bill the electrical service power usage to the Texas Department of Transportation.

On the outside lower front of each electrical service meter base cover, install a 12 gauge minimum thickness stainless steel, aluminum or brass placard. The placard shall be engraved or stamped with the numeric portion of the street address and permanently affixed to the cover with exterior rated adhesive so as not to interfere with the operation of the latch. This work will not be paid for directly, but is subsidiary to this Item.

Items 644:

Provide two (2) sets of shop drawings for signs. The shop drawings shall conform to the details shown on the plans. The shop drawings shall show the details of the panels, wind beams, stiffeners, joint backing plates, splices, fasteners, brackets, and sign support connections. The shop drawings shall show letter types and sizes, interline spacing and message arrangements.

Affix a sign identification decal to the back of all signs in accordance with Item 643.

Prior to taking elevations to determine lengths for fabrication of sign posts and/or sign support towers, obtain verification of all proposed locations.

All sign mounts shall have a clamp base system for all small roadside sign assemblies.

Item 656:

Form a 3/4-inch chamfer on the top edge of each pedestal pole foundation.

Probe for utilities and underground structures prior to drilling foundations. Foundations shall be paid for once regardless of extra work caused by obstructions.

Item 677:

A water blasting method approved by the Engineer will be the only method allowed for the removal of permanent and temporary pavement markings except on a sealcoat surface. A 2 foot wide sealcoat will be required on sealcoat surfaces to eliminate permanent and temporary pavement markings.

Item 680:

Requirements for this Item include the following work, all of which are subsidiary to this Item:

1. Notify the Traffic Projects Office at DAL_TPO@txdot.gov one week before beginning any work involving traffic signals. Supplement email correspondence with the District Signal Maintenance Office at (214)320-6682 and Construction Office at (214)319-6406.
2. Provide submittal literature for all traffic signal equipment before installation.

County: Collin

Highway: FM 1378

3. Furnish and install a new controller (eight phase NEMA TS 2 Type 1) and cabinet (NEMA TS 2 Size 6, 16 position load bay), meeting the requirements of Departmental Materials Specifications DMS-11170. Provide detector panel toggle switches that additionally permit the user to disconnect the detector. Provide new MMU with Ethernet port.
4. Deliver the cabinet, controller, and accessories (with all cabinet components completely connected and securely strapped down) to the District Signal Shop, 4777 E Hwy 80, Mesquite, for testing. Notify the District Signal Shop two working days before delivery at (214)320-6682.
5. Install the controller cabinet in an orientation as directed.
6. Connect all field wiring to the controller assembly. The District will assist in determining how the detection cables are to be connected, and will also program the controller for operation, hook up the malfunction management unit (MMU) or conflict monitor, detector units, and other equipment, and turn on the controller. Pick up the signal cabinet from the District Signal Shop. Have a qualified technician and a representative from the controller supplier on the project site to place the traffic signals in operation.
7. Furnish and install all sign panels (except street name signs) for mounting on signal poles and mast arms. Fabricate the sign panels in accordance with Item 636. Install the sign panels supplied for mounting on mast arms, and span wires. Furnish all mounting hardware for all signs. Mount signs with Astro-Sign Brac, Signfix aluminum channel, or equal as approved by the Engineer.
8. Provide 250W Equivalent LED Fixtures with 240 volt electronic LED drivers as shown on the Material Producers List.
9. Install the emergency vehicle preemption equipment supplied by the City of Lucas.
10. Use qualified personnel to respond to and diagnose all trouble calls during the thirty-day test period. Repair any malfunction to Contractor-supplied signal equipment. Provide to the Engineer a local telephone number, not subject to frequent changes and available on a 24-hour basis, for reporting trouble calls. Response time to reported calls must be less than 2 hours. Make appropriate repairs within 24 hours. Place a logbook in the controller cabinet and keep a record of each trouble call reported. Notify the Engineer of each trouble call. Do not clear the error log in the conflict monitor or MMU during the thirty-day test period without approval.
11. Prevent any damage to property owner's poles, fences, shrubs, mailboxes, etc. Protect all underground and overhead utilities and repair any damage. Provide access to all driveways during construction.
12. Integrate the proposed traffic signal(s) into the existing closed loop system as shown on the plans. -CENTRACS closed loop software, which utilizes Econolite Cobalt controllers, is currently in use in the Dallas District. Provide controllers on this project that fully communicate with the existing closed loop system.
13. The concrete foundation for the controller as shown on TS-CF is diagrammatic and the dimensions will be adjusted in the field to fit existing conditions.
14. Salvage the existing traffic signal at FM 1378 & FM 3286 as shown on the plans. Salvage signal poles, luminaire pole, cabinet and controller, signal heads, luminaires, VIVDS cameras, radar units, granite service pole and equipment, exposed conduit, and any other equipment as directed. This equipment remains the property of the Texas Department of Transportation. The material listed above is to be stockpiled at the TxDOT District Signal Shop, 4777 E Hwy 80, Building N, Mesquite, Tx 75150 as directed. Contact the District Signal Shop at 214-320-6682 48 hours in advance of delivery. All other material removed in this project will become the property of the Contractor. Dispose of material off the right of

County: Collin

Highway: FM 1378

- way in accordance with federal, state, and local regulations. Maintain the operation of the existing traffic signal until directed to remove it.
15. Completely remove timber poles not set in concrete without cutting off the pole. Timber poles set in concrete are considered unsalvageable.

Item 681:

Requirements for this Item include the following work, all of which are subsidiary to this Item:

1. Re-guy signal heads and re-strap the cable after making adjustments to head locations. Accomplish relocation of signal heads for a phase change during the same day.
2. Bottom tether cable for signal heads and signs will be required.
3. Provide submittal literature for all traffic signal equipment before installation.
4. Furnish and install a controller (eight phase NEMA TS 2 Type 1) and cabinet (NEMA TS 2 Size 6, 16 position load bay), meeting the requirements of Departmental Materials Specifications DMS-11170. Provide detector panel toggle switches that additionally permit the user to disconnect the detector. Provide a pole-mounted cabinet that has three brackets for pole mounting and install a 5' x 5' x 4" Class A concrete pad under the cabinet in accordance to Items 420 and 421.
5. Operate and maintain the temporary signal. Provide a telephone number to the District for trouble calls. Check the signal equipment at least monthly, and within 24 hours in response to complaints, and immediately repair or replace any malfunctioning Contractor-supplied equipment. Notify the Department immediately upon finding malfunctioning Department-supplied equipment or a problem with the signal timing. Provide a reliable technical support person and phone number for the manufacturer of the controller.
6. Integrate the proposed traffic signal into the existing closed loop system as shown on the plans. CENTRACS closed loop software, which utilizes Econolite Cobalt controllers, is currently in use in the Dallas District. Provide controllers on this project that fully communicate with the existing closed loop system.
7. Relocate existing emergency vehicle preemption equipment to temporary signals.
8. Install pole-mounted BBU on the opposite side of the pole from the controller cabinet.

Item 682:

Install signal head attachments so that the wiring to each signal head passes from the mast arm through the attachment hardware to the signal head. Do not leave cable or wiring exposed.

Provide signal head attachments that allow for adjustment about the horizontal and vertical axis.

Provide aluminum pedestrian and vehicle signal heads in the following color: Federal Yellow #13538 of Federal Standard 595. Provide non-painted aluminum tubing. Provide back plates and the inside of visors with a flat black finish. Provide aluminum vented back plates for all traffic signal heads.

Turn down signal heads or cover with burlap or other material, as approved, until traffic signal is placed in operation.

Mount signal heads level and plumb and aim as directed.

County: Collin

Highway: FM 1378

Item 684:

Provide stranded 14 AWG Type A signal cables for LED signal heads and stranded 12 AWG Type C cables for APS units.

Provide a separate multi-conductor signal cable (14 AWG) inside pedestal poles and signal poles from the terminal strip to each signal head as shown on the plans.

Identify each cable as shown on the plans (cable 1, etc.) with permanent marking labels (Panduit Type PLM standard single marker tie, Thomas&Betts Type 548M, or equal) at each ground box, pole base, and controller.

Item 686:

Provide 12 circuit Buchanan Type 112SN, Kulka Type 985-GP-12 CU, or equal terminal strips in the signal pole access compartment. Provide additional terminal strips of 8 circuits each when more than 12 circuits are required. The conductors for the line and load side of the terminal strip shall be identified with a plastic label with two straps per tag. The load side shall have each signal head and ped head identified on the tag.

Mark pole shafts and mast arms with the identification numbers from the plans to facilitate field-assembly. Identify pole shafts and mast arms by intersection for projects with multiple intersections.

Provide nuts on top and bottom (double nuts) of the base plate as shown on the plans. Set anchor bolts for mast arm signal poles and strain poles so that two are in tension and two are in compression. Obtain approval of anchor bolt placement before placing concrete.

Provide vertical clearance of 17 to 19 feet from the roadway to the lowest point of the signal head or mast arm. Except for supplemental nearside signal heads, all signal heads must be installed at least 40' from the stop line. If field adjustments result in the nearest signal head being more than 180' from the stop line, install a supplemental nearside signal head as directed by the engineer. Determine the field measurements and elevations from the actual field location of the poles, considering all above and below ground utilities and existing roadway elevations.

Provide vibration dampers for mast arms 28 feet to 48 feet in length. Install as shown on MA-DPD.

Item 688:

Verify the location of the APS units and the direction of the arrows on the signs prior to installation.

Contractor shall provide a digital copy of the APS messages to TxDOT for all new APS Units on the project.

APS Units shall operate with hardwired connections for the communications path between the APS Units and the APS controller.

County: Collin

Highway: FM 1378

Item 730:

At the discretion of the Engineer, mow non-paved areas within the project prior to placement of permanent vegetation. Mow up to three (2) cycles per growing season.

Item 3077:

Use aggregate that meets the Surface Aggregate Classification (SAC) requirement of Class B.

Superpave Mixtures used as concrete pavement underlayment is deemed as "Exempt Production".

Provide PG binder 64-22 in Type SP-B mixture & SP-C mixture.

Item 6058:

The BBU will be installed with the controller on the concrete pad paid for under Item 680. If a larger pad is needed to accommodate the BBU, the additional labor and material will be subsidiary to this item.

Item 6292:

All additional items such as poles, conduit, cable, etc. required to achieve the detection specified in the plans will not be paid for separately, but will be considered subsidiary to this item.

Item 6306:

Install the Video Processor System so that it interfaces with the traffic controller unit (CU) via the detector rack. If the manufacturer does not have a product to interface via the detector rack, interface via SDLC.

If the camera locations shown in the plans do not allow for proper sight of the proposed detection zones, relocate the cameras as needed and as directed. This labor and material cost will not be paid separately, but is subsidiary to this item.

For temporary signals, the Contractor shall retain all removed VIVDS components furnished and installed as part of this project, unless otherwise shown on the plans.

The list of material below is for the Contractor's information only.
It is the responsibility of the Contractor to verify all items and quantities listed below.

LIST OF MATERIAL/LABOR
SUBSIDIARY TO ITEM 680

DESCRIPTION	UNIT	QUANTITY
250W EQ LED LUMINAIRE	EA	3
8 PHASE NEMA CONTROLLER COMPLETE W/ CABINET AND ACCESSORIES	EA	1

TRAFFIC SIGNAL CONTROLLER BASE	EA	1
INSTALL OPTICOM EQUIPMENT (INTERSECTION)	LS	1
RELOCATE STREET NAME SIGNS	EA	3
CONCRETE FOUNDATION (8' X 9' X 6", CLASS B)	CY	1.3

LIST OF MATERIAL/LABOR
SUBSIDIARY TO ITEM 681

DESCRIPTION	UNIT	QUANTITY
8 FT LUMINAIRE ARM FOR WOOD POLE MOUNTING W/250 W HPS EQ LED LUMINAIRE	EA	4
40 FT TIMBER POLE (CL 2))(INSTALL)	EA	4
3/8" ZINC-COATED STRANDED STEEL CABLE (INSTALL)	LF	1366
1/4" ZINC-COATED STRANDED STEEL CABLE (INSTALL)	LF	455
GROUND ANCHORS	EA	6
DOUBLE ANCHORS	EA	6
CABLE STRAPS	EA	455
YELLOW PLASTIC GUY GUARD	EA	12
8 PHASE NEMA POLE MOUNTED CONTROLLER COMPLETE W/CABINET AND ACCESSORIES	EA	1
INSTALL SINGLE STREET NAME SIGN PANEL	EA	3
CONCRETE FOUNDATION (5'X5'X4", CLASS A)	SF	25
BBU (POLE MOUNTED)	EA	1
RELOCATE REGULATORY SIGN PANEL (R10-12)	EA	1
2" WEATHERHEAD	EA	10

4" WEATHERHEAD	EA	1
CONDUIT RM (2")	LF	105
CONDUIT RM (4")	LF	20
CONDUIT (PVC) (SCHD 80)(2")	LF	14
ELEC CONDR (NO.6) BARE	LF	19
ELEC CONDR (NO.8) INSULATED	LF	1260
ELEC CONDR (NO.6) INSULATED	LF	38
VEH SIG SEC (12 IN) LED (GRN)	EA	6
VEH SIG SEC (12 IN) LED (GRN ARW)	EA	1
VEH SIG SEC (12 IN) LED (YEL)	EA	6
VEH SIG SEC (12 IN) LED (YEL ARW)	EA	1
VEH SIG SEC (12 IN) LED (RED)	EA	6
BACK PLATE (12 IN) (3 SEC) (VENTED) ALUM	EA	5
BACK PLATE (12 IN) (5 SEC) (VENTED) ALUM	EA	1
TRF SIG CBL (TY A) (14 AWG) (5 CONDR)	LF	840
TRF SIG CBL (TY A) (14 AWG) (7 CONDR)	LF	356

LIST OF MATERIAL
FURNISHED BY THE CITY OF LUCAS

DESCRIPTION	UNIT	QUANTITY
STREET NAME SIGNS	EA	3
OPTICOM CABLE	LF	838
OPTICOM DETECTOR W/MOUNTING BRACKET	EA	3
OPTICOM MODULES (2-CHANNEL)	EA	2

County: Collin

County: Collin

Highway: FM 1378

Highway: FM 1378

OPTICOM CARD RACK AND HARNESS	EA	1
OPTICOM CONTROLLER ASSEMBLY COMPLETE WITH CABINET AND ACCESSORIES	EA	1

Item 6185:

The total number of truck mounted attenuators (TMAs) or trailer attenuators (TAs) required when utilizing the traffic control standards are shown in the tables below.

TCP 2 Series	Scenario	Required TMA/TA	
(2-1)-18 / (2-2)-18 / (2-4)-18 / (2-5)-18 / (2-6)-18	All	1	
(2-3)-18	A B	1	2

TCP 3 Series	Scenario	Required TMA/TA
(3-1)-13	All	2
(3-2)-13	All	3
(3-3)-14	A B D	2
	C	3

The contractor will be responsible for determining if one or more of these operations will be ongoing at the same time to determine the total number of TMAs/TAs needed for the project. Additional TMAs/TAs used that are not specified in the plans in which the contractor expects compensation will require prior approval from the Engineer.



Estimate & Quantity Sheet

CONTROLLING PROJECT ID 1392-01-044

DISTRICT Dallas
HIGHWAY FM 1378, FM 3286

COUNTY Collin

CONTROL SECTION JOB				1392-01-044		1392-01-049		3476-02-013		TOTAL EST.	TOTAL FINAL
PROJECT ID				A00061976		R00005873		A00176186			
COUNTY				Collin		Collin		Collin			
HIGHWAY				FM 1378				FM 3286			
ALT	BID CODE	DESCRIPTION	UNIT	EST.	FINAL	EST.	FINAL	EST.	FINAL		
	100-6002	PREPARING ROW	STA	32.780				27.830		60.610	
	104-6001	REMOVING CONC (PAV)	SY	113.000				4,281.000		4,394.000	
	104-6017	REMOVING CONC (DRIVEWAYS)	SY	238.000				143.000		381.000	
	104-6054	REMOVING CONCRETE(MOW STRIP)	LF	1,064.000				25.000		1,089.000	
	105-6049	REMOVING STAB BASE & ASPH PAV (4"-22")	SY	7,973.000				10,598.000		18,571.000	
	105-6092	REMOVING STAB BASE AND ASPH PAV (5"-8")	SY	907.000				350.000		1,257.000	
	110-6001	EXCAVATION (ROADWAY)	CY	8,700.000				3,707.000		12,407.000	
	132-6025	EMBANKMENT (FINAL) (DENS CONT) (TY C1)	CY	6,405.000				15,206.000		21,611.000	
	161-6017	COMPOST MANUF TOPSOIL (4")	SY	20,665.000				16,232.000		36,897.000	
	162-6002	BLOCK SODDING	SY	20,665.000				16,232.000		36,897.000	
	164-6051	DRILL SEED (TEMP)(WARM OR COOL)	SY	6,342.000				4,312.000		10,654.000	
	168-6001	VEGETATIVE WATERING	MG	4,018.000				3,056.000		7,074.000	
	260-6016	LIME (HYD, COM, OR QK(SLURRY))	TON	338.000				357.000		695.000	
	260-6027	LIME TRT (EXST MATL)(8")	SY	20,136.000				21,365.000		41,501.000	
	360-6002	CONC PVMT (CONT REINF - CRCP) (8")	SY	10,023.000				13,506.000		23,529.000	
	360-6027	CURB (TYPE II)	LF	4,057.000				4,079.000		8,136.000	
	400-6008	CUT & RESTORE ASPH PAVING	SY	240.000						240.000	
	402-6001	TRENCH EXCAVATION PROTECTION	LF	1,419.000				498.000		1,917.000	
	403-6001	TEMPORARY SPL SHORING	SF	233.000				595.000		828.000	
	416-6029	DRILL SHAFT (RDWY ILL POLE) (30 IN)	LF	8.000						8.000	
	416-6031	DRILL SHAFT (TRF SIG POLE) (30 IN)	LF	11.000						11.000	
	416-6032	DRILL SHAFT (TRF SIG POLE) (36 IN)	LF	13.000						13.000	
	416-6034	DRILL SHAFT (TRF SIG POLE) (48 IN)	LF	22.000						22.000	
	432-6045	RIPRAP (MOW STRIP)(4 IN)	CY	13.000						13.000	
	432-6051	RIPRAP (STONE COMMON)(GROUT)(18 IN)	CY	65.000				100.000		165.000	
	450-6051	RAIL (HANDRAIL)(TY E)	LF	35.000				35.000		70.000	
	450-6103	RAIL (TY PR11)	LF					58.000		58.000	
	462-6011	CONC BOX CULV (6 FT X 4 FT)	LF					132.000		132.000	
	464-6003	RC PIPE (CL III)(18 IN)	LF	533.000				100.000		633.000	
	464-6005	RC PIPE (CL III)(24 IN)	LF	2,117.000				1,838.000		3,955.000	
	464-6009	RC PIPE (CL III)(42 IN)	LF	181.000				213.000		394.000	
	464-6010	RC PIPE (CL III)(48 IN)	LF	64.000						64.000	
	465-6004	MANH (COMPL)(PRM)(72IN)	EA	1.000						1.000	
	465-6032	INLET (COMPL)(PCU)(3FT)(BOTH)	EA	18.000				15.000		33.000	
	465-6135	INLET (COMPL)(PSL)(FG)(5FTX5FT-4FTX4FT)	EA	2.000						2.000	
	466-6102	HEADWALL (CH - PW - 0) (DIA= 42 IN)	EA	1.000						1.000	
	466-6103	HEADWALL (CH - PW - 0) (DIA= 48 IN)	EA	2.000						2.000	



Estimate & Quantity Sheet

CONTROLLING PROJECT ID 1392-01-044

DISTRICT Dallas
HIGHWAY FM 1378, FM 3286

COUNTY Collin

CONTROL SECTION JOB				1392-01-044		1392-01-049		3476-02-013		TOTAL EST.	TOTAL FINAL
PROJECT ID				A00061976		R00005873		A00176186			
COUNTY				Collin		Collin		Collin			
HIGHWAY				FM 1378				FM 3286			
ALT	BID CODE	DESCRIPTION	UNIT	EST.	FINAL	EST.	FINAL	EST.	FINAL		
	466-6135	HEADWALL (CH - PW - S) (DIA= 42 IN)	EA					1.000		1.000	
	466-6171	WINGWALL (PW - 1) (HW=10 FT)	EA					2.000		2.000	
	467-6357	SET (TY II) (18 IN) (RCP) (3: 1) (P)	EA	1.000						1.000	
	467-6363	SET (TY II) (18 IN) (RCP) (6: 1) (P)	EA	18.000				4.000		22.000	
	496-6004	REMOV STR (SET)	EA	23.000				4.000		27.000	
	496-6006	REMOV STR (HEADWALL)	EA	8.000				2.000		10.000	
	496-6007	REMOV STR (PIPE)	LF	231.000				198.000		429.000	
	496-6050	REMOV STR (DRIVEWAY CULVERT)	EA	12.000				4.000		16.000	
	500-6001	MOBILIZATION	LS	0.600				0.400		1.000	
	502-6001	BARRICADES, SIGNS AND TRAFFIC HANDLING	MO	26.000						26.000	
	506-6002	ROCK FILTER DAMS (INSTALL) (TY 2)	LF	104.000				260.000		364.000	
	506-6003	ROCK FILTER DAMS (INSTALL) (TY 3)	LF	104.000				52.000		156.000	
	506-6011	ROCK FILTER DAMS (REMOVE)	LF	208.000				312.000		520.000	
	506-6020	CONSTRUCTION EXITS (INSTALL) (TY 1)	SY	78.000						78.000	
	506-6024	CONSTRUCTION EXITS (REMOVE)	SY	78.000						78.000	
	506-6038	TEMP SEDMT CONT FENCE (INSTALL)	LF	4,391.000				3,845.000		8,236.000	
	506-6039	TEMP SEDMT CONT FENCE (REMOVE)	LF	4,391.000				3,845.000		8,236.000	
	506-6041	BIODEG EROSN CONT LOGS (IN STL) (12")	LF	330.000				407.000		737.000	
	506-6042	BIODEG EROSN CONT LOGS (IN STL) (18")	LF	291.000				110.000		401.000	
	506-6043	BIODEG EROSN CONT LOGS (REMOVE)	LF	621.000				517.000		1,138.000	
	508-6001	CONSTRUCTING DETOURS	SY	4,380.000				1,189.000		5,569.000	
	512-6005	PORT CTB (FUR & INST)(F-SHAPE)(TY 1)	LF	1,140.000				1,170.000		2,310.000	
	512-6029	PORT CTB (MOVE)(F-SHAPE)(TY 1)	LF	1,080.000				900.000		1,980.000	
	512-6053	PORT CTB (REMOVE)(F-SHAPE)(TY 1)	LF	1,140.000				1,140.000		2,280.000	
	529-6011	CONC CURB (DOWEL)	LF	378.000						378.000	
	530-6004	DRIVEWAYS (CONC)	SY	720.000				429.000		1,149.000	
	530-6005	DRIVEWAYS (ACP)	SY	373.000						373.000	
	531-6001	CONC SIDEWALKS (4")	SY	406.000						406.000	
	531-6004	CURB RAMPS (TY 1)	EA	7.000				1.000		8.000	
	531-6010	CURB RAMPS (TY 7)	EA	4.000				4.000		8.000	
	531-6013	CURB RAMPS (TY 10)	EA	4.000						4.000	
	536-6002	CONC MEDIAN	SY	314.000				278.000		592.000	
	536-6004	CONC DIRECTIONAL ISLAND	SY	306.000						306.000	
	538-6001	RIGHT OF WAY MARKERS	EA	10.000				8.000		18.000	
	540-6001	MTL W-BEAM GD FEN (TIM POST)	LF	187.500						187.500	
	540-6016	DOWNSTREAM ANCHOR TERMINAL SECTION	EA	2.000						2.000	
	542-6001	REMOVE METAL BEAM GUARD FENCE	LF	632.000				76.000		708.000	



Estimate & Quantity Sheet

CONTROLLING PROJECT ID 1392-01-044

DISTRICT Dallas
HIGHWAY FM 1378, FM 3286

COUNTY Collin

CONTROL SECTION JOB				1392-01-044		1392-01-049		3476-02-013		TOTAL EST.	TOTAL FINAL
PROJECT ID				A00061976		R00005873		A00176186			
COUNTY				Collin		Collin		Collin			
HIGHWAY				FM 1378				FM 3286			
ALT	BID CODE	DESCRIPTION	UNIT	EST.	FINAL	EST.	FINAL	EST.	FINAL		
	544-6001	GUARDRAIL END TREATMENT (INSTALL)	EA	2.000						2.000	
	544-6003	GUARDRAIL END TREATMENT (REMOVE)	EA	5.000				1.000		6.000	
	545-6003	CRASH CUSH ATTEN (MOVE & RESET)	EA	4.000				2.000		6.000	
	545-6005	CRASH CUSH ATTEN (REMOVE)	EA	4.000				2.000		6.000	
	545-6019	CRASH CUSH ATTEN (INSTL)(S)(N)(TL3)	EA	2.000				4.000		6.000	
	560-6025	RELOCATE EXISTING MAILBOX	EA	6.000				2.000		8.000	
	610-6050	IN RD IL AM (TY SA) 40T-8 (250W) S	EA	1.000						1.000	
	618-6023	CONDT (PVC) (SCH 40) (2")	LF	97.000						97.000	
	618-6029	CONDT (PVC) (SCH 40) (3")	LF	206.000						206.000	
	618-6030	CONDT (PVC) (SCH 40) (3") (BORE)	LF	393.000						393.000	
	618-6046	CONDT (PVC) (SCH 80) (2")	LF	31.000						31.000	
	620-6004	ELEC CONDR (NO.12) INSULATED	LF	312.000						312.000	
	620-6008	ELEC CONDR (NO.8) INSULATED	LF	1,166.000						1,166.000	
	620-6009	ELEC CONDR (NO.6) BARE	LF	655.000						655.000	
	620-6010	ELEC CONDR (NO.6) INSULATED	LF	42.000						42.000	
	624-6002	GROUND BOX TY A (122311)W/APRON	EA	1.000						1.000	
	624-6008	GROUND BOX TY C (162911)W/APRON	EA	5.000						5.000	
	628-6187	ELC SRV TY D 120/240 070(NS)SS(E)PS(U)	EA	1.000						1.000	
	636-6001	ALUMINUM SIGNS (TY A)	SF	6.250						6.250	
	644-6001	IN SM RD SN SUP&AM TY10BWG(1)SA(P)	EA	17.000				10.000		27.000	
	644-6004	IN SM RD SN SUP&AM TY10BWG(1)SA(T)	EA	2.000				3.000		5.000	
	644-6033	IN SM RD SN SUP&AM TYS80(1)SA(U)	EA	2.000				2.000		4.000	
	644-6036	IN SM RD SN SUP&AM TYS80(1)SA(U-BM)	EA	1.000						1.000	
	658-6099	INSTL OM ASSM (OM-2Z)(WFLX)GND	EA	6.000				6.000		12.000	
	662-6063	WK ZN PAV MRK REMOV (W)4"(SLD)	LF	13,033.000				16,050.000		29,083.000	
	662-6075	WK ZN PAV MRK REMOV (W)24"(SLD)	LF	66.000				55.000		121.000	
	662-6095	WK ZN PAV MRK REMOV (Y)4"(SLD)	LF	13,556.000				16,052.000		29,608.000	
	666-6018	REFL PAV MRK TY I (W)6"(DOT)(100MIL)	LF	144.000				38.000		182.000	
	666-6036	REFL PAV MRK TY I (W)8"(SLD)(100MIL)	LF	1,046.000				1,289.000		2,335.000	
	666-6048	REFL PAV MRK TY I (W)24"(SLD)(100MIL)	LF	266.000				204.000		470.000	
	666-6054	REFL PAV MRK TY I (W)(ARROW)(100MIL)	EA	8.000				8.000		16.000	
	666-6078	REFL PAV MRK TY I (W)(WORD)(100MIL)	EA	8.000				8.000		16.000	
	666-6102	REF PAV MRK TY I(W)36"(YLD TRI)(100MIL)	EA	14.000						14.000	
	666-6171	REFL PAV MRK TY II (W) 6" (BRK)	LF	331.000				632.000		963.000	
	666-6172	REFL PAV MRK TY II (W) 6" (DOT)	LF	144.000				38.000		182.000	
	666-6174	REFL PAV MRK TY II (W) 6" (SLD)	LF	1,988.000				2,498.000		4,486.000	
	666-6178	REFL PAV MRK TY II (W) 8" (SLD)	LF	1,046.000				1,289.000		2,335.000	



Estimate & Quantity Sheet

CONTROLLING PROJECT ID 1392-01-044

DISTRICT Dallas
HIGHWAY FM 1378, FM 3286

COUNTY Collin

CONTROL SECTION JOB				1392-01-044		1392-01-049		3476-02-013		TOTAL EST.	TOTAL FINAL
PROJECT ID				A00061976		R00005873		A00176186			
COUNTY				Collin		Collin		Collin			
HIGHWAY				FM 1378				FM 3286			
ALT	BID CODE	DESCRIPTION	UNIT	EST.	FINAL	EST.	FINAL	EST.	FINAL		
	666-6182	REFL PAV MRK TY II (W) 24" (SLD)	LF	203.000				160.000		363.000	
	666-6184	REFL PAV MRK TY II (W) (ARROW)	EA	8.000				8.000		16.000	
	666-6192	REFL PAV MRK TY II (W) (WORD)	EA	8.000				8.000		16.000	
	666-6199	REFL PAV MRK TY II (W) 36" (YLD TRI)	EA	14.000						14.000	
	666-6210	REFL PAV MRK TY II (Y) 6" (SLD)	LF	1,993.000				2,586.000		4,579.000	
	666-6306	RE PM W/RET REQ TY I (W)6"(BRK)(100MIL)	LF	560.000				670.000		1,230.000	
	666-6309	RE PM W/RET REQ TY I (W)6"(SLD)(100MIL)	LF	4,697.000				4,318.000		9,015.000	
	666-6321	RE PM W/RET REQ TY I (Y)6"(SLD)(100MIL)	LF	3,257.000				4,569.000		7,826.000	
	672-6009	REFL PAV MRKR TY II-A-A	EA	68.000				151.000		219.000	
	672-6010	REFL PAV MRKR TY II-C-R	EA	92.000				86.000		178.000	
	677-6001	ELIM EXT PAV MRK & MRKS (4")	LF	6,436.000				19,454.000		25,890.000	
	677-6003	ELIM EXT PAV MRK & MRKS (8")	LF					172.000		172.000	
	677-6007	ELIM EXT PAV MRK & MRKS (24")	LF	22.000				24.000		46.000	
	677-6008	ELIM EXT PAV MRK & MRKS (ARROW)	EA					4.000		4.000	
	677-6012	ELIM EXT PAV MRK & MRKS (WORD)	EA					4.000		4.000	
	678-6002	PAV SURF PREP FOR MRK (6")	LF	8,507.000				9,519.000		18,026.000	
	678-6004	PAV SURF PREP FOR MRK (8")	LF	1,046.000				1,289.000		2,335.000	
	678-6008	PAV SURF PREP FOR MRK (24")	LF	266.000				204.000		470.000	
	678-6009	PAV SURF PREP FOR MRK (ARROW)	EA	8.000				8.000		16.000	
	678-6016	PAV SURF PREP FOR MRK (WORD)	EA	8.000				8.000		16.000	
	678-6023	PAV SURF PREP FOR MRK (36")(YLD TRI)	EA	14.000						14.000	
	678-6033	PAV SURF PREP FOR MRK (RPM)	EA	160.000				237.000		397.000	
	680-6002	INSTALL HWY TRF SIG (ISOLATED)	EA	1.000						1.000	
	680-6004	REMOVING TRAFFIC SIGNALS	EA	1.000						1.000	
	681-6001	TEMP TRAF SIGNALS	EA	1.000						1.000	
	682-6001	VEH SIG SEC (12")LED(GRN)	EA	4.000						4.000	
	682-6002	VEH SIG SEC (12")LED(GRN ARW)	EA	4.000						4.000	
	682-6003	VEH SIG SEC (12")LED(YEL)	EA	4.000						4.000	
	682-6004	VEH SIG SEC (12")LED(YEL ARW)	EA	4.000						4.000	
	682-6005	VEH SIG SEC (12")LED(RED)	EA	4.000						4.000	
	682-6006	VEH SIG SEC (12")LED(RED ARW)	EA	4.000						4.000	
	682-6018	PED SIG SEC (LED)(COUNTDOWN)	EA	4.000						4.000	
	682-6054	BACKPLATE W/REF BRDR(3 SEC)(VENT)ALUM	EA	8.000						8.000	
	684-6031	TRF SIG CBL (TY A)(14 AWG)(5 CONDR)	LF	454.000						454.000	
	684-6033	TRF SIG CBL (TY A)(14 AWG)(7 CONDR)	LF	561.000						561.000	
	684-6036	TRF SIG CBL (TY A)(14 AWG)(10 CONDR)	LF	692.000						692.000	
	684-6079	TRF SIG CBL (TY C)(12 AWG)(2 CONDR)	LF	704.000						704.000	



Estimate & Quantity Sheet

CONTROLLING PROJECT ID 1392-01-044

DISTRICT Dallas
HIGHWAY FM 1378, FM 3286

COUNTY Collin

CONTROL SECTION JOB				1392-01-044		1392-01-049		3476-02-013		TOTAL EST.	TOTAL FINAL
PROJECT ID				A00061976		R00005873		A00176186			
COUNTY				Collin		Collin		Collin			
HIGHWAY				FM 1378				FM 3286			
ALT	BID CODE	DESCRIPTION	UNIT	EST.	FINAL	EST.	FINAL	EST.	FINAL		
	685-6005	RELOCT RDSO FLSH BCN AM (SOLAR PWRD)	EA	1.000						1.000	
	686-6031	INS TRF SIG PL AM(S)1 ARM(28')LUM	EA	1.000						1.000	
	686-6043	INS TRF SIG PL AM(S)1 ARM(40')LUM	EA	1.000						1.000	
	686-6067	INS TRF SIG PL AM(S)1 ARM(65')LUM	EA	1.000						1.000	
	687-6001	PED POLE ASSEMBLY	EA	2.000						2.000	
	688-6001	PED DETECT PUSH BUTTON (APS)	EA	4.000						4.000	
	688-6003	PED DETECTOR CONTROLLER UNIT	EA	1.000						1.000	
	730-6107	FULL - WIDTH MOWING	CYC	3.000						3.000	
	734-6002	LITTER REMOVAL	CYC	3.000						3.000	
	2004-6001	DECOMPOSED GRANITE (3" DEPTH)	SY	841.000				1,533.000		2,374.000	
	3077-6001	SP MIXESSP-BPG64-22	TON	5,293.000				5,363.000		10,656.000	
	3077-6013	SP MIXESSP-CSAC-B PG64-22	TON	956.000				746.000		1,702.000	
	3077-6075	TACK COAT	GAL	1,032.000				818.000		1,850.000	
	6001-6002	PORTABLE CHANGEABLE MESSAGE SIGN	EA	2.000				1.000		3.000	
	6058-6001	BBU SYSTEM (EXTERNAL BATT CABINET)	EA	1.000						1.000	
	6185-6002	TMA (STATIONARY)	DAY	259.000				173.000		432.000	
	6185-6003	TMA (MOBILE OPERATION)	HR	80.000				70.000		150.000	
	6292-6003	RVDS(PRESENCE AND ADVANCE DET)	EA	3.000						3.000	
	6306-6006	VIVDS TEMPORARY	EA	1.000						1.000	
	7316-6001	20" AWWA C303 RCCP	LF			1,453.000				1,453.000	
	7316-6002	20"X20" 90 DEGREE RCCP BEND	EA			2.000				2.000	
	7316-6003	20"X20" 73 DEGREE RCCP BEND	EA			1.000				1.000	
	7316-6004	20" X 20" 45 DEGREE RCCP BEND	EA			7.000				7.000	
	7316-6005	REMOVE EXISTING WATER MAIN	LS			1.000				1.000	
	7316-6006	THRUST RESTRAINT	LF			547.000				547.000	
	7316-6007	EXISTING PIPE JOINT RESTRAINTS	LF			110.000				110.000	
	7316-6008	CONNECT TO EXISTING WATERLINE	EA			2.000				2.000	
	7316-6009	TESTING AND DISINFECTION	LS			1.000				1.000	
	7316-6010	6" COMBINATION AIR RELEASE ASSEMBLY	EA			1.000				1.000	
	7316-6011	8" BLOWOFF VALVE ASSEMBLY	EA			2.000				2.000	
	7316-6013	TRENCH EXCAVATION SAFETY & SUPPORT	LF			1,453.000				1,453.000	
	7316-6014	SALVAGE EXIST BLOW-OFF VALVE & PIPING	EA			2.000				2.000	
	7316-6015	SILT FENCE	LF			1,453.000				1,453.000	
	7316-6016	SAND BACKFILL	CY			45.000				45.000	
	7316-6017	FLOWABLE FILL	CY			22.000				22.000	
	7316-6018	REM DERILICT WOODEN SHED	LS			1.000				1.000	
	7316-6019	REM & REPLACE WOODEN FENCE	LF			668.000				668.000	



Estimate & Quantity Sheet

CONTROLLING PROJECT ID 1392-01-044

DISTRICT Dallas
HIGHWAY FM 1378, FM 3286

COUNTY Collin

CONTROL SECTION JOB				1392-01-044		1392-01-049		3476-02-013		TOTAL EST.	TOTAL FINAL
PROJECT ID				A00061976		R00005873		A00176186			
COUNTY				Collin		Collin		Collin			
HIGHWAY				FM 1378				FM 3286			
ALT	BID CODE	DESCRIPTION	UNIT	EST.	FINAL	EST.	FINAL	EST.	FINAL		
	7316-6020	REM & REPLACE CHAIN LINK FENCE	LS			92.000				92.000	
	7316-6021	REM & REPLACE BARBED WIRE FENCE	LF			30.000				30.000	
	7316-6022	REM & REPLACE BOX WIRE FENCE	EA			200.000				200.000	
	7316-6023	REM & REPLACE 12IN CMP	LF			20.000				20.000	
	7316-6024	INSTALL ACCESS GATE	EA			5.000				5.000	
	7316-6025	REMOVE & REPLACE TREE	EA			2.000				2.000	
	7316-6026	REMOVE TREE	EA			8.000				8.000	
	7316-6027	REMOVE & REPLACE ASPHALT DRIVEWAY	SY			406.000				406.000	
	7316-6028	RESTORATION & SEEDING	AC			2.000				2.000	
	7316-6029	SWPPP	EA			1.000				1.000	
	7316-6030	DISP OF HVY CHLOR WATER MN FLUS WATER	LF			1,453.000				1,453.000	
	7316-6031	CONST SURV & STAKING (W & WW MAINS)	LF			1,453.000				1,453.000	
	18	SAFETY CONTINGENCY: CONTRACTOR FORCE ACCOUNT WORK (PARTICIPATING)	LS	1.000						1.000	
		LAW ENFORCEMENT: CONTRACTOR FORCE ACCOUNT WORK (PARTICIPATING)	LS	1.000						1.000	
		EROSION CONTROL MAINTENANCE: CONTRACTOR FORCE ACCOUNT WORK (PART)	LS	1.000						1.000	

DATE: 4/6/2023 TIME: 12:46:46 PM FILE: c:\txdot\pw\onl\ine\txdot5\ibrahim.e\saad\0485483\Summary Sheets.dgn

SUMMARY OF WORKZONE TRAFFIC CONTROL ITEMS FM 1378- CSJ: 1392-01-044																				
LOCATION	400 6008	403 6001	500 6001	502 6001	508 6001	512 6005	512 6029	512 6053	545 6003	545 6005	545 6019	529 6011	662 6063	662 6075	662 6095	677 6001	677 6007	6001 6002	6185 6002	6185 6003
	CUT & RESTORE ASPH PAVING	TEMPORARY SPL SHORING	MOBILIZAT ION	BARRICADES, SIGNS AND TRAFFIC HANDLING	CONSTRUCT ING DETOURS	PORT CTB (FUR & INST)(F- SHAPE)(TY 1)	PORT CTB (MOVE)(F- SHAPE)(TY 1)	PORT CTB (REMOVE) (F-SHAPE) (TY 1)	CRASH CUSH ATTEN (MOVE & RESET)	CRASH CUSH ATTEN (REMOVE)	CRASH CUSH ATTEN (INSTL)(S)(N)(TL3)	CONC CURB (DOWEL)	WK ZN PAV MRK REMOV (W)4"(SL D)	WK ZN PAV MRK REMOV (W)24"(S LD)	WK ZN PAV MRK REMOV (Y)4"(SL D)	ELIM EXT PAV MRK & MRKS (4")	ELIM EXT PAV MRK & MRKS (24")	PORTABLE CHANGEAB LE MESSAGE SIGN	TMA (STATION ARY)	TMA (MOBILE OPERATIO N)
	SY	SF	LS	MO	SY	LF	LF	LF	EA	EA	EA	LF	LF	LF	LF	LF	LF	EA	DAY	HR
PHASE 1 STAGE 1-A					2900								1408		1409	2816		2		
PHASE 1 STAGE 1-B					171															
PHASE 1 STAGE 1-C													991		1163	1409				
PHASE 1 STAGE 2	240	233			1309	1140		60	2	2	2		5222	44	5225	2211	22			
PHASE 2 STAGE 1							1080	1080	2	2			5412	22	5759					
PHASE 2 STAGE 2												378								
			0.6	26															259	80
PROJECT TOTALS	240	233	0.6	26	4380	1140	1080	1140	4	4	2	378	13033	66	13556	6436	22	2	259	80

SUMMARY OF WORKZONE TRAFFIC CONTROL ITEMS FM 3286- CSJ: 3476-02-013																				
LOCATION	403 6001	500 6001	508 6001	512 6005	512 6029	512 6053	545 6003	545 6005	545 6019	662 6063	662 6075	662 6095	677 6001	677 6003	677 6007	677 6008	677 6012	6001 6002	6185 6002	6185 6003
	TEMPORARY SPL SHORING	MOBILIZA TION	CONSTRUCT ING DETOURS	PORT CTB (FUR & INST)(F- SHAPE)(TY 1)	PORT CTB (MOVE)(F- SHAPE)(TY 1)	PORT CTB (REMOVE) (F-SHAPE) (TY 1)	CRASH CUSH ATTEN (MOVE & RESET)	CRASH CUSH ATTEN (REMOVE)	CRASH CUSH ATTEN (INSTL)(S)(N)(TL3)	WK ZN PAV MRK REMOV (W)4"(SL D)	WK ZN PAV MRK REMOV (W)24"(S LD)	WK ZN PAV MRK REMOV (Y)4"(SL D)	ELIM EXT PAV MRK & MRKS (4")	ELIM EXT PAV MRK & MRKS (8")	ELIM EXT PAV MRK & MRKS (24")	ELIM EXT PAV MRK & MRKS (ARROW)	ELIM EXT PAV MRK & MRKS (WORD)	PORTABLE CHANGEAB LE MESSAGE SIGN	TMA (STATION ARY)	TMA (MOBILE OPERATIO N)
	SF	LS	SY	LF	LF	LF	EA	EA	EA	LF	LF	LF	LF	LF	LF	EA	EA	EA	DAY	HR
PHASE 1 STAGE 1-A	595		1189	900					4	5742	22	5745	11488	172	24	4	4	1		
PHASE 1 STAGE 1-B																				
PHASE 1 STAGE 1-C																				
PHASE 1 STAGE 2				240	900	1140	2	2		5656	22	5656	7966							
PHASE 2 STAGE 1										4652	11	4651								
PHASE 2 STAGE 2																				
		0.4																	173	70
PROJECT TOTALS	595	0.4	1189	1140	900	1140	2	2	4	16050	55	16052	19454	172	24	4	4	1	173	70

© 2023



**FM 1378
AT FM 3286
SUMMARY SHEETS
(TRAFFIC CONTROL PLAN)**

SHEET 1 OF 7

DESIGN JI	FED. RD. DIV. NO.	FEDERAL AID PROJECT NO.		HIGHWAY NO.
GRAPHICS JI	6	SEE TITLE SHEET		FM 1378, ETC.
CHECK IIE	STATE	DISTRICT	COUNTY	SHEET NO.
CHECK	TEXAS	DAL	COLLIN	14
	CONTROL	SECTION	JOB	
	1392	01	044, ETC.	

DATE: 2/21/2023 TIME: 11:42:51 AM FILE: c:\txdot\pwworking\line\txdot5\ibrahim.e\saad\0485483\Summary Sheets.dgn

SUMMARY OF REMOVAL ITEMS FM 1378- CSJ: 1392-01-044

LOCATION	104 6001	104 6017	104 6054	105 6049	105 6092	496 6004	496 6006	496 6007	496 6050	542 6001	544 6003	560 6025
	REMOVING CONC (PAV)	REMOVING CONC (DRIVEWAYS)	REMOVING CONCRETE (MOW STRIP)	REMOVING STAB BASE & ASPH PAV (4"-22")	REMOVING STAB BASE AND ASPH PAV (5"-8")	REMOV STR (SET)	REMOV STR (HEADWAL L)	REMOV STR (PIPE)	REMOV STR (DRIVEWAY CULVERT)	REMOVE METAL BEAM GUARD FENCE	GUARDRAIL END TREATMENT (REMOVE)	RELOCATE EXISTING MAILBOX
	SY	SY	LF	SY	SY	EA	EA	LF	EA	LF	EA	EA
SHEET 1 OF 4		84	503	2225	178	5	2	46	3	247	3	1
SHEET 2 OF 4			417	978	81		3	130		319	1	
SHEET 3 OF 4												
SHEET 4 OF 4	113	154	144	4770	648	18	3	55	9	66	1	5
PROJECT TOTALS	113	238	1064	7973	907	23	8	231	12	632	5	6

SUMMARY OF REMOVAL ITEMS FM 3286- CSJ: 3476-02-013

LOCATION	104 6001	104 6017	104 6054	105 6049	105 6092	496 6004	496 6006	496 6007	496 6050	542 6001	544 6003	560 6025
	REMOVING CONC (PAV)	REMOVING CONC (DRIVEWAYS)	REMOVING CONCRETE (MOW STRIP)	REMOVING STAB BASE & ASPH PAV (4"-22")	REMOVING STAB BASE AND ASPH PAV (5"-8")	REMOV STR (SET)	REMOV STR (HEADWAL L)	REMOV STR (PIPE)	REMOV STR (DRIVEWAY CULVERT)	REMOVE METAL BEAM GUARD FENCE	GUARDRAIL END TREATMENT (REMOVE)	RELOCATE EXISTING MAILBOX
	SY	SY	LF	SY	SY	EA	EA	LF	EA	LF	EA	EA
SHEET 1 OF 4												
SHEET 2 OF 4		143	25	4217	194	4	2	198	2	76	1	
SHEET 3 OF 4	4281			6381	156				2			2
SHEET 4 OF 4												
PROJECT TOTALS	4281	143	25	10598	350	4	2	198	4	76	1	2



© 2023

FM 1378
AT FM 3286
SUMMARY SHEETS
(REMOVAL)

SHEET 2 OF 7

DESIGN JI	FED. RD. DIV. NO.	FEDERAL AID PROJECT NO.		HIGHWAY NO.
GRAPHICS JI	6	SEE TITLE SHEET		FM 1378, ETC.
CHECK JI	STATE	DISTRICT	COUNTY	SHEET NO.
CHECK	TEXAS	DAL	COLLIN	15
	CONTROL	SECTION	JOB	
	1392	01	044, ETC.	

SUMMARY OF ROADWAY ITEMS FM 1378- CSJ: 1392-01-044																									
LOCATION	100 6002	161 6017	162 6002	168 6001	260 6016	260 6027	360 6002	360 6027	432 6045	530 6004	530 6005	531 6001	531 6004	531 6010	531 6013	536 6002	536 6004	540 6001	540 6016	544 6001	2004 6001	3077 6001	3077 6013	3077 6075	538 6001
	PREPARING ROW	COMPOST MANUF TOPSOIL (4")	BLOCK SODDING	VEGETATIV E WATERING	LIME (HYD, COM OR OK(SLURR Y))	LIME TRT (EXST MATL)(8")	CONC PVMT (CONT REINF - CRCP) (8")	CURB (TYPE II)	RIPRAP (MOW STRIP)(4 IN)	DRIVEWAYS (CONC)	DRIVEWAYS (ACP)	CONC SIDEWALKS (4")	CURB RAMPS (TY 1)	CURB RAMPS (TY 7)	CURB RAMPS (TY 10)	CONC MEDIAN	CONC DIRECTIO NAL ISLAND	MTL W-BEAM GD FEN (TIM POST)	DOWNSTREA M ANCHOR TERMINAL SECTION	GUARDRAIL END TREATMENT (INSTALL)	DECOMPOSE D GRANITE (3" DEPTH)	SP MIXES SP-B PG64-22	SP MIXES SP-C SAC-B PG64-22	TACK COAT	RIGHT OF WAY MARKERS
	STA	SY	SY	MG	TON	SY	SY	LF	CY	SY	SY	SY	EA	EA	EA	SY	SY	LF	EA	EA	SY	TON	TON	GAL	EA
SHEET 1 OF 6		874	874	130	102	6100	3366	1475		176	76			3							628	1543	253	264	4
SHEET 2 OF 6		288	288	43	71	4262	3963	1452				190	7	1		166	306				213	938			2
SHEET 3 OF 6																									
SHEET 4 OF 6																									
SHEET 5 OF 6					24	1387	104			78	175											410	127	140	
SHEET 6 OF 6					141	8387	2590	1130	13	466	122	216			4	148		187.5	2	2		2402	576	628	4
	32.78																								
PROJECT TOTALS	32.78	1162	1162	173	338	20136	10023	4057	13	720	373	406	7	4	4	314	306	187.5	2	2	841	5293	956	1032	10

SUMMARY OF ROADWAY ITEMS FM 3286- CSJ: 3476-02-013																			
LOCATION	100 6002	161 6017	162 6002	168 6001	260 6016	260 6027	360 6002	360 6027	512 6005	530 6004	531 6004	531 6010	536 6002	2004 6001	3077 6001	3077 6013	3077 6075	538 6001	
	PREPARING ROW	COMPOST MANUF TOPSOIL (4")	BLOCK SODDING	VEGETATIVE WATERING	LIME (HYD, COM OR OK(SLURR Y))	LIME TRT (EXST MATL)(8")	CONC PVMT (CONT REINF - CRCP) (8")	CURB (TYPE II)	PORT CTB (FUR & INST)(F- SHAPE)(TY 1)	DRIVEWAYS (CONC)	CURB RAMPS (TY 1)	CURB RAMPS (TY 7)	CONC MEDIAN	DECOMPOSE D GRANITE (3" DEPTH)	SP MIXES SP-B PG64-22	SP MIXES SP-C SAC-B PG64-22	TACK COAT	RIGHT OF WAY MARKERS	
	STA	SY	SY	MG	TON	SY	SY	LF	LF	SY	EA	EA	SY	SY	TON	TON	GAL	EA	
SHEET 1 OF 6																			
SHEET 2 OF 6		451	451	67	164	9807	9218	3110	30	334	1	3	278	940	2166	14	15	4	
SHEET 3 OF 6					157	9412	4153	969		95		1		593	2552	527	578	4	
SHEET 4 OF 6					36	2146	135								645	205	225		
SHEET 5 OF 6																			
SHEET 6 OF 6																			
	27.83																		
PROJECT TOTALS	27.83	451	451	67	357	21365	13506	4079	30	429	1	4	278	1533	5363	746	818	8	

FILE: c:\txdot\pw\online\txdot5\ibrahim.e\isoad\0485483\Summary Sheets.dgn
 DATE: 2/28/2023 TIME: 4:07:38 PM

© 2023



Texas Department of Transportation

FM 1378
AT FM 3286
SUMMARY SHEETS
(ROADWAY)

SHEET 3 OF 7

DESIGN	FED. RD. DIV. NO.	FEDERAL AID PROJECT NO.		HIGHWAY NO.
JI	6	SEE TITLE SHEET		FM 1378, ETC.
GRAPHICS	STATE	DISTRICT	COUNTY	SHEET NO.
JI	TEXAS	DAL	COLLIN	16
CHECK	CONTROL	SECTION	JOB	
CHECK	1392	01	044, ETC.	

FILE: c:\txdot\pw\on1\ine\tx\dot\5\ibrahim.e\saad\0485483\Summary Sheets.dgn

DATE: 2/2/2023 TIME: 9:04:02 AM

SUMMARY OF DRAINAGE ITEMS FM 1378- CSJ: 1392-01-044												
LOCATION	SEWER EXCAV (PIPE) CY	402 6001	432 6051	465 6004	450 6051	464 6005	464 6009	464 6010	465 6032	465 6135	466 6102	466 6103
		TRENCH EXCAVATION PROTECTION LF	RIPRAP (STONE COMMON) (GROUT) (18 IN) CY	MANH (COMPL) (PRM) (72 IN) EA	RAIL (HANDRAIL) (TYPE) LF	RC PIPE (CL III) (24 IN) LF	RC PIPE (CL III) (42 IN) LF	RC PIPE (CL III) (48 IN) LF	INLET (COMPL) (PCU) (3FT) (BOTH) EA	INLET (COMPL) (PSL) (FG) (5FTX5FT-4FTX4FT) EA	HEADWALL (CH - PW) (0) (DIA) (42 IN) EA	HEADWALL (CH - PW) (0) (DIA) (48 IN) EA
CULVERT A		181	35	1	35		181				1	
CULVERT B												
CULVERT C		42	30				64					2
NETWORK A1 (SHEET 1 OF 2)	641					284			3			
NETWORK A1 (SHEET 2 OF 2)	975	72				432			2			
NETWORK A2 (SHEET 1 OF 1)	776	346				344			1	1		
NETWORK A3 (SHEET 1 OF 2)	598	265				265			3			
NETWORK A3 (SHEET 2 OF 2)	519	230				230			2			
NETWORK A4 (SHEET 1 OF 1)	382	169				169			3			
NETWORK A5 (SHEET 1 OF 1)	409	68				181			3			
NETWORK A6 (SHEET 1 OF 1)	104	46				46			1			
NETWORK A5 (SHEET 1 OF 1)												
NETWORK A6 (SHEET 1 OF 1)												
NETWORK B1 (SHEET 1 OF 2)												
NETWORK B1 (SHEET 2 OF 2)												
NETWORK B2 (SHEET 1 OF 2)												
NETWORK B2 (SHEET 2 OF 2)												
NETWORK B3 (SHEET 1 OF 1)												
NETWORK B4 (SHEET 1 OF 1)												
NETWORK D1 (SHEET 1 OF 2)	313					166				1		
DITCH LAYOUT SHEET 1 OF 6												
SHEET 2 OF 6												
SHEET 5 OF 6												
SHEET 6 OF 6												
PROJECT TOTALS	4717	1419	65	1	35	2117	181	64	18	2	1	2

* : FOR CONTRACTORS INFORMATION ONLY

SUMMARY OF DRAINAGE ITEMS FM 3286- CSJ: 3476-02-013													
LOCATION	SEWER EXCAV (PIPE) CY	402 6001	467 6363	432 6051	450 6051	450 6103	462 6011	STRUCT EXCAV (PIPE)	464 6005	464 6009	465 6032	466 6135	466 6171
		TRENCH EXCAVATION PROTECTION LF	SET (TY III) (18 IN) (RCP) (6:1) (P) EA	RIPRAP (STONE COMMON) (GROUT) (18 IN) CY	RAIL (HANDRAIL) (TYPE) LF	RAIL (TY PR11) LF	CONC BOX CULV (6 FT X 4 FT) LF		RC PIPE (CL III) (24 IN) LF	RC PIPE (CL III) (42 IN) LF	INLET (COMPL) (PCU) (3FT) (BOTH) EA	HEADWALL (CH - PW) (S) (DIA) (42 IN) EA	WINGWALL (PW - 1) (HW=10 FT) EA
CULVERT A		133		24	35							1	
CULVERT B		96		76		58	132	425		213			2
CULVERT C													
NETWORK A1 (SHEET 1 OF 2)													
NETWORK A1 (SHEET 2 OF 2)													
NETWORK A2 (SHEET 1 OF 1)													
NETWORK A3 (SHEET 1 OF 2)													
NETWORK A3 (SHEET 2 OF 2)													
NETWORK A4 (SHEET 1 OF 1)													
NETWORK A5 (SHEET 1 OF 1)													
NETWORK A6 (SHEET 1 OF 1)													
NETWORK B1 (SHEET 1 OF 2)	876								388		3		
NETWORK B1 (SHEET 2 OF 2)	327	29							145		2		
NETWORK B2 (SHEET 1 OF 2)	899	158							398		3		
NETWORK B2 (SHEET 2 OF 2)	330								146		1		
NETWORK B3 (SHEET 1 OF 1)	811	57							359		3		
NETWORK B4 (SHEET 1 OF 1)	908	25							402		3		
NETWORK D1 (SHEET 1 OF 1)													
DITCH LAYOUT SHEET 3 OF 6			4										
SHEET 4 OF 6													
PROJECT TOTALS	4151	498	4	100	35	58	132	425	1838	213	15	1	2

* : FOR CONTRACTORS INFORMATION ONLY

SUMMARY OF DRIVEWAY DRAINAGE ITEMS: FM 1378- CSJ: 1392-01-044			
LOCATION	464 6003	467 6357	467 6363
	RC PIPE (CL III) (18 IN) LF	SET (TY III) (18") (RCP) (3:1) (P) EA	SET (TY III) (18") (RCP) (6:1) (P) EA
DITCH LAYOUT SHEET 1 OF 6	227	1	6
SHEET 2 OF 6			
SHEET 5 OF 6	112		4
SHEET 6 OF 6	194		8
PROJECT TOTALS	533	1	18

SUMMARY OF DRIVEWAY DRAINAGE ITEMS: FM 3286- CSJ: 3476-02-012		
LOCATION	464 6003	467 6363
	RC PIPE (CL III) (18 IN) LF	SET (TY III) (18") (RCP) (6:1) (P) EA
DITCH LAYOUT SHEET 3 OF 6	100	4
SHEET 4 OF 6		
PROJECT TOTALS	100	4



© 2023

**FM 1378
AT FM 3286
SUMMARY SHEETS
(DRAINAGE)**

SHEET 4 OF 7

DESIGN JI	FED. RD. DIV. NO. 6	FEDERAL AID PROJECT NO. SEE TITLE SHEET		HIGHWAY NO. FM 1378, ETC.
GRAPHICS JI	STATE TEXAS	DISTRICT DAL	COUNTY COLLIN	SHEET NO. 17
CHECK	CONTROL 1392	SECTION 01	JOB 044, ETC.	

DATE: 2/17/2023 TIME: 11:24:18 AM FILE: c:\t\dot\pw\on\line\t\dot5\ibrahim.e\isoad\0485483\Summary Sheets.s.dgn

SUMMARY OF PAVEMENT MARKING ITEMS FM 1378- CSJ: 1392-01-044																							
LOCATION	658 6099	666 6018	666 6036	666 6048	666 6054	666 6078	666 6171	666 6172	666 6174	666 6178	666 6182	666 6184	666 6192	666 6210	666 6306	666 6309	666 6321	672 6010	672 6009	678 6002	678 6004	678 6008	
	INSTL OM ASSM (OM-2Z) (WFLX)GND	REFL PAV MRK TY I (W)6"(DO T)(100MIL)	REFL PAV MRK TY I (W)8"(SL D)(100MIL)	REFL PAV MRK TY I (W)24"(S LD)(100MIL)	REFL PAV MRK TY I (W)(ARRO W)(100MIL)	REFL PAV MRK TY I (W)(WORD) (100MIL)	REFL PAV MRK TY II (W) 6" (BRK)	REFL PAV MRK TY II (W) 6" (DOT)	REFL PAV MRK TY II (W) 6" (SLD)	REFL PAV MRK TY II (W) 8" (SLD)	REFL PAV MRK TY II (W) 24" (SLD)	REFL PAV MRK TY II (W) 24" (SLD)	REFL PAV MRK TY II (W) (ARROW)	REFL PAV MRK TY II (W) (WORD)	REFL PAV MRK TY II (Y) 6" (SLD)	RE PM W/RET REQ TY I (W)6"(BR K)(100MIL)	RE PM W/RET REQ TY I (W)6"(SL D)(100MIL)	RE PM W/RET REQ TY I (Y)6"(SL D)(100MIL)	REFL PAV MRKR TY II-C-R	REFL PAV MRKR TY II-A-A	PAV SURF PREP FOR MRK (6")	PAV SURF PREP FOR MRK (8")	PAV SURF PREP FOR MRK (24")
	EA	LF	LF	LF	EA	EA	LF	LF	LF	LF	LF	EA	EA	LF	LF	LF	LF	EA	EA	LF	LF	LF	
SHEET 1 OF 6			84	13			21		169	84				167	77	827	830	8	34	1734	84	13	
SHEET 2 OF 6	2	144	962	203	8	8	310	144	1819	962	203	8	8	1826	330	1850	1857	76		4030	962	203	
SHEET 3 OF 6																							
SHEET 4 OF 6																							
SHEET 5 OF 6															28						28		
SHEET 6 OF 6	4			50											153	1992	570	8	34	2715		50	
PROJECT TOTALS	6	144	1046	266	8	8	331	144	1988	1046	203	8	8	1993	560	4697	3257	92	68	8507	1046	266	

SUMMARY OF PAVEMENT MARKING ITEMS FM 1378- CSJ: 1392-01-044						
LOCATION	678 6009	678 6016	678 6033	666 6102	666 6199	678 6023
	PAV SURF PREP FOR MRK (ARROW)	PAV SURF PREP FOR MRK (WORD)	PAV SURF PREP FOR MRK (RPM)	REF PAV MRK TY I(W)36" (YLD TRI)(100M IL)	REFL PAV MRK TY II (W) 36" (YLD TRI)	PAV SURF PREP FOR MRK (36")(YLD TRI)
	EA	EA	EA	EA	EA	EA
SHEET 1 OF 6			42			
SHEET 2 OF 6	8	8	76	14	14	14
SHEET 3 OF 6						
SHEET 4 OF 6						
SHEET 5 OF 6						
SHEET 6 OF 6			42			
PROJECT TOTALS	8	8	160	14	14	14

SUMMARY OF PAVEMENT MARKING ITEMS FM 3286- CSJ: 3476-02-013																										
LOCATION	658 6099	666 6018	666 6036	666 6048	666 6054	666 6078	666 6171	666 6172	666 6174	666 6178	666 6182	666 6184	666 6192	666 6210	666 6306	666 6309	666 6321	672 6010	672 6009	678 6002	678 6004	678 6008	678 6009	678 6016	678 6033	
	INSTL OM ASSM (OM-2Z) (WFLX)GND	REFL PAV MRK TY I (W)6"(DO T)(100MIL)	REFL PAV MRK TY I (W)8"(SL D)(100MIL)	REFL PAV MRK TY I (W)24"(S LD)(100MIL)	REFL PAV MRK TY I (W)(ARRO W)(100MIL)	REFL PAV MRK TY I (W)(WORD) (100MIL)	REFL PAV MRK TY II (W) 6" (BRK)	REFL PAV MRK TY II (W) 6" (DOT)	REFL PAV MRK TY II (W) 6" (SLD)	REFL PAV MRK TY II (W) 8" (SLD)	REFL PAV MRK TY II (W) 24" (SLD)	REFL PAV MRK TY II (W) 24" (SLD)	REFL PAV MRK TY II (W) (ARROW)	REFL PAV MRK TY II (W) (WORD)	REFL PAV MRK TY II (Y) 6" (SLD)	RE PM W/RET REQ TY I (W)6"(BR K)(100MIL)	RE PM W/RET REQ TY I (W)6"(SL D)(100MIL)	RE PM W/RET REQ TY I (Y)6"(SL D)(100MIL)	REFL PAV MRKR TY II-C-R	REFL PAV MRKR TY II-A-A	PAV SURF PREP FOR MRK (6")	PAV SURF PREP FOR MRK (8")	PAV SURF PREP FOR MRK (24")	PAV SURF PREP FOR MRK (ARROW)	PAV SURF PREP FOR MRK (WORD)	PAV SURF PREP FOR MRK (RPM)
	EA	LF	LF	LF	EA	EA	LF	LF	LF	LF	LF	EA	EA	LF	LF	LF	LF	EA	EA	LF	LF	LF	EA	EA	EA	
SHEET 1 OF 6																										
SHEET 2 OF 6	2	38	1200	160	7	8	332	38	1171	1200	160	7	8	1367	332	1171	1367	62		2870	1200	160	7	8	62	
SHEET 3 OF 6	4		89	29	1		300		1327	89		1		1219	338	2020	2075	24	102	4395	89	29	1		126	
SHEET 4 OF 6				15												1127	1127		49	2254		15			49	
SHEET 5 OF 6																										
SHEET 6 OF 6																										
PROJECT TOTALS	6	38	1289	204	8	8	632	38	2498	1289	160	8	8	2586	670	4318	4569	86	151	9519	1289	204	8	8	237	



FM 1378
AT FM 3286
SUMMARY SHEETS
(PAVEMENT MARKINGS)

SHEET 5 OF 7

DESIGN	J1	FED. RD. DIV. NO.	6	FEDERAL AID PROJECT NO.	SEE TITLE SHEET	HIGHWAY NO.	FM 1378, ETC.
GRAPHICS	J1	STATE	TEXAS	DISTRICT	DAL	COUNTY	COLLIN
CHECK		CONTROL	SECTION	JOB			
CHECK		1392	01	044, ETC.			

18

FILE: c:\txdot\pw\onl\ine\txdot5\ibrahim.e\saad\0485483\Earthwork Summary Sheet.dgn
 DATE: 2/1/2023
 TIME: 2:43:29 PM

LOCATION FM 1378 CSJ: 1392-01-044 ☐ "FM1378"	110 6001	132 6025
	EXCAVATION (ROADWAY)	EMBANKMENT (FINAL) (DENS CONT) (TY C1)
	CY	CY
STA 12+25	0	0
STA 13+00	38	9
STA 14+00	79	12
STA 15+00	165	128
STA 16+00	132	501
STA 17+00	67	716
STA 18+00	219	600
STA 19+00	311	285
STA 20+00	236	496
STA 21+00	118	849
STA 21+91.18	33	610
ROADWAY SUBTOTAL	1398	4206

LOCATION FM 1378 CSJ: 1392-01-044 ☐ "SOUTHVIEW1"	110 6001	132 6025
	EXCAVATION (ROADWAY)	EMBANKMENT (FINAL) (DENS CONT) (TY C1)
	CY	CY
STA 94+86.50	0	0
STA 95+00	5	2
STA 96+00	72	42
STA 97+00	75	25
STA 98+00	87	27
STA 99+00	97	74
STA 100+00	118	103
STA 101+00	122	104
STA 102+00	92	155
STA 103+00	98	153
STA 104+00	244	69
STA 105+00	456	63
STA 106+00	565	42
STA 107+00	1071	1
STA 108+00	1798	0
STA 109+00	1594	2
STA 110+00	702	463
STA 110+81.48	106	874
ROADWAY SUBTOTAL	7302	2199
CSJ TOTAL	8700	6405

SUMMARY OF EARTHWORK ITEMS		
LOCATION FM 3286 CSJ: 3476-02-013 ☐ "FM1378"	110 6001	132 6025
	EXCAVATION (ROADWAY)	EMBANKMENT (FINAL) (DENS CONT) (TY C1)
	CY	CY
STA 23+00	38	285
STA 24+00	167	1031
STA 25+00	309	1723
STA 26+00	275	1095
STA 27+00	202	839
STA 28+00	209	909
STA 29+00	139	925
STA 30+00	81	1928
STA 31+00	92	1556
STA 32+00	138	1109
STA 33+00	208	621
STA 34+00	271	516
STA 35+00	318	366
STA 36+00	296	227
STA 37+00	251	226
STA 38+00	193	257
STA 39+00	133	272
STA 40+00	120	323
STA 41+00	93	336
STA 42+00	48	286
STA 43+00	29	207
STA 44+00	29	122
STA 45+00	47	43
STA 45+63.27	21	4
ROADWAY SUBTOTAL	3707	15206
CSJ TOTAL	3707	15206
PROJECT TOTAL	12407	21611

EARTHWORK CALCULATION DETAILS

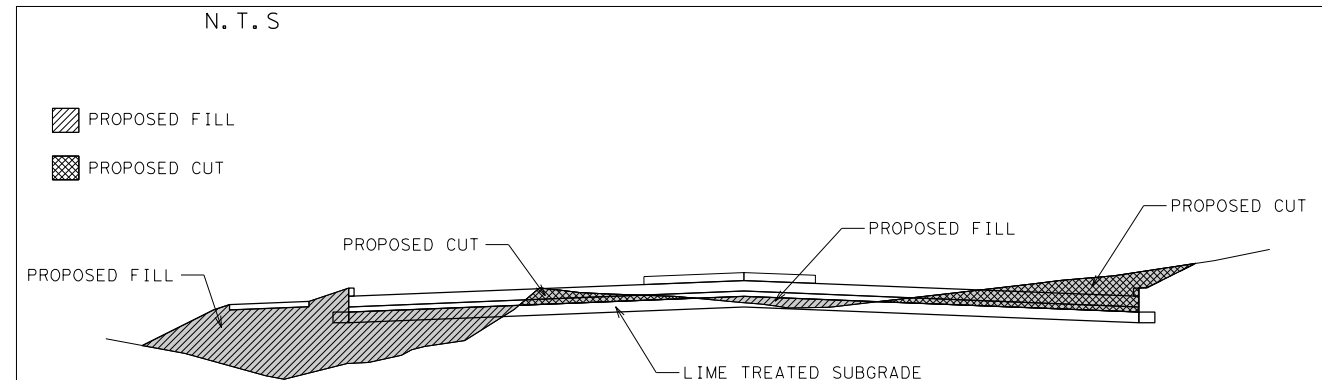

CONTRACTOR INFORMATION

EXISTING PAVEMENT STRUCTURE WAS NOT SUBTRACTED OUT FOR EARTHWORK CALCULATIONS. REFER TO PAVEMENT CORES AND EXISTING TYPICAL SECTIONS.

© 2023

Texas Department of Transportation

**FM 1378
AT FM 3286
SUMMARY SHEETS
(EARTHWORK)**

SHEET 6 OF 7

DESIGN IIE	FED. RD. DIV. NO. 6	FEDERAL AID PROJECT NO. SEE TITLE SHEET		HIGHWAY NO. FM 1378, ETC.
GRAPHICS	STATE TEXAS	DISTRICT DAL	COUNTY COLLIN	SHEET NO. 19
CHECK IIE	CONTROL 1392	SECTION 01	JOB 044, ETC.	

NOTE:
ADDITIONAL QUANTITY OF PERISHABLE BMP'S IS PROVIDED
TO ALLOW FOR THEIR PERIODIC REPLACEMENT DUE TO
NORMAL WEAR OR CHANGING SITE CONDITIONS

SUMMARY OF EROSION CONTROL ITEMS FM 1378- CSJ: 1392-01-044														
LOCATION	161 6017	162 6002	164 6051	168 6001	506 6002	506 6003	506 6011	506 6020	506 6024	506 6038	506 6039	506 6041	506 6042	506 6043
	COMPOST MANUF TOPSOIL (4")	BLOCK SODDING	DRILL SEED (TEMP)(W ARM OR COOL)	VEGETATIV E WATERING	ROCK FILTER DAMS (INSTALL) (TY 2)	ROCK FILTER DAMS (INSTALL) (TY 3)	ROCK FILTER DAMS (REMOVE)	CONSTRUCT ION EXITS (INSTALL) (TY 1)	CONSTRUCT ION EXITS (REMOVE)	TEMP SEDMT CONT FENCE (INSTALL)	TEMP SEDMT CONT FENCE (REMOVE)	BIODEG EROSN CONT LOGS (INSL) (12")	BIODEG EROSN CONT LOGS (INSL) (18")	BIODEG EROSN CONT LOGS (REMOVE)
	SY	SY	SY	MG	LF	LF	LF	SY	SY	LF	LF	LF	LF	LF
PHASE 1 STAGE 1														
SHEET 1 OF 4	1065	1065	941							307		20		
SHEET 2 OF 4	3018	3018	2660							958		80		
SHEET 3 OF 4														
SHEET 4 OF 4			1277			26				977			50	
PHASE 1 STAGE 2														
SHEET 1 OF 4														
SHEET 2 OF 4	2290	2290			52							100	85	
SHEET 3 OF 4														
SHEET 4 OF 4	1891	1891	888		52	26							100	
PHASE 2 STAGE 1														
SHEET 1 OF 4	1855	1855						78		335			30	
SHEET 2 OF 4	1099	1099								432		60		
SHEET 3 OF 4														
SHEET 4 OF 4	6512	6512				52				983		40		
				3845			208		78		4391			621
10% INCREASE	1773	1773	576							399		30	26	
PROJECT TOTALS	19503	19503	6342	3845	104	104	208	78	78	4391	4391	330	291	621

SUMMARY OF EROSION CONTROL ITEMS FM 3286- CSJ: 3476-02-013												
LOCATION	161 6017	162 6002	164 6051	168 6001	506 6002	506 6003	506 6011	506 6038	506 6039	506 6041	506 6042	506 6043
	COMPOST MANUF TOPSOIL (4")	BLOCK SODDING	DRILL SEED (TEMP)(W ARM OR COOL)	VEGETATIV E WATERING	ROCK FILTER DAMS (INSTALL) (TY 2)	ROCK FILTER DAMS (INSTALL) (TY 3)	ROCK FILTER DAMS (REMOVE)	TEMP SEDMT CONT FENCE (INSTALL)	TEMP SEDMT CONT FENCE (REMOVE)	BIODEG EROSN CONT LOGS (INSL) (12")	BIODEG EROSN CONT LOGS (INSL) (18")	BIODEG EROSN CONT LOGS (REMOVE)
	SY	SY	SY	MG	LF	LF	LF	LF	LF	LF	LF	LF
PHASE 1 STAGE 1												
Sheet 2 of 4	1532	1532	1285		78	26		623		120		
sheet 3 of 4	3955	3955	1913		156	26		1617		170	20	
PHASE 1 STAGE 2												
Sheet 2 of 4	638	638	722		26					40	20	
sheet 3 of 4	4135	4135								40	40	
PHASE 2 STAGE 1												
Sheet 2 of 4	614	614									20	
sheet 3 of 4	3473	3473						1256				
				2989			312		3845			517
10% INCREASE	1434	1434	392					349		37	10	
PROJECT TOTALS	15781	15781	4312	2989	260	52	312	3845	3845	407	110	517

FILE: c:\txdot\pw\online\txdot5\ibrahim.e\isoad\0485483\Summary Sheets.dgn

TIME: 12:36:00 PM

DATE: 2/1/2023

© 2023



**FM 1378
AT FM 3286
SUMMARY SHEETS
(SW3P)**

SHEET 7 OF 7

DESIGN JI	FED. RD. DIV. NO. 6	FEDERAL AID PROJECT NO. SEE TITLE SHEET		HIGHWAY NO. FM 1378, ETC.
CHECK JI	STATE TEXAS	DISTRICT DAL	COUNTY COLLIN	20
CHECK JI	CONTROL	SECTION	JOB	
CHECK	1392	01	044, ETC.	

\$ TIME \$

\$ DATE \$

SUMMARY OF SIGNING ITEMS				
CSJ 1392-01-044	644	644	644	644
	6001	6004	6033	6036
	IN SM RD SN SUP&AM TY10BWG(1)SA(P)	IN SM RD SN SUP&AM TY10BWG(1)SA(T)	IN SM RD SN SUP&AM TYS80(1)SA(U)	IN SM RD SN SUP&AM TYS80(1)SA(U-BM)
	EA	EA	EA	EA
SHEET 1 OF 3	10	2	2	1
SHEET 2 OF 3				
SHEET 3 OF 3	7			
PROJECT TOTALS	17	2	2	1

10

SUMMARY OF SIGNING ITEMS				
CSJ 3476-02-013	644	644	644	644
	6001	6004	6033	6036
	IN SM RD SN SUP&AM TY10BWG(1)SA(P)	IN SM RD SN SUP&AM TY10BWG(1)SA(T)	IN SM RD SN SUP&AM TYS80(1)SA(U)	IN SM RD SN SUP&AM TYS80(1)SA(U-BM)
	EA	EA	EA	EA
SHEET 1 OF 3	3	2	2	
SHEET 2 OF 3	7	1		
SHEET 3 OF 3				
PROJECT TOTALS	10	3	2	

\$ FILE \$



SIGNING SUMMARY

SCALE: NTS SHEET 1 OF 1

DESIGN/CK	FED. RD. DIV. NO.	FEDERAL-AID PROJECT NUMBER		HIGHWAY NO.
MAA	6	SEE TITLE SHEET		FM 1378, ETC
CHECK	STATE	DISTRICT	COUNTY	SHEET NO.
BLS	TEXAS	DALLAS	COLLIN	21
CHECK	CONTROL	SECTION	JOB	
BA	1392	01	044, ETC	
CHECK	FRC			

BID ITEM	DESCRIPTION	UNIT	QUANTITY
416-6029	DRILL SHAFT (RDWY ILL POLE)(30 IN)	LF	8
416-6031	DRILL SHAFT (TRF SIG POLE)(30 IN)	LF	11
416-6032	DRILL SHAFT (TRF SIG POLE)(36 IN)	LF	13
416-6034	DRILL SHAFT (TRF SIG POLE)(48 IN)	LF	22
610-6050	IN RD IL (TY SA) 40T-8 (250 W EQ) LED	EA	1
618-6023	CONDT (PVC)(SCHD 40)(2")	LF	97
618-6029	CONDT (PVC)(SCHD 40)(3")	LF	206
618-6030	CONDT (PVC)(SCHD 40)(3")(BORE)	LF	393
618-6046	CONDT (PVC)(SCHD 80)(2")	LF	31
620-6004	ELEC CONDR (NO.12) INSULATED	LF	312
620-6008	ELEC CONDR (NO.8) INSULATED	LF	1166
620-6009	ELEC CONDR (NO.6) BARE	LF	655
620-6010	ELEC CONDR (NO.6) INSULATED	LF	42
624-6002	GROUND BOX TY A (122311) W/ APRON	EA	1
624-6008	GROUND BOX TY C (162911) W/ APRON	EA	5
628-6187	ELC SRV TY D (120/240) 070 (NS) SS (E) PS (U)	EA	1
636-6001	ALUMINUM SIGNS (TY A)	SF	6.25
680-6002	INSTAL OF HWY TRAF SIG (ISOLATED)	EA	1
680-6004	REMOVING TRAFFIC SIGNALS	EA	1
681-6001	TEMP TRAF SIG	EA	1
682-6001	VEH SIG SEC (12 IN) LED (GRN)	EA	4
682-6002	VEH SIG SEC (12 IN) LED (GRN ARW)	EA	4
682-6003	VEH SIG SEC (12 IN) LED (YEL)	EA	4
682-6004	VEH SIG SEC (12 IN) LED (YEL ARW)	EA	4
682-6005	VEH SIG SEC (12 IN) LED (RED)	EA	4
682-6006	VEH SIG SEC (12 IN) LED (RED ARW)	EA	4
682-6018	PED SIG SEC (LED)(COUNTDOWN)	EA	4
682-6054	BACKPLATE W/REF BRDR (3 SEC)(VENT) ALUM	EA	8
684-6031	TRAF SIG CBL (TY A)(14 AWG)(5 CONDR)	LF	454
684-6033	TRAF SIG CBL (TY A)(14 AWG)(7 CONDR)	LF	561
684-6036	TRAF SIG CBL (TY A)(14 AWG)(10 CONDR)	LF	692
684-6079	TRAF SIG CBL (TY C)(12 AWG)(2 CONDR)	LF	704
685-6005	RELOCT RDS D FLSH BCN AM (SOLAR PWRD)	EA	1
686-6031	INS TRF SIG PL AM(S) 1 ARM (28') LUM	EA	1
686-6043	INS TRF SIG PL AM(S) 1 ARM (40') LUM	EA	1
686-6067	INS TRF SIG PL AM(S) 1 ARM (65') LUM	EA	1
687-6001	PED POLE ASSEMBLY	EA	2
688-6001	PED DETECT PUSH BUTTON (APS)	EA	4
688-6003	PED DETECTOR CONTROLLER UNIT	EA	1
6058-6001	BBU SYSTEM (EXTERNAL BATT CABINET)	EA	1
6292-6003	RVDS (PRESENCE AND ADVANCE DET)	EA	3
6306-6006	VIVDS TEMPORARY	EA	1

REVISED 12-20-21



**TRAFFIC SIGNAL
SUMMARY
FM 1378 AT FM 3286**

DESIGN	FED. RD. DIV. NO.	FEDERAL AID PROJECT NO.		HIGHWAY NO.
AXR	6	(SEE TITLE SHEET)		FM 1378, ETC.
GRAPHICS	STATE	DISTRICT	COUNTY	SHEET NO.
AXR	TEXAS	18	COLLIN	22
CHECK	CONTROL	SECTION	JOB	
LDL	1392	01	044, ETC.	
CHECK	APM			

SUMMARY OF SMALL SIGNS

DISCLAIMER: The use of this standard is governed by the "Texas Engineering Practice Act". No warranty of any kind is made by TxDOT for any purpose whatsoever. TxDOT assumes no responsibility for the conversion of this standard to other formats or for incorrect results or damages resulting from its use.

DATE: DATE TIME
 FILE: DOCUMENT NAME

PLAN SHEET NO.	SIGN NO.	SIGN NOMENCLATURE * SALVAGED SIGN PANEL.	SIGN	DIMENSIONS	FLAT ALUMINUM (TYPE A)	EXAL ALUMINUM (TYPE G)	SM RD SGN ASSM TY XXXXX (X) XX (X-XXXX)				BRIDGE MOUNT CLEARANCE SIGNS (See Note 2)		
							POST TYPE	POSTS	ANCHOR TYPE	MOUNTING DESIGNATION		N TYPE	S TYPE
							FRP = Fiberglass TWT = Thin-Wall 10BWG = 10 BWG S80 = Sch 80	1 or 2	UA=Universal Conc UB=Universal Bolt SA=Slipbase-Conc SB=Slipbase-Bolt WS=Wedge Steel WP=Wedge Plastic	PREFABRICATED P = "Plain" T = "T" U = "U"	1EXT or 2EXT = # of Ext BM = Extruded Wind Beam WC = 1.12 #/ft Wing Channel EXAL= Extruded Alum Sign Panels		
1	1	R2-1		30" X 36"	X		10BWG	1	SA	P			
1	2	M3-1 M1-6F		24" X 12" 24" X 24"	X X		10BWG	1	SA	P			
		* *											
1	3	R1-1		36" X 36"	X		10BWG	1	SA	P			
1	4	W6-3		36" X 36"	X		10BWG	1	SA	P			
1	5	W6-2		36" X 36"	X		10BWG	1	SA	P			
1	6	W9-2TL		36" X 36"	X		10BWG	1	SA	P			
1	7	W6-1		36" X 36"	X		10BWG	1	SA	P			
1	8	R3-8R		36" X 36"	X		10BWG	1	SA	P			
1	9	R12-1T		24" X 36"	X		10BWG	1	SA	P			
1	10	W1-7T		96" X 36"	X		S80	1	SA	U	BM		

ALUMINUM SIGN BLANKS THICKNESS	
Square Feet	Minimum Thickness
Less than 7.5	0.080"
7.5 to 15	0.100"
Greater than 15	0.125"

The Standard Highway Sign Designs for Texas (SHSD) can be found at the following website.
<http://www.txdot.gov/>

- NOTE:**
- Sign supports shall be located as shown on the plans, except that the Engineer may shift the sign supports, within design guidelines, where necessary to secure a more desirable location or to avoid conflict with utilities. Unless otherwise shown on the plans, the Contractor shall stake and the Engineer will verify all sign support locations.
 - For installation of bridge mount clearance signs, see Bridge Mounted Clearance Sign Assembly (BMCS) Standard Sheet.
 - For Sign Support Descriptive Codes, see Sign Mounting Details Small Roadside Signs General Notes & Details SMD(GEN).



SUMMARY OF SMALL SIGNS

SOSS SHEET 1 OF 5

FILE: slums16.dgn	DN: TxDOT	CK: TxDOT	DW: TxDOT	CR: TxDOT
© TxDOT May 1987	CONT	SECT	JOB	HIGHWAY
REVISIONS	1392 01	044, ETC	FM 1378, ETC	
	DIST	COUNTY	SHEET NO.	
	DAL	COLLIN	23	

SUMMARY OF SMALL SIGNS

DISCLAIMER: The use of this standard is governed by the "Texas Engineering Practice Act". No warranty of any kind is made by TxDOT for any purpose whatsoever. TxDOT assumes no responsibility for the conversion of this standard to other formats or for incorrect results or damages resulting from its use.

DATE: DATE TIME
 FILE: DOCUMENT NAME

PLAN SHEET NO.	SIGN NO.	SIGN NOMENCLATURE * SALVAGED SIGN PANEL.	SIGN	DIMENSIONS	FLAT ALUMINUM (TYPE A)	EXAL ALUMINUM (TYPE G)	SM RD SGN ASSM TY XXXXX (X) XX (X-XXXX)				BRIDGE MOUNT CLEARANCE SIGNS (See Note 2)		
							POST TYPE	POSTS	ANCHOR TYPE	MOUNTING DESIGNATION		N	S
							FRP = Fiberglass TWT = Thin-Wall 10BWG = 10 BWG S80 = Sch 80	1 or 2	UA=Universal Conc UB=Universal Bolt SA=Slipbase-Conc SB=Slipbase-Bolt WS=Wedge Steel WP=Wedge Plastic	PREFABRICATED P = "Plain" T = "T" U = "U"	1EXT or 2EXT = # of Ext BM = Extruded Wind Beam WC = 1.12 #/ft Wing Channel EXAL= Extruded Alum Sign Panels		
1	11	M3-1		24" X 12"	X		S80	1	SA	U			
		M1-6F		24" X 24"	X								
		M6-1		21" X 15"	X								
		M3-2		24" X 12"	X								
		M1-6F		24" X 24"	X								
		M6-1		21" X 15"	X								
1	12	M3-2		24" X 12"	X		S80	1	SA	U			
		M1-6F		24" X 24"	X								
		M6-1		21" X 15"	X								
		M3-1		24" X 12"	X								
		M1-6F		24" X 24"	X								
		M6-3		21" X 15"	X								
1	13	R1-1		36" X 36"	X		10BWG	1	SA	P			
		R3-8 LLS		48" X 30"	X						10BWG	1	SA
1	15	M3-2		24" X 12"	X		S80	1	SA	U			
		M1-6F		24" X 24"	X								
		M6-3		21" X 15"	X								
		M3-3		24" X 12"	X								
		M1-6F		24" X 24"	X								
		M6-1		21" X 15"	X								

ALUMINUM SIGN BLANKS THICKNESS	
Square Feet	Minimum Thickness
Less than 7.5	0.080"
7.5 to 15	0.100"
Greater than 15	0.125"

The Standard Highway Sign Designs for Texas (SHSD) can be found at the following website:
<http://www.txdot.gov/>

- NOTE:**
- Sign supports shall be located as shown on the plans, except that the Engineer may shift the sign supports, within design guidelines, where necessary to secure a more desirable location or to avoid conflict with utilities. Unless otherwise shown on the plans, the Contractor shall stake and the Engineer will verify all sign support locations.
 - For installation of bridge mount clearance signs, see Bridge Mounted Clearance Sign Assembly (BMCS) Standard Sheet.
 - For Sign Support Descriptive Codes, see Sign Mounting Details Small Roadside Signs General Notes & Details SMD(GEN).



SUMMARY OF SMALL SIGNS











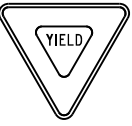
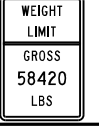

SOSS SHEET 2 OF 5

FILE: slums16.dgn	DN: TxDOT	CK: TxDOT	DW: TxDOT	CR: TxDOT
© TxDOT May 1987	CONT	SECT	JOB	HIGHWAY
REVISIONS	1392 01	044,	ETC	FM 1378, ETC
	DIST	COUNTY	SHEET NO.	
	DAL	COLLIN	24	

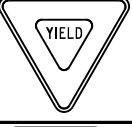
SUMMARY OF SMALL SIGNS

DISCLAIMER: The use of this standard is governed by the "Texas Engineering Practice Act". No warranty of any kind is made by TxDOT for any purpose whatsoever. TxDOT assumes no responsibility for the conversion of this standard to other formats or for incorrect results or damages resulting from its use.

DATE: DATE TIME
 FILE: DOCUMENT NAME

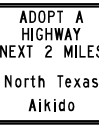
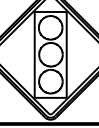
PLAN SHEET NO.	SIGN NO.	SIGN NOMENCLATURE * SALVAGED SIGN PANEL.	SIGN	DIMENSIONS	FLAT ALUMINUM (TYPE A)	EXAL ALUMINUM (TYPE G)	SM RD SGN ASSM TY XXXXX (X) XX (X-XXXX)				BRIDGE MOUNT CLEARANCE SIGNS (See Note 2)		
							POST TYPE	POSTS	ANCHOR TYPE	MOUNTING DESIGNATION		N TYPE	S TYPE
							FRP = Fiberglass TWT = Thin-Wall 10BWG = 10 BWG S80 = Sch 80	1 or 2	UA=Universal Conc UB=Universal Bolt SA=Slipbase-Conc SB=Slipbase-Bolt WS=Wedge Steel WP=Wedge Plastic	PREFABRICATED P = "Plain" T = "T" U = "U"	1EXT or 2EXT = # of Ext BM = Extruded Wind Beam WC = 1.12 #/ft Wing Channel EXAL= Extruded Alum Sign Panels		
1	16	R1-2		48" X 48" X 48"	X		10BWG	1	SA	T			
1	17	R12-1T		24" X 36"	X		10BWG	1	SA	P			
1	18	M3-1		24" X 12"	X	} S80							
		M1-6F		24" X 24"	X								
		M6-1		21" X 15"	X			S80	1	SA	U		
		M3-2		24" X 12"	X								
		M1-6F		24" X 24"	X								
		M6-1		21" X 15"	X								
1	19	R1-2		48" X 48" X 48"	X		10BWG	1	SA	T			
1	20	M3-2		24" X 12"	X	} MOUNT D10-7aT SIGN PANELS BACK TO BACK							
		M1-6F		24" X 24"	X			10BWG	1	SA	P		
		D10-7aT		3" X 10"	X								
		D10-7aT		3" X 10"	X								
1	21	W9-1R		36" X 36"	X		10BWG	1	SA	P			
1	22	D14-4T		48" X 48"	X		10BWG	1	SA	T			
2	1	W3-3		36" X 36"	X		10BWG	1	SA	P			

ALUMINUM SIGN BLANKS THICKNESS	
Square Feet	Minimum Thickness
Less than 7.5	0.080"
7.5 to 15	0.100"
Greater than 15	0.125"

The Standard Highway Sign Designs for Texas (SHSD) can be found at the following website:
<http://www.txdot.gov/>

- NOTE:**
- Sign supports shall be located as shown on the plans, except that the Engineer may shift the sign supports, within design guidelines, where necessary to secure a more desirable location or to avoid conflict with utilities. Unless otherwise shown on the plans, the Contractor shall stake and the Engineer will verify all sign support locations.
 - For installation of bridge mount clearance signs, see Bridge Mounted Clearance Sign Assembly (BMCS) Standard Sheet.
 - For Sign Support Descriptive Codes, see Sign Mounting Details Small Roadside Signs General Notes & Details SMD(GEN).



SUMMARY OF SMALL SIGNS

SOSS SHEET 3 OF 5

FILE: slums16.dgn	DN: TxDOT	CK: TxDOT	DW: TxDOT	CR: TxDOT
© TxDOT May 1987	CONT	SECT	JOB	HIGHWAY
REVISIONS	1392 01	044, ETC	FM 1378, ETC	
	DIST	COUNTY	SHEET NO.	
	DAL	COLLIN	25	

SUMMARY OF SMALL SIGNS

DISCLAIMER: The use of this standard is governed by the "Texas Engineering Practice Act". No warranty of any kind is made by TxDOT for any purpose whatsoever. TxDOT assumes no responsibility for the conversion of this standard to other formats or for incorrect results or damages resulting from its use.

DATE: DATE TIME
 FILE: DOCUMENT NAME

PLAN SHEET NO.	SIGN NO.	SIGN NOMENCLATURE * SALVAGED SIGN PANEL.	SIGN	DIMENSIONS	FLAT ALUMINUM (TYPE A)	EXAL ALUMINUM (TYPE G)	SM RD SGN ASSM TY XXXXX (X) XX (X-XXXX)				BRIDGE MOUNT CLEARANCE SIGNS (See Note 2)		
							POST TYPE	POSTS	ANCHOR TYPE	MOUNTING DESIGNATION		N TYPE	S TYPE
							FRP = Fiberglass TWT = Thin-Wall 10BWG = 10 BWG S80 = Sch 80	1 or 2	UA=Universal Conc UB=Universal Bolt SA=Slipbase-Conc SB=Slipbase-Bolt WS=Wedge Steel WP=Wedge Plastic	PREFABRICATED P = "Plain" T = "T" U = "U"	1EXT or 2EXT = # of Ext BM = Extruded Wind Beam WC = 1.12 #/ft Wing Channel EXAL= Extruded Alum Sign Panels		
		* *	IL E. Lucas Rd IL Lost Valley Dr										
2	2	R1-1		36" X 36"	X		10BWG	1	SA	P			
2	3	M2-1 M1-6F		24" X 12" 24" X 24"	X X		10BWG	1	SA	P			
2	4	W9-2TL		36" X 36"	X		10BWG	1	SA	P			
2	5	R2-1		30" X 36"	X		10BWG	1	SA	P			
		* *	IL Hob Hill Ln IL E. Lucas Rd										
2	6	R1-1		36" X 36"	X		10BWG	1	SA	P			
2	7	W2-1aT		48" X 48"	X		10BWG	1	SA	T			
		* *	IL Winding Creek Dr IL E. Lucas Rd										
2	8	R1-1		36" X 36"	X		10BWG	1	SA	P			
3	1	M3-1 M1-6F		24" X 12" 24" X 24"	X X		10BWG	1	SA	P			
		M5-1L		21" X 15"	X								

ALUMINUM SIGN BLANKS THICKNESS	
Square Feet	Minimum Thickness
Less than 7.5	0.080"
7.5 to 15	0.100"
Greater than 15	0.125"

The Standard Highway Sign Designs for Texas (SHSD) can be found at the following website:
<http://www.txdot.gov/>

- NOTE:**
- Sign supports shall be located as shown on the plans, except that the Engineer may shift the sign supports, within design guidelines, where necessary to secure a more desirable location or to avoid conflict with utilities. Unless otherwise shown on the plans, the Contractor shall stake and the Engineer will verify all sign support locations.
 - For installation of bridge mount clearance signs, see Bridge Mounted Clearance Sign Assembly (BMCS) Standard Sheet.
 - For Sign Support Descriptive Codes, see Sign Mounting Details Small Roadside Signs General Notes & Details SMD(GEN).









SUMMARY OF SMALL SIGNS

SOSS SHEET 4 OF 5

FILE: slums16.dgn	DN: TxDOT	CK: TxDOT	DW: TxDOT	CR: TxDOT
© TxDOT May 1987	CONT	SECT	JOB	HIGHWAY
REVISIONS	1392 01	044, ETC	FM 1378, ETC	
	DIST	COUNTY	SHEET NO.	
	DAL	COLLIN	26	

SUMMARY OF SMALL SIGNS

DISCLAIMER: The use of this standard is governed by the "Texas Engineering Practice Act". No warranty of any kind is made by TxDOT for any purpose whatsoever. TxDOT assumes no responsibility for the conversion of this standard to other formats or for incorrect results or damages resulting from its use.

PLAN SHEET NO.	SIGN NO.	SIGN NOMENCLATURE * SALVAGED SIGN PANEL.	SIGN	DIMENSIONS	FLAT ALUMINUM (TYPE A)	EXAL ALUMINUM (TYPE G)	SM RD SGN ASSM TY XXXXX (X) XX (X-XXXX)				BRIDGE MOUNT CLEARANCE SIGNS (See Note 2)		
							POST TYPE	POSTS	ANCHOR TYPE	MOUNTING DESIGNATION		N TYPE	S TYPE
							FRP = Fiberglass TWT = Thin-Wall 10BWG = 10 BWG S80 = Sch 80	1 or 2	UA=Universal Conc UB=Universal Bolt SA=Slipbase-Conc SB=Slipbase-Bolt WS=Wedge Steel WP=Wedge Plastic	PREFABRICATED P = "Plain" T = "T" U = "U"	1EXT or 2EXT = # of Ext BM = Extruded Wind Beam WC = 1.12 #/ft Wing Channel EXAL= Extruded Alum Sign Panels		
		* *	IL Arthur ct IL Southview Dr										
3	2	R1-1		36" X 36"	X		10BWG	1	SA	P			
3	3	R2-1		30" X 36"	X		10BWG	1	SA	P			
		* *	IL Prado Verde Dr IL Southview Dr										
3	4	R1-1		36" X 36"	X		10BWG	1	SA	P			
3	5	W9-2TL		36" X 36"	X		10BWG	1	SA	P			
3	6	M3-3		24" X 12"	X		10BWG	1	SA	P			
		M1-6F		24" X 24"	X								
		* *	IL Carey Ln IL Southview Dr										
3	8	R1-1		36" X 36"	X		10BWG	1	SA	P			

ALUMINUM SIGN BLANKS THICKNESS	
Square Feet	Minimum Thickness
Less than 7.5	0.080"
7.5 to 15	0.100"
Greater than 15	0.125"

The Standard Highway Sign Designs for Texas (SHSD) can be found at the following website.
<http://www.txdot.gov/>

- NOTE:**
- Sign supports shall be located as shown on the plans, except that the Engineer may shift the sign supports, within design guidelines, where necessary to secure a more desirable location or to avoid conflict with utilities. Unless otherwise shown on the plans, the Contractor shall stake and the Engineer will verify all sign support locations.
 - For installation of bridge mount clearance signs, see Bridge Mounted Clearance Sign Assembly (BMCS) Standard Sheet.
 - For Sign Support Descriptive Codes, see Sign Mounting Details Small Roadside Signs General Notes & Details SMD(GEN).



SUMMARY OF SMALL SIGNS

SOSS SHEET 5 OF 5

FILE: slms16.dgn	DN: TxDOT	CK: TxDOT	DW: TxDOT	CR: TxDOT
© TxDOT May 1987	CONT	SECT	JOB	HIGHWAY
REVISIONS	1392	01	044, ETC FM 1378, ETC	
DIST	COUNTY	SHEET NO.		
DAL	COLLIN	27		

DATE: DATE TIME
 FILE: DOCUMENT NAME

FM 1378 (W LUCAS RD) AT FM 3286 (E LUCAS RD)

General:

-The contractor will not have exclusive use of the right-of-way but shall cooperate in the use of the right-of-way with TXDOT, other public utility companies, their contractors, and other TXDOT roadway contractors as may be required to allow for utility adjustments and road construction. All detours, horizontal traffic movements, temporary CTB, illumination system, drainage, etc. are directly related to the sequence of operations in conformity with the details shown on the plans. The contractors must ensure adequate drainage during all phases of construction. All traffic control activities shall be coordinated with operations such as utility relocations, SW3P, drainage and bridge structures, etc. traffic must be handled over the entire project during construction.

Phase 1:

Stage 1-A:

- Initiate SW3P & TCP. Before this stage, add detour pavement on the existing WBML of FM 1378 starting at Sta. 10+00 and match the newly constructed proposed WBML of FM 1378 pavement at Sta. 19+00.
- Traffic will remain on the existing pavement during the duration of this first stage of this phase.
- Construct the proposed concrete WBML from Sta. 19+01 to 35+72 (FM 1378/FM 3286).
- Construct proposed asphalt WBML from Sta. 35+72 to 45+63 (FM 3286).
- Construct the proposed concrete EBML from Sta. 20+52 to 23+11 (FM 1378).
- Construct the proposed concrete NBML and SBML from Sta. 110+00 to 110+81 (FM 1378).
- Add detour pavement on the newly constructed proposed WBML of FM 3286 starting at Sta. 37+50 and match the existing WBML of FM 3286 at Sta. 49+74.
- Add detour pavement on the existing NBML of FM 1378 starting beyond the end of the project at Sta. 91+27 and match the existing NBML of FM 1378 at Sta. 103+73.
- Add detour pavement on the existing NBML of FM 1378 starting at Sta. 106+59 and match the existing EBML of FM 3286 pavement at Sta. 109+01.
- Add detour pavement on the existing WBML of FM 3286 starting at Sta. 109+52 and match the newly constructed proposed NBML of FM 1378 pavement at Sta. 110+00.
- Add detour pavement on the existing EBML of FM 3286 starting at Sta. 26+45 and match the existing EBML of FM 3286 at Sta. 32+14.
- Add detour pavement on the existing EBML of FM 3286 starting at Sta. 32+41 and match the existing EBML of FM 3286 at Sta. 35+40.

NTMWD Waterline Relocation:

- The contractor must complete all work detailed in phase 1 Stage 1-A prior to beginning the waterline relocations for NTMWD.
- Easements need to be secured for waterline relocation.
- The existing waterline will need to be shutdown and connected into proposed, NTMWD shutdown season from October to April, no water shutdown allowed outside these time limits.
- Take extreme care while constructing the proposed 20' line adjacent to the private property (dwelling) at the south end of the construction.

Stage 1-B:

- Construct the proposed asphalt EBML from Sta. 12+25 to 16+16 (FM 1378) outside the existing roadway.
- Construct the proposed concrete EBML from Sta. 16+16 to Sta. 18+00 (FM 1378).
- Add detour pavement on the existing EBML of FM 1378 starting at Sta. 18+00 and match the existing EBML of FM 1378 at Sta. 19+52.

Stage 1-C:

- Construct remaining proposed asphalt EBML (near centerline) from Sta. 13+45 to Sta. 16+16 of FM 1378.

Stage 2:

- Initiate SW3P & TCP. Northbound and southbound main lane traffic along Southview Rd (FM 1378) will transition to the detour pavement from Sta. 90+95 to Sta. 103+71, where traffic will be transitioned back to the existing pavement and the NBML from Sta. 106+58 to the intersection between Lucas Rd and Southview Rd. Eastbound and westbound main lane traffic will be on the detour pavement on W Lucas Rd from Sta. 10+00 to Sta. 19+01, where traffic will be transitioned to the proposed WBML from Sta. 19+01, through the intersection, to Sta. 37+50 where the traffic will be transitioned to the detour pavement along E Lucas Rd (FM 3286) until returned to the existing pavement at Sta. 49+56.
- Add detour pavement on the existing NBML of FM 1378, matching previous proposed detour, starting at Sta. 108+13 and match the existing EBML of FM 3286 pavement at Sta. 109+23.
- Construct the proposed concrete EBML from Sta. 18+00 to Sta. 20+52 (FM 1378).
- Construct the proposed concrete EBML and median from Sta. 22+56 to Sta. 35+73 (FM3286).
- Construct the proposed concrete SBML from Sta. 106+15 to 110+00 (FM 1378).
- Construct the proposed asphalt SBML from Sta. 94+86 to 106+15 (FM 1378) and the proposed asphalt EBML from Sta. 35+72 to 45+63 (FM 3286).
- Add detour pavement on the newly constructed EBML of FM 1378 starting at Sta. 18+00 and match the newly constructed EBML of FM 1378 at Sta. 21+50.
- Add detour pavement on the newly constructed SBML of FM 1378 starting at Sta. 91+04 and match the newly constructed SBML of FM 1378 at Sta. 100+95.

Phase 2:

Stage 1:

- Initiate SW3P & TCP. Northbound and southbound main lane traffic along Southview Rd (FM 1378) will shift onto the detour pavement, proposed SBML and the existing SBML (until there is enough width of proposed SBML for both directions of travel) from Sta. 90+95 to the intersection with Lucas Rd. Eastbound and westbound main lane traffic on FM 1378 will be on the proposed pavement on W Lucas Rd from Sta. 12+25 to the intersection. Eastbound and westbound on FM 3286, will remain on the proposed WBML from the intersection to Sta. 35+72 where the traffic will shift onto the EBML and WBML proposed pavement.
- Construct the proposed asphalt WBML from Sta. 13+45 to 16+16 (FM 1378) and the proposed asphalt NBML from Sta. 94+86 to 106+15 (FM 1378).
- Construct the proposed WBML from Sta. 16+16 to Sta. 19+01.
- Construct the proposed concrete NBML from 106+15 to 110+00 and right turn channelized island at the intersection of Southview Rd and Lucas Rd.

Stage 2:

- Initiate SW3P & TCP. Main lanes traffic will be on the proposed WBML and EBML on Lucas Rd. as well as NBML and SBML on Southview Rd.
- Construct the median from Sta. 16+16 to the intersection of Southview Rd and Lucas Rd.
- Re-stabilize disturbed land and remove temporary SW3P devices. Remove detour pavement.
- Final project clean up and punch list.

Notes:

- 1) Provide shadow vehicles equipped with truck mounted attenuator as shown on standards TCP (2-1)-18 to TCP (2-6)-18. Quantity may be added per standards or as directed by Engineer.
- 2) Work zone posted speed limits will 45 mph for FM 1378 (including Southview Rd.) and FM 3286.
- 3) Refer to the (BC) standards, work zone standards, and the current Texas Manual on Uniform Traffic Control Devices (TMUCD) for details regarding traffic control markings and devices used in the phase construction.
- 4) Erect all advance warning signs and traffic devices according to the BC standards, TCP standards, and as directed.
- 5) Maintain all advance warning signs and traffic devices from previous construction phases until they are no longer needed. This will be done according to the BC standards, TCP standards, and as directed.
- 6) Cover existing and/or proposed signs when necessary to reflect the traffic detours during construction. This work will be considered subsidiary to item 502.
- 7) Contractor shall determine the exact location of all existing utilities before commencing work. The contractor is fully responsible for all utility damages which resulted from contractor's failure to locate and preserve any above ground and underground utility.
- 8) See Traffic Control Miscellaneous Details Sheet for phased construction of the cross streets and driveways.
- 9) Temporary SW3P erosion control measures shall only be placed in areas where soil disturbance is expected to occur within two weeks.
- 10) Temporary SW3P erosion control measures shall be removed in area within two weeks of vegetation establishment or as approved by Engineer.
- 11) Contractor shall be responsible for removing all conflicting existing and work zone pavement markings, including pavement markings not specifically called out to be removed on the plans.
- 12) Place Portable Changeable Message Signs at each end of the project limits at least one week in advance of all major traffic shifts.

FILE: c:\txdot\pw\onl\ine\txdot\5\ibrahim.eisaad\0326854\TCP Narrat.ive.dgn

TIME: 9:17:14 AM

DATE: 4/6/2023

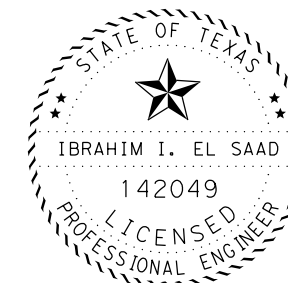

Ibrahim El Saad, P.E. 4-6-23
Signature of Registrant & Date

			
FM 1378 AT FM 3286 TRAFFIC CONTROL PLAN NARRATIVE			
SHEET 1 OF 1			
DESIGN	FED. RD. DIV. NO.	FEDERAL AID PROJECT NO.	HIGHWAY NO.
IIE	6	SEE TITLE SHEET	FM 1378, ETC.
GRAPHICS	STATE	DISTRICT	COUNTY
IIE	TEXAS	DAL	COLLIN
CHECK	CONTROL	SECTION	JOB
CHECK	1392	01	044, ETC.
			28

FILE: c:\txdot\pw\onl\ine\txdot5\ibrahim.elsaad\d0326854\TCP Typical Sections Sheets P1S1-A.dgn

DATE: 2/28/2023 TIME: 2:16:13 PM

DATE: 2/28/2023

LEGEND

- PERMANENT CONSTRUCTION THIS PHASE
- PERMANENT CONSTRUCTION PREVIOUS PHASE
- ▬ DETOUR PAVEMENT
- Ⓐ - 2" SUPERPAVE MIXTURES (SP-C) (PG64-22)
- Ⓑ - 4" SUPERPAVE MIXTURES (SP-B) (PG64-22)
- Ⓒ - 8" LTS WITH 5% LIME (EXIST)

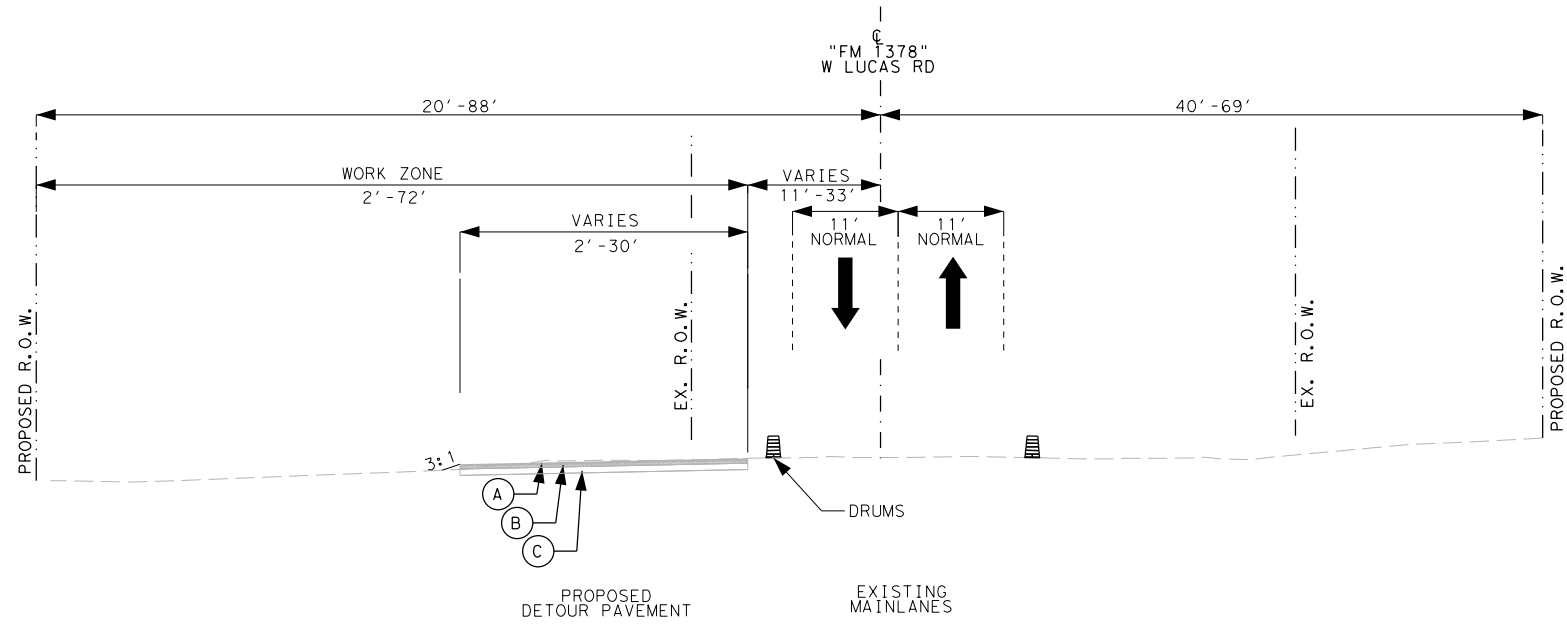

TCP PHASE 1 STAGE 1-A FM 1378 TYPICAL SECTION
 @ "FM 1378" W LUCAS RD STA. 10+00 TO STA. 19+01

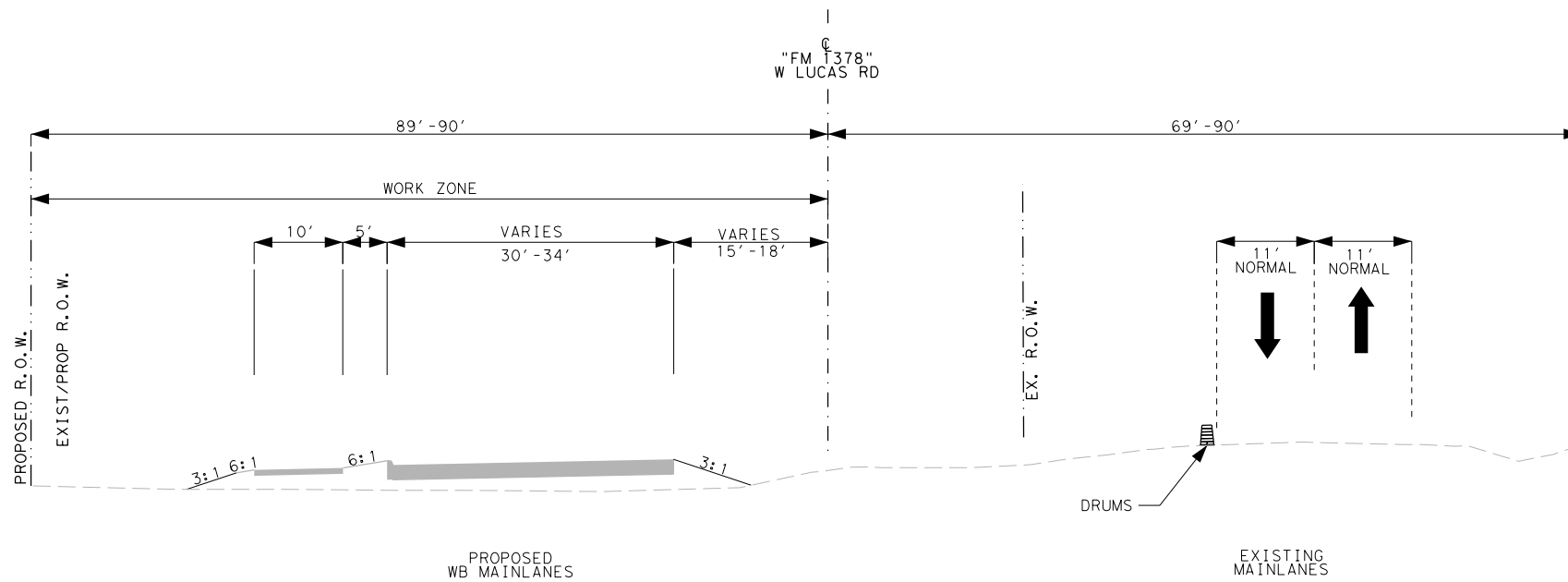

TCP PHASE 1 STAGE 1-A FM 1378 TYPICAL SECTION
 @ "FM 1378" W LUCAS RD STA. 19+01 TO STA. 20+52

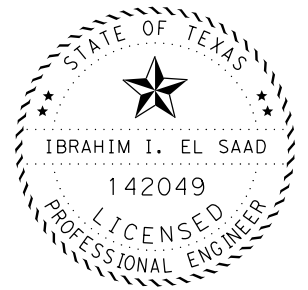

Ibrahim I. Saad, P.E. 2-28-23
 Signature of Registrant & Date



FM 1378
 AT FM 3286
TRAFFIC CONTROL PLAN
PHASE 1 STAGE 1-A
TYPICAL SECTION

SHEET 1 OF 4

DESIGN IIE	FED. RD. DIV. NO. 6	FEDERAL AID PROJECT NO. SEE TITLE SHEET		HIGHWAY NO. FM 1378, ETC.
GRAPHICS IIE	STATE TEXAS	DISTRICT DAL	COUNTY COLLIN	SHEET NO. 29
CHECK JI	CONTROL 1392	SECTION 01	JOB 044, ETC.	

DATE: 2/16/2023 TIME: 10:49:55 AM FILE: c:\txdot\pw\online\txdot5\ibrahim.elsaad\0326854\TCP Typical Sections Sheets P1S1-A.dgn

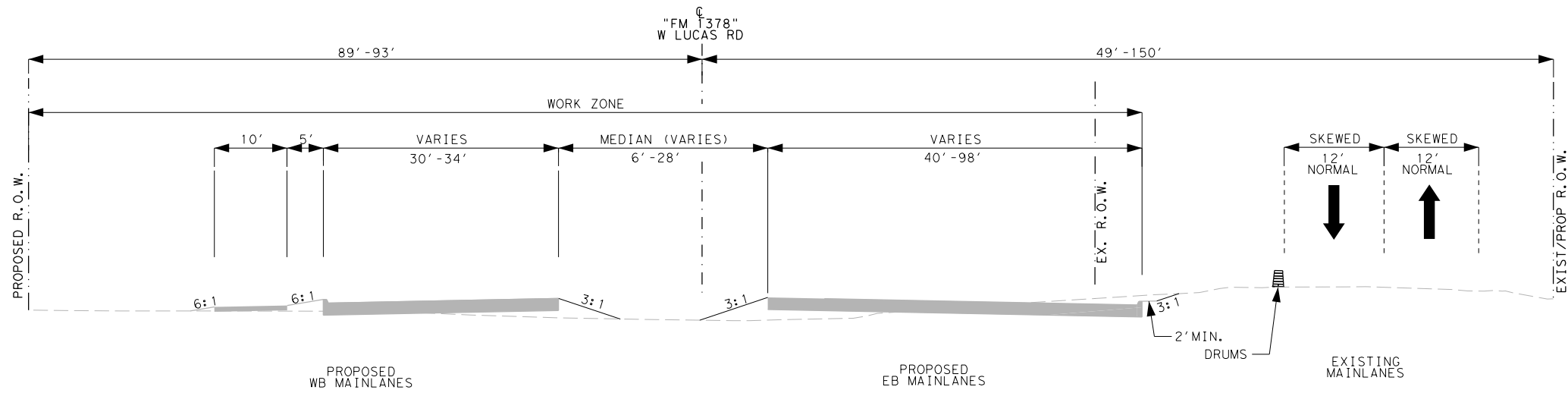

TCP PHASE 1 STAGE 1-A FM 1378 TYPICAL SECTION
 @ "FM 1378" W LUCAS RD STA. 20+52 TO STA. 23+11

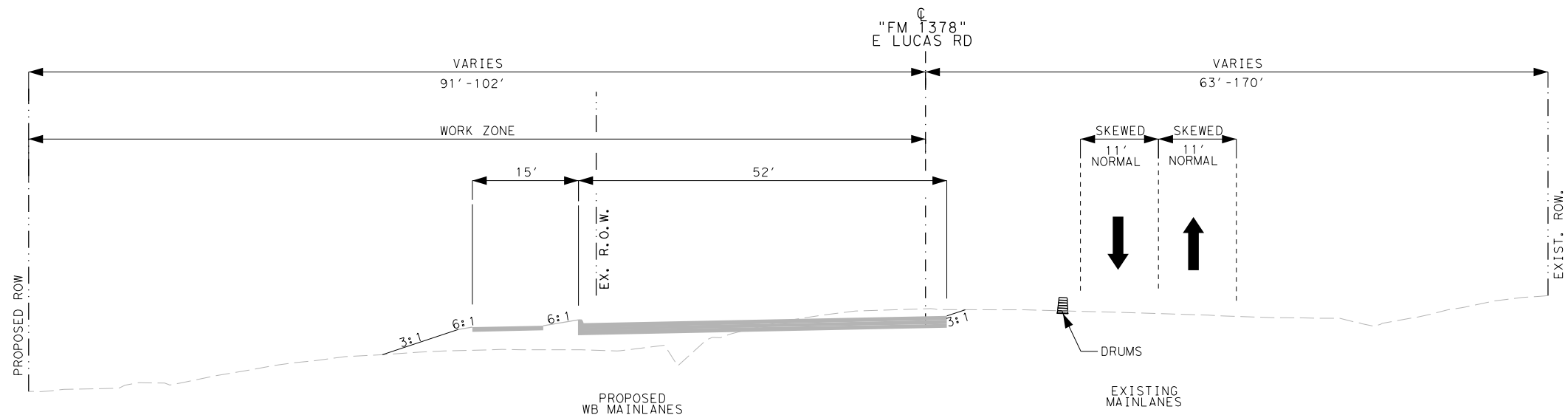

TCP PHASE 1 STAGE 1-A FM 3286 TYPICAL SECTION
 @ "FM 1378" E LUCAS RD - STA. 23+11 TO STA. 24+34

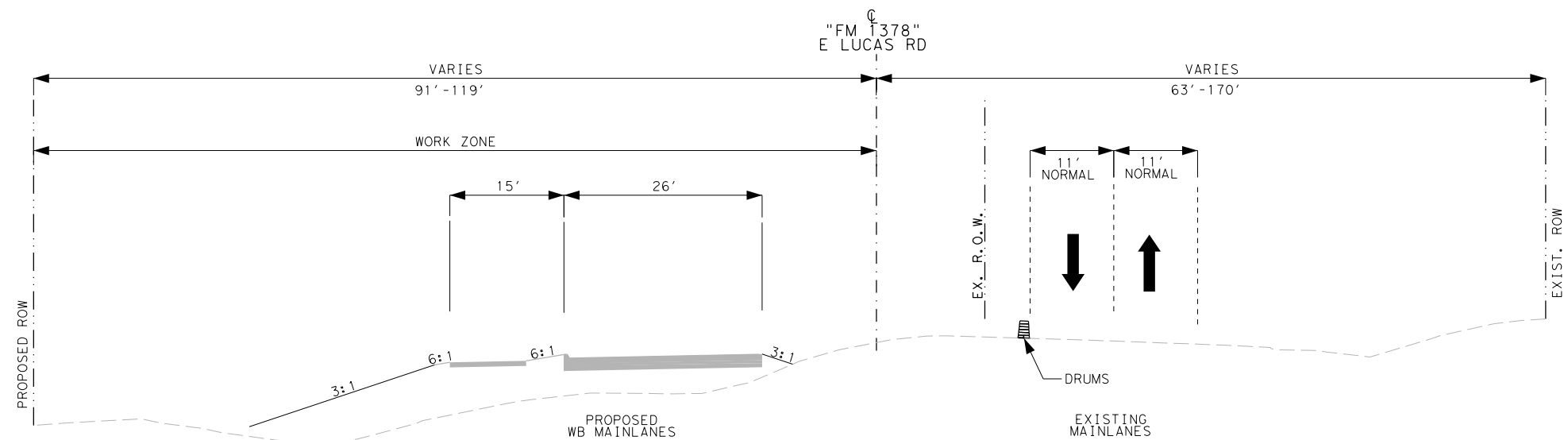

TCP PHASE 1 STAGE 1-A FM 3286 TYPICAL SECTION
 @ "FM 1378" E LUCAS RD - STA. 24+34 TO STA. 25+73

LEGEND

- PERMANENT CONSTRUCTION THIS PHASE
- PERMANENT CONSTRUCTION PREVIOUS PHASE
- DETOUR PAVEMENT
- (A) - 2" SUPERPAVE MIXTURES (SP-C) (PG64-22)
- (B) - 4" SUPERPAVE MIXTURES (SP-B) (PG64-22)
- (C) - 8" LTS WITH 5% LIME (EXIST)

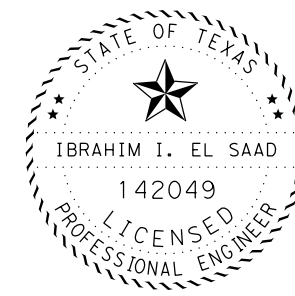

Abraham El Saad, P.E. 2-16-23
 Signature of Registrant & Date



FM 1378
 AT FM 3286
TRAFFIC CONTROL PLAN
PHASE 1 STAGE 1-A
TYPICAL SECTION

SHEET 2 OF 4

DESIGN IIE	FED. RD. DIV. NO. 6	FEDERAL AID PROJECT NO. SEE TITLE SHEET		HIGHWAY NO. FM 1378, ETC.
GRAPHICS IIE	STATE TEXAS	DISTRICT DAL	COUNTY COLLIN	SHEET NO. 30
CHECK JI	CONTROL 1392	SECTION 01	JOB 044, ETC.	

DATE: 2/16/2023 TIME: 10:49:56 AM FILE: c:\txdot\pwworking\ibrahim.elsaad\0326854\TCP Typical Sections Sheets P1S1-A.dgn

- LEGEND**
- PERMANENT CONSTRUCTION THIS PHASE
 - PERMANENT CONSTRUCTION PREVIOUS PHASE
 - ▬ DETOUR PAVEMENT
 - Ⓐ - 2" SUPERPAVE MIXTURES (SP-C) (PG64-22)
 - Ⓑ - 4" SUPERPAVE MIXTURES (SP-B) (PG64-22)
 - Ⓒ - 8" LTS WITH 5% LIME (EXIST)

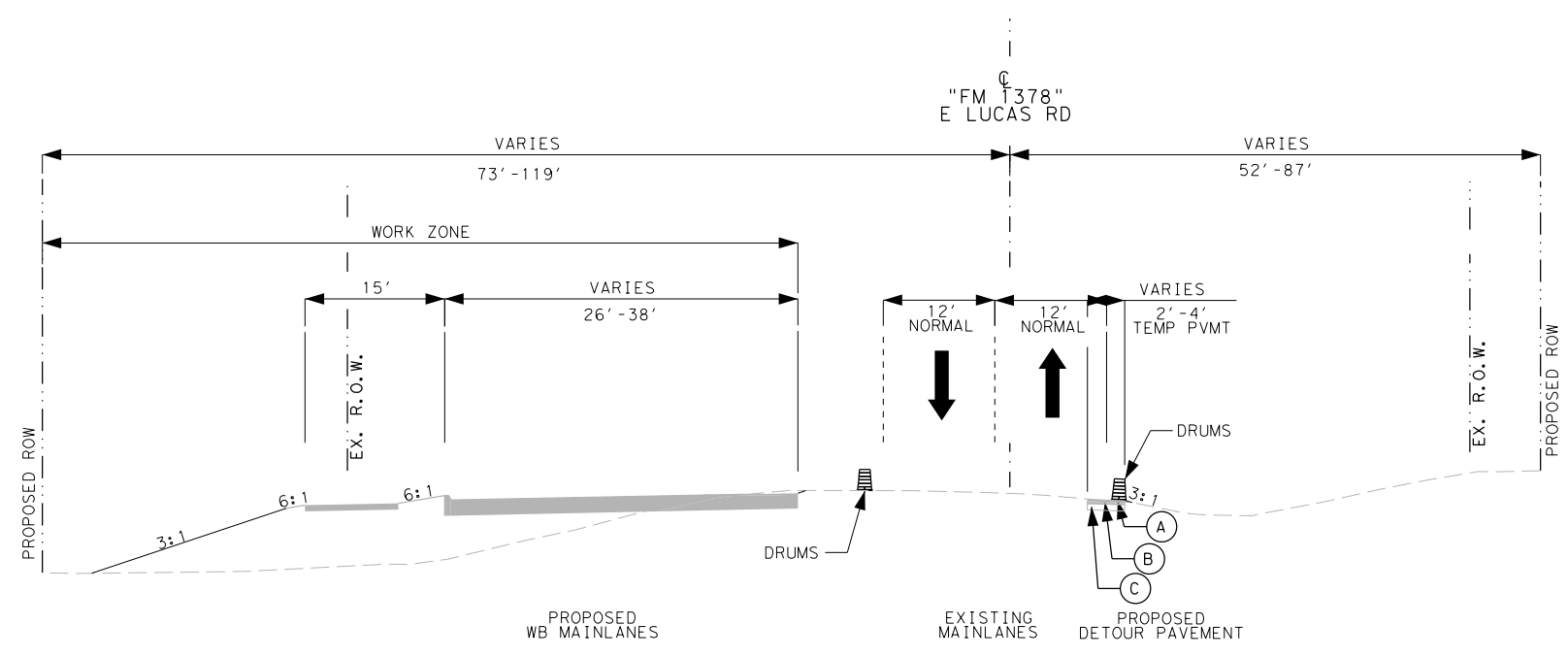

TCP PHASE 1 STAGE 1-A FM 3286 TYPICAL SECTION
 @ "FM 1378" E LUCAS RD - STA. 25+73 TO STA. 34+23

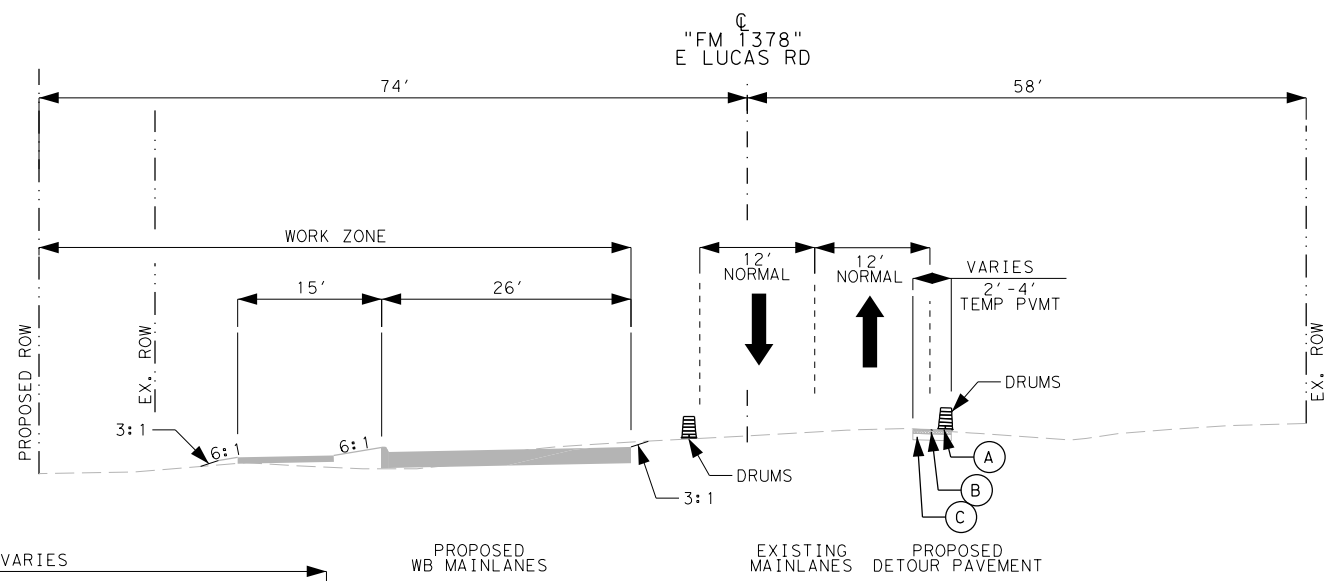

TCP PHASE 1 STAGE 1-A FM 3286 TYPICAL SECTION
 @ "FM 1378" E LUCAS RD - STA. 34+23 TO STA. 35+72

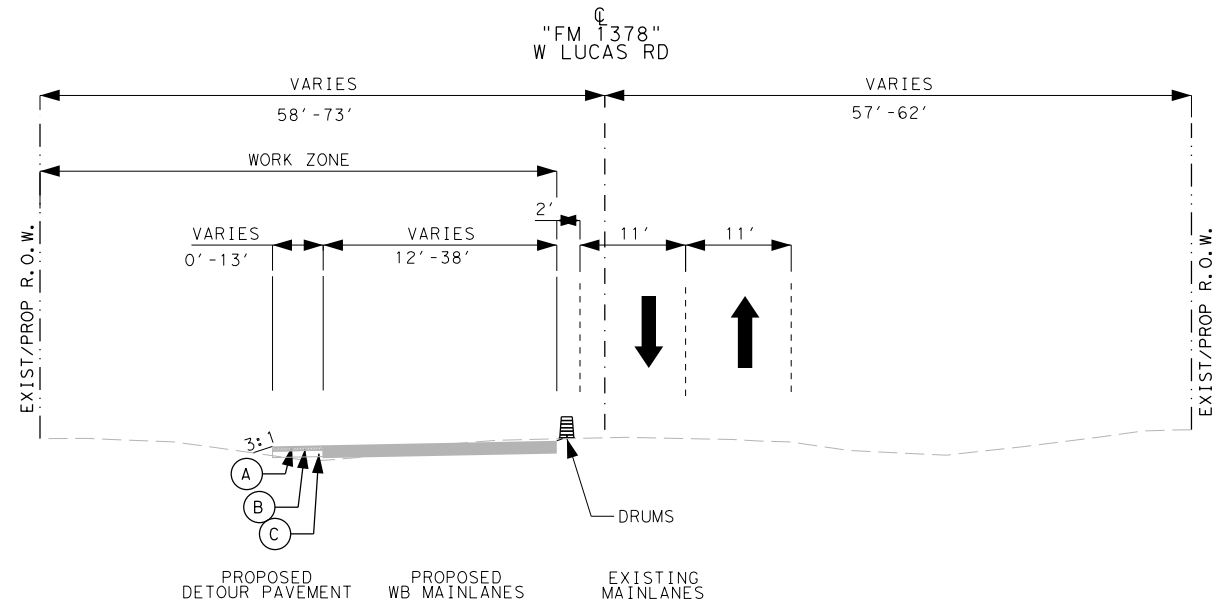

TCP PHASE 1 STAGE 1-A FM 3286 TYPICAL SECTION
 @ "FM 1378" E LUCAS RD - STA. 35+72 TO STA. 45+63

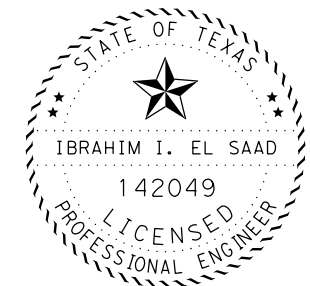

Abraham El Saad, P.E. 2-16-23
 Signature of Registrant & Date



FM 1378
 AT FM 3286
TRAFFIC CONTROL PLAN
PHASE 1 STAGE 1-A
TYPICAL SECTION

SHEET 3 OF 4

DESIGN	FED. RD. DIV. NO.	FEDERAL AID PROJECT NO.		HIGHWAY NO.
GRAPHICS	6	SEE TITLE SHEET		FM 1378, ETC.
IE	STATE	DISTRICT	COUNTY	SHEET NO.
CHECK	TEXAS	DAL	COLLIN	31
J1	CONTROL	SECTION	JOB	
CHECK	1392	01	044, ETC.	

DATE: 2/16/2023 TIME: 10:49:58 AM FILE: c:\txdot\pw\online\txdot5\ibrahim.elsaad\0326854\TCP Typical Sections Sheets P1S1-A.dgn

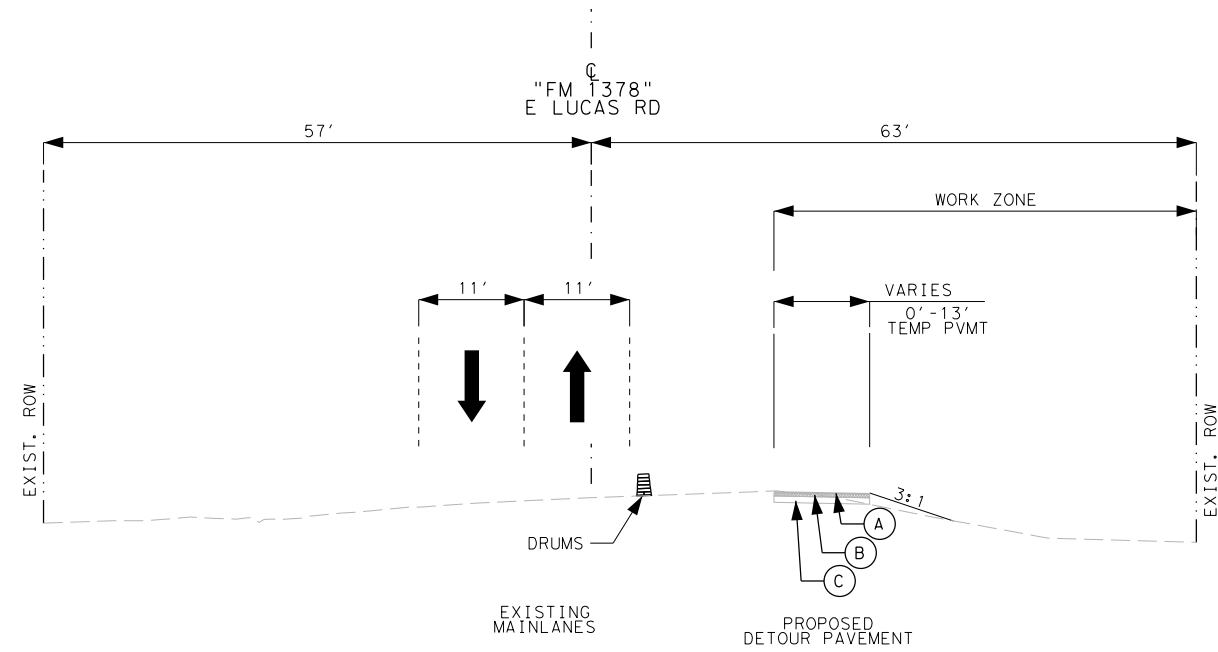

TCP PHASE 1 STAGE 1-A FM 3286 TYPICAL SECTION
 @ "FM 1378" E LUCAS RD - STA. 45+63 TO STA. 49+74

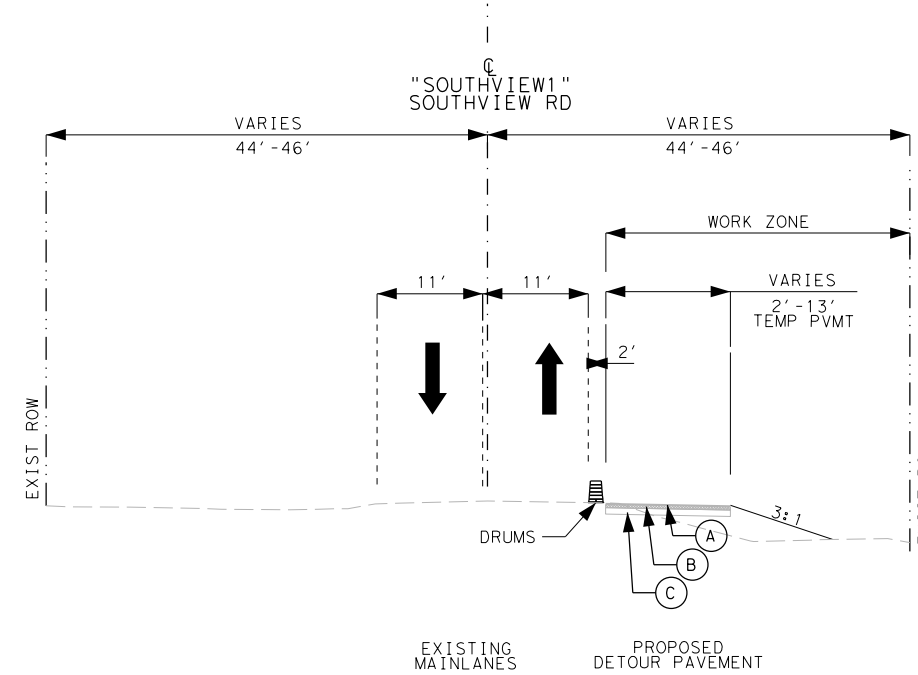

TCP PHASE 1 STAGE 1-A FM 1378 TYPICAL SECTION
 @ "SOUTHVIEW1" SOUTHVIEW RD - STA. 91+27.50 TO STA. 103+73

LEGEND

- PERMANENT CONSTRUCTION THIS PHASE
- PERMANENT CONSTRUCTION PREVIOUS PHASE
- DETOUR PAVEMENT
- A - 2" SUPERPAVE MIXTURES (SP-C) (PG64-22)
- B - 4" SUPERPAVE MIXTURES (SP-B) (PG64-22)
- C - 8" LTS WITH 5% LIME (EXIST)

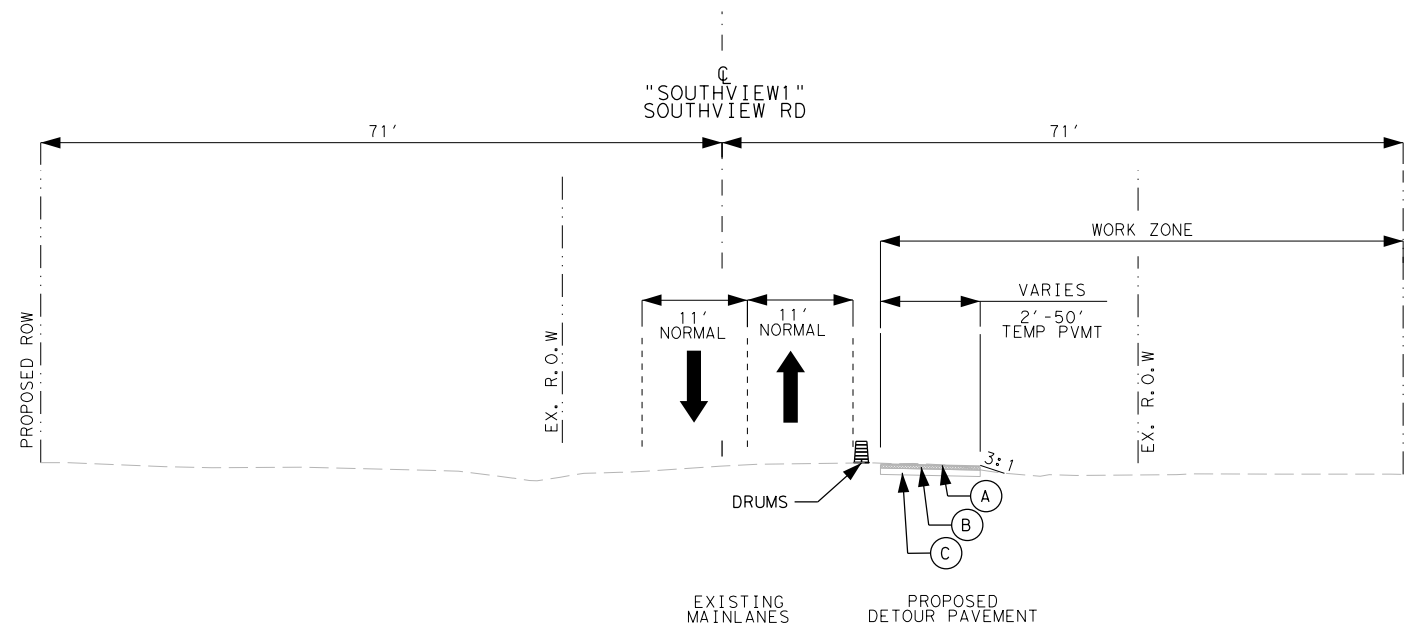

TCP PHASE 1 STAGE 1-A FM 1378 TYPICAL SECTION
 @ "SOUTHVIEW1" SOUTHVIEW RD - STA. 106+58 TO STA. 110+00

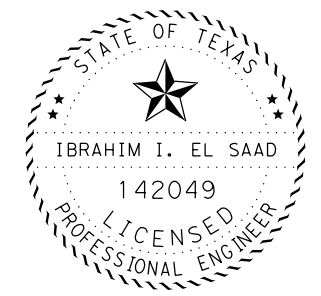

Abraham El Saad, P.E. 2-16-23
 Signature of Registrant & Date



FM 1378
 AT FM 3286
TRAFFIC CONTROL PLAN
PHASE 1 STAGE 1-A
TYPICAL SECTION

SHEET 4 OF 4

DESIGN I/E	FED. RD. DIV. NO.	FEDERAL AID PROJECT NO.		HIGHWAY NO.
GRAPHICS I/E	6	SEE TITLE SHEET		FM 1378, ETC.
CHECK J/I	STATE	DISTRICT	COUNTY	SHEET NO.
CHECK	TEXAS	DAL	COLLIN	32
	CONTROL	SECTION	JOB	
	1392	01	044, ETC.	

FILE: c:\txdot\pw\on1\ine\txdot5\ibrahim.e\saad\0326854\TCP_PHASE_1_STAGE_1-A_PLAN_SHEETS.dgn

DATE: 2/16/2023 TIME: 10:50:08 AM

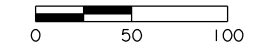
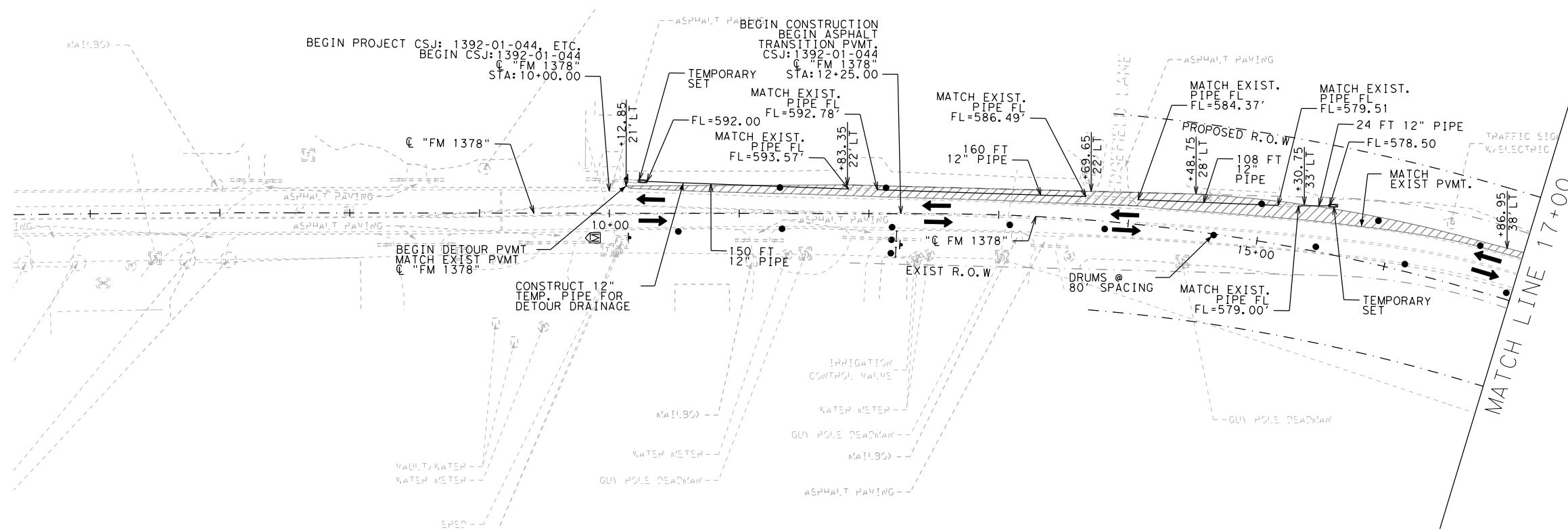

- LEGEND**
- EXISTING PAVEMENT
 - PERMANENT CONSTRUCTION THIS PHASE
 - PERMANENT CONSTRUCTION PREVIOUS PHASE
 - TEMPORARY PAVEMENT CONSTRUCTED THIS PHASE
 - TEMPORARY PAVEMENT CONSTRUCTED PREVIOUS PHASE
 - PORTABLE CONCRETE TRAFFIC BARRIER (PCTB)
 - CRASH CUSHION ATTENUATOR
 - LOW PROFILE CONCRETE BARRIER (LPCB)
 - SIGN POST
 - TYPE III BARRICADE
 - CHANNELIZATION DEVICES
 - DIRECTIONAL TRAFFIC FLOW ARROWS
 - WK ZN PAV MRK REMOV (W) 4" SLD
 - WK ZN PAV MRK REMOV (Y) 4" SLD
 - WK ZN PAV MRK NON-REMOV (W) 4" SLD
 - WK ZN PAV MRK NON-REMOV (Y) 4" SLD
 - WK ZN PAV MRK REMOV (W) 8" SLD
 - WK ZN PAV MRK REMOV (W) 24" SLD
 - MESSAGE BOARD
 - TEMPORARY SHORING

NOTES:
 TRAFFIC UTILIZES EXISTING PAVEMENT MARKINGS EXCEPT WHERE SHOWN
 CONTRACTOR IS RESPONSIBLE FOR MAINTAINING ADEQUATE DRAINAGE DURING CONSTRUCTION.
 CONTRACTOR TO COORDINATE WITH PROPERTY OWNERS TO PROVIDE FIELD ACCESS WHEN REQUESTED.
 REFER TO TCP MISC. DETAILS FOR DRIVEWAY & CROSS STREET CONSTRUCTION
 REFER TO TEMPORARY SIGNAL LAYOUT FOR TEMPORARY TRAFFIC CONFIGURATIONS AT INTERSECTIONS

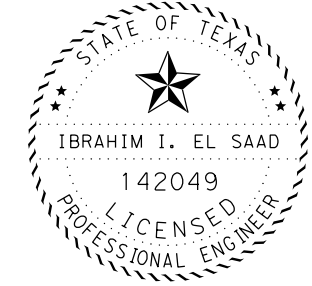

Ibrahim I. El Saad, P.E., 2-16-23
 Signature of Registrant & Date

© 2023

FM 1378
AT FM 3286
TRAFFIC CONTROL PLAN
PHASE 1 STAGE 1-A

SCALE: 1"=100' SHEET 1 OF 5

DESIGN IIE	FED. RD. DIV. NO. 6	FEDERAL AID PROJECT NO. SEE TITLE SHEET		HIGHWAY NO. FM 1378, ETC.
GRAPHICS IIE	STATE TEXAS	DISTRICT DAL	COUNTY COLLIN	SHEET NO. 33
CHECK JI	CONTROL	SECTION	JOB	
CHECK JI	1392	01	044, ETC.	

DATE: 2/16/2023 TIME: 10:50:12 AM FILE: c:\pdx\dot\pw\on\line\t\dot\5\ibrahim.e\isaad\0326854\TCP PHASE 1 STAGE 1-A PLAN SHEETS.dgn

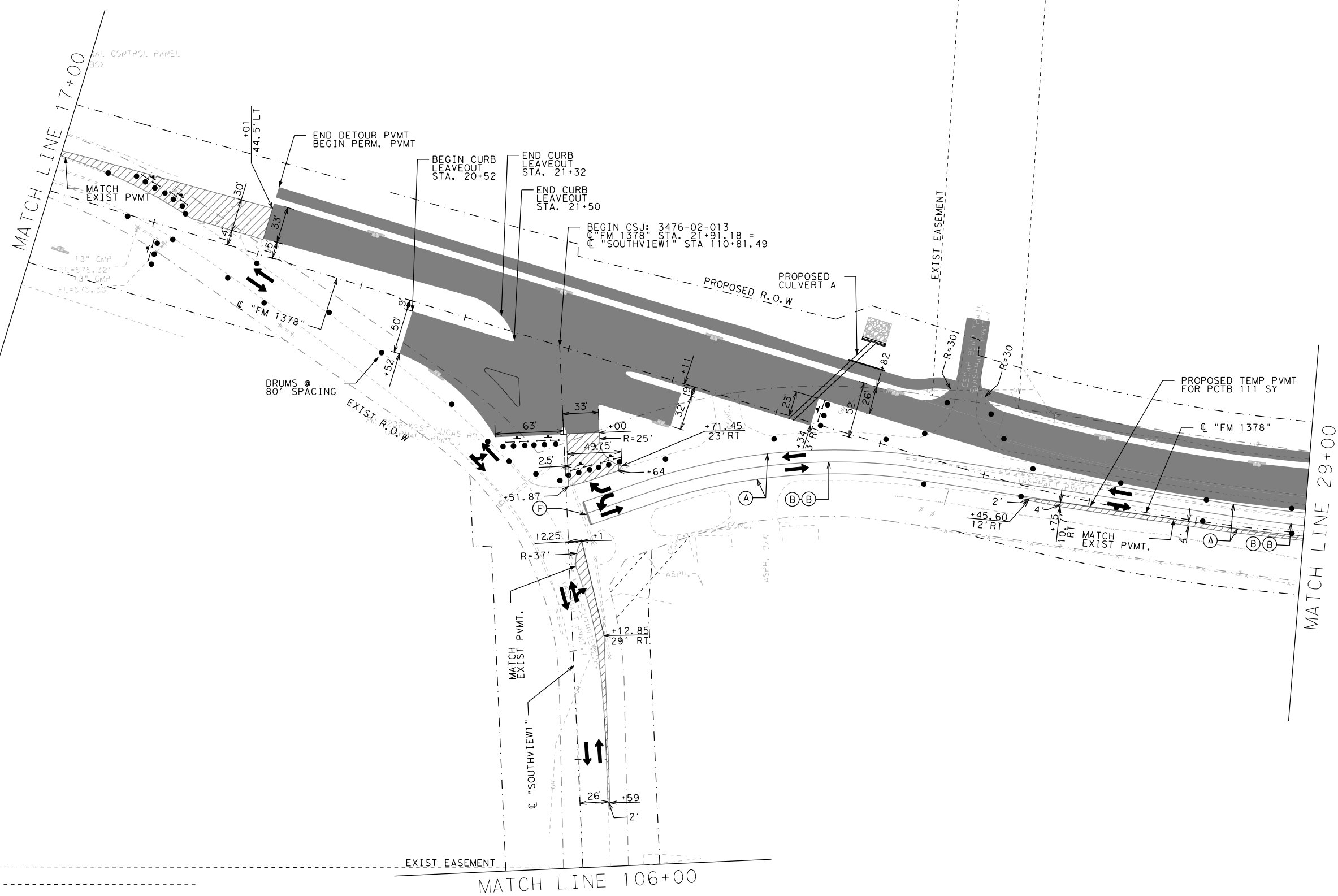

LEGEND

0 50 100

- EXISTING PAVEMENT
- PERMANENT CONSTRUCTION THIS PHASE
- PERMANENT CONSTRUCTION PREVIOUS PHASE
- TEMPORARY PAVEMENT CONSTRUCTED THIS PHASE
- TEMPORARY PAVEMENT CONSTRUCTED PREVIOUS PHASE
- PORTABLE CONCRETE TRAFFIC BARRIER (PCTB)
- CRASH CUSHION ATTENUATOR
- LOW PROFILE CONCRETE BARRIER (LPCB)
- SIGN POST
- TYPE III BARRICADE
- CHANNELIZATION DEVICES
- DIRECTIONAL TRAFFIC FLOW ARROWS
- WK ZN PAV MRK REMOV (W) 4" SLD
- WK ZN PAV MRK REMOV (Y) 4" SLD
- WK ZN PAV MRK NON-REMOV (W) 4" SLD
- WK ZN PAV MRK NON-REMOV (Y) 4" SLD
- WK ZN PAV MRK REMOV (W) 8" SLD
- WK ZN PAV MRK REMOV (W) 24" SLD
- MESSAGE BOARD
- TEMPORARY SHORING

NOTES:
 TRAFFIC UTILIZES EXISTING PAVEMENT MARKINGS EXCEPT WHERE SHOWN.
 CONTRACTOR IS RESPONSIBLE FOR MAINTAINING ADEQUATE DRAINAGE DURING CONSTRUCTION.
 CONTRACTOR TO COORDINATE WITH PROPERTY OWNERS TO PROVIDE FIELD ACCESS WHEN REQUESTED.
 REFER TO TCP MISC. DETAILS FOR DRIVEWAY & CROSS STREET CONSTRUCTION
 REFER TO TEMPORARY SIGNAL LAYOUT FOR TEMPORARY TRAFFIC CONFIGURATIONS AT INTERSECTIONS

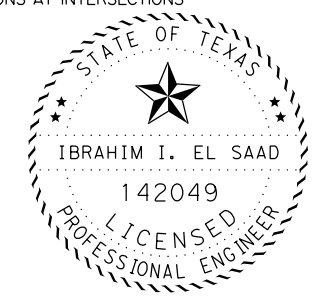

Abraham El Saad, P.E. 2-16-23
 Signature of Registrant & Date

© 2023

Texas Department of Transportation

FM 1378
 AT FM 3286
**TRAFFIC CONTROL PLAN
 PHASE 1 STAGE 1-A**

SCALE: 1"=100' SHEET 2 OF 5

DESIGN IIE	FED. RD. DIV. NO. 6	FEDERAL AID PROJECT NO. SEE TITLE SHEET		HIGHWAY NO. FM 1378, ETC.
GRAPHICS IIE	STATE TEXAS	DISTRICT DAL	COUNTY COLLIN	SHEET NO. 34
CHECK JI	CONTROL	SECTION 1392	JOB 044, ETC.	

DATE: 2/16/2023 TIME: 10:50:16 AM FILE: c:\txdot\pw\onl\ine\txdot5\ibrahim.e\saad\0326854\TCP PHASE 1 STAGE 1-A PLAN SHEETS.dgn

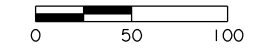
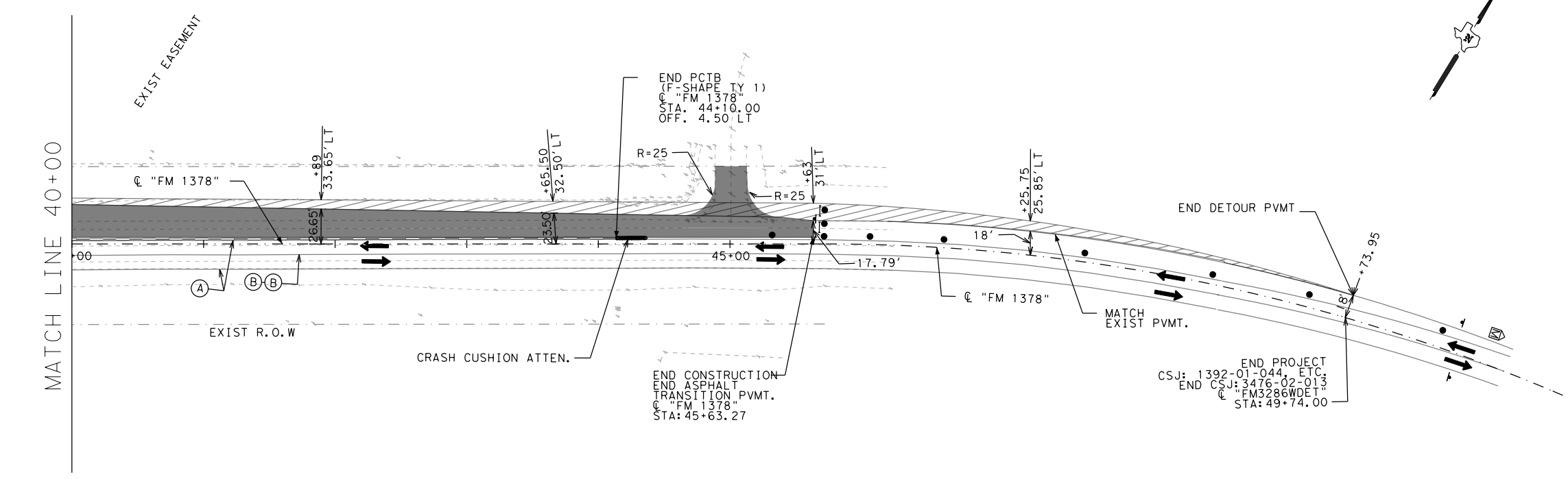
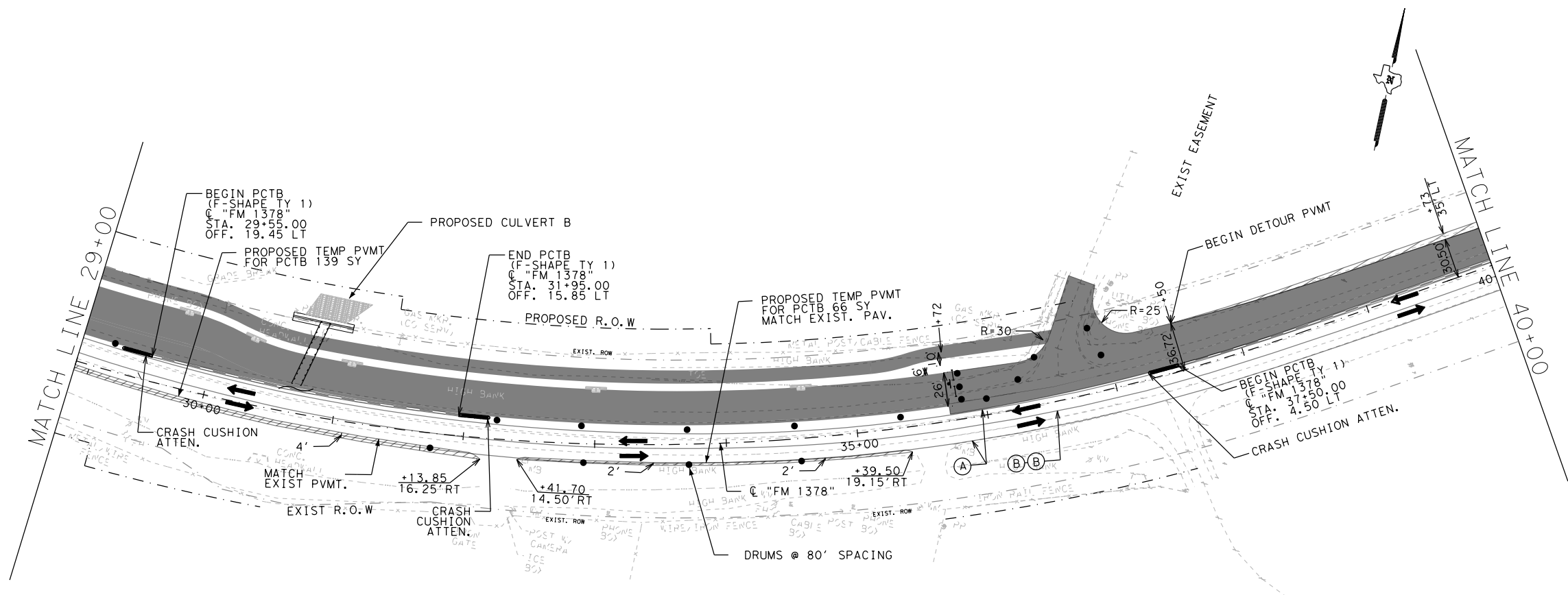

- LEGEND
- EXISTING PAVEMENT
 - PERMANENT CONSTRUCTION THIS PHASE
 - PERMANENT CONSTRUCTION PREVIOUS PHASE
 - TEMPORARY PAVEMENT CONSTRUCTED THIS PHASE
 - TEMPORARY PAVEMENT CONSTRUCTED PREVIOUS PHASE
 - PORTABLE CONCRETE TRAFFIC BARRIER (PCTB)
 - CRASH CUSHION ATTENUATOR
 - LOW PROFILE CONCRETE BARRIER (LPCB)
 - SIGN POST
 - TYPE III BARRICADE
 - CHANNELIZATION DEVICES
 - DIRECTIONAL TRAFFIC FLOW ARROWS
 - WK ZN PAV MRK REMOV (W) 4" SLD
 - WK ZN PAV MRK REMOV (Y) 4" SLD
 - WK ZN PAV MRK NON-REMOV (W) 4" SLD
 - WK ZN PAV MRK NON-REMOV (Y) 4" SLD
 - WK ZN PAV MRK REMOV (W) 8" SLD
 - WK ZN PAV MRK REMOV (W) 24" SLD
 - MESSAGE BOARD
 - TEMPORARY SHORING

NOTES:

TRAFFIC UTILIZES EXISTING PAVEMENT MARKINGS EXCEPT WHERE SHOWN

CONTRACTOR IS RESPONSIBLE FOR MAINTAINING ADEQUATE DRAINAGE DURING CONSTRUCTION.

CONTRACTOR TO COORDINATE WITH PROPERTY OWNERS TO PROVIDE FIELD ACCESS WHEN REQUESTED.

REFER TO TCP MISC. DETAILS FOR DRIVEWAY & CROSS STREET CONSTRUCTION

REFER TO TEMPORARY SIGNAL LAYOUT FOR TEMPORARY TRAFFIC CONFIGURATIONS AT INTERSECTIONS

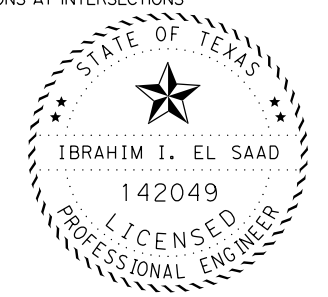

Abraham El Saad, P.E. 2-16-23
Signature of Registrant & Date

© 2023

Texas Department of Transportation

FM 1378
AT FM 3286
TRAFFIC CONTROL PLAN
PHASE 1 STAGE 1-A

SCALE: 1"=100' SHEET 3 OF 5

DESIGN IIE	FED. RD. DIV. NO. 6	FEDERAL AID PROJECT NO. SEE TITLE SHEET		HIGHWAY NO. FM 1378, ETC.
GRAPHICS IIE	STATE TEXAS	DISTRICT DAL	COUNTY COLLIN	SHEET NO. 35
CHECK JI	CONTROL	SECTION	JOB	
CHECK JI	1392	01	044, ETC.	

DATE: 2/28/2023 TIME: 2:01:08 PM FILE: c:\xtdot\pw\on\line\xtdot5\ibrahim.eisaad\0326854\TCP PHASE 1 STAGE 1-A PLAN SHEETS.dgn

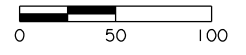
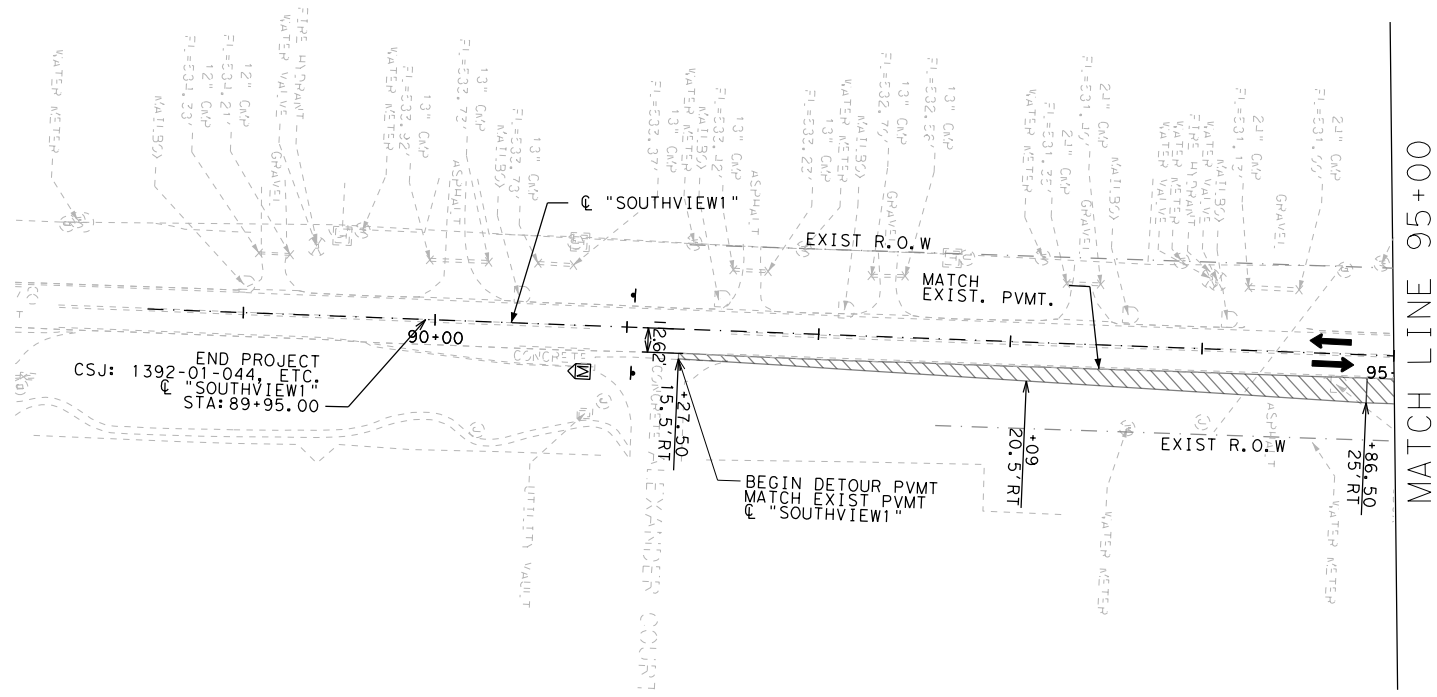
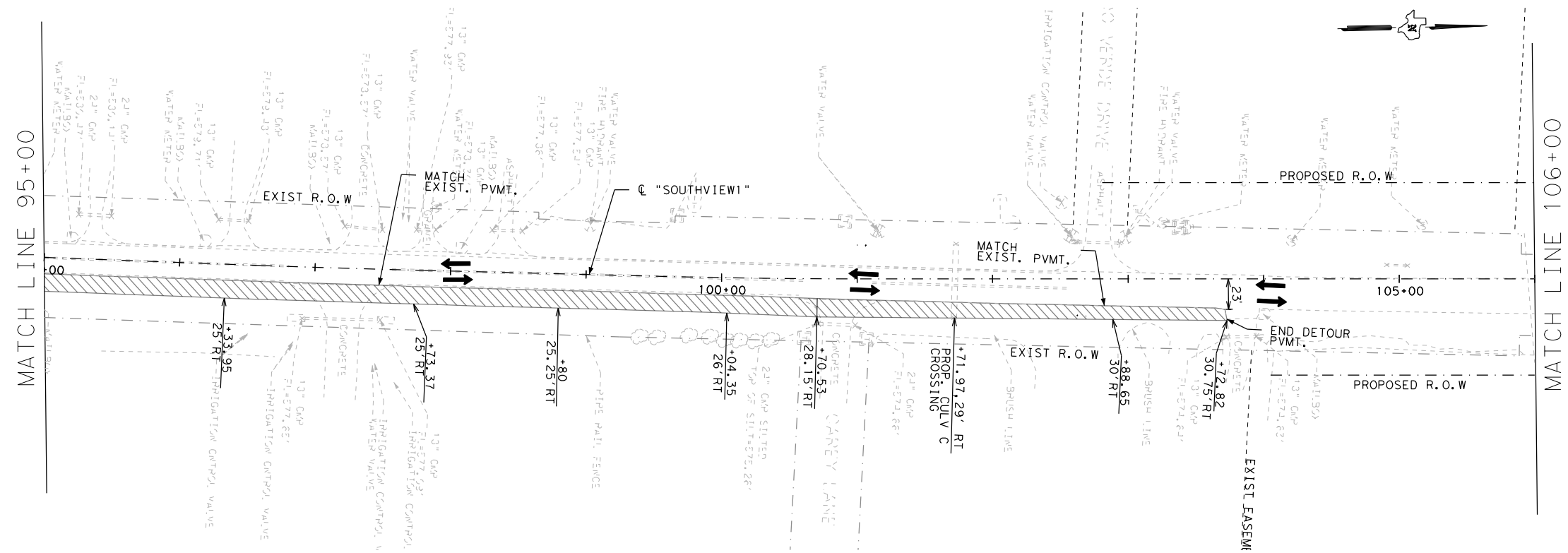

LEGEND

- EXISTING PAVEMENT
- PERMANENT CONSTRUCTION THIS PHASE
- PERMANENT CONSTRUCTION PREVIOUS PHASE
- TEMPORARY PAVEMENT CONSTRUCTED THIS PHASE
- TEMPORARY PAVEMENT CONSTRUCTED PREVIOUS PHASE
- PORTABLE CONCRETE TRAFFIC BARRIER (PCTB)
- CRASH CUSHION ATTENUATOR
- LOW PROFILE CONCRETE BARRIER (LPCB)
- SIGN POST
- TYPE III BARRICADE
- CHANNELIZATION DEVICES
- DIRECTIONAL TRAFFIC FLOW ARROWS
- WK ZN PAV MRK REMOV (W) 4" SLD
- WK ZN PAV MRK REMOV (Y) 4" SLD
- WK ZN PAV MRK NON-REMOV (W) 4" SLD
- WK ZN PAV MRK NON-REMOV (Y) 4" SLD
- WK ZN PAV MRK REMOV (W) 8" SLD
- WK ZN PAV MRK REMOV (W) 24" SLD
- MESSAGE BOARD
- TEMPORARY SHORING

NOTES:
 TRAFFIC UTILIZES EXISTING PAVEMENT MARKINGS EXCEPT WHERE SHOWN

CONTRACTOR IS RESPONSIBLE FOR MAINTAINING ADEQUATE DRAINAGE DURING CONSTRUCTION.

CONTRACTOR TO COORDINATE WITH PROPERTY OWNERS TO PROVIDE FIELD ACCESS WHEN REQUESTED.

REFER TO TCP MISC. DETAILS FOR DRIVEWAY & CROSS STREET CONSTRUCTION

REFER TO TEMPORARY SIGNAL LAYOUT FOR TEMPORARY TRAFFIC CONFIGURATIONS AT INTERSECTIONS

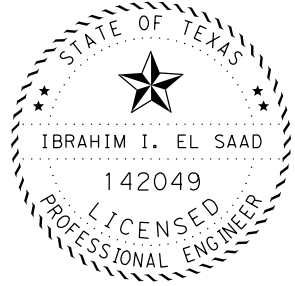

Abraham El Saad, P.E., 2-28-23
 Signature of Registrant & Date



FM 1378
 AT FM 3286
TRAFFIC CONTROL PLAN
PHASE 1 STAGE 1-A

SCALE: 1"=100' SHEET 4 OF 5

DESIGN IIE	FED. RD. DIV. NO. 6	FEDERAL AID PROJECT NO. SEE TITLE SHEET		HIGHWAY NO. FM 1378, ETC.
GRAPHICS IIE	STATE TEXAS	DISTRICT DAL	COUNTY COLLIN	SHEET NO. 36
CHECK JI	CONTROL	SECTION	JOB	
CHECK JI	1392	01	044, ETC.	

FILE: c:\txdot\pw\onlime\txdot5\ibrahim.e\saad\0326854\TCP PHASE 1 STAGE 1-A PLAN SHEETS.dgn DATE: 2/16/2023 TIME: 10:50:22 AM

SUMMARY OF TCP QUANTITIES CSJ: 1392-01-044

ITEM #	DESCRIPTION	UNIT	SHEET TOTAL
508-6001	CONSTRUCTING DETOURS	SY	2900
662-6063	WK ZN PAV MRK REMOV (W) 4" (SLD)	LF	1408
662-6095	WK ZN PAV MRK REMOVE (Y) 4" (SLD)	LF	1409
677-6001	ELIM EXT PAV MRK & MRKS (4")	LF	2816

TCP DETOUR QUANTITIES (1392-01-044)

ITEM #	DESCRIPTION	UNIT	SHEET TOTAL
260-6016	LIME (HYD, COM, OR QK(SLURRY))	TON	49
260-6027	LIME TRT (EXST MATL) (8")	SY	2900
3077-6001	4" SP MIXES SP-B PG64-22	TON	639
3077-6013	2" SP MIXES SP-C SAC-B PG64-22	TON	319
	TEMPORARY DRAINAGE 12" PIPE	LF	442
	TEMPORARY DRAINAGE 12" SET	EA	2

NOTE: FOR CONTRCTOR'S INFORMATION ONLY. DETOURS WILL BE PAID FOR IN ACCORDANCE TO ITEM 508-6001.

SUMMARY OF TCP QUANTITIES CSJ: 3476-02-013

ITEM #	DESCRIPTION	UNIT	SHEET TOTAL
403-6001	TEMPORARY SPL SHORING	SF	595
508-6001	CONSTRUCTING DETOURS	SY	1189
512-6005	PORT CTB (FUR & INST)(F-SHAPE)(TY 1)	LF	900
545-6019	CRASH CUSH ATTEN (INSTL)(S)(N)(TL3)	EA	4
662-6063	WK ZN PAV MRK REMOV (W) 4" (SLD)	LF	5742
662-6075	WK ZN PAV MRK REMOV (W)24"(SLD)	LF	22
662-6095	WK ZN PAV MRK REMOVE (Y) 4" (SLD)	LF	5745
677-6001	ELIM EXT PAV MRK & MRKS (4")	LF	11488
677-6003	ELIM EXT PAV MRK & MRKS (8")	LF	172
677-6007	ELIM EXT PAV MRK & MRKS (24")	LF	24
677-6008	ELIM EXT PAV MRK & MRKS (ARROW)	EA	4
677-6012	ELIM EXT PAV MRK & MRKS (WORD)	EA	4

TCP DETOUR QUANTITIES (3476-02-013)

ITEM #	DESCRIPTION	UNIT	SHEET TOTAL
260-6016	LIME (HYD, COM, OR QK(SLURRY))	TON	20
260-6027	LIME TRT (EXST MATL) (8")	SY	1189
3077-6001	4" SP MIXES SP-B PG64-22	TON	262
3077-6013	2" SP MIXES SP-C SAC-B PG64-22	TON	131

NOTE: FOR CONTRCTOR'S INFORMATION ONLY. DETOURS WILL BE PAID FOR IN ACCORDANCE TO ITEM 508-6001.

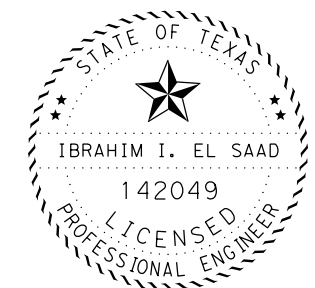

Abraham I. Saad, P.E. 2-16-23
Signature of Registrant & Date

© 2023

**FM 1378
AT FM 3286
SUMMARY OF QUANTITIES
PHASE 1 STAGE 1-A**

SCALE: 1"=100' SHEET 5 OF 5

DESIGN IIE	FED. RD. DIV. NO. 6	FEDERAL AID PROJECT NO. SEE TITLE SHEET		HIGHWAY NO. FM 1378, ETC.
GRAPHICS IIE	STATE TEXAS	DISTRICT DAL	COUNTY COLLIN	SHEET NO.
CHECK JI	CONTROL	SECTION	JOB	37
CHECK JI	1392	01	044, ETC.	

FILE: c:\txdot\pw\onl\ine\txdot5\ibrahim.elsaad\d0326854\TCP Typical Sections Sheets P1S1-B.dgn

DATE: 2/16/2023 TIME: 10:50:30 AM

DATE: 2/16/2023

LEGEND

- PERMANENT CONSTRUCTION THIS PHASE
- PERMANENT CONSTRUCTION PREVIOUS PHASE
- ▨ DETOUR PAVEMENT
- Ⓐ - 2" SUPERPAVE MIXTURES (SP-C) (PG64-22)
- Ⓑ - 4" SUPERPAVE MIXTURES (SP-B) (PG64-22)
- Ⓒ - 8" LTS WITH 5% LIME (EXIST)

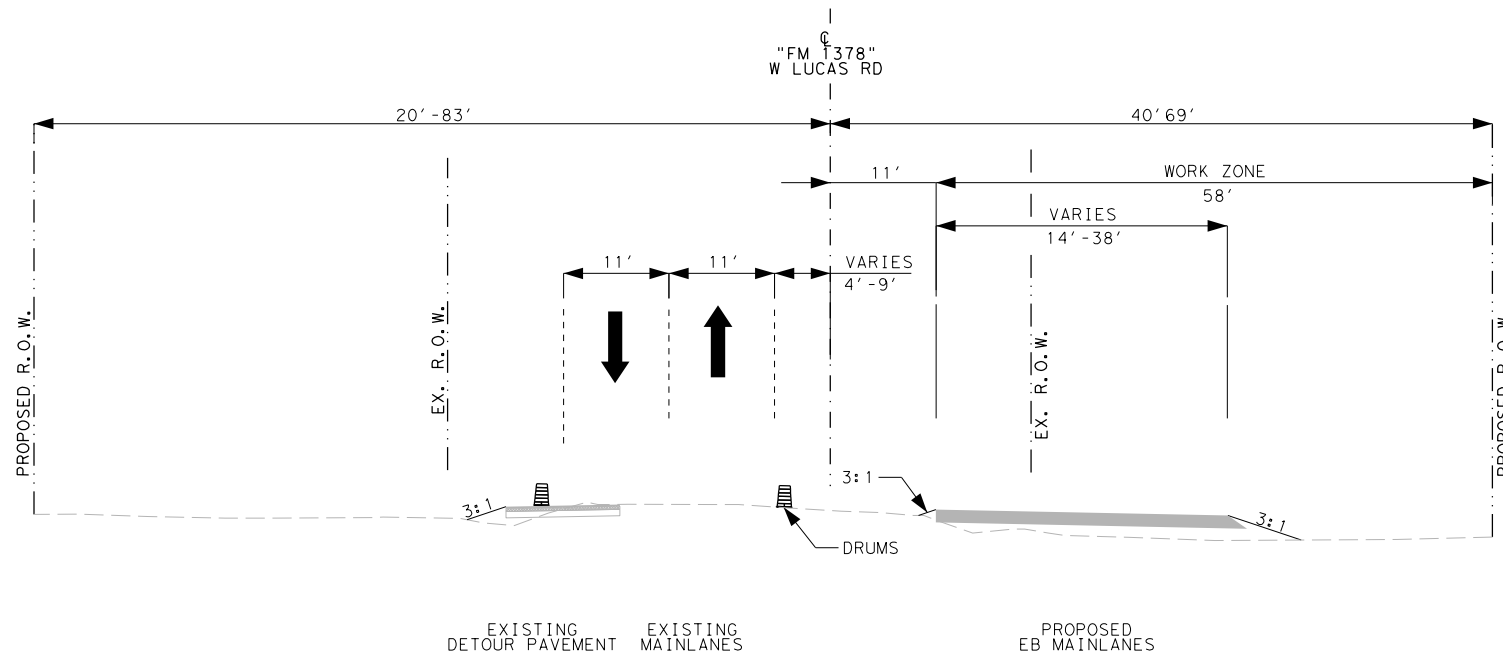

TCP PHASE 1 STAGE 1-B FM 1378 TYPICAL SECTION
 @ "FM 1378" W LUCAS RD STA. 12+25 TO STA. 16+16

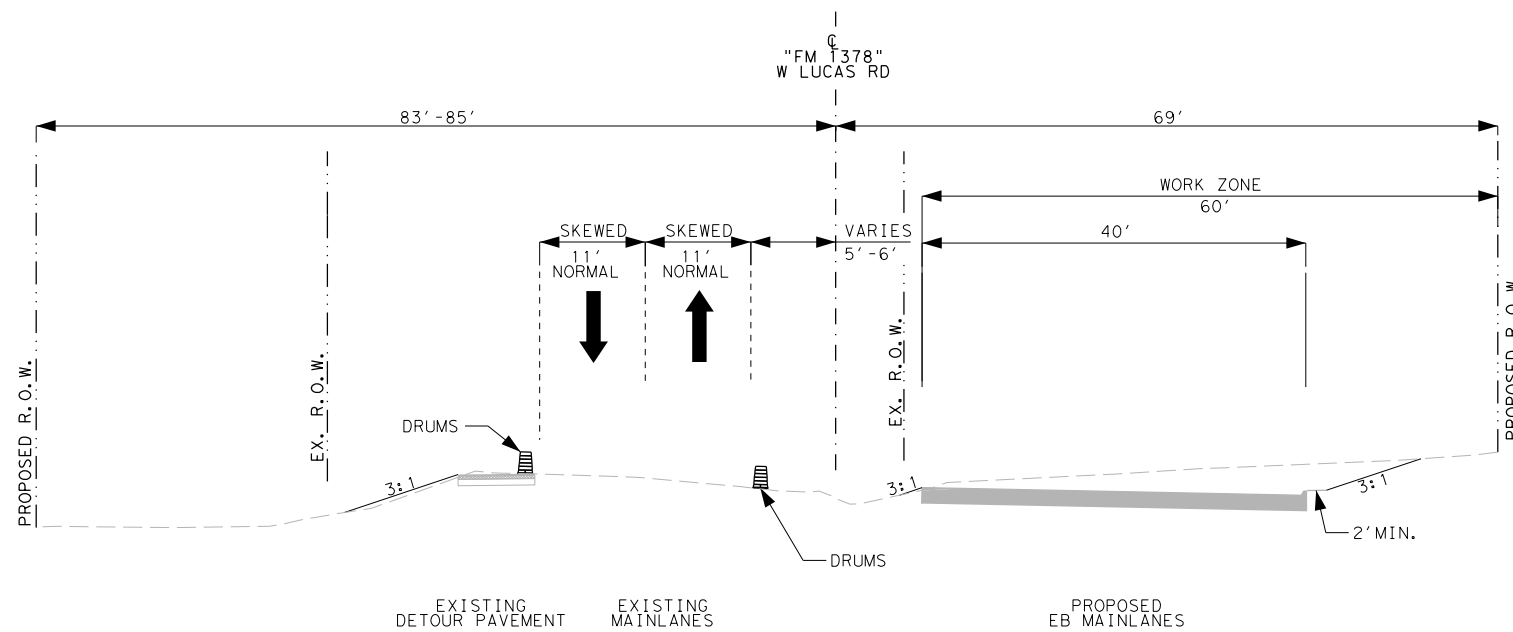

TCP PHASE 1 STAGE 1-B FM 1378 TYPICAL SECTION
 @ "FM 1378" W LUCAS RD STA. 16+16 TO STA. 18+00

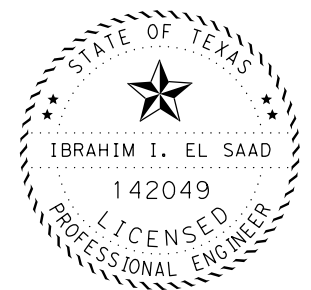

Ibrahim I. El Saad, P.E. 2-16-23
 Signature of Registrant & Date



© 2023

FM 1378
AT FM 3286
TRAFFIC CONTROL PLAN
PHASE 1 STAGE 1-B
TYPICAL SECTION

SCALE: 1"=100' SHEET 1 OF 1

DESIGN IIE	FED. RD. DIV. NO. 6	FEDERAL AID PROJECT NO. SEE TITLE SHEET		HIGHWAY NO. FM 1378, ETC.
GRAPHICS IIE	STATE TEXAS	DISTRICT DAL	COUNTY COLLIN	SHEET NO. 38
CHECK JI	CONTROL 1392	SECTION 01	JOB 044, ETC.	

DATE: 2/16/2023 TIME: 10:50:39 AM FILE: c:\txdot\pw\onl\ine\txdot5\ibrahim.e\saad\0326854\TCP_PHASE_1_STAGE_1-B_PLAN_SHEETS.dgn

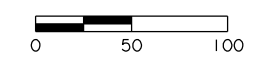
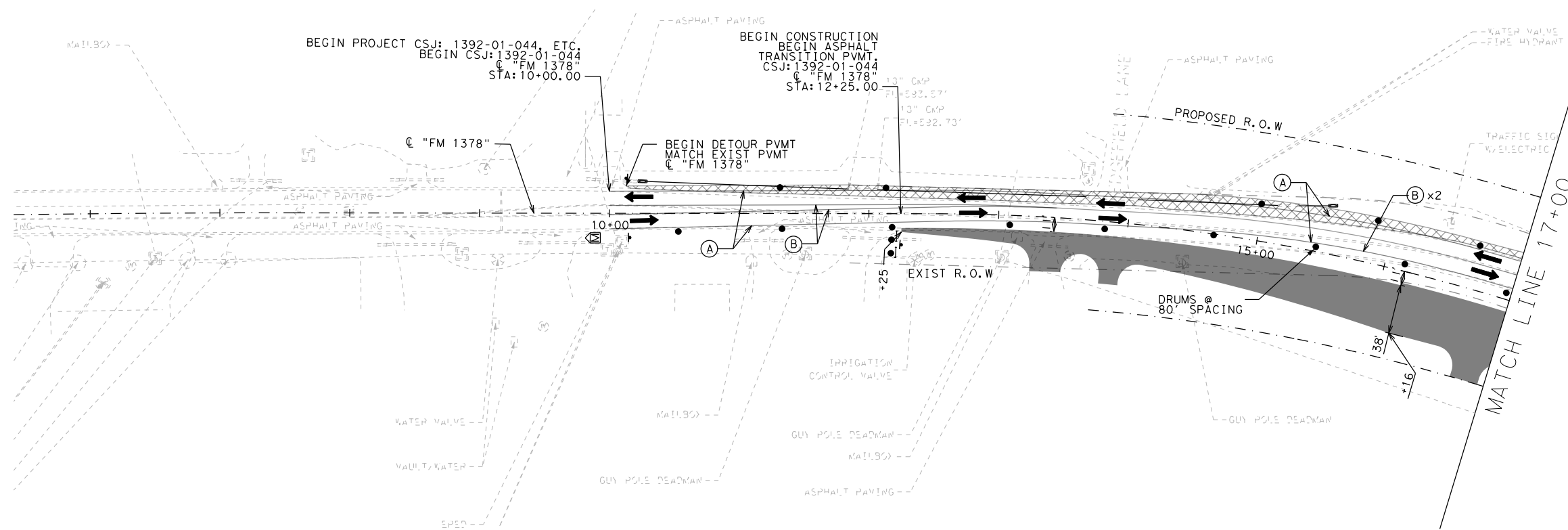

- LEGEND**
- EXISTING PAVEMENT
 - PERMANENT CONSTRUCTION THIS PHASE
 - PERMANENT CONSTRUCTION PREVIOUS PHASE
 - TEMPORARY PAVEMENT CONSTRUCTED THIS PHASE
 - TEMPORARY PAVEMENT CONSTRUCTED PREVIOUS PHASE
 - PORTABLE CONCRETE TRAFFIC BARRIER (PCTB)
 - CRASH CUSHION ATTENUATOR
 - LOW PROFILE CONCRETE BARRIER (LPCB)
 - SIGN POST
 - TYPE III BARRICADE
 - CHANNELIZATION DEVICES
 - DIRECTIONAL TRAFFIC FLOW ARROWS
 - WK ZN PAV MRK REMOV (W) 4" SLD
 - WK ZN PAV MRK REMOV (Y) 4" SLD
 - WK ZN PAV MRK NON-REMOV (W) 4" SLD
 - WK ZN PAV MRK NON-REMOV (Y) 4" SLD
 - WK ZN PAV MRK REMOV (W) 8" SLD
 - WK ZN PAV MRK REMOV (W) 24" SLD
 - MESSAGE BOARD
 - TEMPORARY SHORING

NOTES:
 TRAFFIC UTILIZES EXISTING PAVEMENT MARKINGS EXCEPT WHERE SHOWN

CONTRACTOR IS RESPONSIBLE FOR MAINTAINING ADEQUATE DRAINAGE DURING CONSTRUCTION.

CONTRACTOR TO COORDINATE WITH PROPERTY OWNERS TO PROVIDE FIELD ACCESS WHEN REQUESTED.

REFER TO TCP MISC. DETAILS FOR DRIVEWAY & CROSS STREET CONSTRUCTION

REFER TO TEMPORARY SIGNAL LAYOUT FOR TEMPORARY TRAFFIC CONFIGURATIONS AT INTERSECTIONS

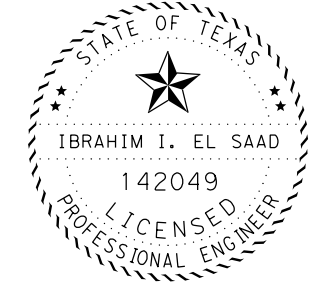

Ibrahim I. El Saad, P.E. 2-16-23
 Signature of Registrant & Date

© 2023

FM 1378
AT FM 3286
TRAFFIC CONTROL PLAN
PHASE 1 STAGE 1-B

SCALE: 1"=100' SHEET 1 OF 3

DESIGN IIE	FED. RD. DIV. NO. 6	FEDERAL AID PROJECT NO. SEE TITLE SHEET		HIGHWAY NO. FM 1378, ETC.
GRAPHICS IIE	STATE TEXAS	DISTRICT DAL	COUNTY COLLIN	SHEET NO. 39
CHECK JI	CONTROL	SECTION	JOB	
CHECK JI	1392	01	044, ETC.	

FILE: c:\xtdot\pw\on\line\txdot\5\ibrahim.e\saad\0326854\TCP_PHASE_1_STAGE_1-B_PLAN_SHEETS.dgn

DATE: 2/16/2023 TIME: 11:17:02 AM

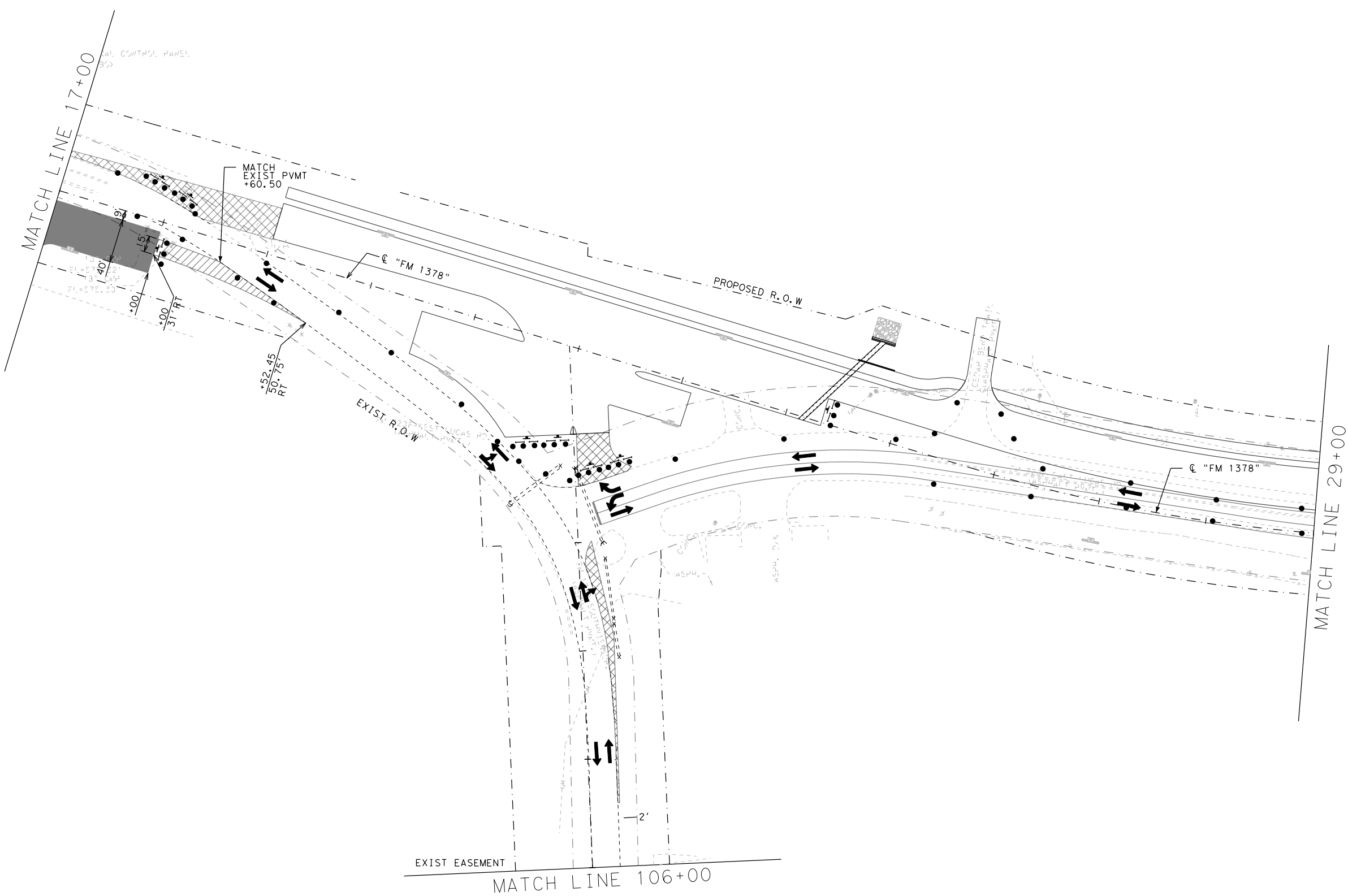

LEGEND

- EXISTING PAVEMENT
- PERMANENT CONSTRUCTION THIS PHASE
- PERMANENT CONSTRUCTION PREVIOUS PHASE
- TEMPORARY PAVEMENT CONSTRUCTED THIS PHASE
- TEMPORARY PAVEMENT CONSTRUCTED PREVIOUS PHASE
- PORTABLE CONCRETE TRAFFIC BARRIER (PCTB)
- CRASH CUSHION ATTENUATOR
- LOW PROFILE CONCRETE BARRIER (LPCB)
- SIGN POST
- TYPE III BARRICADE
- CHANNELIZATION DEVICES
- DIRECTIONAL TRAFFIC FLOW ARROWS
- WK ZN PAV MRK REMOV (W) 4" SLD
- WK ZN PAV MRK REMOV (Y) 4" SLD
- WK ZN PAV MRK NON-REMOV (W) 4" SLD
- WK ZN PAV MRK NON-REMOV (Y) 4" SLD
- WK ZN PAV MRK REMOV (W) 8" SLD
- WK ZN PAV MRK REMOV (W) 24" SLD
- MESSAGE BOARD
- TEMPORARY SHORING

NOTES:

TRAFFIC UTILIZES EXISTING PAVEMENT MARKINGS EXCEPT WHERE SHOWN

CONTRACTOR IS RESPONSIBLE FOR MAINTAINING ADEQUATE DRAINAGE DURING CONSTRUCTION.

CONTRACTOR TO COORDINATE WITH PROPERTY OWNERS TO PROVIDE FIELD ACCESS WHEN REQUESTED.

REFER TO TCP MISC. DETAILS FOR DRIVEWAY & CROSS STREET CONSTRUCTION

REFER TO TEMPORARY SIGNAL LAYOUT FOR TEMPORARY TRAFFIC CONFIGURATIONS AT INTERSECTIONS

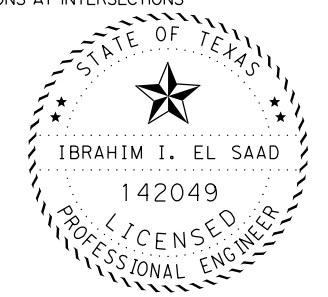

Abraham I. Saad, P.E. 2-16-23
Signature of Registrant & Date

© 2023

FM 1378
AT FM 3286
TRAFFIC CONTROL PLAN
PHASE 1 STAGE 1-B

SCALE: 1"=100' SHEET 2 OF 3

DESIGN IIE	FED. RD. DIV. NO. 6	FEDERAL AID PROJECT NO. SEE TITLE SHEET		HIGHWAY NO. FM 1378, ETC.
GRAPHICS IIE	STATE TEXAS	DISTRICT DAL	COUNTY COLLIN	SHEET NO. 40
CHECK JI	CONTROL	SECTION 01	JOB 044, ETC.	
CHECK JI	1392			

SUMMARY OF TCP QUANTITIES

CSJ: 1392-01-044

ITEM #	DESCRIPTION	UNIT	SHEET TOTAL
508-6001	CONSTRUCTING DETOURS	SY	171

TCP DETOUR QUANTITIES (1392-01-044)

ITEM #	DESCRIPTION	UNIT	SHEET TOTAL
260-6016	LIME (HYD, COM, OR QK(SLURRY))	TON	3
260-6027	LIME TRT (EXST MATL) (8")	SY	171
3077-6001	4" SP MIXES SP-B PG64-22	TON	38
3077-6013	2" SP MIXES SP-C SAC-B PG64-22	TON	19

NOTE: FOR CONTRACTOR'S INFORMATION ONLY. DETOURS WILL BE PAID FOR IN ACCORDANCE TO ITEM 508-6001.

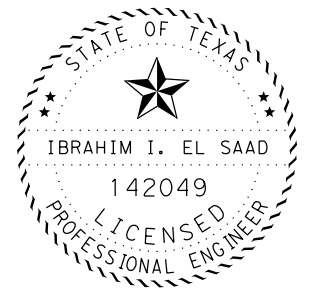

Ibrahim I. Saad, P.E. 2-16-23
Signature of Registrant & Date



© 2023

FM 1378
AT FM 3286
SUMMARY OF QUANTITIES
PHASE 1 STAGE 1-B

SCALE: 1"=100' SHEET 3 OF 3

DESIGN	FED. RD. DIV. NO.	FEDERAL AID PROJECT NO.		HIGHWAY NO.
IIE	6	SEE TITLE SHEET		FM 1378, ETC.
GRAPHICS		STATE	DISTRICT	COUNTY
IIE		TEXAS	DAL	COLLIN
CHECK	CONTROL	SECTION	JOB	
JI	1392	01	044, ETC.	

41

DATE: 2/16/2023 TIME: 10:50:52 AM FILE: c:\txdot\pw\onl\ine\txdot5\ibrahim.elsaad\0326854\TCP Typical Sections Sheets P1S1-C.dgn

- LEGEND**
- PERMANENT CONSTRUCTION THIS PHASE
 - PERMANENT CONSTRUCTION PREVIOUS PHASE
 - ▬ DETOUR PAVEMENT
 - Ⓐ - 2" SUPERPAVE MIXTURES (SP-C) (PG64-22)
 - Ⓑ - 4" SUPERPAVE MIXTURES (SP-B) (PG64-22)
 - Ⓒ - 8" LTS WITH 5% LIME (EXIST)

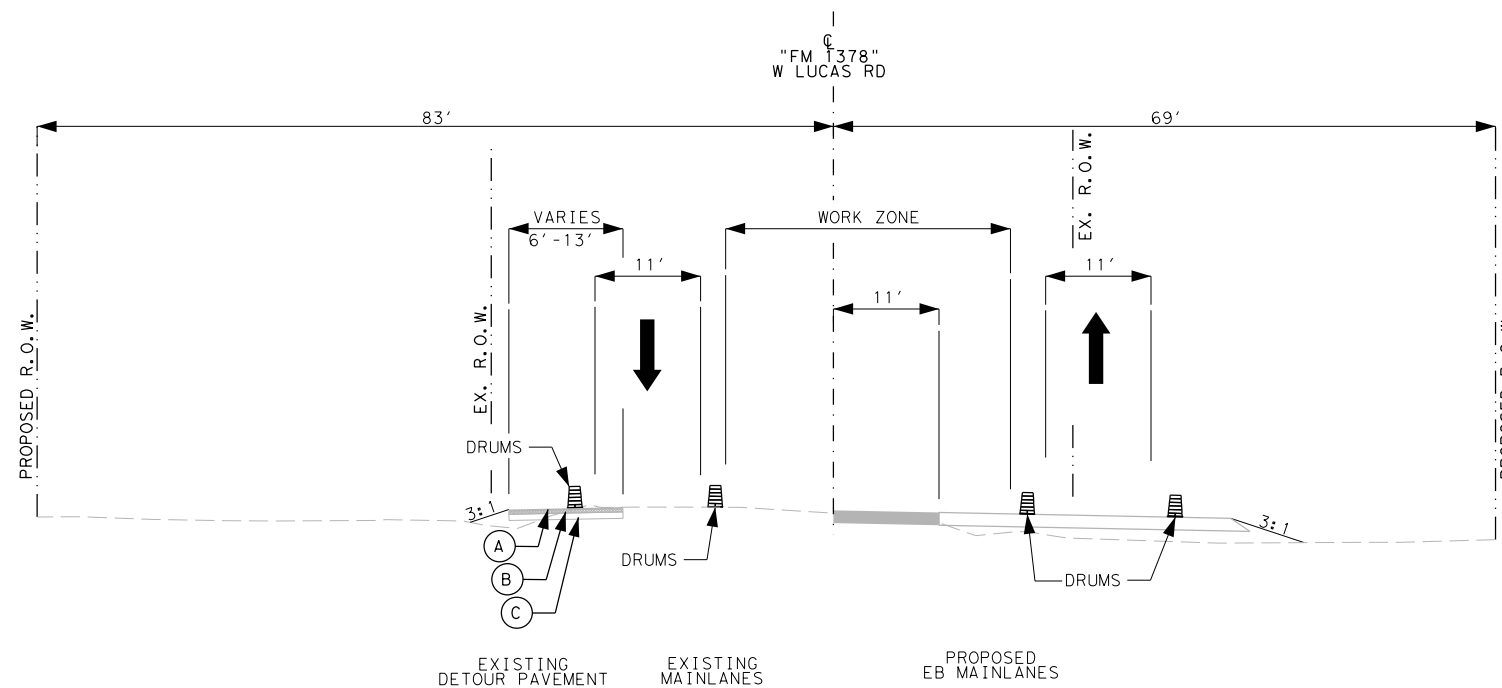

TCP PHASE 1 STAGE 1-C FM 1378 TYPICAL SECTION
 @ "FM 1378" W LUCAS RD STA. 13+45 TO STA. 16+16

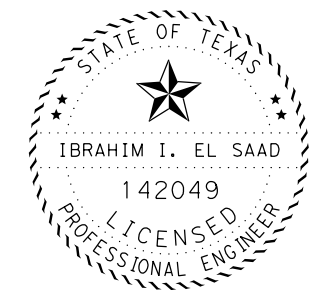

Ibrahim I. Saad, P.E. 2-16-23
 Signature of Registrant & Date

© 2023

Texas Department of Transportation

FM 1378
AT FM 3286
TRAFFIC CONTROL PLAN
PHASE 1 STAGE 1-C
TYPICAL SECTION

SCALE: 1"=100' SHEET 1 OF 1

DESIGN IIE	FED. RD. DIV. NO. 6	FEDERAL AID PROJECT NO. SEE TITLE SHEET		HIGHWAY NO. FM 1378, ETC.
CHECK JI	STATE TEXAS	DISTRICT DAL	COUNTY COLLIN	42
CHECK JI	CONTROL	SECTION	JOB	
CHECK JI	1392	01	044, ETC.	

FILE: c:\txdot\pw\onl\ine\txdot5\ibrahim.e\saad\0326854\TCP_PHASE_1_STAGE_1-C_PLAN_SHEETS.dgn

DATE: 2/16/2023 TIME: 10:51:02 AM

DATE: 2/16/2023

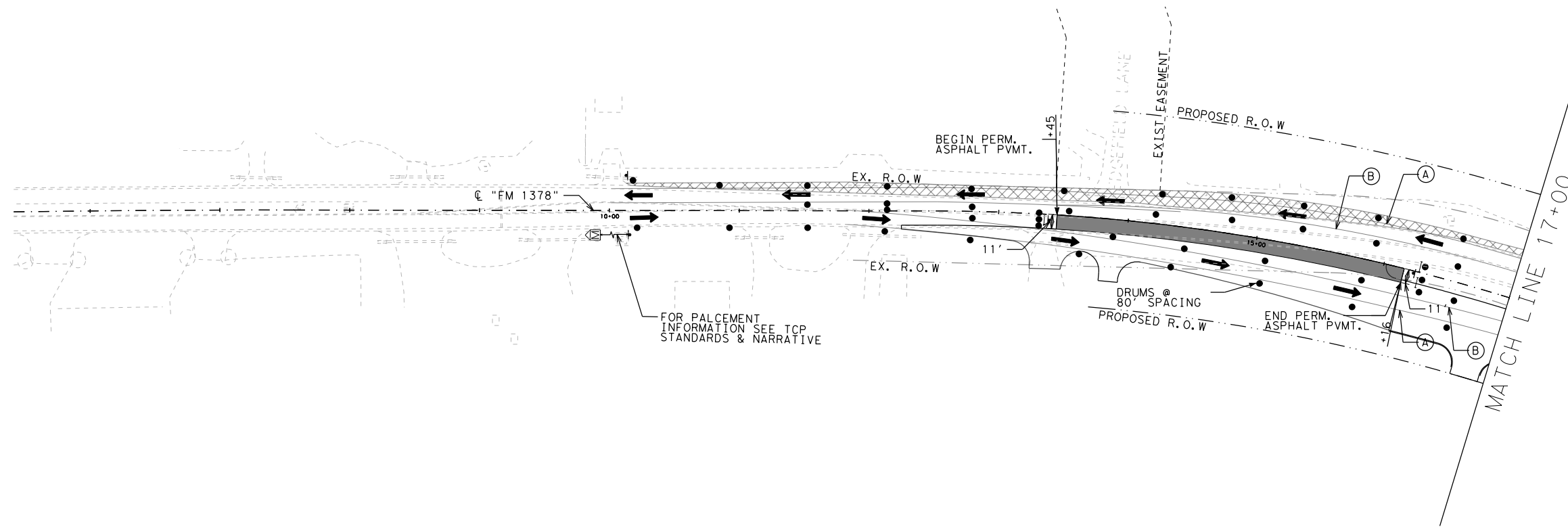

FOR PALCEMENT INFORMATION SEE TCP STANDARDS & NARRATIVE

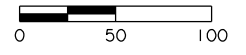

- LEGEND
- EXISTING PAVEMENT
 - PERMANENT CONSTRUCTION THIS PHASE
 - PERMANENT CONSTRUCTION PREVIOUS PHASE
 - TEMPORARY PAVEMENT CONSTRUCTED THIS PHASE
 - TEMPORARY PAVEMENT CONSTRUCTED PREVIOUS PHASE
 - PORTABLE CONCRETE TRAFFIC BARRIER (PCTB)
 - CRASH CUSHION ATTENUATOR
 - LOW PROFILE CONCRETE BARRIER (LPCB)
 - SIGN POST
 - TYPE III BARRICADE
 - CHANNELIZATION DEVICES
 - DIRECTIONAL TRAFFIC FLOW ARROWS
 - WK ZN PAV MRK REMOV (W) 4" SLD
 - WK ZN PAV MRK REMOV (Y) 4" SLD
 - WK ZN PAV MRK NON-REMOV (W) 4" SLD
 - WK ZN PAV MRK NON-REMOV (Y) 4" SLD
 - WK ZN PAV MRK REMOV (W) 8" SLD
 - WK ZN PAV MRK REMOV (W) 24" SLD
 - MESSAGE BOARD
 - TEMPORARY SHORING

NOTES:

TRAFFIC UTILIZES EXISTING PAVEMENT MARKINGS EXCEPT WHERE SHOWN

CONTRACTOR IS RESPONSIBLE FOR MAINTAINING ADEQUATE DRAINAGE DURING CONSTRUCTION.

CONTRACTOR TO COORDINATE WITH PROPERTY OWNERS TO PROVIDE FIELD ACCESS WHEN REQUESTED.

REFER TO TCP MISC. DETAILS FOR DRIVEWAY & CROSS STREET CONSTRUCTION

REFER TO TEMPORARY SIGNAL LAYOUT FOR TEMPORARY TRAFFIC CONFIGURATIONS AT INTERSECTIONS

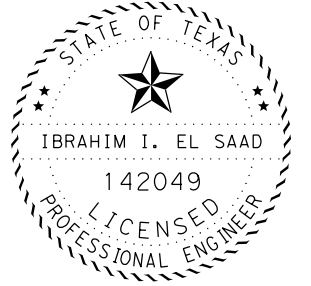

Abraham El Saad, P.E. 2-16-23
Signature of Registrant & Date

© 2023

FM 1378
AT FM 3286
TRAFFIC CONTROL PLAN
PHASE 1 STAGE 1-C

SCALE: 1"=100' SHEET 1 OF 3

DESIGN	FED. RD. DIV. NO.	FEDERAL AID PROJECT NO.		HIGHWAY NO.
IIE	6	SEE TITLE SHEET		FM 1378, ETC.
GRAPHICS		STATE	DISTRICT	COUNTY
IIE		TEXAS	DAL	COLLIN
CHECK		CONTROL	SECTION	JOB
J1		1392	01	044, ETC.

43

DATE: 2/16/2023 TIME: 10:51:05 AM FILE: c:\t\dot\pw\on\line\t\dot\5\ibrahim.e\saad\0326854\TCP PHASE 1 STAGE 1-C PLAN SHEETS.dgn

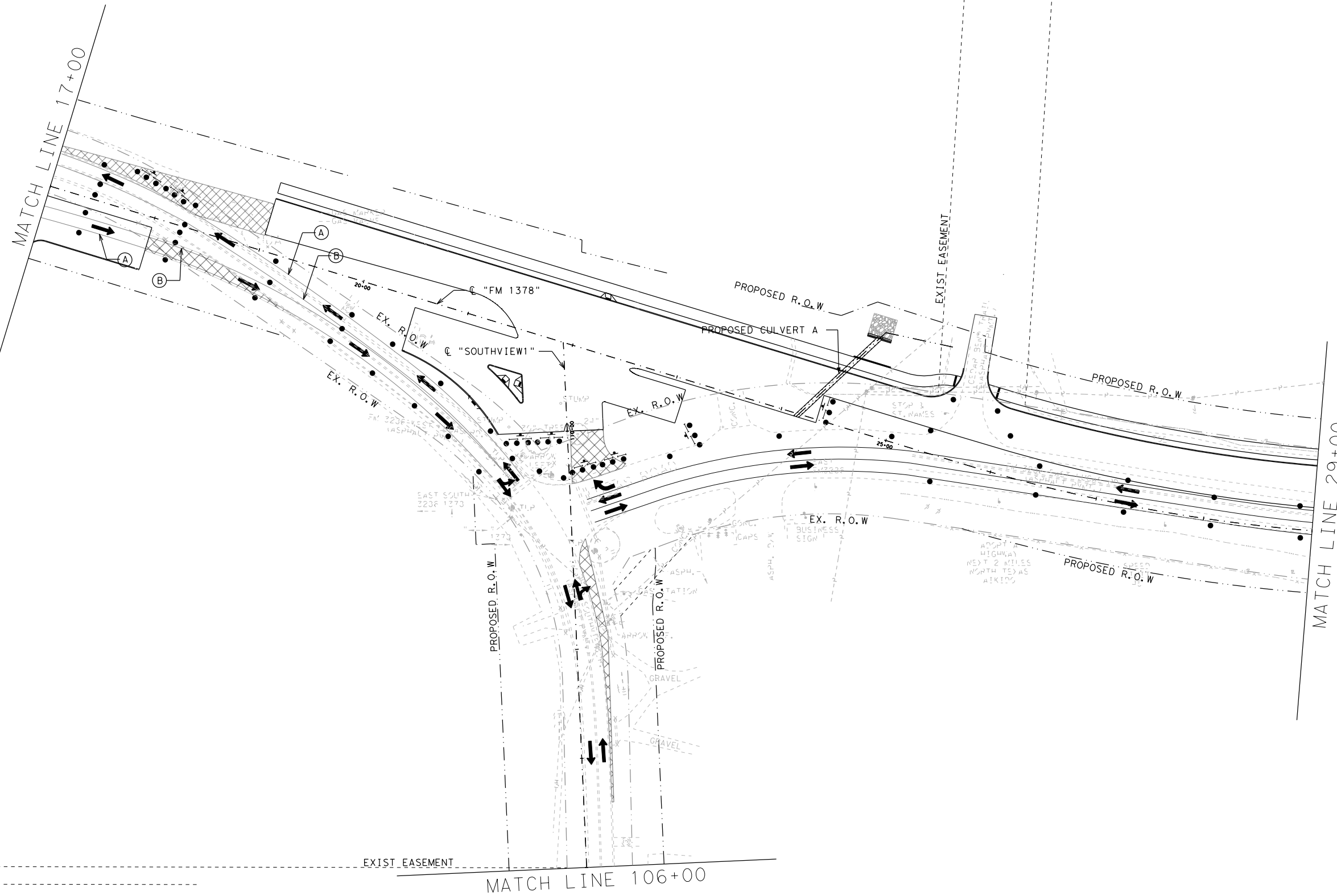

0 50 100

LEGEND

- EXISTING PAVEMENT
- PERMANENT CONSTRUCTION THIS PHASE
- PERMANENT CONSTRUCTION PREVIOUS PHASE
- TEMPORARY PAVEMENT CONSTRUCTED THIS PHASE
- TEMPORARY PAVEMENT CONSTRUCTED PREVIOUS PHASE
- PORTABLE CONCRETE TRAFFIC BARRIER (PCTB)
- CRASH CUSHION ATTENUATOR
- LOW PROFILE CONCRETE BARRIER (LPCB)
- SIGN POST
- TYPE III BARRICADE
- CHANNELIZATION DEVICES
- DIRECTIONAL TRAFFIC FLOW ARROWS
- WK ZN PAV MRK REMOV (W) 4" SLD
- WK ZN PAV MRK REMOV (Y) 4" SLD
- WK ZN PAV MRK NON-REMOV (W) 4" SLD
- WK ZN PAV MRK NON-REMOV (Y) 4" SLD
- WK ZN PAV MRK REMOV (W) 8" SLD
- WK ZN PAV MRK REMOV (W) 24" SLD
- MESSAGE BOARD
- TEMPORARY SHORING

NOTES:
 TRAFFIC UTILIZES EXISTING PAVEMENT MARKINGS EXCEPT WHERE SHOWN

CONTRACTOR IS RESPONSIBLE FOR MAINTAINING ADEQUATE DRAINAGE DURING CONSTRUCTION.

CONTRACTOR TO COORDINATE WITH PROPERTY OWNERS TO PROVIDE FIELD ACCESS WHEN REQUESTED.

REFER TO TCP MISC. DETAILS FOR DRIVEWAY & CROSS STREET CONSTRUCTION

REFER TO TEMPORARY SIGNAL LAYOUT FOR TEMPORARY TRAFFIC CONFIGURATIONS AT INTERSECTIONS

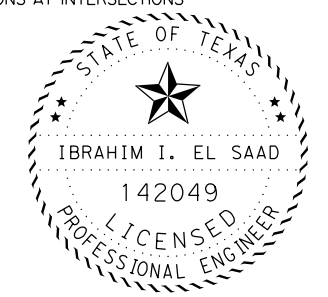

Abraham I. Saad, P.E. 2-16-23
 Signature of Registrant & Date

© 2023

Texas Department of Transportation

FM 1378
AT FM 3286
TRAFFIC CONTROL PLAN
PHASE 1 STAGE 1-C

SCALE: 1"=100' SHEET 2 OF 3

DESIGN	FED. RD. DIV. NO.	FEDERAL AID PROJECT NO.		HIGHWAY NO.
IIE	6	SEE TITLE SHEET		FM 1378, ETC.
GRAPHICS		STATE	DISTRICT	COUNTY
IIE		TEXAS	DAL	COLLIN
CHECK	J1	CONTROL	SECTION	JOB
CHECK	J1	1392	01	044, ETC.

44

DATE: 2/16/2023 TIME: 10:51:06 AM FILE: c:\txdot\pw\onl\ine\txdot5\ibrahim.e\saad\0326854\TCP PHASE 1 STAGE 1-C PLAN SHEETS.dgn

SUMMARY OF TCP QUANTITIES

CSJ: 1392-01-044

ITEM #	DESCRIPTION	UNIT	SHEET TOTAL
662-6063	WK ZN PAV MRK REMOV (W) 4" (SLD)	LF	991
662-6095	WK ZN PAV MRK REMOV (Y) 4" (SLD)	LF	1163
677-6001	ELIM EXT PAV MRK & MRKS (4")	LF	1409

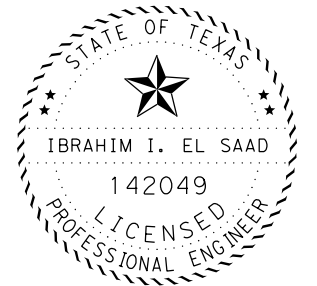

Abraham I. Saad, P.E. 2-16-23
Signature of Registrant & Date



© 2023

FM 1378
AT FM 3286
SUMMARY OF QUANTITIES
PHASE 1 STAGE 1-C

SCALE: 1"=100' SHEET 3 OF 3

DESIGN	FED. RD. DIV. NO.	FEDERAL AID PROJECT NO.		HIGHWAY NO.
IIE	6	SEE TITLE SHEET		FM 1378, ETC.
GRAPHICS				
IIE	STATE	DISTRICT	COUNTY	SHEET NO.
CHECK	TEXAS	DAL	COLLIN	45
JI	CONTROL	SECTION	JOB	
CHECK	JI	1392	01 044, ETC.	

FILE: c:\txdot\pw\onl\ine\txdot5\ibrahim.elsaad\d0326854\TCP Typical Sections Sheets P1S2 .dgn

DATE: 2/16/2023 TIME: 10:51:14 AM

DATE: 2/16/2023

- LEGEND**
- PERMANENT CONSTRUCTION THIS PHASE
 - PERMANENT CONSTRUCTION PREVIOUS PHASE
 - ▬ DETOUR PAVEMENT
 - Ⓐ - 2" SUPERPAVE MIXTURES (SP-C) (PG64-22)
 - Ⓑ - 4" SUPERPAVE MIXTURES (SP-B) (PG64-22)
 - Ⓒ - 8" LTS WITH 5% LIME (EXIST)

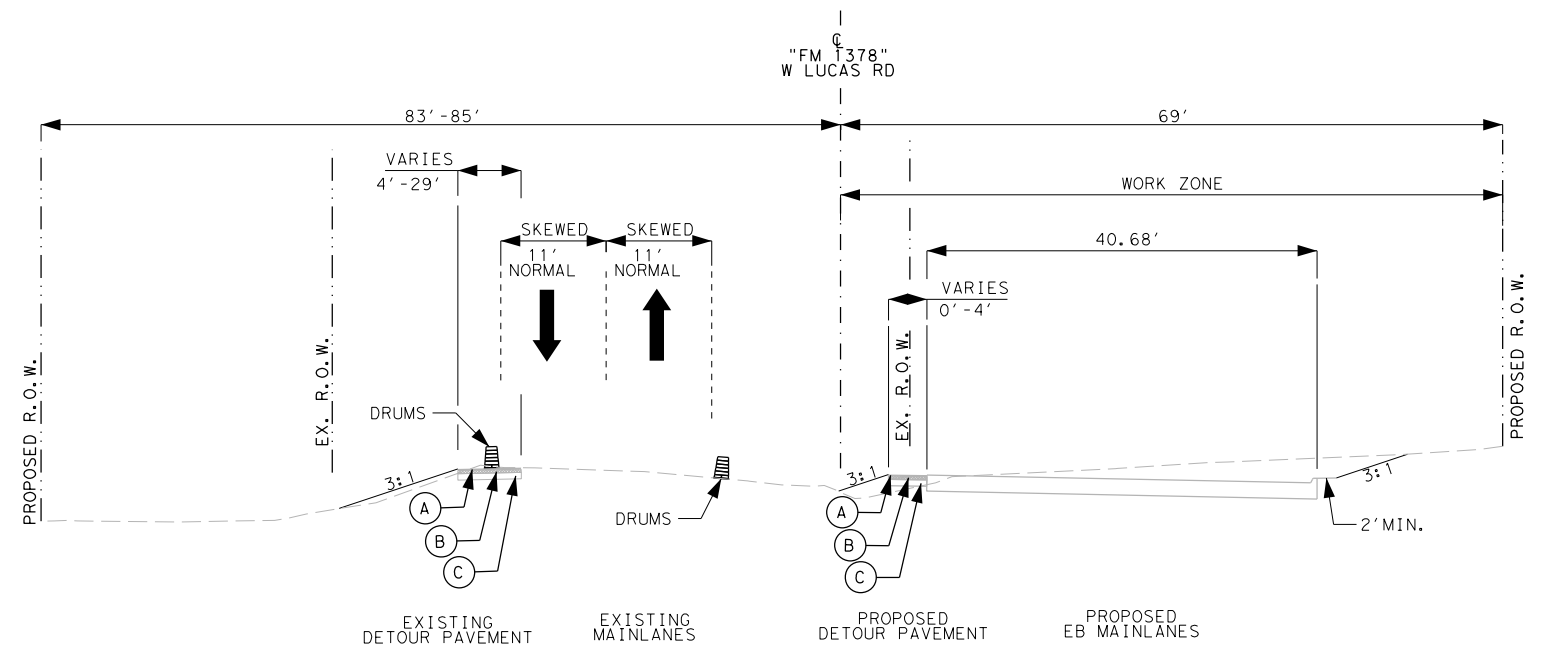

TCP PHASE 1 STAGE 2 FM 1378 TYPICAL SECTION
 @ "FM 1378" W LUCAS RD STA. 16+16 TO STA. 18+00

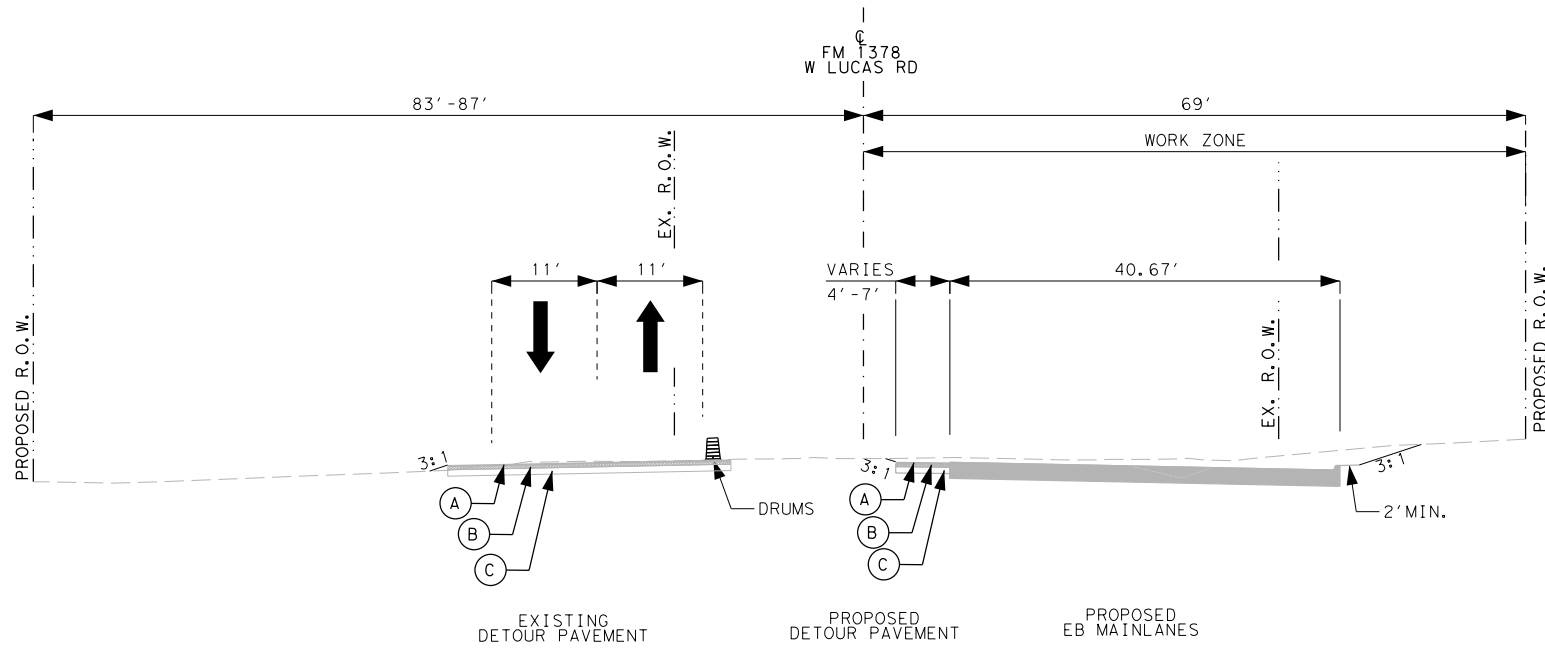

TCP PHASE 1 STAGE 2 FM 1378 TYPICAL SECTION
 @ "FM 1378" W LUCAS RD STA. 18+00 TO STA. 19+01

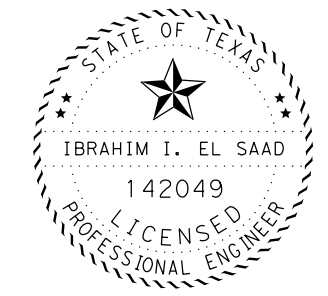

Ibrahim I. El Saad, P.E. 2-16-23
 Signature of Registrant & Date

FM 1378 AT FM 3286 TRAFFIC CONTROL PLAN PHASE 1 STAGE 2 TYPICAL SECTION			
SHEET 1 OF 5			
DESIGN IIE	FED. RD. DIV. NO.	FEDERAL AID PROJECT NO.	
GRAPHICS IIE	6	SEE TITLE SHEET	
CHECK JI	STATE	DISTRICT	COUNTY
CHECK JI	TEXAS	DAL	COLLIN
CHECK JI	CONTROL	SECTION	JOB
CHECK JI	1392	01	044, ETC.
			46

DATE: 2/16/2023 TIME: 10:51:16 AM FILE: c:\txdot\pw\online\txdot5\ibrahim.elsaad\d0326854\TCP Typical Sections Sheets P1S2 .dgn

- LEGEND**
- PERMANENT CONSTRUCTION THIS PHASE
 - PERMANENT CONSTRUCTION PREVIOUS PHASE
 - ▬ DETOUR PAVEMENT
 - Ⓐ - 2" SUPERPAVE MIXTURES (SP-C) (PG64-22)
 - Ⓑ - 4" SUPERPAVE MIXTURES (SP-B) (PG64-22)
 - Ⓒ - 8" LTS WITH 5% LIME (EXIST)

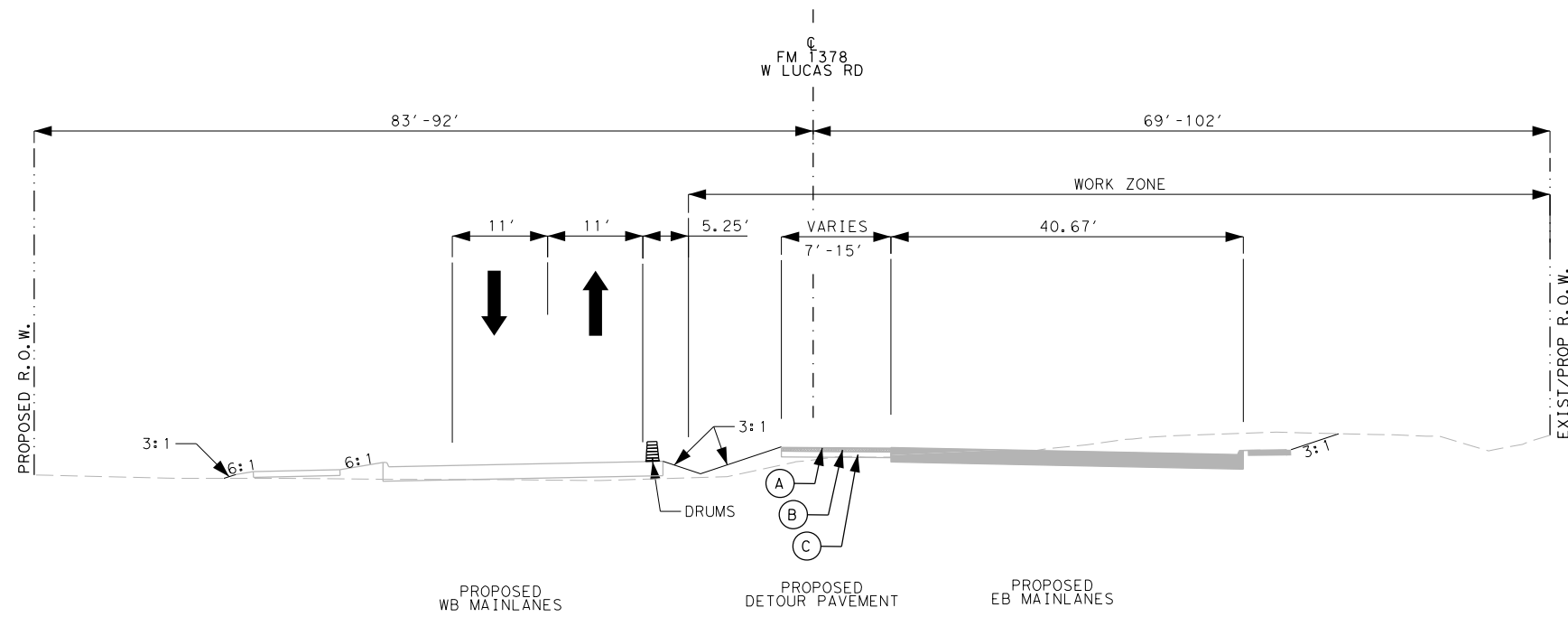

TCP PHASE 1 STAGE 2 FM 1378 TYPICAL SECTION
 @ "FM 1378" W LUCAS RD STA. 19+01 TO STA. 20+52

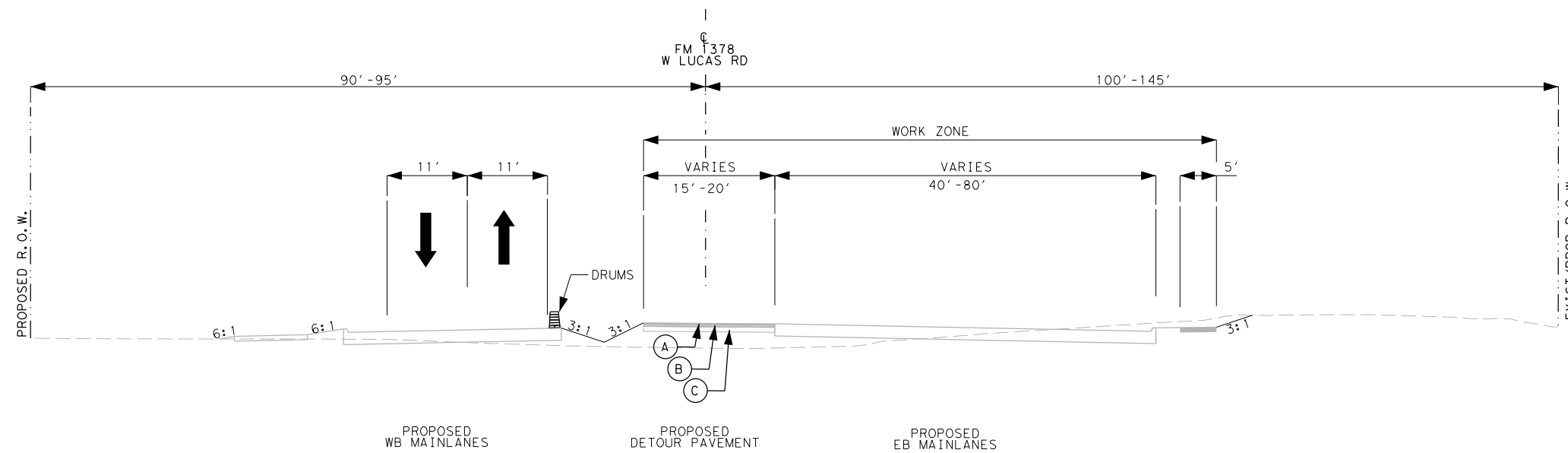

TCP PHASE 1 STAGE 2 FM 1378 TYPICAL SECTION
 @ "FM 1378" W LUCAS RD STA. 20+52 TO STA. 23+11

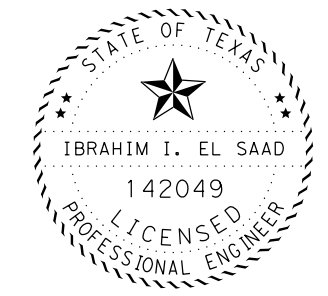

Abraham I. El Saad, P.E. 2-16-23
 Signature of Registrant & Date

FM 1378 AT FM 3286 TRAFFIC CONTROL PLAN PHASE 1 STAGE 2 TYPICAL SECTION			
SHEET 2 OF 5			
DESIGN IIE	FED. RD. DIV. NO. 6	FEDERAL AID PROJECT NO. SEE TITLE SHEET	
GRAPHICS IIE	STATE TEXAS	DISTRICT DAL	HIGHWAY NO. FM 1378, ETC.
CHECK JI	CONTROL	COUNTY COLLIN	47
CHECK JI	SECTION 1392	JOB 044, ETC.	

DATE: 2/16/2023 TIME: 10:51:18 AM FILE: c:\txdot\pw\onl\ine\txdot5\ibrahim.elsaad\0326854\TCP Typical Sections Sheets P1S2 .dgn

- LEGEND**
- PERMANENT CONSTRUCTION THIS PHASE
 - PERMANENT CONSTRUCTION PREVIOUS PHASE
 - ▨ DETOUR PAVEMENT
 - Ⓐ - 2" SUPERPAVE MIXTURES (SP-C) (PG64-22)
 - Ⓑ - 4" SUPERPAVE MIXTURES (SP-B) (PG64-22)
 - Ⓒ - 8" LTS WITH 5% LIME (EXIST)

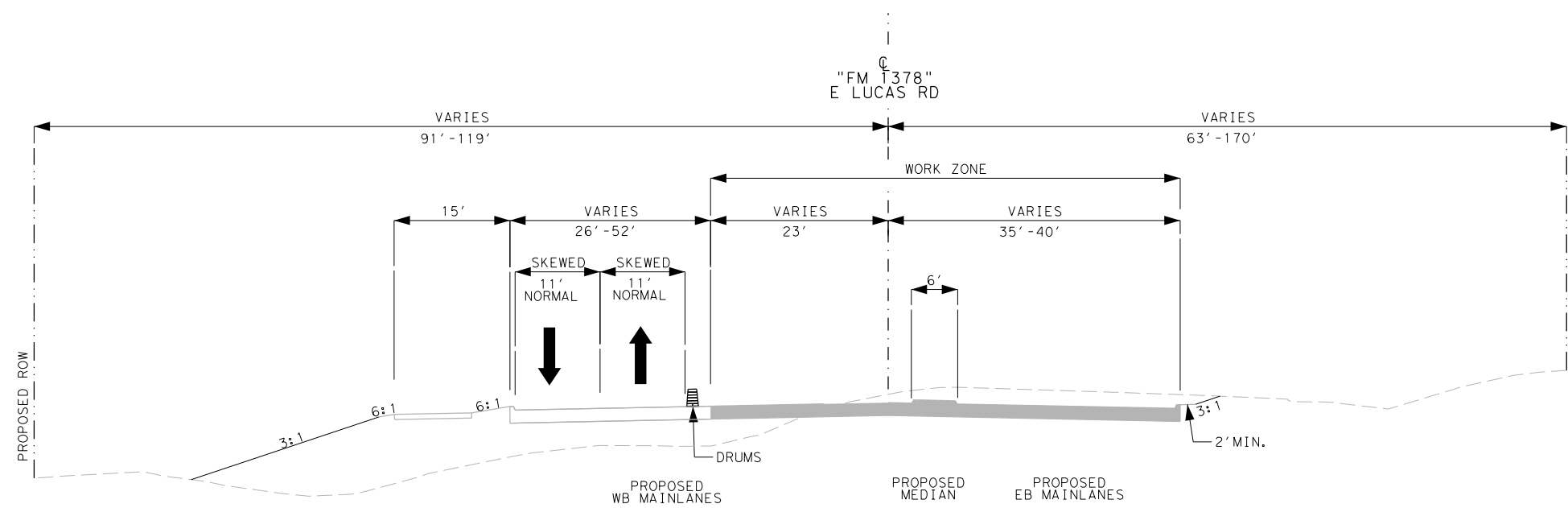

TCP PHASE 1 STAGE 1 FM 3286 TYPICAL SECTION
 CL "FM 1378" E LUCAS RD - STA. 23+11 TO STA. 25+73

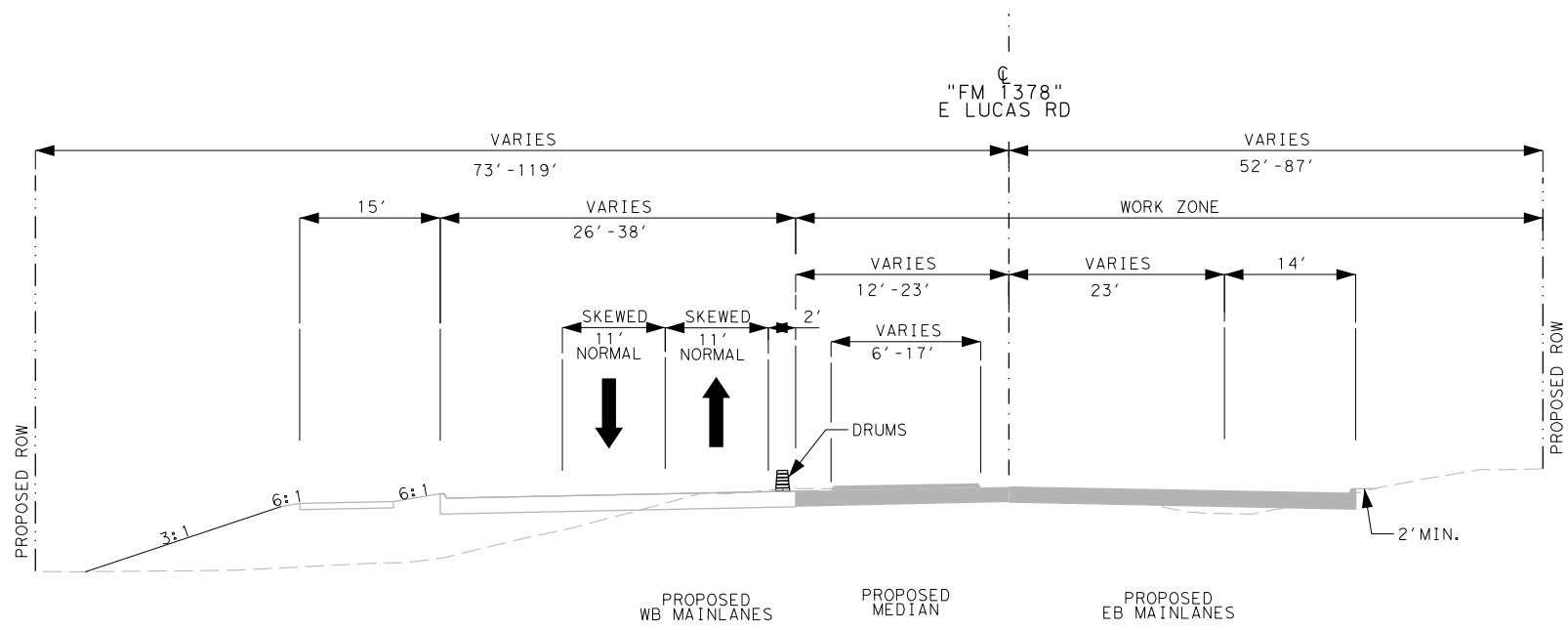

TCP PHASE 1 STAGE 1 FM 3286 TYPICAL SECTION
 CL "FM 1378" E LUCAS RD - STA. 25+73 TO STA. 34+23

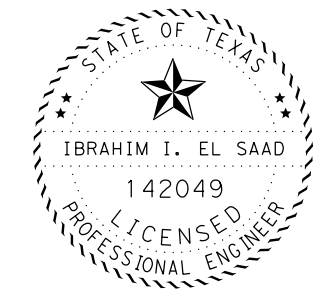

Abraham El Saad, P.E. 2-16-23
 Signature of Registrant & Date

© 2023

Texas Department of Transportation

FM 1378
AT FM 3286
TRAFFIC CONTROL PLAN
PHASE 1 STAGE 2
TYPICAL SECTION

SHEET 3 OF 5

DESIGN IIE	FED. RD. DIV. NO.	FEDERAL AID PROJECT NO.		HIGHWAY NO.
GRAPHICS IIE	6	SEE TITLE SHEET		FM 1378, ETC.
CHECK JI	STATE	DISTRICT	COUNTY	SHEET NO.
CHECK JI	TEXAS	DAL	COLLIN	48
CHECK JI	CONTROL	SECTION	JOB	
CHECK JI	1392	01	044, ETC.	

DATE: 2/16/2023 TIME: 10:51:19 AM FILE: c:\txdot\pw\online\txdot5\ibrahim.eisaad\0326854\TCP Typical Sections Sheets P1S2 .dgn

- LEGEND**
- PERMANENT CONSTRUCTION THIS PHASE
 - PERMANENT CONSTRUCTION PREVIOUS PHASE
 - ▬ DETOUR PAVEMENT
 - Ⓐ - 2" SUPERPAVE MIXTURES (SP-C) (PG64-22)
 - Ⓑ - 4" SUPERPAVE MIXTURES (SP-B) (PG64-22)
 - Ⓒ - 8" LTS WITH 5% LIME (EXIST)

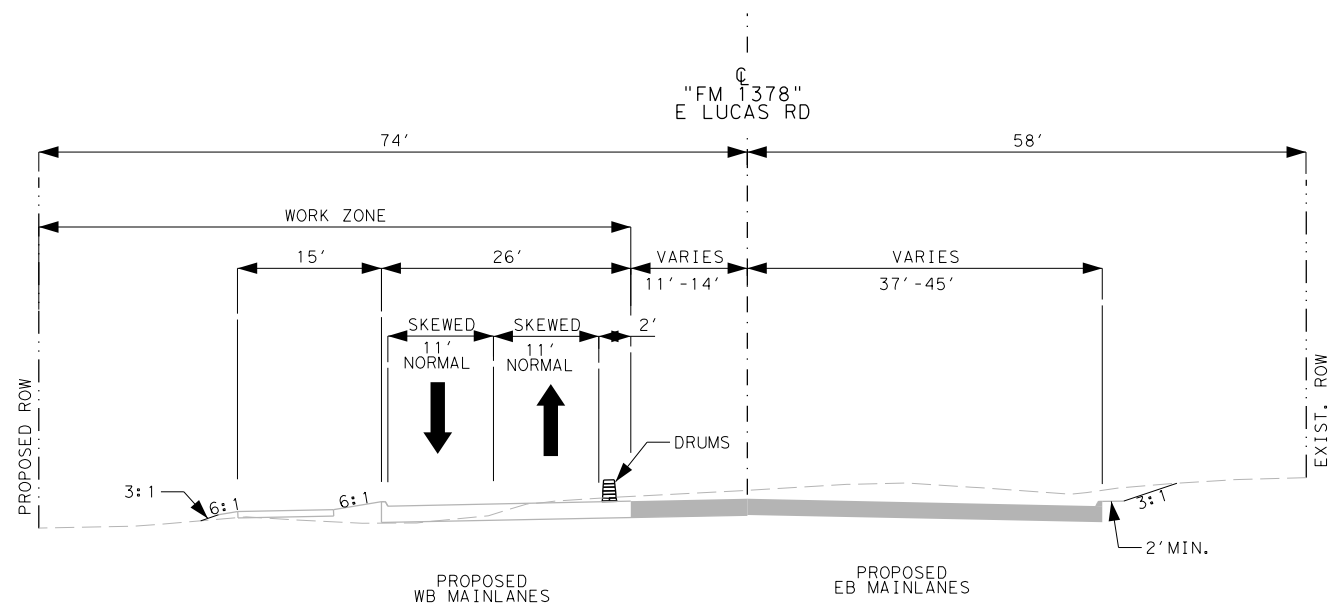

TCP PHASE 1 STAGE 1 FM 3286 TYPICAL SECTION
 @ "FM 1378" E LUCAS RD - STA. 34+23 TO STA. 35+72

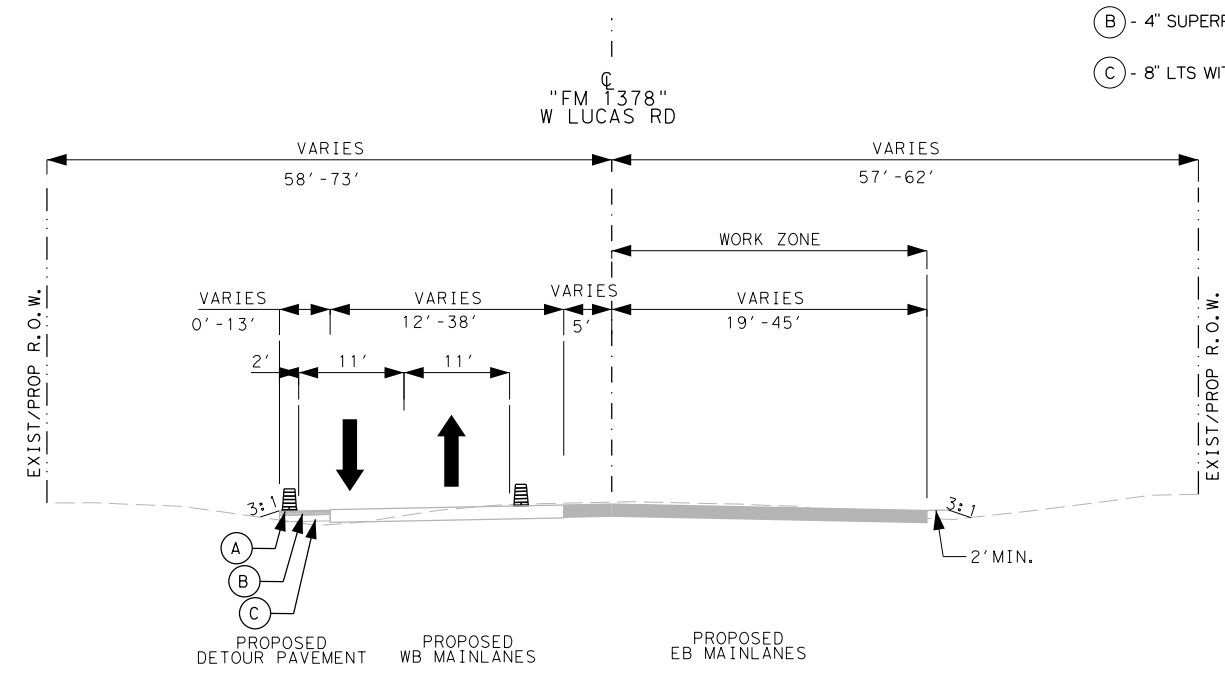

TCP PHASE 1 STAGE 1 FM 3286 TYPICAL SECTION
 @ "FM 1378" E LUCAS RD - STA. 35+72 TO STA. 45+63

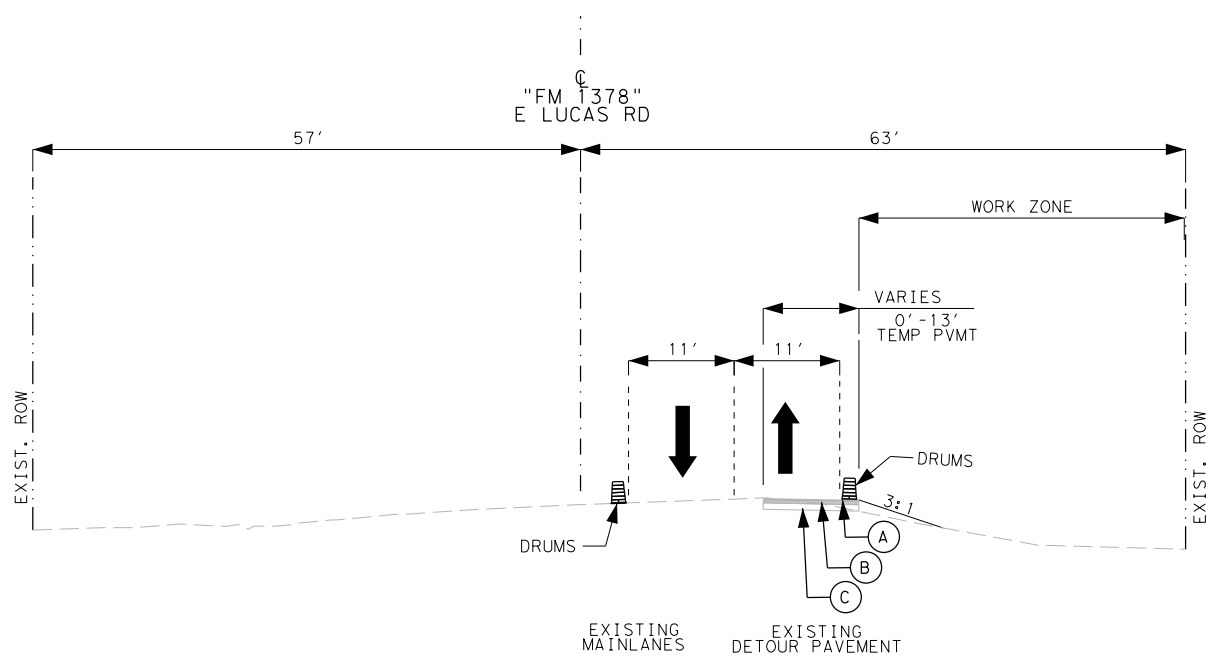

TCP PHASE 1 STAGE 1 FM 3286 TYPICAL SECTION
 @ "FM 1378" E LUCAS RD - STA. 45+63 TO STA. 49+56

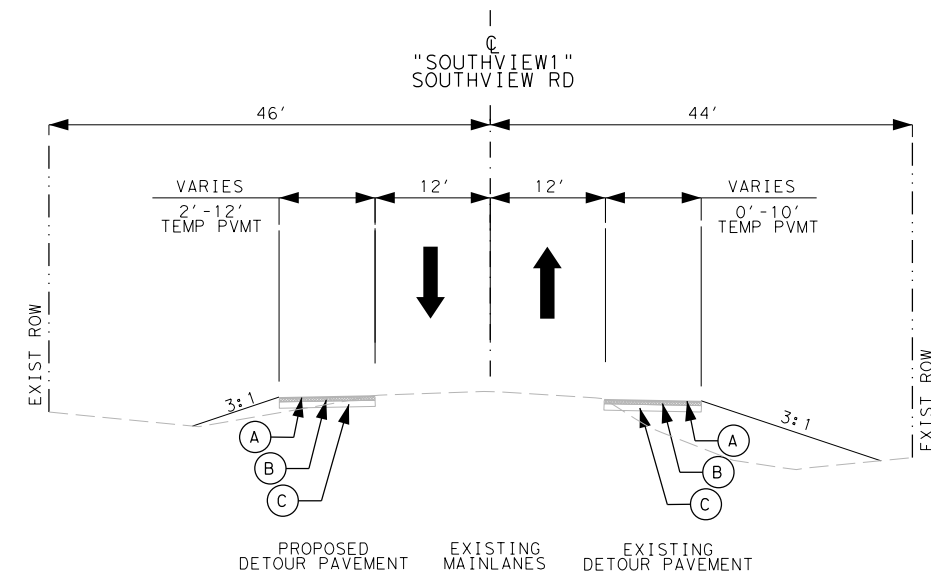

TCP PHASE 1 STAGE 2 FM 1378 TYPICAL SECTION
 @ "SOUTHVIEW1" SOUTHVIEW RD - STA. 90+95 TO STA. 94+86

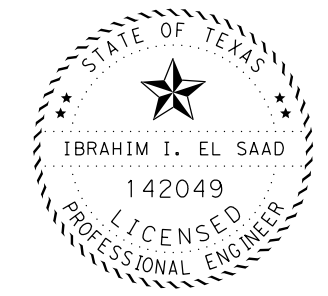

Abraham El Saad, P.E. 2-16-23
 Signature of Registrant & Date

Texas Department of Transportation				© 2023
FM 1378				
AT FM 3286				
TRAFFIC CONTROL PLAN				
PHASE 1 STAGE 2				
TYPICAL SECTION				
SHEET 4 OF 5				
DESIGN IIE	FED. RD. DIV. NO. 6	FEDERAL AID PROJECT NO. SEE TITLE SHEET		
GRAPHICS IIE	STATE TEXAS	DISTRICT DAL	COUNTY COLLIN	
CHECK JI	CONTROL	SECTION	JOB	
CHECK JI	1392	01	044, ETC.	
			49	

FILE: c:\txdot\pw\onl\ine\txdot5\ibrahim.elsaad\d0326854\TCP Typical Sections Sheets P1S2 .dgn
 DATE: 2/16/2023 TIME: 10:51:21 AM

- LEGEND**
- PERMANENT CONSTRUCTION THIS PHASE
 - PERMANENT CONSTRUCTION PREVIOUS PHASE
 - ▨ DETOUR PAVEMENT
 - A - 2" SUPERPAVE MIXTURES (SP-C) (PG64-22)
 - B - 4" SUPERPAVE MIXTURES (SP-B) (PG64-22)
 - C - 8" LTS WITH 5% LIME (EXIST)

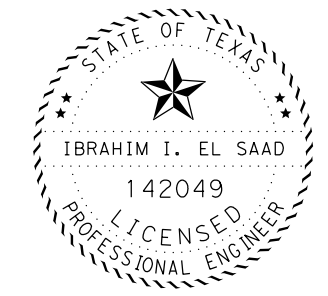
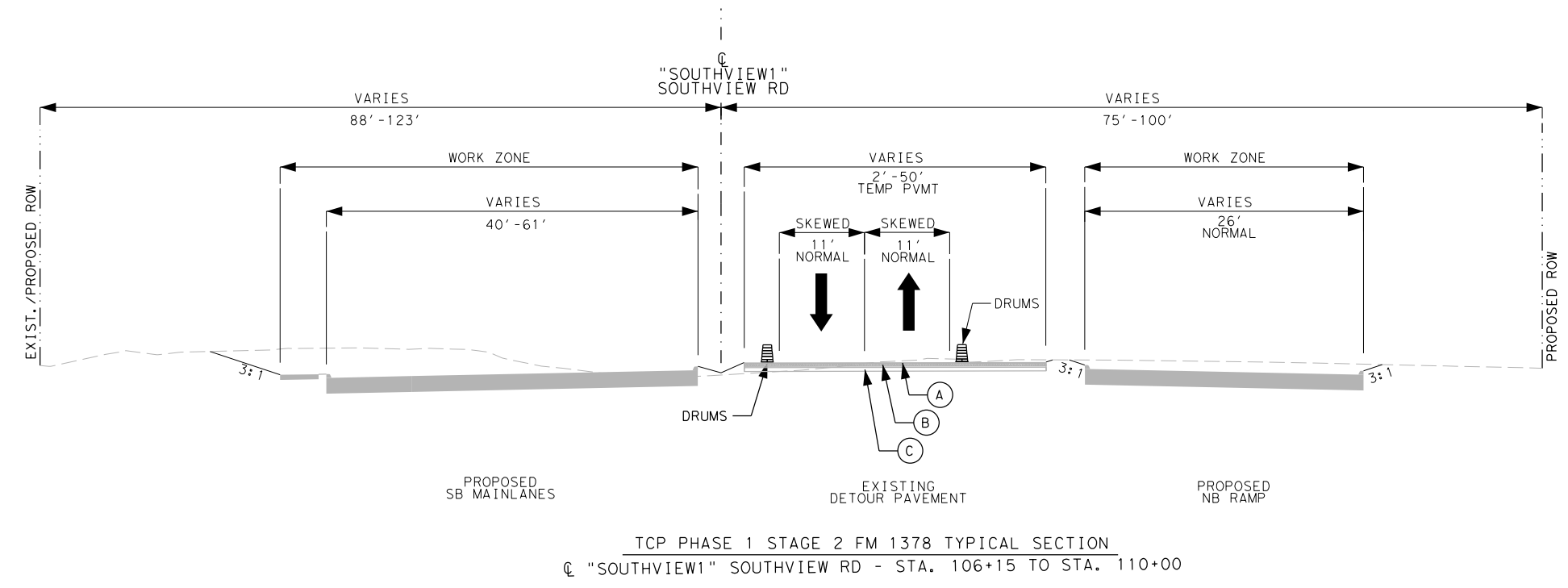
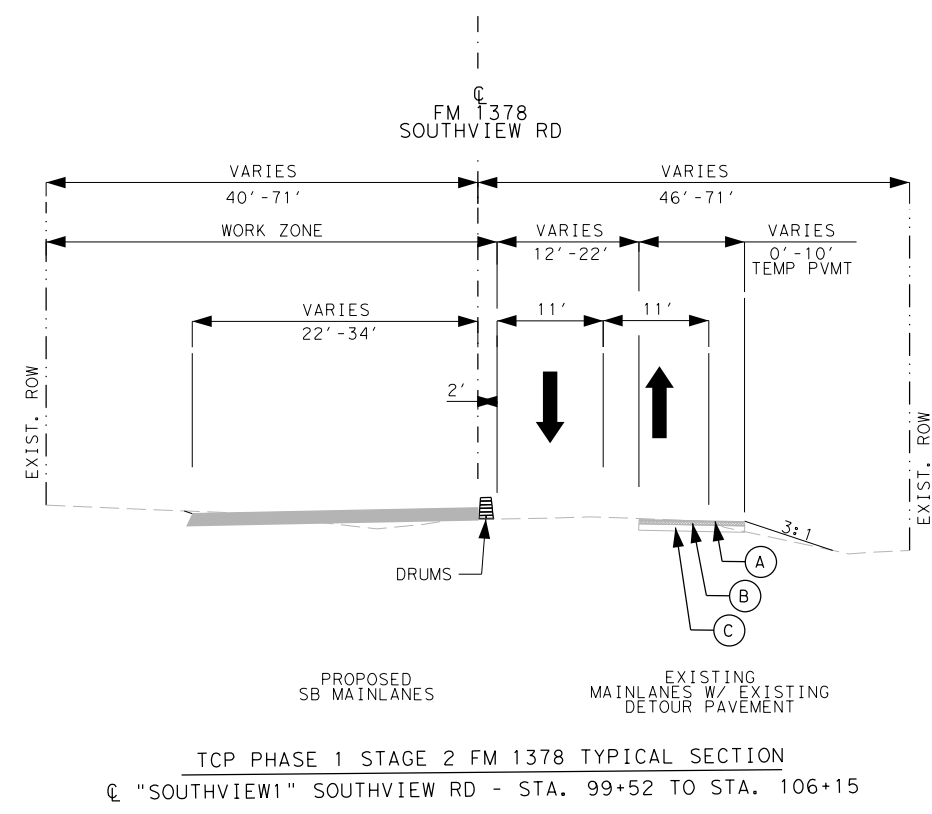
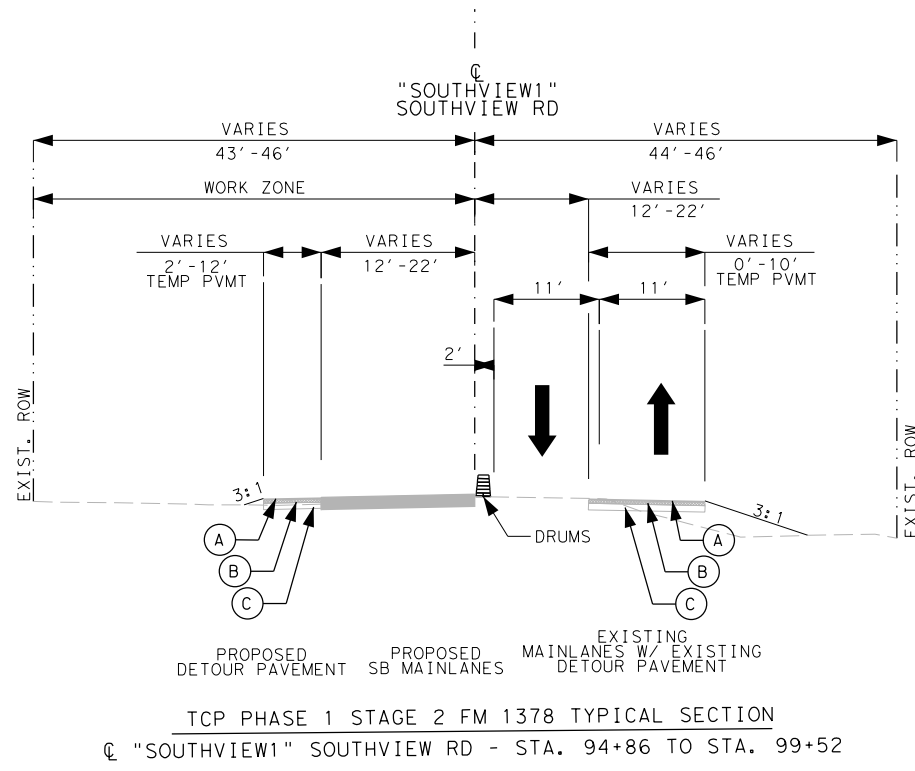

Ibrahim I. El Saad, P.E. 2-16-23
 Signature of Registrant & Date

FM 1378 AT FM 3286 TRAFFIC CONTROL PLAN PHASE 1 STAGE 2 TYPICAL SECTION			
SHEET 5 OF 5			
DESIGN IIE	FED. RD. DIV. NO. 6	FEDERAL AID PROJECT NO. SEE TITLE SHEET	
GRAPHICS IIE	STATE TEXAS	DISTRICT DAL	COUNTY COLLIN
CHECK JI	CONTROL	SECTION	JOB
CHECK JI	1392	01	044, ETC.
			50

DATE: 2/16/2023 TIME: 10:51:31 AM FILE: c:\txdot\pw\onl\ine\txdot\5\ibrahim.e\saad\0326854\TCP PHASE 1 STAGE 2 PLAN SHEETS.dgn

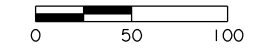
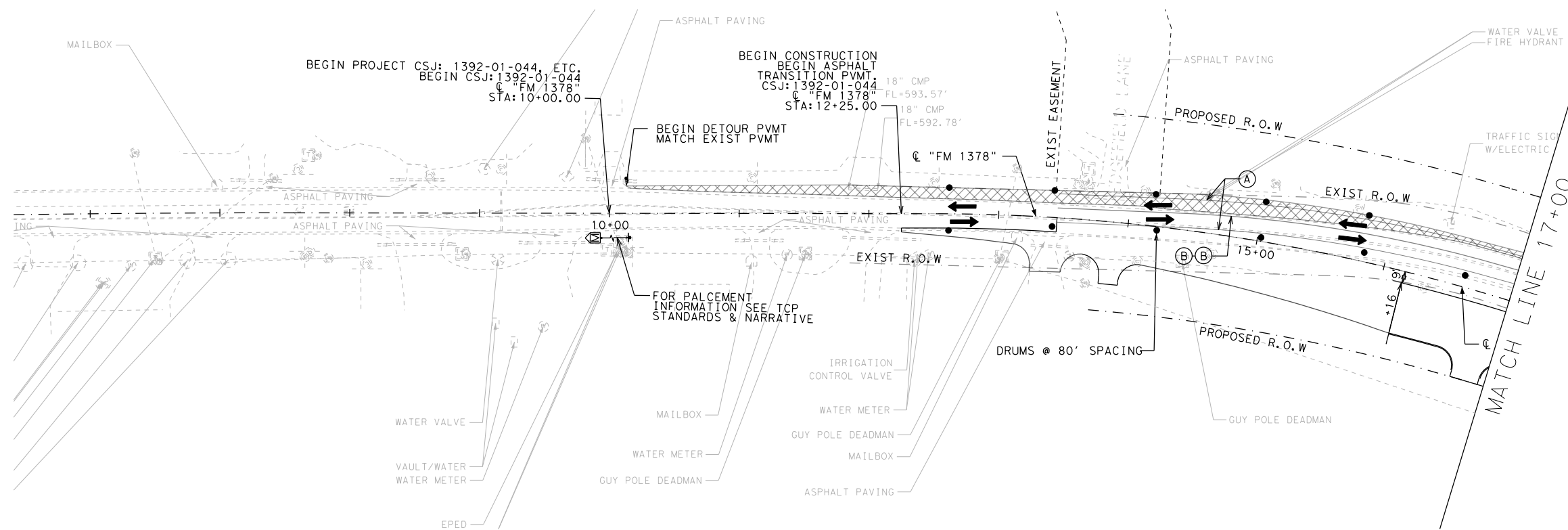

- LEGEND**
- EXISTING PAVEMENT
 - PERMANENT CONSTRUCTION THIS PHASE
 - PERMANENT CONSTRUCTION PREVIOUS PHASE
 - TEMPORARY PAVEMENT CONSTRUCTED THIS PHASE
 - TEMPORARY PAVEMENT CONSTRUCTED PREVIOUS PHASE
 - PORTABLE CONCRETE TRAFFIC BARRIER (PCTB)
 - CRASH CUSHION ATTENUATOR
 - LOW PROFILE CONCRETE BARRIER (LPCB)
 - SIGN POST
 - TYPE III BARRICADE
 - CHANNELIZATION DEVICES
 - DIRECTIONAL TRAFFIC FLOW ARROWS
 - WK ZN PAV MRK REMOV (W) 4" SLD
 - WK ZN PAV MRK REMOV (Y) 4" SLD
 - WK ZN PAV MRK NON-REMOV (W) 4" SLD
 - WK ZN PAV MRK NON-REMOV (Y) 4" SLD
 - WK ZN PAV MRK REMOV (W) 8" SLD
 - WK ZN PAV MRK REMOV (W) 24" SLD
 - MESSAGE BOARD
 - TEMPORARY SHORING

NOTES:
 TRAFFIC UTILIZES EXISTING PAVEMENT MARKINGS EXCEPT WHERE SHOWN
 CONTRACTOR IS RESPONSIBLE FOR MAINTAINING ADEQUATE DRAINAGE DURING CONSTRUCTION.
 CONTRACTOR TO COORDINATE WITH PROPERTY OWNERS TO PROVIDE FIELD ACCESS WHEN REQUESTED.
 REFER TO TCP MISC. DETAILS FOR DRIVEWAY & CROSS STREET CONSTRUCTION
 REFER TO TEMPORARY SIGNAL LAYOUT FOR TEMPORARY TRAFFIC CONFIGURATIONS AT INTERSECTIONS

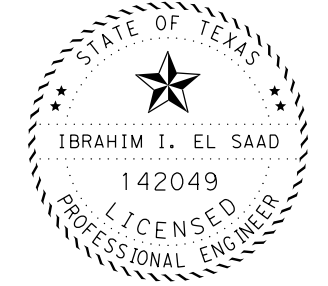

Abraham I. Saad, P.E., 2-16-23
 Signature of Registrant & Date

© 2023

FM 1378
AT FM 3286
TRAFFIC CONTROL PLAN
PHASE 1 STAGE 2

SCALE: 1"=100' SHEET 1 OF 5

DESIGN IIE	FED. RD. DIV. NO. 6	FEDERAL AID PROJECT NO. SEE TITLE SHEET		HIGHWAY NO. FM 1378, ETC.
GRAPHICS IIE	STATE TEXAS	DISTRICT DAL	COUNTY COLLIN	SHEET NO. 51
CHECK JI	CONTROL	SECTION	JOB	
CHECK JI	1392	01	044, ETC.	

DATE: 2/16/2023 TIME: 10:51:34 AM FILE: c:\txdot\pw\onl\ine\txdot5\ibrahim.e\saad\0326854\TCP PHASE 1 STAGE 2 PLAN SHEETS.dgn

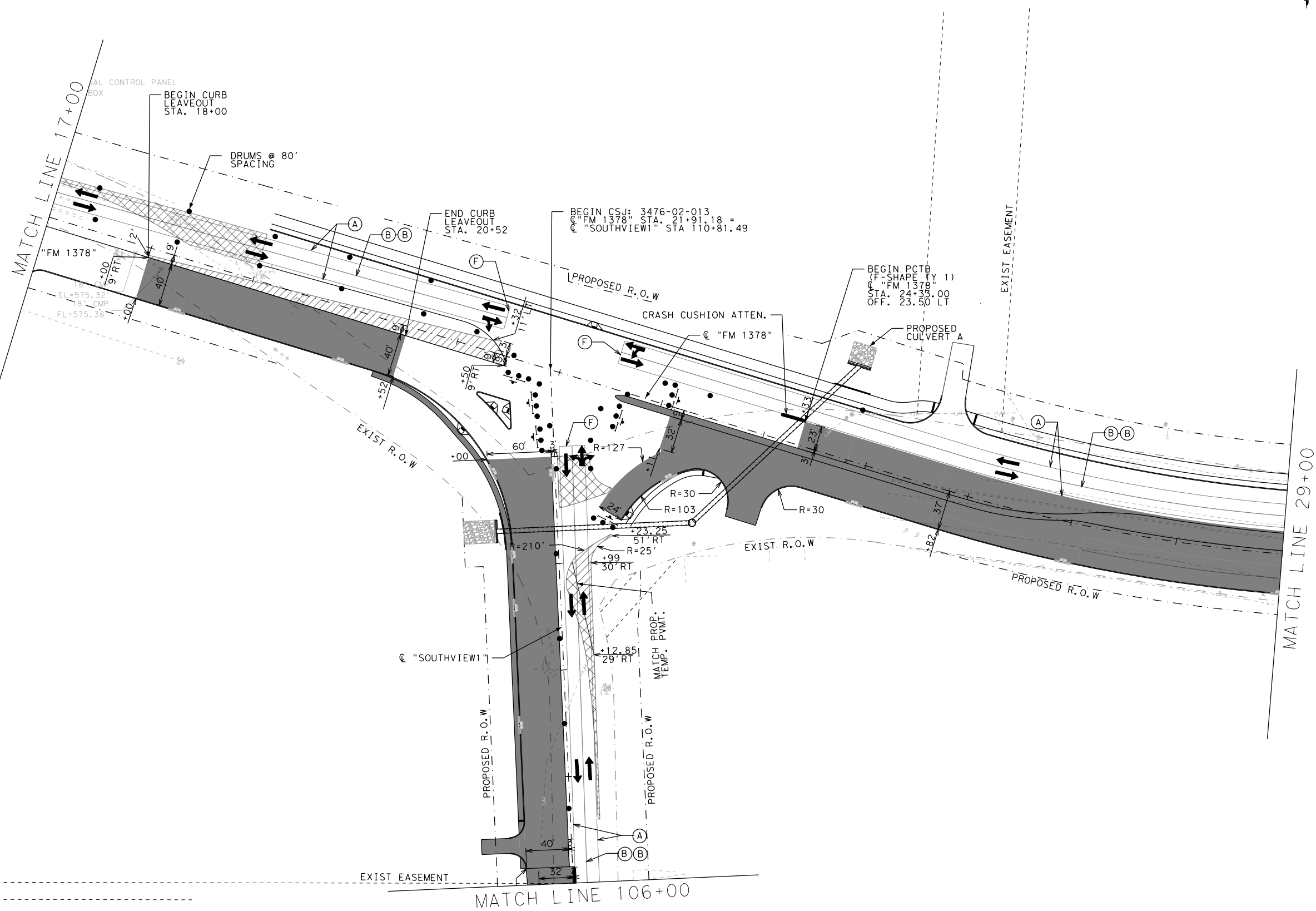

LEGEND

0 50 100

- EXISTING PAVEMENT
- PERMANENT CONSTRUCTION THIS PHASE
- PERMANENT CONSTRUCTION PREVIOUS PHASE
- TEMPORARY PAVEMENT CONSTRUCTED THIS PHASE
- TEMPORARY PAVEMENT CONSTRUCTED PREVIOUS PHASE
- PORTABLE CONCRETE TRAFFIC BARRIER (PCTB)
- CRASH CUSHION ATTENUATOR
- LOW PROFILE CONCRETE BARRIER (LPCB)
- SIGN POST
- TYPE III BARRICADE
- CHANNELIZATION DEVICES
- DIRECTIONAL TRAFFIC FLOW ARROWS
- WK ZN PAV MRK REMOV (W) 4" SLD
- WK ZN PAV MRK REMOV (Y) 4" SLD
- WK ZN PAV MRK NON-REMOV (W) 4" SLD
- WK ZN PAV MRK NON-REMOV (Y) 4" SLD
- WK ZN PAV MRK REMOV (W) 8" SLD
- WK ZN PAV MRK REMOV (W) 24" SLD
- MESSAGE BOARD
- TEMPORARY SHORING

NOTES:

TRAFFIC UTILIZES EXISTING PAVEMENT MARKINGS EXCEPT WHERE SHOWN

CONTRACTOR IS RESPONSIBLE FOR MAINTAINING ADEQUATE DRAINAGE DURING CONSTRUCTION.

CONTRACTOR TO COORDINATE WITH PROPERTY OWNERS TO PROVIDE FIELD ACCESS WHEN REQUESTED.

REFER TO TCP MISC. DETAILS FOR DRIVEWAY & CROSS STREET CONSTRUCTION

REFER TO TEMPORARY SIGNAL LAYOUT FOR TEMPORARY TRAFFIC CONFIGURATIONS AT INTERSECTIONS

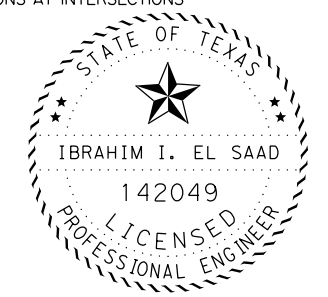

Abraham El Saad, P.E. 2-16-23
Signature of Registrant & Date

© 2023

Texas Department of Transportation

FM 1378
AT FM 3286
TRAFFIC CONTROL PLAN
PHASE 1 STAGE 2

SCALE: 1"=100' SHEET 2 OF 5

DESIGN IIE	FED. RD. DIV. NO. 6	FEDERAL AID PROJECT NO. SEE TITLE SHEET		HIGHWAY NO. FM 1378, ETC.
GRAPHICS IIE	STATE TEXAS	DISTRICT DAL	COUNTY COLLIN	SHEET NO. 52
CHECK JI	CONTROL	SECTION	JOB	
CHECK JI	1392	01	044, ETC.	

DATE: 2/16/2023 TIME: 10:51:37 AM FILE: c:\pwworking\isaad\isad\0326854\TCP PHASE 1 STAGE 2 PLAN SHEETS.dgn

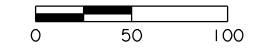
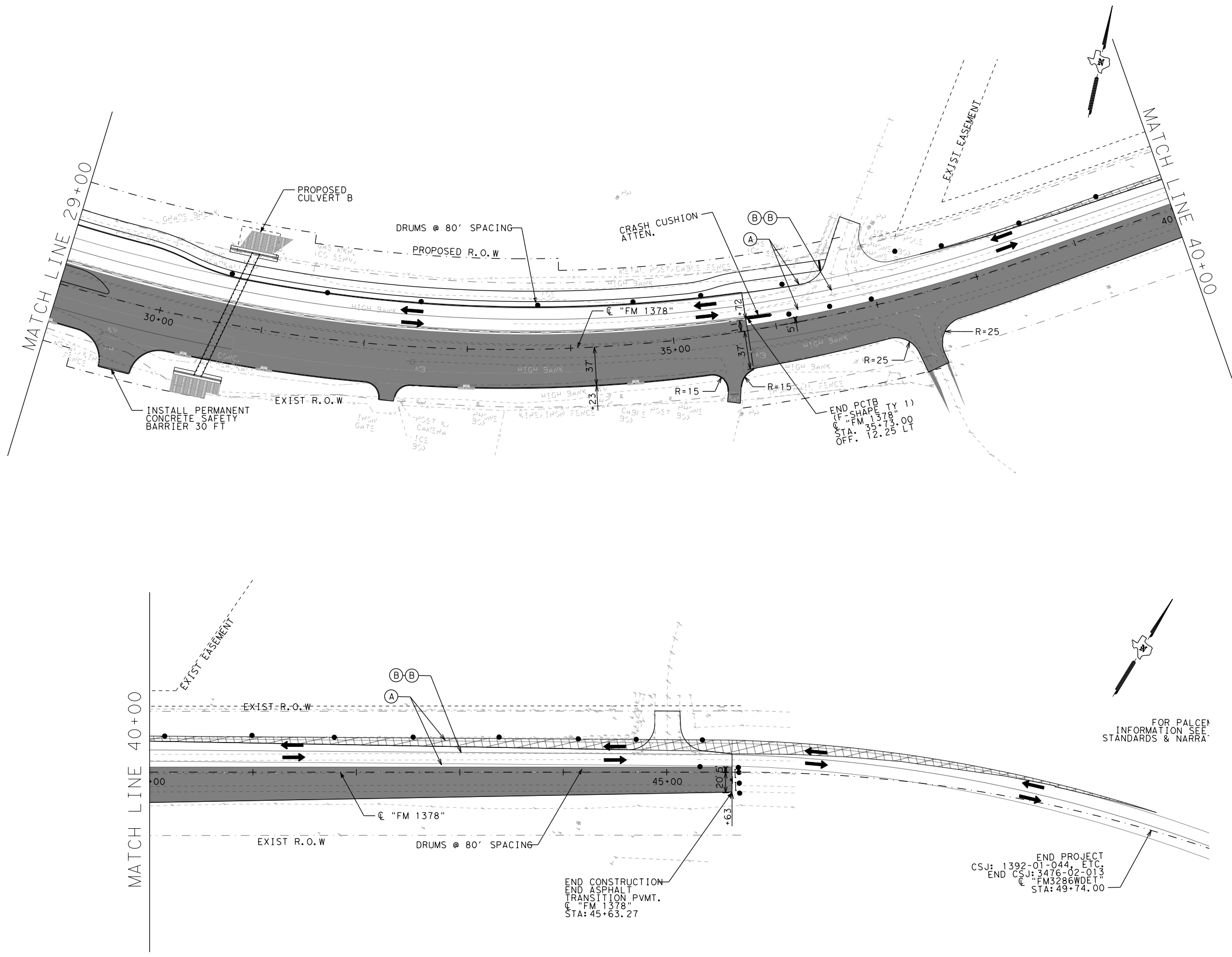

- LEGEND**
- EXISTING PAVEMENT
 - PERMANENT CONSTRUCTION THIS PHASE
 - PERMANENT CONSTRUCTION PREVIOUS PHASE
 - TEMPORARY PAVEMENT CONSTRUCTED THIS PHASE
 - TEMPORARY PAVEMENT CONSTRUCTED PREVIOUS PHASE
 - PORTABLE CONCRETE TRAFFIC BARRIER (PCTB)
 - CRASH CUSHION ATTENUATOR
 - LOW PROFILE CONCRETE BARRIER (LPCB)
 - SIGN POST
 - TYPE III BARRICADE
 - CHANNELIZATION DEVICES
 - DIRECTIONAL TRAFFIC FLOW ARROWS
 - WK ZN PAV MRK REMOV (W) 4" SLD
 - WK ZN PAV MRK REMOV (Y) 4" SLD
 - WK ZN PAV MRK NON-REMOV (W) 4" SLD
 - WK ZN PAV MRK NON-REMOV (Y) 4" SLD
 - WK ZN PAV MRK REMOV (W) 8" SLD
 - WK ZN PAV MRK REMOV (W) 24" SLD
 - MESSAGE BOARD
 - TEMPORARY SHORING

NOTES:

- TRAFFIC UTILIZES EXISTING PAVEMENT MARKINGS EXCEPT WHERE SHOWN
- CONTRACTOR IS RESPONSIBLE FOR MAINTAINING ADEQUATE DRAINAGE DURING CONSTRUCTION.
- CONTRACTOR TO COORDINATE WITH PROPERTY OWNERS TO PROVIDE FIELD ACCESS WHEN REQUESTED.
- REFER TO TCP MISC. DETAILS FOR DRIVEWAY & CROSS STREET CONSTRUCTION
- REFER TO TEMPORARY SIGNAL LAYOUT FOR TEMPORARY TRAFFIC CONFIGURATIONS AT INTERSECTIONS

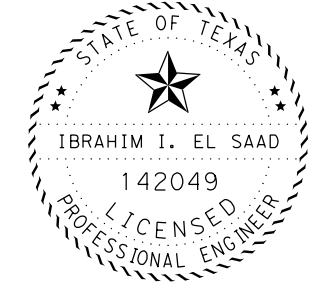

Abraham El Saad, P.E. 2-16-23
Signature of Registrant & Date

FOR PALCEN INFORMATION SEE STANDARDS & NARRA



**FM 1378
AT FM 3286
TRAFFIC CONTROL PLAN
PHASE 1 STAGE 2**

SCALE: 1"=100' SHEET 3 OF 5

DESIGN IIE	FED. RD. DIV. NO. 6	FEDERAL AID PROJECT NO. SEE TITLE SHEET		HIGHWAY NO. FM 1378, ETC.
GRAPHICS IIE	STATE TEXAS	DISTRICT DAL	COUNTY COLLIN	SHEET NO. 53
CHECK JI	CONTROL	SECTION	JOB	
CHECK JI	1392	01	044, ETC.	

DATE: 2/16/2023 TIME: 10:51:41 AM FILE: c:\xtdot\pw\on\line\xtdot5\ibrahim.eisaad\0326854\TCP PHASE 1 STAGE 2 PLAN SHEETS.dgn

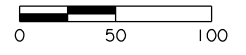
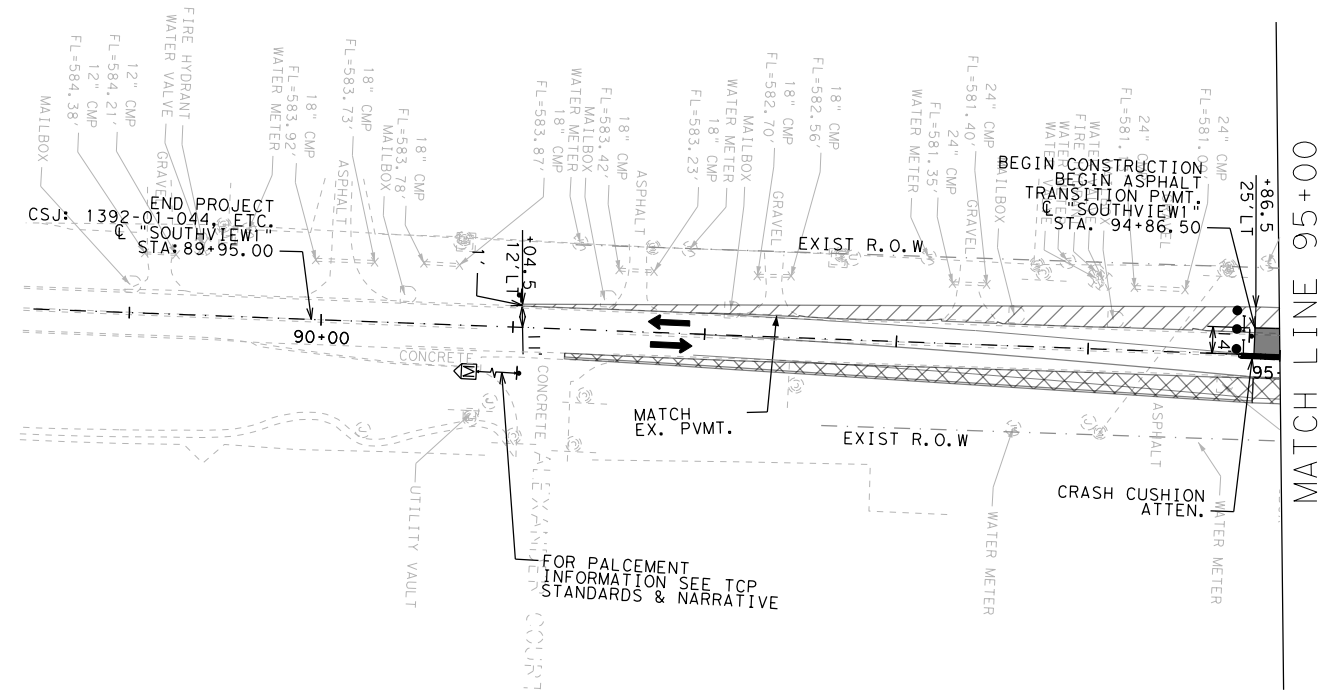
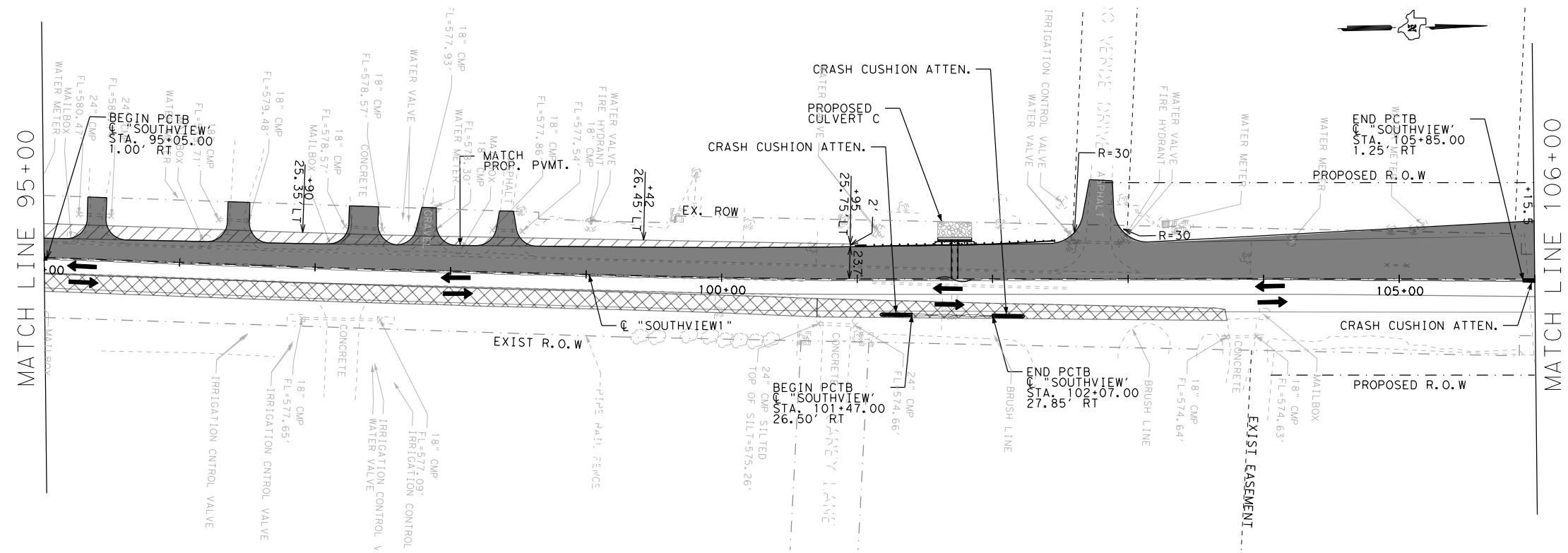

LEGEND

- EXISTING PAVEMENT
- PERMANENT CONSTRUCTION THIS PHASE
- PERMANENT CONSTRUCTION PREVIOUS PHASE
- TEMPORARY PAVEMENT CONSTRUCTED THIS PHASE
- TEMPORARY PAVEMENT CONSTRUCTED PREVIOUS PHASE
- PORTABLE CONCRETE TRAFFIC BARRIER (PCTB)
- CRASH CUSHION ATTENUATOR
- LOW PROFILE CONCRETE BARRIER (LPCB)
- SIGN POST
- TYPE III BARRICADE
- CHANNELIZATION DEVICES
- DIRECTIONAL TRAFFIC FLOW ARROWS
- WK ZN PAV MRK REMOV (W) 4" SLD
- WK ZN PAV MRK REMOV (Y) 4" SLD
- WK ZN PAV MRK NON-REMOV (W) 4" SLD
- WK ZN PAV MRK NON-REMOV (Y) 4" SLD
- WK ZN PAV MRK REMOV (W) 8" SLD
- WK ZN PAV MRK REMOV (W) 24" SLD
- MESSAGE BOARD
- TEMPORARY SHORING

NOTES:
 TRAFFIC UTILIZES EXISTING PAVEMENT MARKINGS EXCEPT WHERE SHOWN

CONTRACTOR IS RESPONSIBLE FOR MAINTAINING ADEQUATE DRAINAGE DURING CONSTRUCTION.

CONTRACTOR TO COORDINATE WITH PROPERTY OWNERS TO PROVIDE FIELD ACCESS WHEN REQUESTED.

REFER TO TCP MISC. DETAILS FOR DRIVEWAY & CROSS STREET CONSTRUCTION

REFER TO TEMPORARY SIGNAL LAYOUT FOR TEMPORARY TRAFFIC CONFIGURATIONS AT INTERSECTIONS

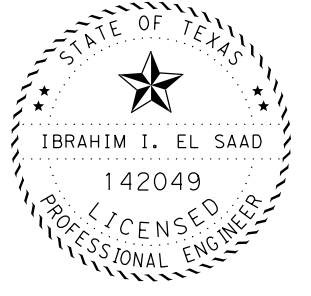

Abraham El Saad, P.E. 2-16-23
 Signature of Registrant & Date

				© 2023
FM 1378				
AT FM 3286				
TRAFFIC CONTROL PLAN				
PHASE 1 STAGE 2				
SCALE: 1"=100'		SHEET 4 OF 5		
DESIGN IIE	FED. RD. DIV. NO. 6	FEDERAL AID PROJECT NO. SEE TITLE SHEET	HIGHWAY NO. FM 1378, ETC.	
GRAPHICS IIE	STATE TEXAS	DISTRICT DAL	COUNTY COLLIN	
CHECK JI	CONTROL	SECTION	JOB	
CHECK JI	1392	01	044, ETC.	
			54	

FILE: c:\txdot\pwworking\ibrahim.elsaad\0326854\TCP PHASE 1 STAGE 2 PLAN SHEETS.dgn
 DATE: 2/16/2023
 TIME: 10:51:43 AM

SUMMARY OF TCP QUANTITIES CSJ: 1392-01-044

ITEM #	DESCRIPTION	UNIT	SHEET TOTAL
400-6008	CUT & RESTORE ASPH PAVING	SY	240
403-6001	TEMPORARY SPL SHORING	SF	233
508-6001	CONSTRUCTING DETOURS	SY	1309
512-6005	PORT CTB (FUR&INST)(F-SHAPE)(TY 1)	LF	1140
512-6053	PORT CTB (REMOVE)(F-SHAPE)(TY 1)	LF	60
545-6003	CRASH CUSH ATTEN (MOVE & RESET)	EA	2
545-6005	CRASH CUSH ATTEN (REMOVE)	EA	2
545-6019	CRASH CUSH ATTEN (INSTL)(S)(N)(TL3)	EA	2
662-6063	WK ZN PAV MRK REMOV (W) 4" (SLD)	LF	5222
662-6075	WK ZN PAV MRK REMOV (W)24"(SLD)	LF	44
662-6095	WK ZN PAV MRK REMOVE (Y) 4" (SLD)	LF	5225
677-6001	ELIM EXT PAV MRK & MRKS (4")	LF	2211
677-6007	ELIM EXT PAV MRK & MRKS (24")	LF	22

TCP DETOUR QUANTITIES (1392-01-044)

ITEM #	DESCRIPTION	UNIT	SHEET TOTAL
260-6016	LIME (HYD, COM, OR QK(SLURRY))	TON	22
260-6027	LIME TRT (EXST MATL) (8")	SY	1309
3077-6001	4" SP MIXES SP-B PG64-22	TON	288
3077-6013	2" SP MIXES SP-C SAC-B PG64-22	TON	144

NOTE: FOR CONTRCTOR'S INFORMATION ONLY. DETOURS WILL BE PAID FOR IN ACCORDANCE TO ITEM 508-6001.

SUMMARY OF TCP QUANTITIES CSJ: 3476-02-013

ITEM #	DESCRIPTION	UNIT	SHEET TOTAL
512-6005	PORT CTB (FUR&INST)(F-SHAPE)(TY 1)	LF	240
512-6029	PORT CTB (MOVE)(F-SHAPE)(TY 1)	LF	900
512-6053	PORT CTB (REMOVE)(F-SHAPE)(TY 1)	LF	1140
545-6003	CRASH CUSH ATTEN (MOVE & RESET)	EA	2
545-6005	CRASH CUSH ATTEN (REMOVE)	EA	2
662-6063	WK ZN PAV MRK REMOV (W) 4" (SLD)	LF	5656
662-6075	WK ZN PAV MRK REMOV (W)24"(SLD)	LF	22
662-6095	WK ZN PAV MRK REMOVE (Y) 4" (SLD)	LF	5656
677-6001	ELIM EXT PAV MRK & MRKS (4")	LF	7966

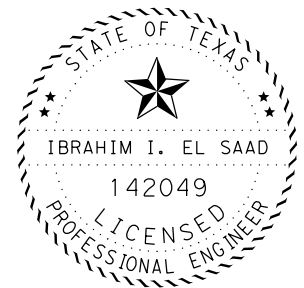

Abraham I. Saad, P.E. 2-16-23
Signature of Registrant & Date



© 2023

FM 1378
AT FM 3286
SUMMARY OF QUANTITIES
PHASE 1 STAGE 2

SCALE: 1"=100' SHEET 5 OF 5

DESIGN	FED. RD. DIV. NO.	FEDERAL AID PROJECT NO.		HIGHWAY NO.
IIE	6	SEE TITLE SHEET		FM 1378, ETC.
GRAPHICS	IIE	STATE	DISTRICT	COUNTY
CHECK	J1	TEXAS	DAL	COLLIN
CHECK	J1	CONTROL	SECTION	JOB
		1392	01	044, ETC.

55

DATE: 2/16/2023 TIME: 10:51:49 AM FILE: c:\txdot\pw\online\txdot5\ibrahim.elsaad\d0326854\TCP Typical Sections Sheets P2S1.dgn

- LEGEND**
- PERMANENT CONSTRUCTION THIS PHASE
 - PERMANENT CONSTRUCTION PREVIOUS PHASE
 - ▨ DETOUR PAVEMENT
 - Ⓐ - 2" SUPERPAVE MIXTURES (SP-C) (PG64-22)
 - Ⓑ - 4" SUPERPAVE MIXTURES (SP-B) (PG64-22)
 - Ⓒ - 8" LTS WITH 5% LIME (EXIST)

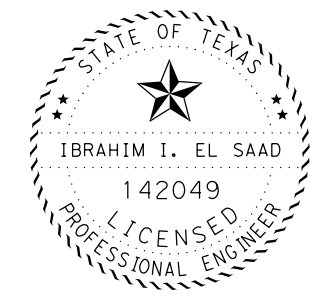
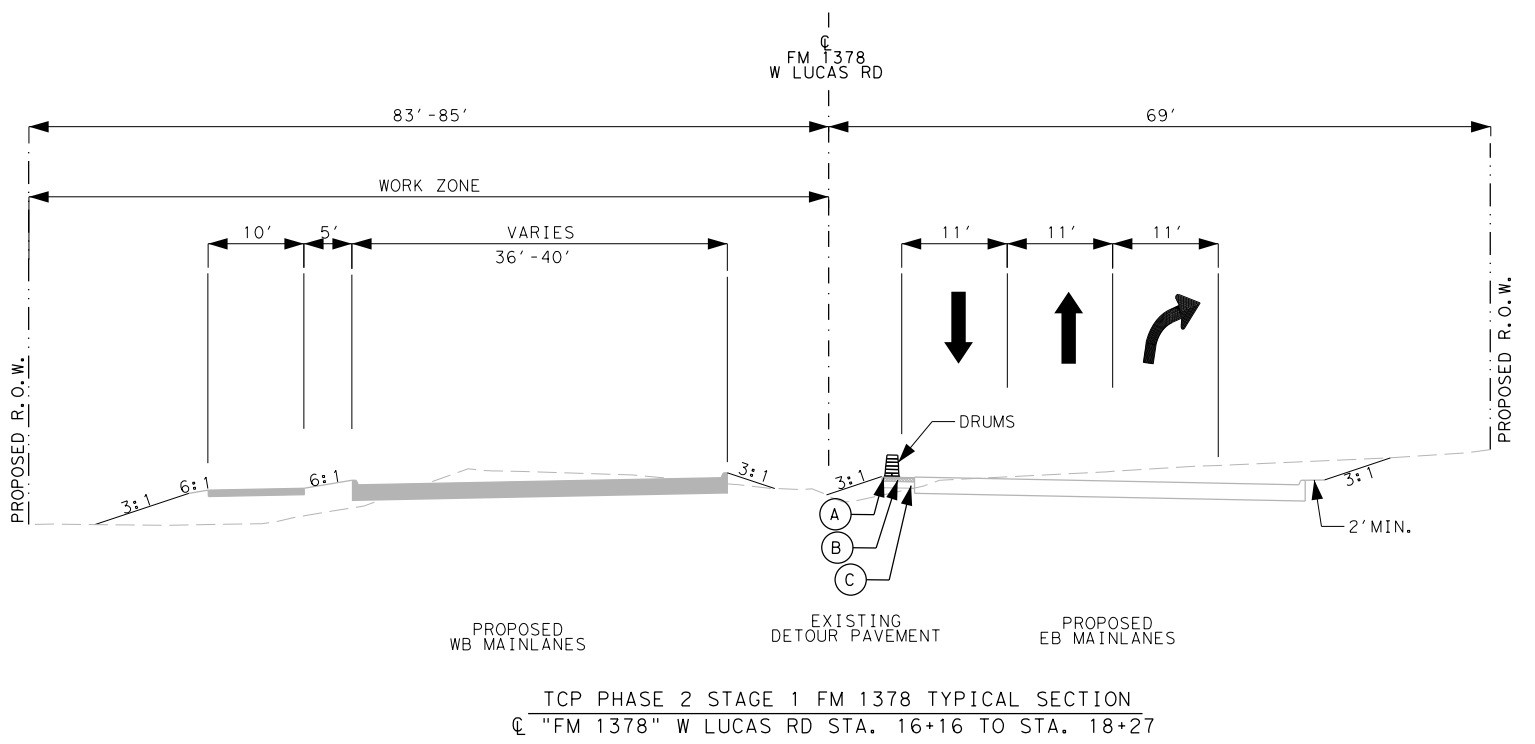
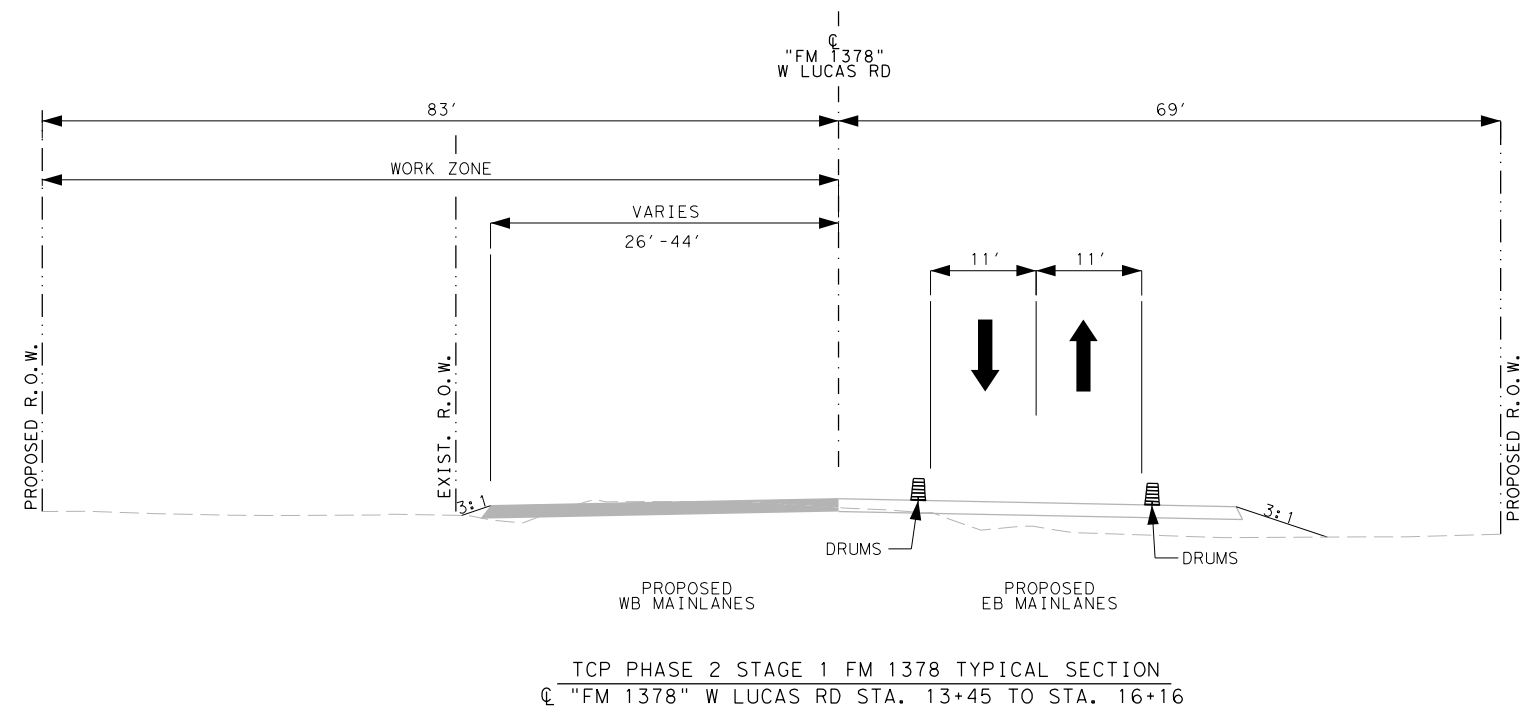

Ibrahim I. El Saad, P.E. 2-16-23
 Signature of Registrant & Date

				© 2023
FM 1378				
AT FM 3286				
TRAFFIC CONTROL PLAN				
PHASE 2 STAGE 1				
TYPICAL SECTION				
SHEET 1 OF 3				
DESIGN IIE	FED. RD. DIV. NO.	FEDERAL AID PROJECT NO.		HIGHWAY NO.
GRAPHICS IIE	6	SEE TITLE SHEET		FM 1378, ETC.
CHECK JI	STATE	DISTRICT	COUNTY	SHEET NO.
CHECK JI	TEXAS	DAL	COLLIN	56
CHECK JI	CONTROL	SECTION	JOB	
CHECK JI	1392	01	044, ETC.	

DATE: 2/16/2023 TIME: 10:51:50 AM FILE: c:\txdot\pw\onl\ine\txdot5\ibrahim.elsaad\d0326854\TCP Typical Sections Sheets P2S1.dgn

- LEGEND**
- PERMANENT CONSTRUCTION THIS PHASE
 - PERMANENT CONSTRUCTION PREVIOUS PHASE
 - ▬ DETOUR PAVEMENT
 - Ⓐ - 2" SUPERPAVE MIXTURES (SP-C) (PG64-22)
 - Ⓑ - 4" SUPERPAVE MIXTURES (SP-B) (PG64-22)
 - Ⓒ - 8" LTS WITH 5% LIME (EXIST)

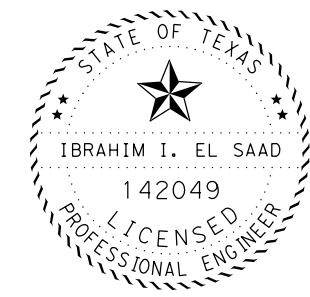
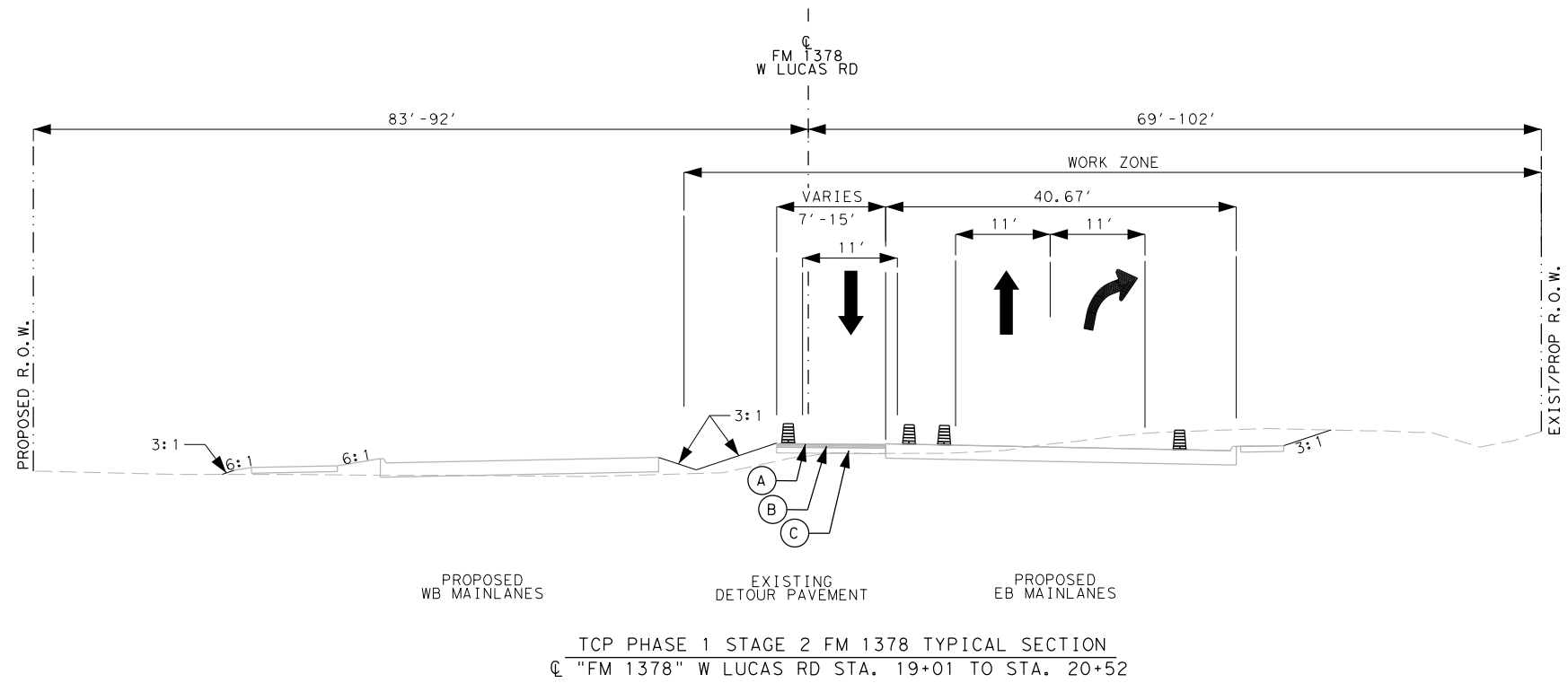
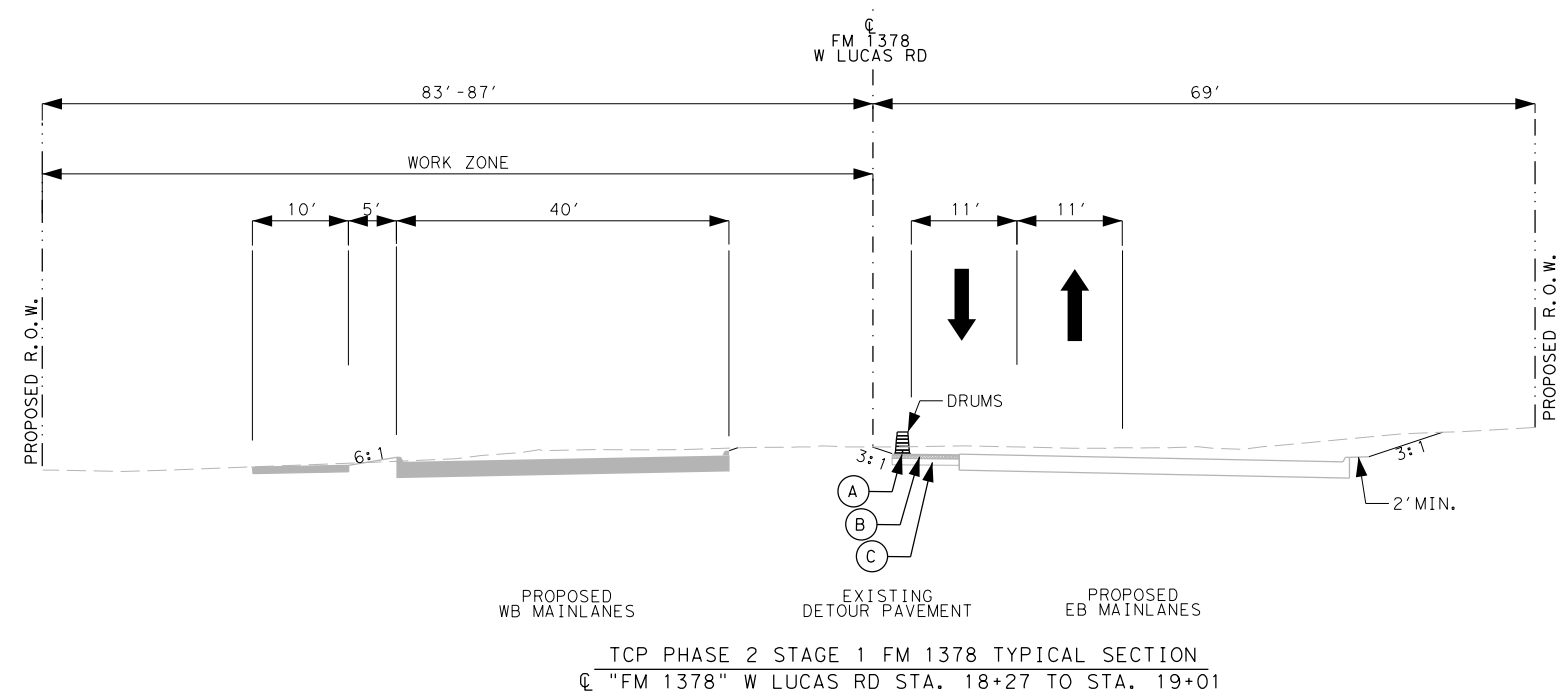

Ibrahim I. El Saad, P.E. 2-16-23
 Signature of Registrant & Date

				© 2023
FM 1378				
AT FM 3286				
TRAFFIC CONTROL PLAN				
PHASE 2 STAGE 1				
TYPICAL SECTION				
SHEET 2 OF 3				
DESIGN IIE	FED. RD. DIV. NO. 6	FEDERAL AID PROJECT NO. SEE TITLE SHEET		
GRAPHICS IIE	STATE TEXAS	DISTRICT DAL	COUNTY COLLIN	
CHECK JI	CONTROL	SECTION	JOB	
CHECK JI	1392	01	044, ETC.	
			57	

DATE: 2/16/2023 TIME: 10:51:52 AM FILE: c:\txdot\pw\onl\ine\txdot5\ibrahim.elsaad\d0326854\TCP Typical Sections Sheets P2S1.dgn

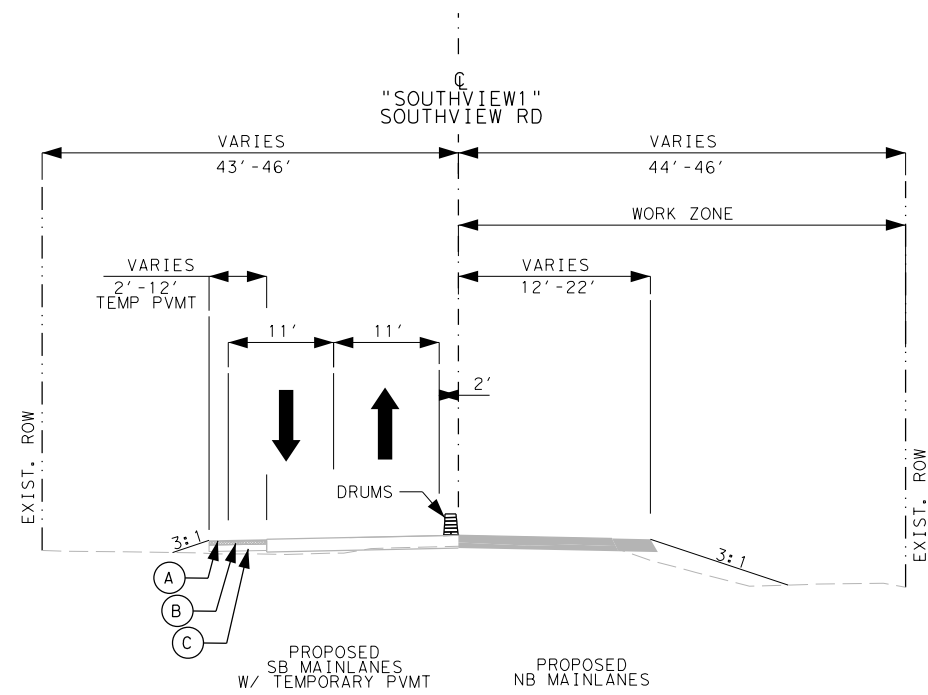

TCP PHASE 2 STAGE 1 FM 1378 TYPICAL SECTION
 @ "SOUTHVIEW1" SOUTHVIEW RD - STA. 94+86 TO STA. 99+52

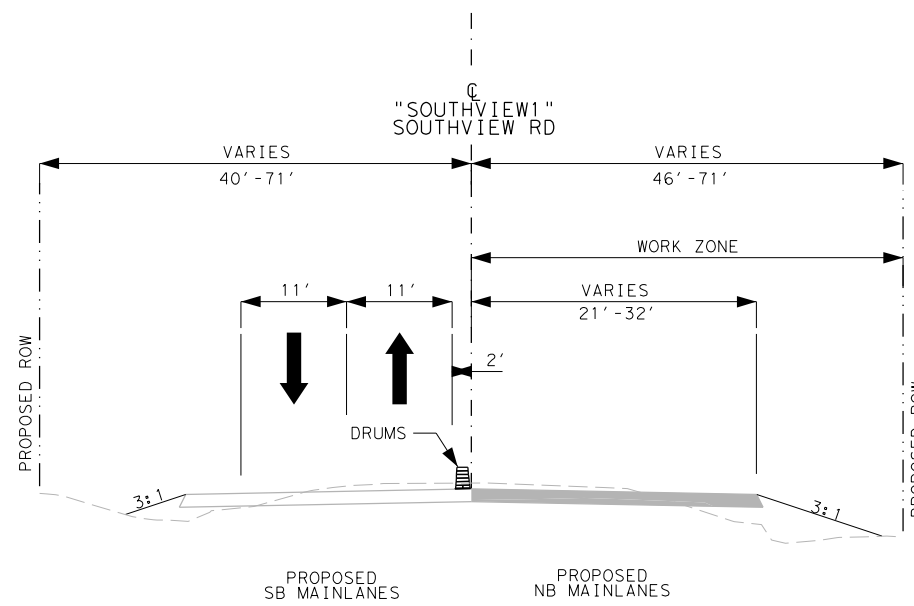

TCP PHASE 2 STAGE 1 FM 1378 TYPICAL SECTION
 @ "SOUTHVIEW1" SOUTHVIEW RD - STA. 99+52 TO STA. 106+15

- LEGEND
- PERMANENT CONSTRUCTION THIS PHASE
 - PERMANENT CONSTRUCTION PREVIOUS PHASE
 - ▨ DETOUR PAVEMENT
 - A - 2" SUPERPAVE MIXTURES (SP-C) (PG64-22)
 - B - 4" SUPERPAVE MIXTURES (SP-B) (PG64-22)
 - C - 8" LTS WITH 5% LIME (EXIST)

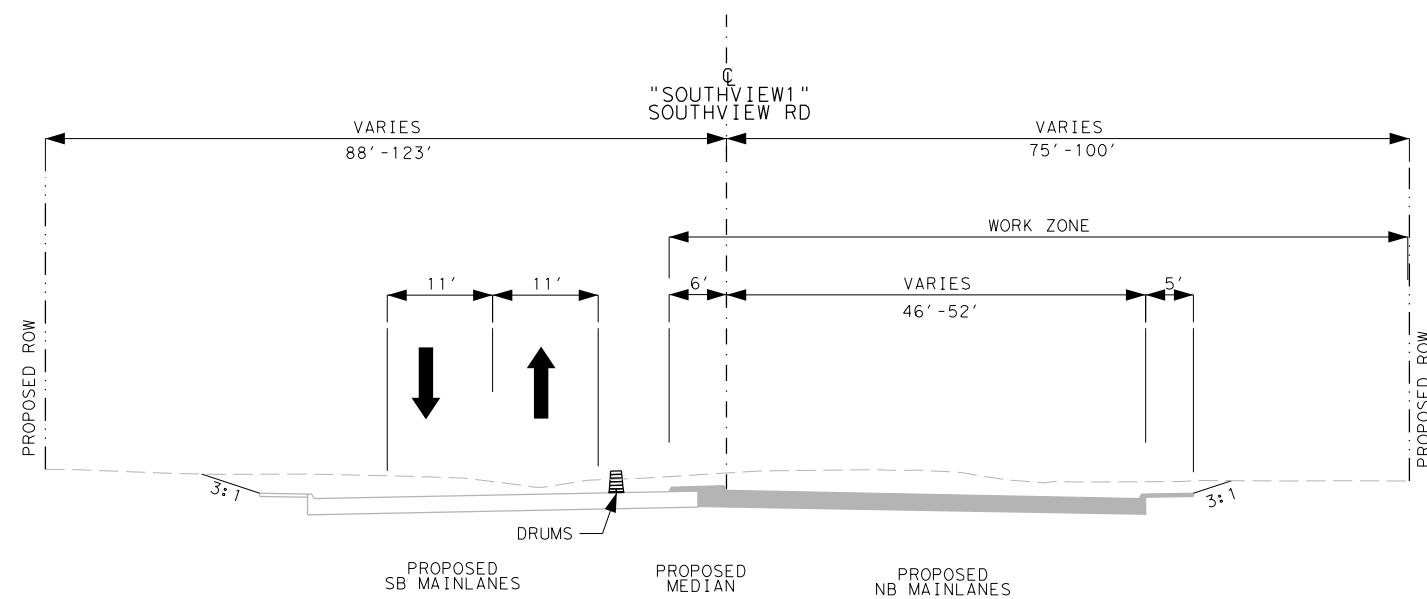

TCP PHASE 2 STAGE 1 FM 1378 TYPICAL SECTION
 @ "SOUTHVIEW1" SOUTHVIEW RD - STA. 106+15 TO STA. 110+00

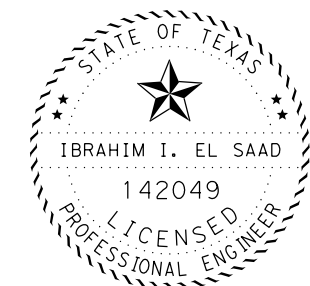

Abraham El Saad, P.E. 2-16-23
 Signature of Registrant & Date

© 2023

Texas Department of Transportation

FM 1378
AT FM 3286
TRAFFIC CONTROL PLAN
PHASE 2 STAGE 1
TYPICAL SECTION

SHEET 3 OF 3

DESIGN IIE	FED. RD. DIV. NO. 6	FEDERAL AID PROJECT NO. SEE TITLE SHEET		HIGHWAY NO. FM 1378, ETC.
GRAPHICS IIE	STATE TEXAS	DISTRICT DAL	COUNTY COLLIN	SHEET NO. 58
CHECK JI	CONTROL 1392	SECTION 01	JOB 044, ETC.	

DATE: 2/16/2023 TIME: 11:40:05 AM FILE: c:\t\dot\pw*on\ine\t\dot+5\ibrahim.e\saad\0326854\TCP_PHASE_2_STAGE_1_PLAN_SHEETS.dgn

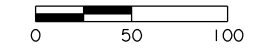
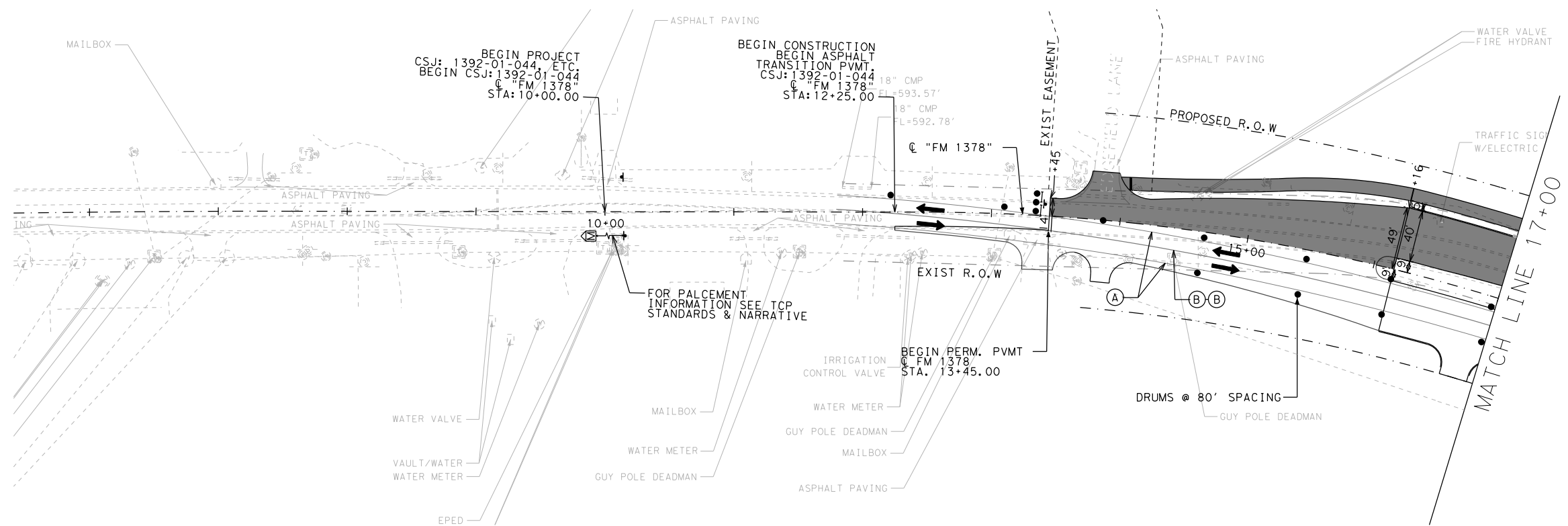

LEGEND

- EXISTING PAVEMENT
- PERMANENT CONSTRUCTION THIS PHASE
- PERMANENT CONSTRUCTION PREVIOUS PHASE
- TEMPORARY PAVEMENT CONSTRUCTED THIS PHASE
- TEMPORARY PAVEMENT CONSTRUCTED PREVIOUS PHASE
- PORTABLE CONCRETE TRAFFIC BARRIER (PCTB)
- CRASH CUSHION ATTENUATOR
- LOW PROFILE CONCRETE BARRIER (LPCB)
- SIGN POST
- TYPE III BARRICADE
- CHANNELIZATION DEVICES
- DIRECTIONAL TRAFFIC FLOW ARROWS
- WK ZN PAV MRK REMOV (W) 4" SLD
- WK ZN PAV MRK REMOV (Y) 4" SLD
- WK ZN PAV MRK NON-REMOV (W) 4" SLD
- WK ZN PAV MRK NON-REMOV (Y) 4" SLD
- WK ZN PAV MRK REMOV (W) 8" SLD
- WK ZN PAV MRK REMOV (W) 24" SLD
- MESSAGE BOARD
- TEMPORARY SHORING

NOTES:

- TRAFFIC UTILIZES EXISTING PAVEMENT MARKINGS EXCEPT WHERE SHOWN
- CONTRACTOR IS RESPONSIBLE FOR MAINTAINING ADEQUATE DRAINAGE DURING CONSTRUCTION.
- CONTRACTOR TO COORDINATE WITH PROPERTY OWNERS TO PROVIDE FIELD ACCESS WHEN REQUESTED.
- REFER TO TCP MISC. DETAILS FOR DRIVEWAY & CROSS STREET CONSTRUCTION
- REFER TO TEMPORARY SIGNAL LAYOUT FOR TEMPORARY TRAFFIC CONFIGURATIONS AT INTERSECTIONS

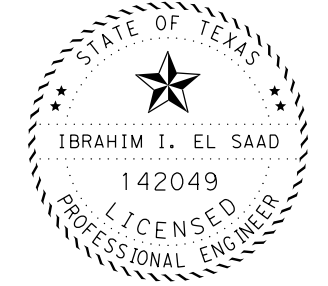

Abraham El Saad, P.E. 2-16-23
Signature of Registrant & Date

© 2023

FM 1378
AT FM 3286
TRAFFIC CONTROL PLAN
PHASE 2 STAGE 1

SCALE: 1"=100' SHEET 1 OF 5

DESIGN IIE	FED. RD. DIV. NO. 6	FEDERAL AID PROJECT NO. SEE TITLE SHEET		HIGHWAY NO. FM 1378, ETC.
GRAPHICS IIE	STATE TEXAS	DISTRICT DAL	COUNTY COLLIN	SHEET NO. 59
CHECK JI	CONTROL	SECTION	JOB	
CHECK JI	1392	01	044, ETC.	

FILE: c:\xtdot\pw\onl\ine\xtdot5\ibrahim.e\saad\0326854\TCP_PHASE_2_STAGE_1_PLAN_SHEETS.dgn
 TIME: 11:40:08 AM
 DATE: 2/16/2023

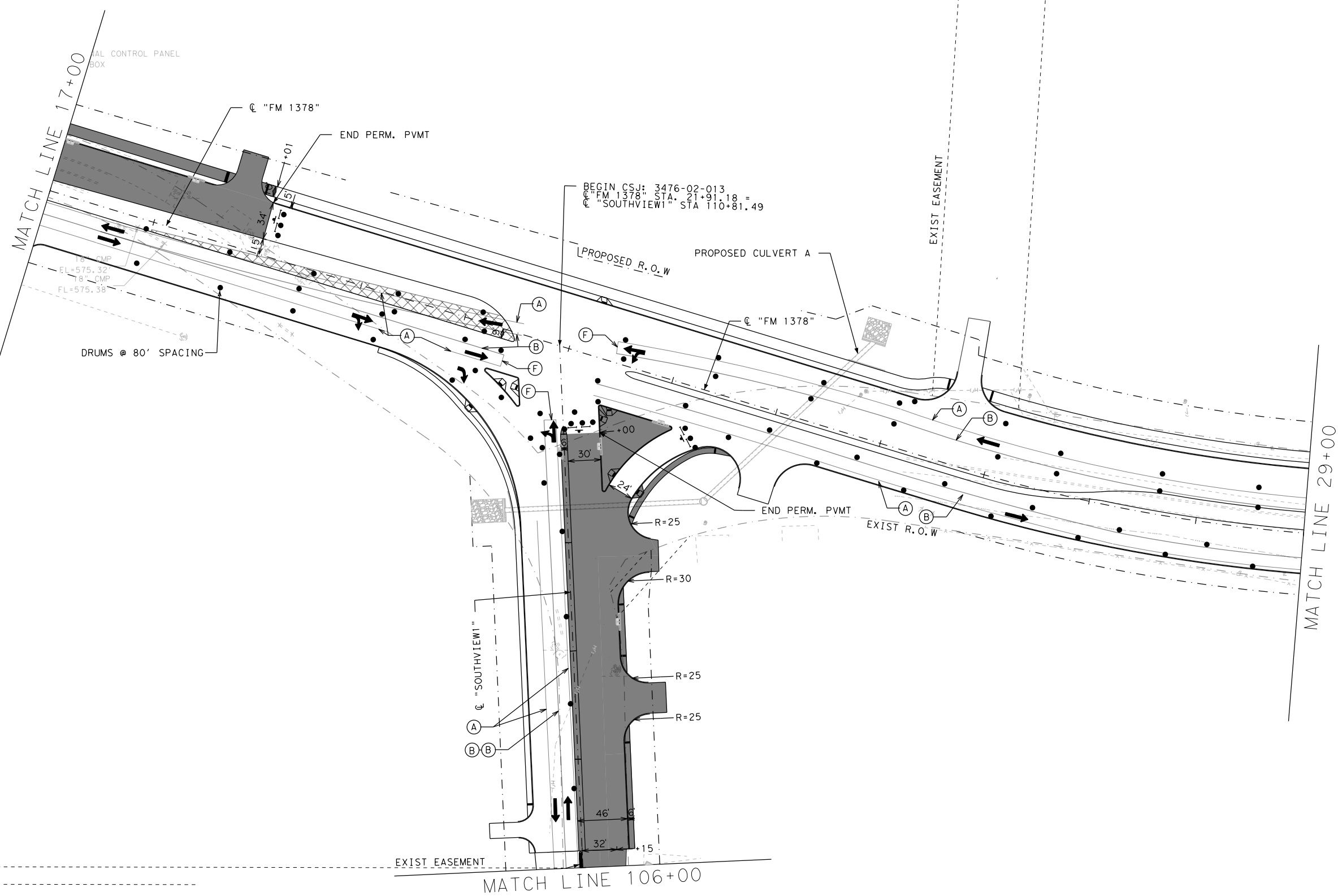

LEGEND

0 50 100

- EXISTING PAVEMENT
- PERMANENT CONSTRUCTION THIS PHASE
- PERMANENT CONSTRUCTION PREVIOUS PHASE
- TEMPORARY PAVEMENT CONSTRUCTED THIS PHASE
- TEMPORARY PAVEMENT CONSTRUCTED PREVIOUS PHASE
- PORTABLE CONCRETE TRAFFIC BARRIER (PCTB)
- CRASH CUSHION ATTENUATOR
- LOW PROFILE CONCRETE BARRIER (LPCB)
- SIGN POST
- TYPE III BARRICADE
- CHANNELIZATION DEVICES
- DIRECTIONAL TRAFFIC FLOW ARROWS
- WK ZN PAV MRK REMOV (W) 4" SLD
- WK ZN PAV MRK REMOV (Y) 4" SLD
- WK ZN PAV MRK NON-REMOV (W) 4" SLD
- WK ZN PAV MRK NON-REMOV (Y) 4" SLD
- WK ZN PAV MRK REMOV (W) 8" SLD
- WK ZN PAV MRK REMOV (W) 24" SLD
- MESSAGE BOARD
- TEMPORARY SHORING

NOTES:
 TRAFFIC UTILIZES EXISTING PAVEMENT MARKINGS EXCEPT WHERE SHOWN

CONTRACTOR IS RESPONSIBLE FOR MAINTAINING ADEQUATE DRAINAGE DURING CONSTRUCTION.

CONTRACTOR TO COORDINATE WITH PROPERTY OWNERS TO PROVIDE FIELD ACCESS WHEN REQUESTED.

REFER TO TCP MISC. DETAILS FOR DRIVEWAY & CROSS STREET CONSTRUCTION

REFER TO TEMPORARY SIGNAL LAYOUT FOR TEMPORARY TRAFFIC CONFIGURATIONS AT INTERSECTIONS

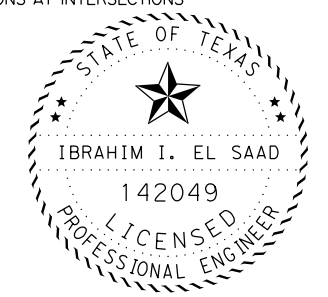

Abraham I. Saad, P.E. 2-16-23
 Signature of Registrant & Date

© 2023

Texas Department of Transportation

FM 1378
AT FM 3286
TRAFFIC CONTROL PLAN
PHASE 2 STAGE 1

SCALE: 1"=100' SHEET 2 OF 5

DESIGN IIE	FED. RD. DIV. NO. 6	FEDERAL AID PROJECT NO. SEE TITLE SHEET		HIGHWAY NO. FM 1378, ETC.
GRAPHICS IIE	STATE TEXAS	DISTRICT DAL	COUNTY COLLIN	SHEET NO. 60
CHECK JI	CONTROL	SECTION	JOB	
CHECK JI	1392	01	044, ETC.	

DATE: 2/16/2023 TIME: 11:40:12 AM FILE: c:\txdot\pw\onl\ine\txdot5\ibrahim.e\saad\0326854\TCP PHASE 2 STAGE 1 PLAN SHEETS.dgn

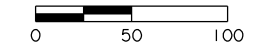
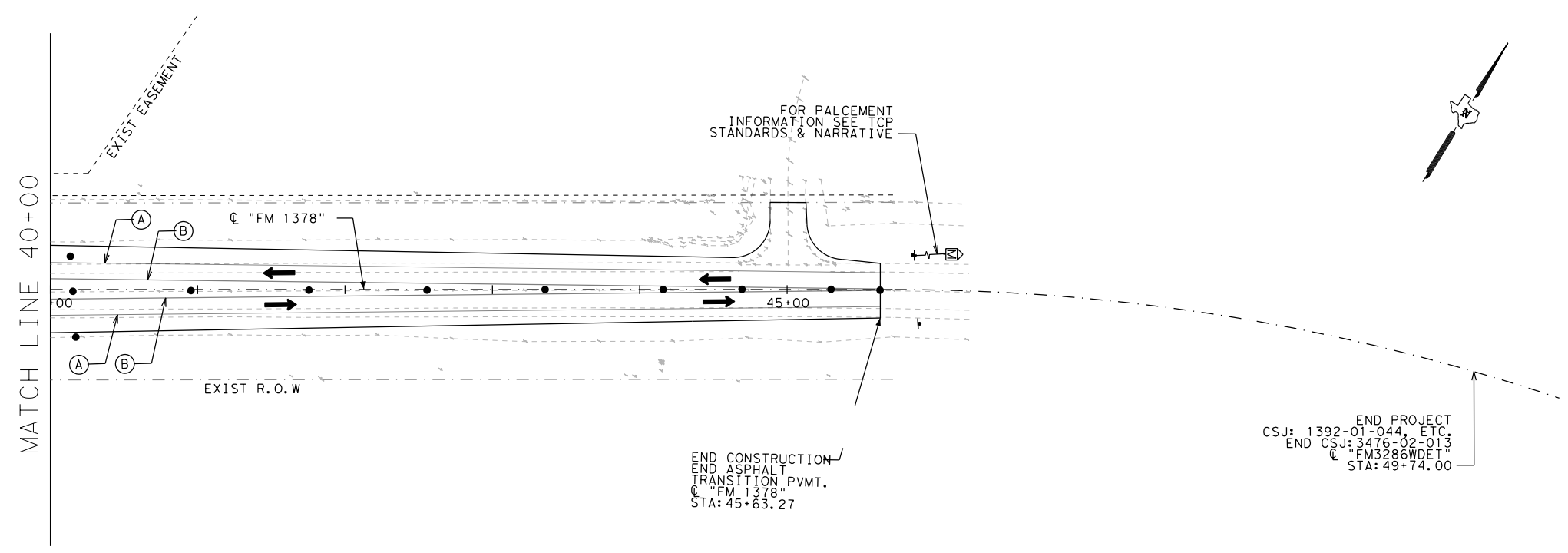
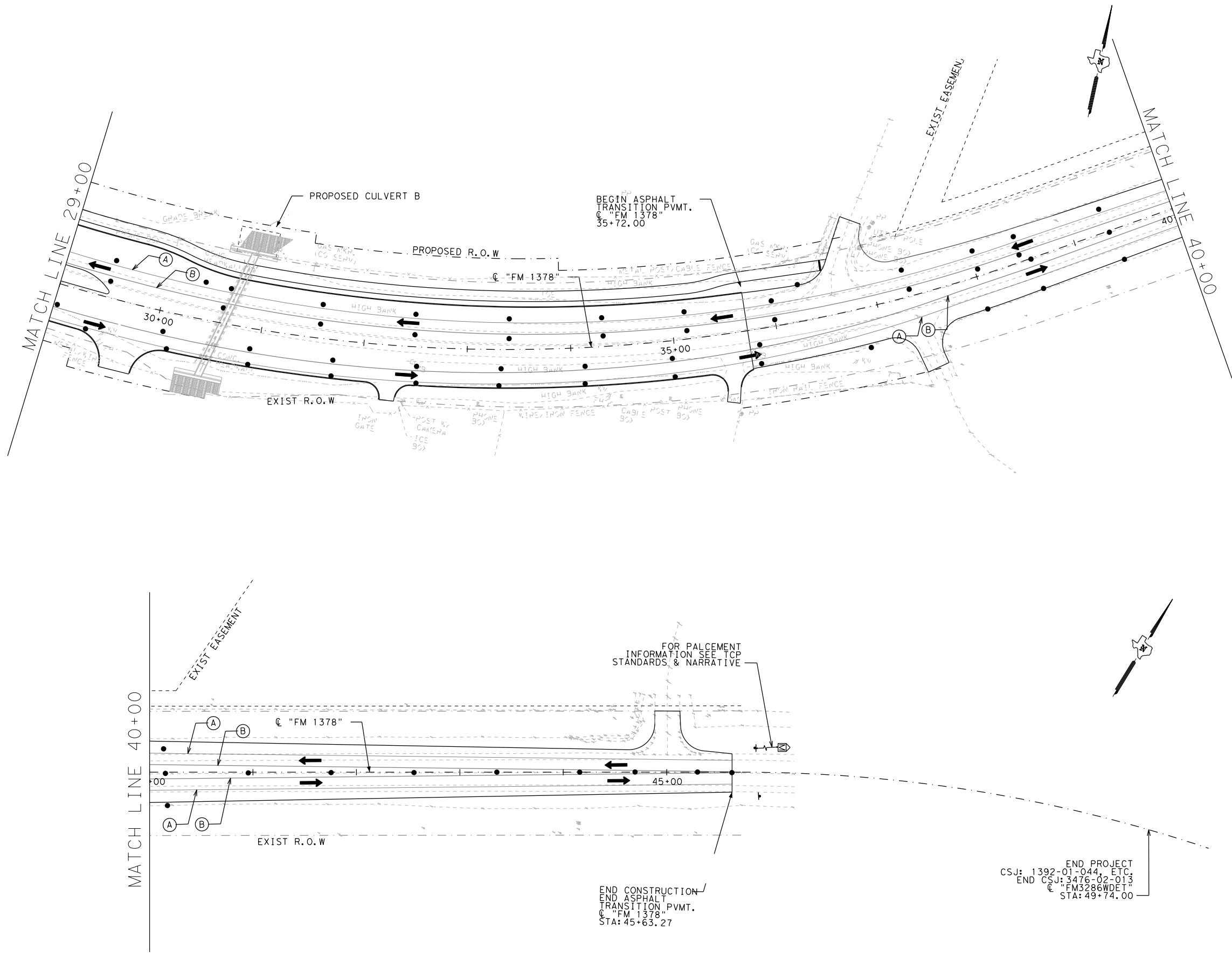

- LEGEND
- EXISTING PAVEMENT
 - PERMANENT CONSTRUCTION THIS PHASE
 - PERMANENT CONSTRUCTION PREVIOUS PHASE
 - TEMPORARY PAVEMENT CONSTRUCTED THIS PHASE
 - TEMPORARY PAVEMENT CONSTRUCTED PREVIOUS PHASE
 - PORTABLE CONCRETE TRAFFIC BARRIER (PCTB)
 - CRASH CUSHION ATTENUATOR
 - LOW PROFILE CONCRETE BARRIER (LPCB)
 - SIGN POST
 - TYPE III BARRICADE
 - CHANNELIZATION DEVICES
 - DIRECTIONAL TRAFFIC FLOW ARROWS
 - WK ZN PAV MRK REMOV (W) 4" SLD
 - WK ZN PAV MRK REMOV (Y) 4" SLD
 - WK ZN PAV MRK NON-REMOV (W) 4" SLD
 - WK ZN PAV MRK NON-REMOV (Y) 4" SLD
 - WK ZN PAV MRK REMOV (W) 8" SLD
 - WK ZN PAV MRK REMOV (W) 24" SLD
 - MESSAGE BOARD
 - TEMPORARY SHORING

NOTES:
 TRAFFIC UTILIZES EXISTING PAVEMENT MARKINGS EXCEPT WHERE SHOWN

CONTRACTOR IS RESPONSIBLE FOR MAINTAINING ADEQUATE DRAINAGE DURING CONSTRUCTION.

CONTRACTOR TO COORDINATE WITH PROPERTY OWNERS TO PROVIDE FIELD ACCESS WHEN REQUESTED.

REFER TO TCP MISC. DETAILS FOR DRIVEWAY & CROSS STREET CONSTRUCTION

REFER TO TEMPORARY SIGNAL LAYOUT FOR TEMPORARY TRAFFIC CONFIGURATIONS AT INTERSECTIONS

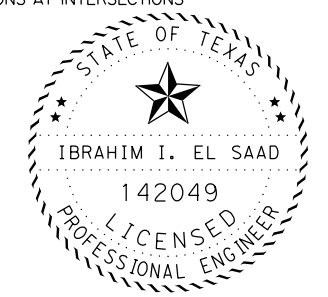

Abraham El Saad, P.E. 2-16-23
 Signature of Registrant & Date

© 2023

Texas Department of Transportation

FM 1378
AT FM 3286
TRAFFIC CONTROL PLAN
PHASE 2 STAGE 1

SCALE: 1"=100' SHEET 3 OF 5

DESIGN	FED. RD. DIV. NO.	FEDERAL AID PROJECT NO.		HIGHWAY NO.
IIE	6	SEE TITLE SHEET		FM 1378, ETC.
GRAPHICS	STATE	DISTRICT	COUNTY	SHEET NO.
IIE	TEXAS	DAL	COLLIN	61
CHECK	CONTROL	SECTION	JOB	
J1	1392	01	044, ETC.	

DATE: 2/16/2023 TIME: 11:40:15 AM FILE: c:\xtdot\pw\on\line\txdot5\ibrahim.eisaad\d0326854\TCP_PHASE_2_STAGE_1_PLAN_SHEETS.dgn

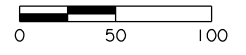
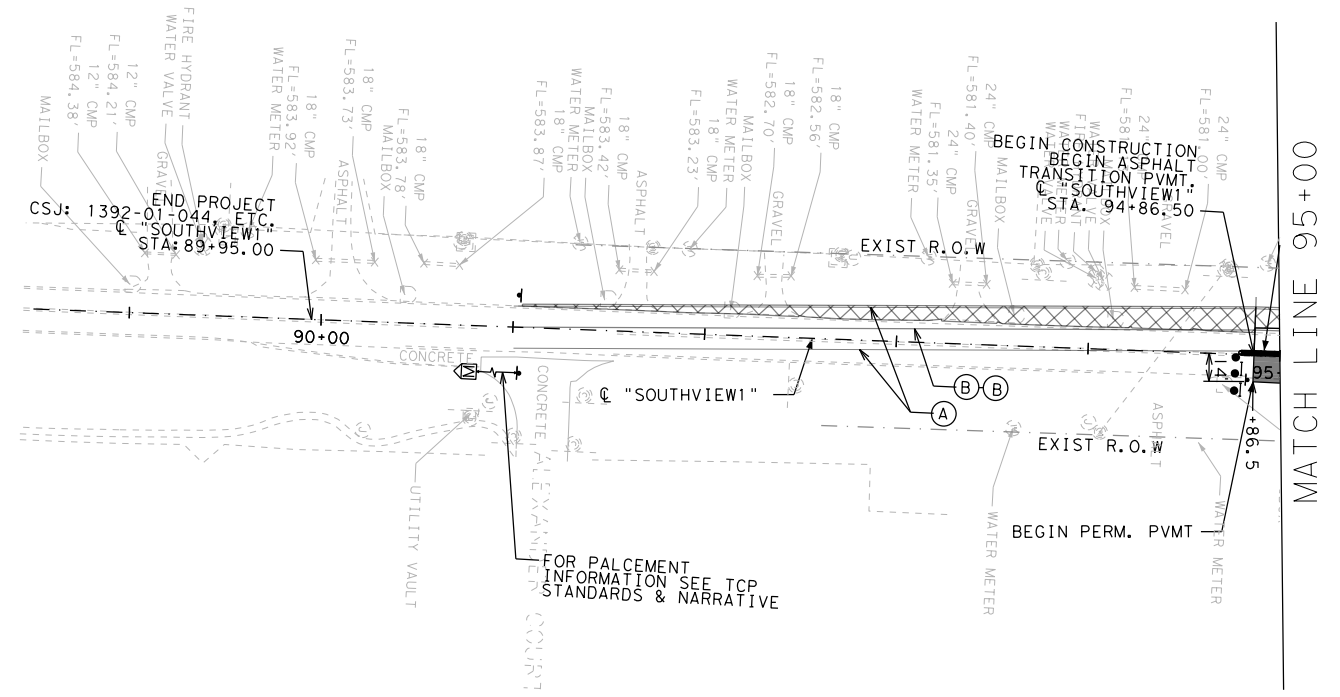
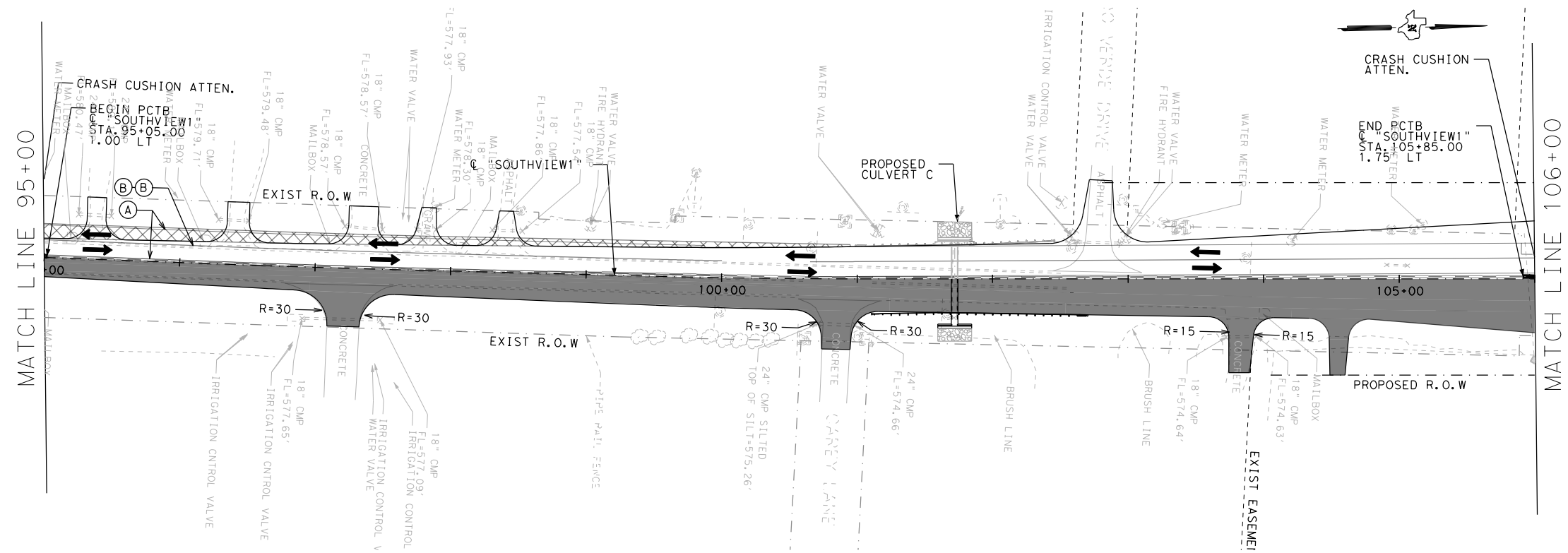

LEGEND

- EXISTING PAVEMENT
- PERMANENT CONSTRUCTION THIS PHASE
- PERMANENT CONSTRUCTION PREVIOUS PHASE
- TEMPORARY PAVEMENT CONSTRUCTED THIS PHASE
- TEMPORARY PAVEMENT CONSTRUCTED PREVIOUS PHASE
- PORTABLE CONCRETE TRAFFIC BARRIER (PCTB)
- CRASH CUSHION ATTENUATOR
- LOW PROFILE CONCRETE BARRIER (LPCB)
- SIGN POST
- TYPE III BARRICADE
- CHANNELIZATION DEVICES
- DIRECTIONAL TRAFFIC FLOW ARROWS
- WK ZN PAV MRK REMOV (W) 4" SLD
- WK ZN PAV MRK REMOV (Y) 4" SLD
- WK ZN PAV MRK NON-REMOV (W) 4" SLD
- WK ZN PAV MRK NON-REMOV (Y) 4" SLD
- WK ZN PAV MRK REMOV (W) 8" SLD
- WK ZN PAV MRK REMOV (W) 24" SLD
- MESSAGE BOARD
- TEMPORARY SHORING

NOTES:
 TRAFFIC UTILIZES EXISTING PAVEMENT MARKINGS EXCEPT WHERE SHOWN

CONTRACTOR IS RESPONSIBLE FOR MAINTAINING ADEQUATE DRAINAGE DURING CONSTRUCTION.

CONTRACTOR TO COORDINATE WITH PROPERTY OWNERS TO PROVIDE FIELD ACCESS WHEN REQUESTED.

REFER TO TCP MISC. DETAILS FOR DRIVEWAY & CROSS STREET CONSTRUCTION

REFER TO TEMPORARY SIGNAL LAYOUT FOR TEMPORARY TRAFFIC CONFIGURATIONS AT INTERSECTIONS

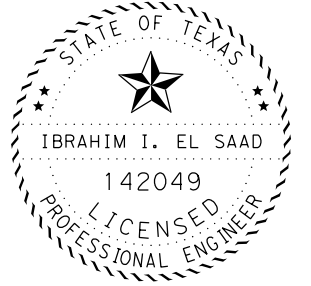

Abraham El Saad, P.E. 2-16-23
 Signature of Registrant & Date

© 2023

Texas Department of Transportation

FM 1378
AT FM 3286
TRAFFIC CONTROL PLAN
PHASE 2 STAGE 1

SCALE: 1"=100' SHEET 4 OF 5

DESIGN IIE	FED. RD. DIV. NO. 6	FEDERAL AID PROJECT NO. SEE TITLE SHEET		HIGHWAY NO. FM 1378, ETC.
GRAPHICS IIE	STATE TEXAS	DISTRICT DAL	COUNTY COLLIN	SHEET NO. 62
CHECK JI	CONTROL	SECTION	JOB	
CHECK JI	1392	01	044, ETC.	

DATE: 2/16/2023 TIME: 11:40:17 AM FILE: c:\txdot\pw\onl\ine\txdot5\ibrahim.e\saad\0326854\TCP_PHASE_2_STAGE_1_PLAN_SHEETS.dgn

SUMMARY OF TCP QUANTITIES

CSJ: 1392-01-044

ITEM #	DESCRIPTION	UNIT	SHEET TOTAL
512-6029	PORT CTB (MOVE)(F-SHAPE)(TY 1)	LF	1080
512-6053	PORT CTB (REMOVE)(F-SHAPE)(TY 1)	LF	1080
545-6003	CRASH CUSH ATTEN (MOVE & RESET)	EA	2
545-6005	CRASH CUSH ATTEN (REMOVE)	EA	2
662-6063	WK ZN PAV MRK REMOV (W) 4" (SLD)	LF	5412
662-6075	WK ZN PAV MRK REMOV (W)24"(SLD)	LF	22
662-6095	WK ZN PAV MRK REMOVE (Y) 4" (SLD)	LF	5759

SUMMARY OF TCP QUANTITIES

CSJ: 3476-02-013

ITEM #	DESCRIPTION	UNIT	SHEET TOTAL
662-6063	WK ZN PAV MRK REMOV (W) 4" (SLD)	LF	4652
662-6075	WK ZN PAV MRK REMOV (W)24"(SLD)	LF	11
662-6095	WK ZN PAV MRK REMOVE (Y) 4" (SLD)	LF	4651

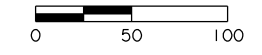

LEGEND

- EXISTING PAVEMENT
- PERMANENT CONSTRUCTION THIS PHASE
- PERMANENT CONSTRUCTION PREVIOUS PHASE
- TEMPORARY PAVEMENT CONSTRUCTED THIS PHASE
- TEMPORARY PAVEMENT CONSTRUCTED PREVIOUS PHASE
- PORTABLE CONCRETE TRAFFIC BARRIER (PCTB)
- CRASH CUSHION ATTENUATOR
- LOW PROFILE CONCRETE BARRIER (LPCB)
- SIGN POST
- TYPE III BARRICADE
- CHANNELIZATION DEVICES
- DIRECTIONAL TRAFFIC FLOW ARROWS
- WK ZN PAV MRK REMOV (W) 4" SLD
- WK ZN PAV MRK REMOV (Y) 4" SLD
- WK ZN PAV MRK NON-REMOV (W) 4" SLD
- WK ZN PAV MRK NON-REMOV (Y) 4" SLD
- WK ZN PAV MRK REMOV (W) 8" SLD
- WK ZN PAV MRK REMOV (W) 24" SLD
- MESSAGE BOARD
- TEMPORARY SHORING

NOTES:
 TRAFFIC UTILIZES EXISTING PAVEMENT MARKINGS EXCEPT WHERE SHOWN

CONTRACTOR IS RESPONSIBLE FOR MAINTAINING ADEQUATE DRAINAGE DURING CONSTRUCTION.

CONTRACTOR TO COORDINATE WITH PROPERTY OWNERS TO PROVIDE FIELD ACCESS WHEN REQUESTED.

REFER TO TCP MISC. DETAILS FOR DRIVEWAY & CROSS STREET CONSTRUCTION

REFER TO TEMPORARY SIGNAL LAYOUT FOR TEMPORARY TRAFFIC CONFIGURATIONS AT INTERSECTIONS

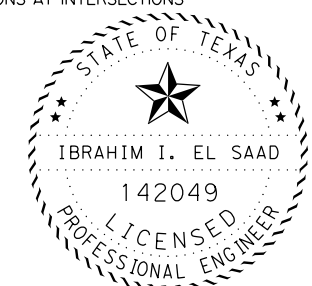

Abraham El Saad, P.E. 2-16-23
 Signature of Registrant & Date



FM 1378
AT FM 3286
SUMMARY OF QUANTITIES
PHASE 2 STAGE 1

SCALE: 1"=100' SHEET 5 OF 5

DESIGN IIE	FED. RD. DIV. NO. 6	FEDERAL AID PROJECT NO. SEE TITLE SHEET		HIGHWAY NO. FM 1378, ETC.
GRAPHICS IIE	STATE TEXAS	DISTRICT DAL	COUNTY COLLIN	SHEET NO. 63
CHECK JI	CONTROL	SECTION	JOB	
CHECK JI	1392	01	044, ETC.	

DATE: 2/16/2023 TIME: 10:52:17 AM FILE: c:\txdot\pw\onl\ine\txdot5\ibrahim.elsaad\d0326854\TCP Typical Sections Sheets P2S2 .dgn

- LEGEND**
- PERMANENT CONSTRUCTION THIS PHASE
 - PERMANENT CONSTRUCTION PREVIOUS PHASE
 - ▬ DETOUR PAVEMENT
 - Ⓐ - 2" SUPERPAVE MIXTURES (SP-C) (PG64-22)
 - Ⓑ - 4" SUPERPAVE MIXTURES (SP-B) (PG64-22)
 - Ⓒ - 8" LTS WITH 5% LIME (EXIST)

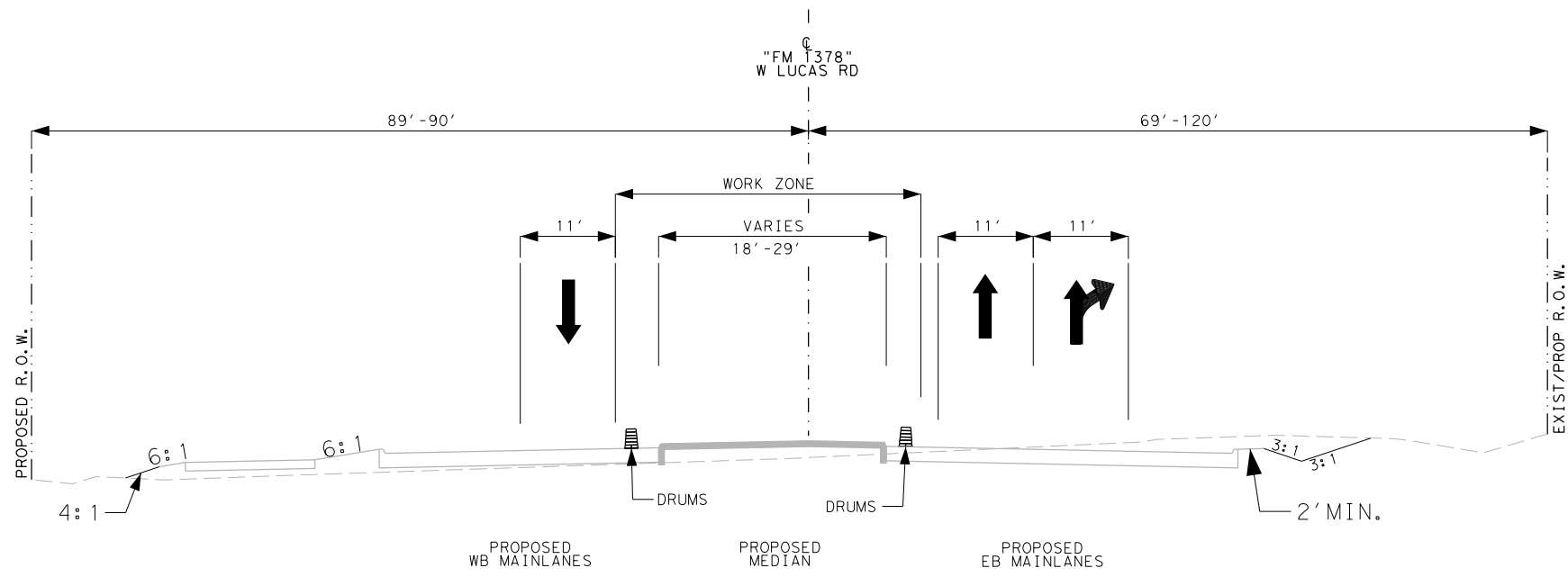

TCP PHASE 2 STAGE 2 FM 1378 TYPICAL SECTION
 @ "FM 1378" W LUCAS RD STA. 16+16 TO STA. 21+50

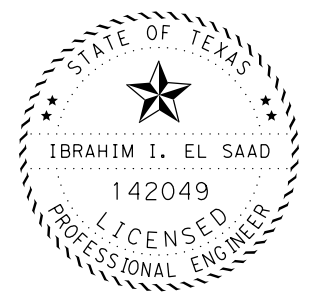

Abraham I. El Saad, P.E. 2-16-23
 Signature of Registrant & Date

© 2023

Texas Department of Transportation

FM 1378
AT FM 3286
TRAFFIC CONTROL PLAN
PHASE 2 STAGE 2
TYPICAL SECTION

SHEET 1 OF 1

DESIGN I/E	FED. RD. DIV. NO.	FEDERAL AID PROJECT NO.		HIGHWAY NO.
GRAPHICS I/E	6	SEE TITLE SHEET		FM 1378, ETC.
CHECK J/I	STATE	DISTRICT	COUNTY	SHEET NO.
CHECK J/I	TEXAS	DAL	COLLIN	64
CHECK J/I	CONTROL	SECTION	JOB	
	1392	01	044, ETC.	

DATE: 2/16/2023 TIME: 10:52:25 AM FILE: c:\txdot\pw\onl\ine\txdot5\ibrahim.e\saad\0326854\TCP PHASE 2 STAGE 2 PLAN SHEETS.dgn

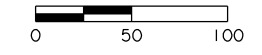
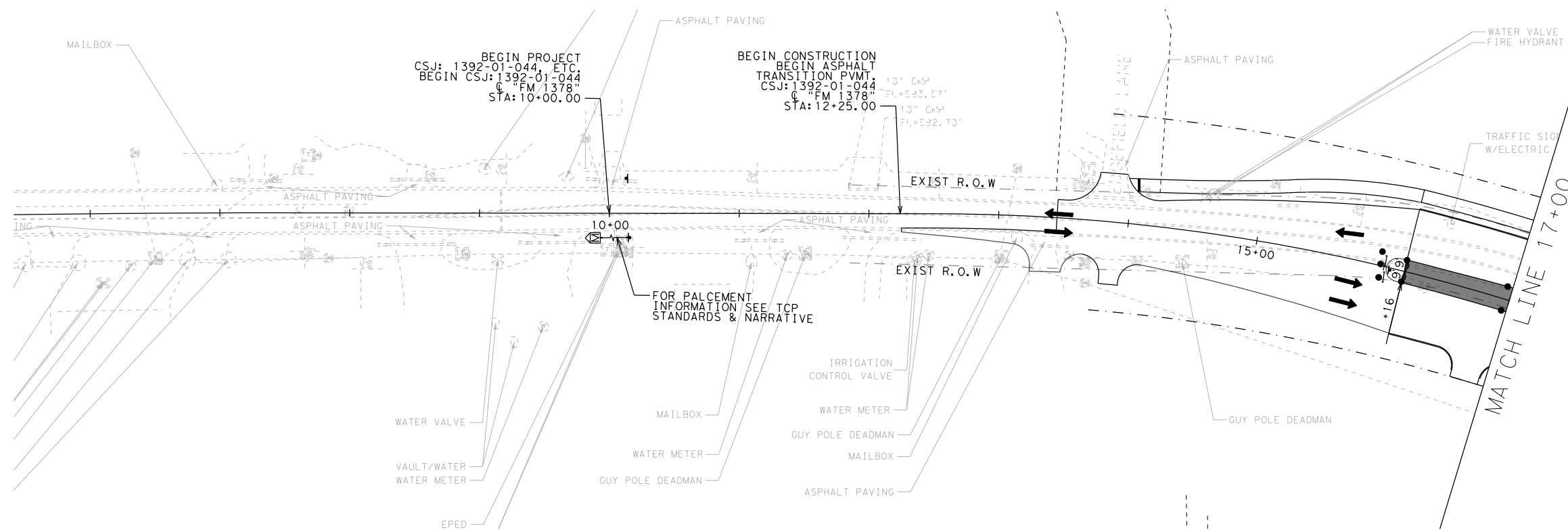

- LEGEND**
- EXISTING PAVEMENT
 - PERMANENT CONSTRUCTION THIS PHASE
 - PERMANENT CONSTRUCTION PREVIOUS PHASE
 - TEMPORARY PAVEMENT CONSTRUCTED THIS PHASE
 - TEMPORARY PAVEMENT CONSTRUCTED PREVIOUS PHASE
 - PORTABLE CONCRETE TRAFFIC BARRIER (PCTB)
 - CRASH CUSHION ATTENUATOR
 - LOW PROFILE CONCRETE BARRIER (LPCB)
 - SIGN POST
 - TYPE III BARRICADE
 - CHANNELIZATION DEVICES
 - DIRECTIONAL TRAFFIC FLOW ARROWS
 - WK ZN PAV MRK REMOV (W) 4" SLD
 - WK ZN PAV MRK REMOV (Y) 4" SLD
 - WK ZN PAV MRK NON-REMOV (W) 4" SLD
 - WK ZN PAV MRK NON-REMOV (Y) 4" SLD
 - WK ZN PAV MRK REMOV (W) 8" SLD
 - WK ZN PAV MRK REMOV (W) 24" SLD
 - MESSAGE BOARD
 - TEMPORARY SHORING

NOTES:

TRAFFIC UTILIZES EXISTING PAVEMENT MARKINGS EXCEPT WHERE SHOWN

CONTRACTOR IS RESPONSIBLE FOR MAINTAINING ADEQUATE DRAINAGE DURING CONSTRUCTION.

CONTRACTOR TO COORDINATE WITH PROPERTY OWNERS TO PROVIDE FIELD ACCESS WHEN REQUESTED.

REFER TO TCP MISC. DETAILS FOR DRIVEWAY & CROSS STREET CONSTRUCTION

REFER TO TEMPORARY SIGNAL LAYOUT FOR TEMPORARY TRAFFIC CONFIGURATIONS AT INTERSECTIONS

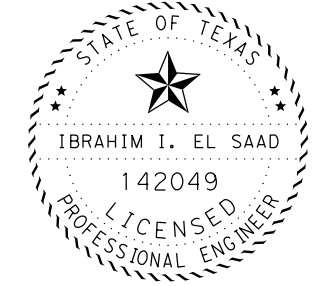

Abraham El Saad, P.E. 2-16-23
Signature of Registrant & Date

© 2023

FM 1378

AT FM 3286

TRAFFIC CONTROL PLAN

PHASE 2 STAGE 2

SCALE: 1"=100'

SHEET 1 OF 5

DESIGN IIE	FED. RD. DIV. NO. 6	FEDERAL AID PROJECT NO. SEE TITLE SHEET		HIGHWAY NO. FM 1378, ETC.
GRAPHICS IIE	STATE TEXAS	DISTRICT DAL	COUNTY COLLIN	SHEET NO. 65
CHECK JI	CONTROL	SECTION	JOB	
CHECK JI	1392	01	044, ETC.	

DATE: 2/16/2023 TIME: 10:52:28 AM FILE: c:\txdot\pw\onl\ine\txdot5\ibrahim.e\saad\0326854\TCP_PHASE_2_STAGE_2_PLAN_SHEETS.dgn

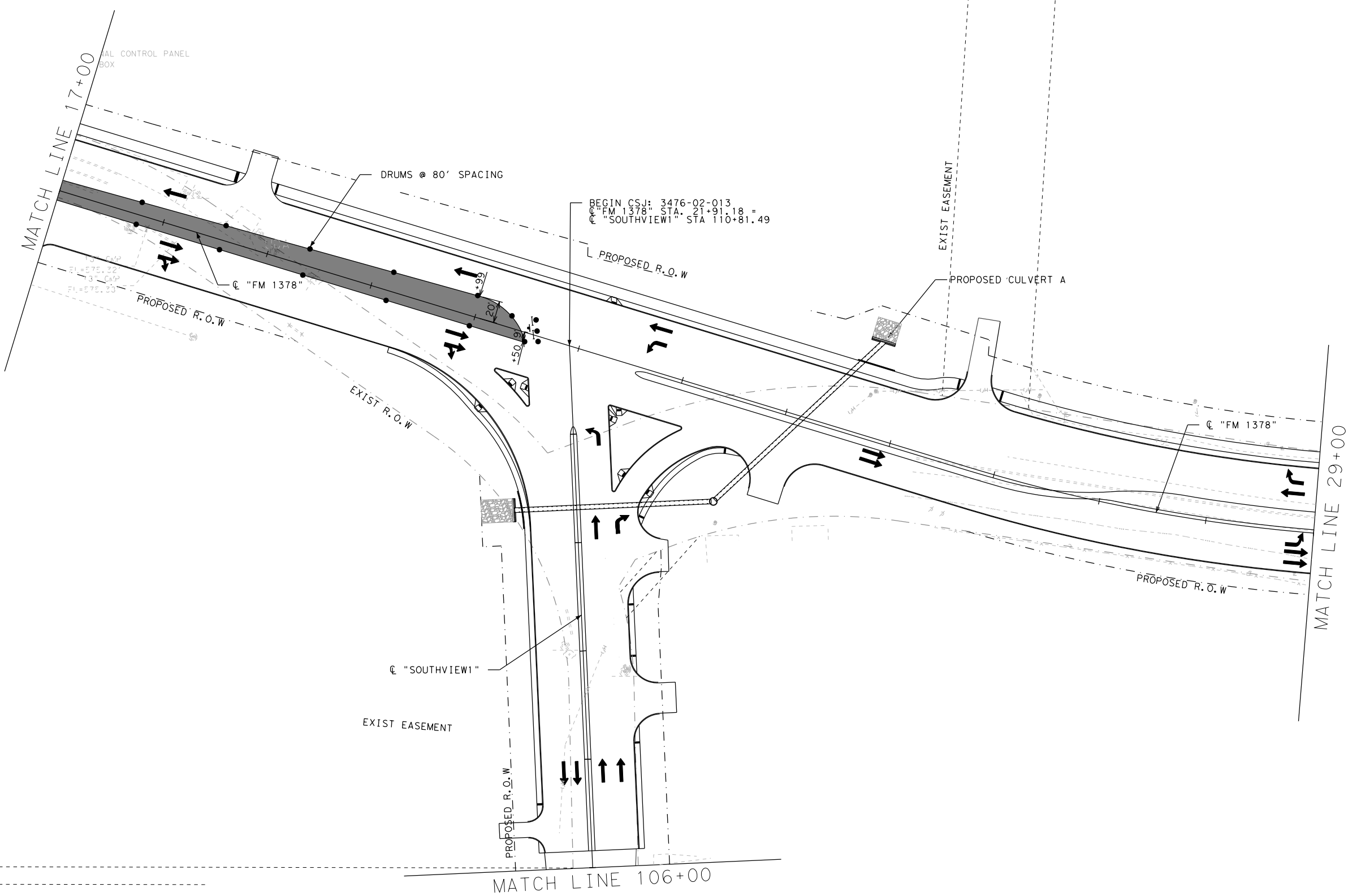

LEGEND

0 50 100

- EXISTING PAVEMENT
- PERMANENT CONSTRUCTION THIS PHASE
- PERMANENT CONSTRUCTION PREVIOUS PHASE
- TEMPORARY PAVEMENT CONSTRUCTED THIS PHASE
- TEMPORARY PAVEMENT CONSTRUCTED PREVIOUS PHASE
- PORTABLE CONCRETE TRAFFIC BARRIER (PCTB)
- CRASH CUSHION ATTENUATOR
- LOW PROFILE CONCRETE BARRIER (LPCB)
- SIGN POST
- TYPE III BARRICADE
- CHANNELIZATION DEVICES
- DIRECTIONAL TRAFFIC FLOW ARROWS
- WK ZN PAV MRK REMOV (W) 4" SLD
- WK ZN PAV MRK REMOV (Y) 4" SLD
- WK ZN PAV MRK NON-REMOV (W) 4" SLD
- WK ZN PAV MRK NON-REMOV (Y) 4" SLD
- WK ZN PAV MRK REMOV (W) 8" SLD
- WK ZN PAV MRK REMOV (W) 24" SLD
- MESSAGE BOARD
- TEMPORARY SHORING

NOTES:

TRAFFIC UTILIZES EXISTING PAVEMENT MARKINGS EXCEPT WHERE SHOWN

CONTRACTOR IS RESPONSIBLE FOR MAINTAINING ADEQUATE DRAINAGE DURING CONSTRUCTION.

CONTRACTOR TO COORDINATE WITH PROPERTY OWNERS TO PROVIDE FIELD ACCESS WHEN REQUESTED.

REFER TO TCP MISC. DETAILS FOR DRIVEWAY & CROSS STREET CONSTRUCTION

REFER TO TEMPORARY SIGNAL LAYOUT FOR TEMPORARY TRAFFIC CONFIGURATIONS AT INTERSECTIONS

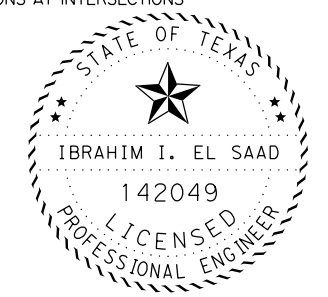

Abraham El Saad, P.E. 2-16-23
Signature of Registrant & Date

© 2023

Texas Department of Transportation

FM 1378
AT FM 3286
TRAFFIC CONTROL PLAN
PHASE 2 STAGE 2

SCALE: 1"=100' SHEET 2 OF 5

DESIGN	FED. RD. DIV. NO.	FEDERAL AID PROJECT NO.		HIGHWAY NO.
IIE	6	SEE TITLE SHEET		FM 1378, ETC.
GRAPHICS	IIE	STATE	DISTRICT	COUNTY
CHECK	J1	TEXAS	DAL	COLLIN
CHECK	J1	CONTROL	SECTION	JOB
J1	1392	01	044, ETC.	

66

DATE: 2/16/2023 TIME: 10:52:31 AM FILE: c:\txdot\pw\onl\ine\txdot5\ibrahim.e\saad\0326854\TCP_PHASE_2_STAGE_2_PLAN_SHEETS.dgn

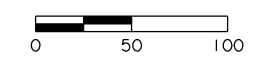
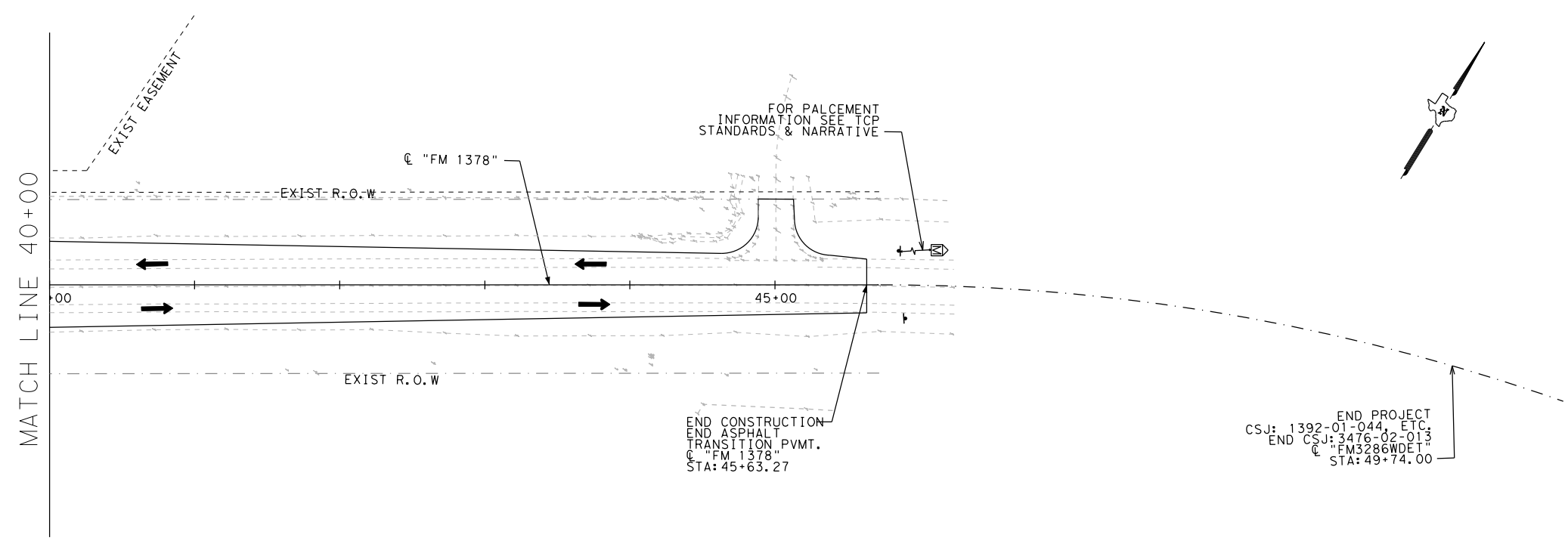
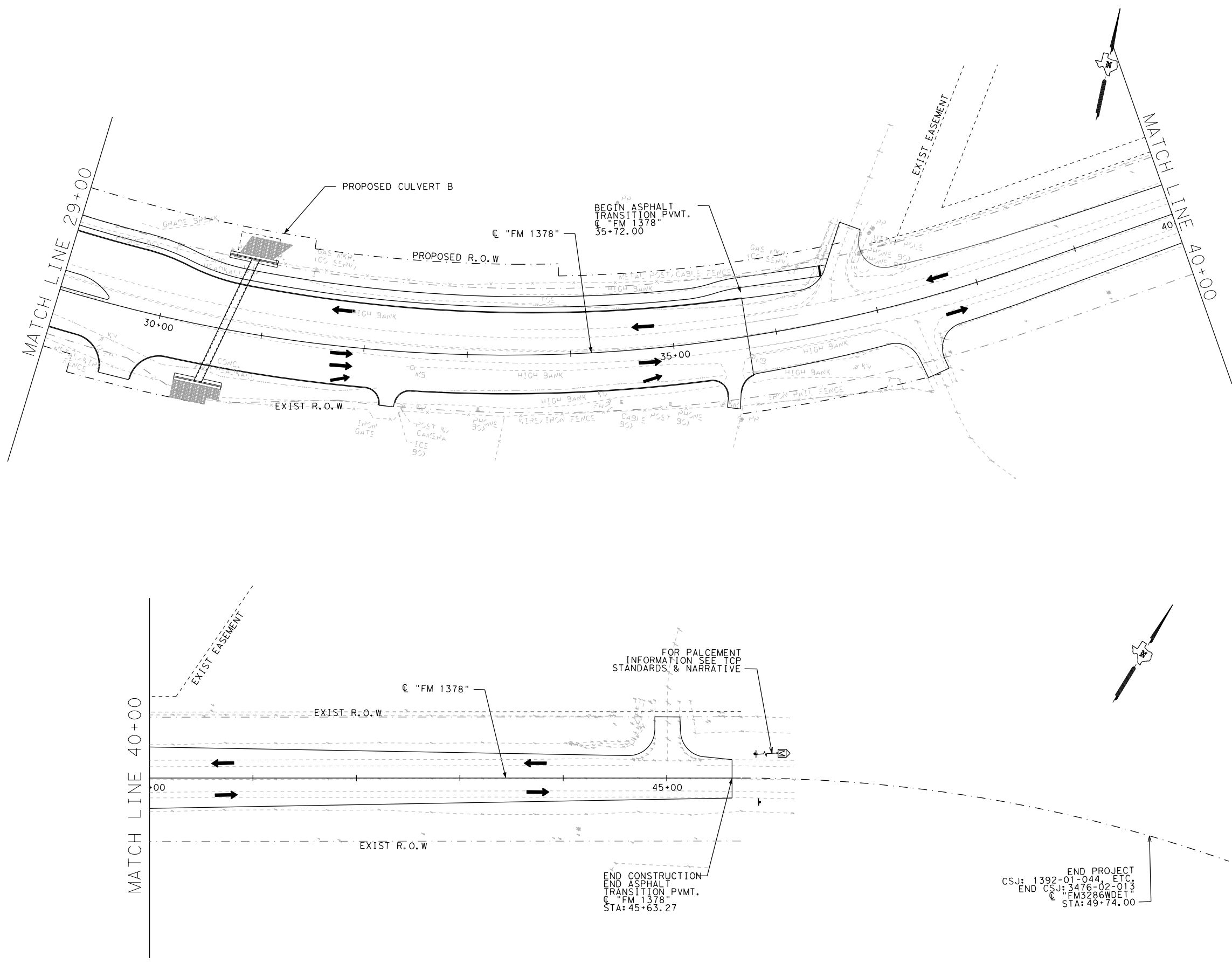

- LEGEND**
- EXISTING PAVEMENT
 - PERMANENT CONSTRUCTION THIS PHASE
 - PERMANENT CONSTRUCTION PREVIOUS PHASE
 - TEMPORARY PAVEMENT CONSTRUCTED THIS PHASE
 - TEMPORARY PAVEMENT CONSTRUCTED PREVIOUS PHASE
 - PORTABLE CONCRETE TRAFFIC BARRIER (PCTB)
 - CRASH CUSHION ATTENUATOR
 - LOW PROFILE CONCRETE BARRIER (LPCB)
 - SIGN POST
 - TYPE III BARRICADE
 - CHANNELIZATION DEVICES
 - DIRECTIONAL TRAFFIC FLOW ARROWS
 - WK ZN PAV MRK REMOV (W) 4" SLD
 - WK ZN PAV MRK REMOV (Y) 4" SLD
 - WK ZN PAV MRK NON-REMOV (W) 4" SLD
 - WK ZN PAV MRK NON-REMOV (Y) 4" SLD
 - WK ZN PAV MRK REMOV (W) 8" SLD
 - WK ZN PAV MRK REMOV (W) 24" SLD
 - MESSAGE BOARD
 - TEMPORARY SHORING

NOTES:
 TRAFFIC UTILIZES EXISTING PAVEMENT MARKINGS EXCEPT WHERE SHOWN

CONTRACTOR IS RESPONSIBLE FOR MAINTAINING ADEQUATE DRAINAGE DURING CONSTRUCTION.

CONTRACTOR TO COORDINATE WITH PROPERTY OWNERS TO PROVIDE FIELD ACCESS WHEN REQUESTED.

REFER TO TCP MISC. DETAILS FOR DRIVEWAY & CROSS STREET CONSTRUCTION

REFER TO TEMPORARY SIGNAL LAYOUT FOR TEMPORARY TRAFFIC CONFIGURATIONS AT INTERSECTIONS

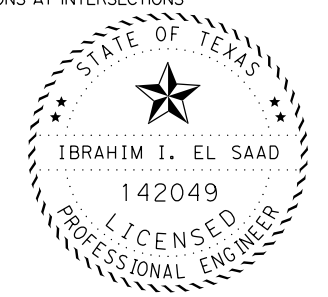

Abraham El Saad, P.E. 2-16-23
 Signature of Registrant & Date

© 2023

Texas Department of Transportation

FM 1378

AT FM 3286

TRAFFIC CONTROL PLAN

PHASE 2 STAGE 2

SCALE: 1"=100' SHEET 3 OF 5

DESIGN IIE	FED. RD. DIV. NO. 6	FEDERAL AID PROJECT NO. SEE TITLE SHEET		HIGHWAY NO. FM 1378, ETC.
GRAPHICS IIE	STATE TEXAS	DISTRICT DAL	COUNTY COLLIN	SHEET NO. 67
CHECK JI	CONTROL	SECTION	JOB	
CHECK JI	1392	01	044, ETC.	

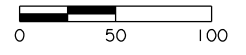
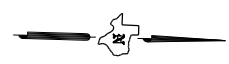
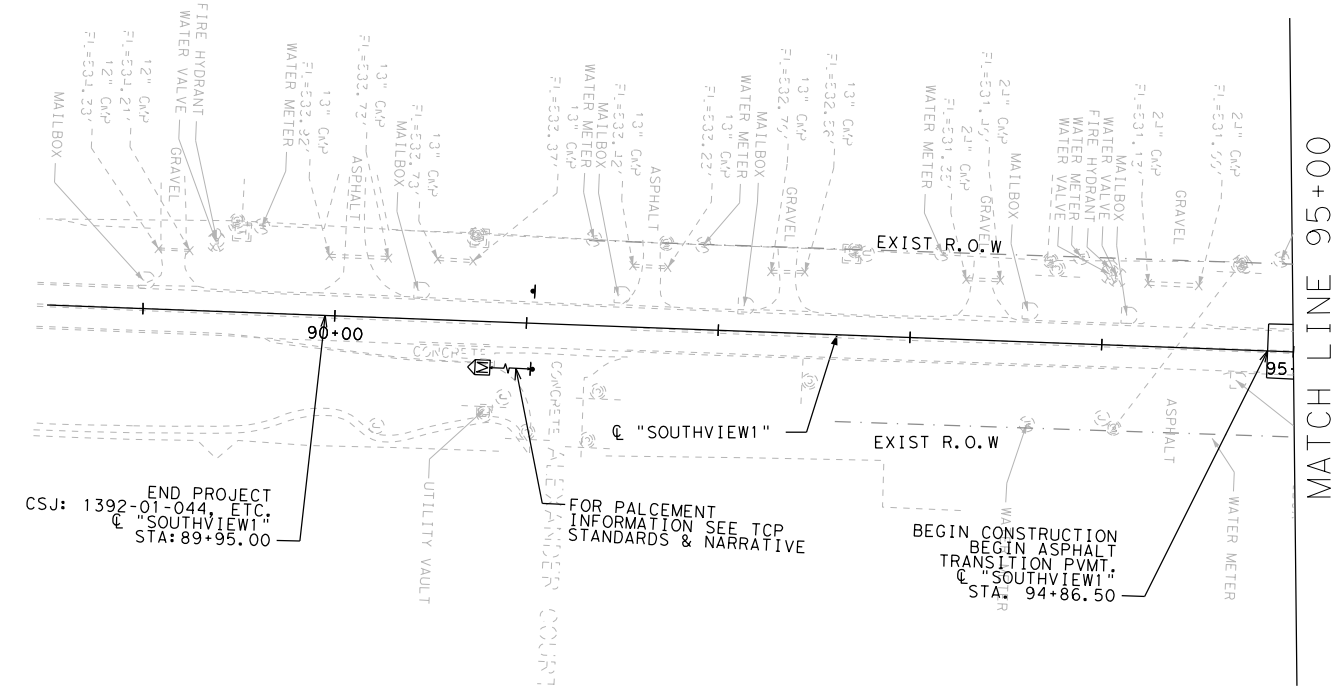
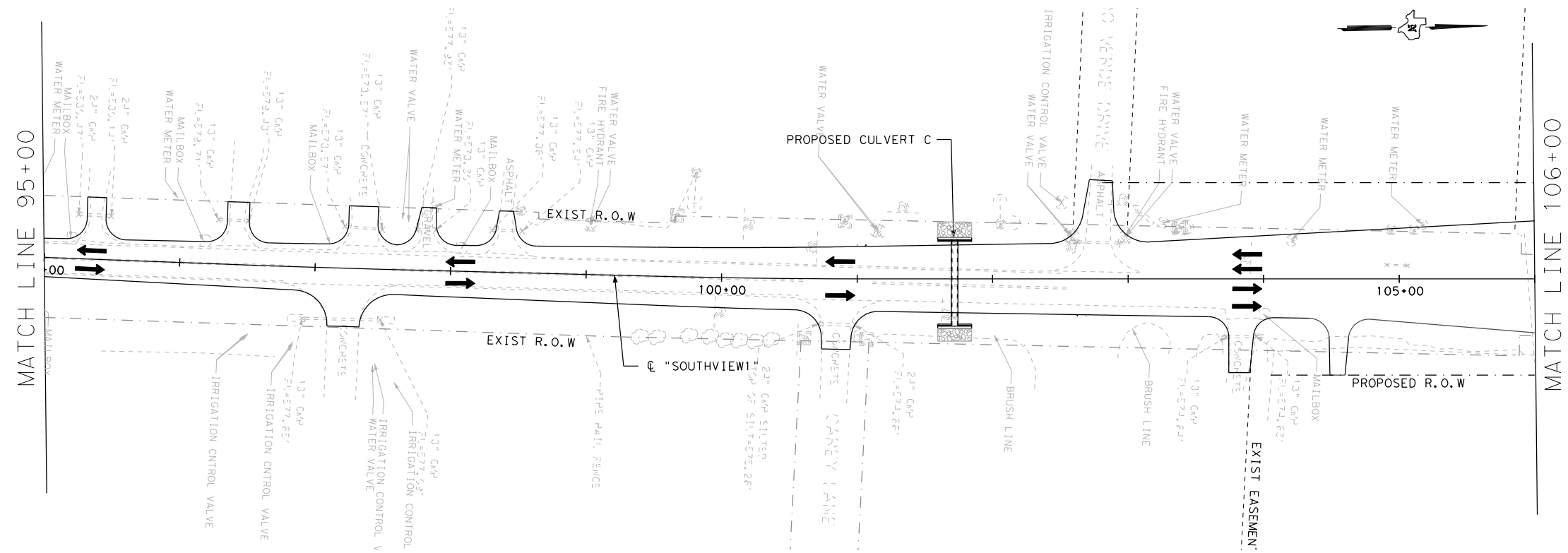

- LEGEND**
- EXISTING PAVEMENT
 - PERMANENT CONSTRUCTION THIS PHASE
 - PERMANENT CONSTRUCTION PREVIOUS PHASE
 - TEMPORARY PAVEMENT CONSTRUCTED THIS PHASE
 - TEMPORARY PAVEMENT CONSTRUCTED PREVIOUS PHASE
 - PORTABLE CONCRETE TRAFFIC BARRIER (PCTB)
 - CRASH CUSHION ATTENUATOR
 - LOW PROFILE CONCRETE BARRIER (LPCB)
 - SIGN POST
 - TYPE III BARRICADE
 - CHANNELIZATION DEVICES
 - DIRECTIONAL TRAFFIC FLOW ARROWS
 - WK ZN PAV MRK REMOV (W) 4" SLD
 - WK ZN PAV MRK REMOV (Y) 4" SLD
 - WK ZN PAV MRK NON-REMOV (W) 4" SLD
 - WK ZN PAV MRK NON-REMOV (Y) 4" SLD
 - WK ZN PAV MRK REMOV (W) 8" SLD
 - WK ZN PAV MRK REMOV (W) 24" SLD
 - MESSAGE BOARD
 - TEMPORARY SHORING

NOTES:

TRAFFIC UTILIZES EXISTING PAVEMENT MARKINGS EXCEPT WHERE SHOWN

CONTRACTOR IS RESPONSIBLE FOR MAINTAINING ADEQUATE DRAINAGE DURING CONSTRUCTION.

CONTRACTOR TO COORDINATE WITH PROPERTY OWNERS TO PROVIDE FIELD ACCESS WHEN REQUESTED.

REFER TO TCP MISC. DETAILS FOR DRIVEWAY & CROSS STREET CONSTRUCTION

REFER TO TEMPORARY SIGNAL LAYOUT FOR TEMPORARY TRAFFIC CONFIGURATIONS AT INTERSECTIONS

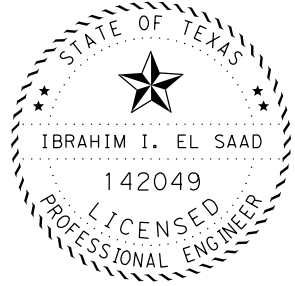

Abraham El Saad, P.E. 2-16-23
Signature of Registrant & Date

© 2023

Texas Department of Transportation

FM 1378
AT FM 3286
TRAFFIC CONTROL PLAN
PHASE 2 STAGE 2

SCALE: 1"=100' SHEET 4 OF 5

DESIGN IIE	FED. RD. DIV. NO. 6	FEDERAL AID PROJECT NO. SEE TITLE SHEET		HIGHWAY NO. FM 1378, ETC.
GRAPHICS IIE	STATE TEXAS	DISTRICT DAL	COUNTY COLLIN	SHEET NO. 68
CHECK JI	CONTROL	SECTION	JOB	
CHECK JI	1392	01	044, ETC.	

DATE: 2/16/2023 TIME: 10:52:35 AM FILE: c:\txdot\pw\onl\ine\txdot5\ibrahim.e\saad\0326854\TCP_PHASE_2_STAGE_2_PLAN_SHEETS.dgn

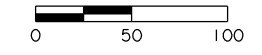

SUMMARY OF TCP QUANTITIES

CSJ: 1392-01-044

ITEM #	DESCRIPTION	UNIT	SHEET TOTAL
529-6011	CONC CURB (DOWEL)	LF	378

- LEGEND
- EXISTING PAVEMENT
 - PERMANENT CONSTRUCTION THIS PHASE
 - PERMANENT CONSTRUCTION PREVIOUS PHASE
 - TEMPORARY PAVEMENT CONSTRUCTED THIS PHASE
 - TEMPORARY PAVEMENT CONSTRUCTED PREVIOUS PHASE
 - PORTABLE CONCRETE TRAFFIC BARRIER (PCTB)
 - CRASH CUSHION ATTENUATOR
 - LOW PROFILE CONCRETE BARRIER (LPCB)
 - SIGN POST
 - TYPE III BARRICADE
 - CHANNELIZATION DEVICES
 - DIRECTIONAL TRAFFIC FLOW ARROWS
 - WK ZN PAV MRK REMOV (W) 4" SLD
 - WK ZN PAV MRK REMOV (Y) 4" SLD
 - WK ZN PAV MRK NON-REMOV (W) 4" SLD
 - WK ZN PAV MRK NON-REMOV (Y) 4" SLD
 - WK ZN PAV MRK REMOV (W) 8" SLD
 - WK ZN PAV MRK REMOV (W) 24" SLD
 - MESSAGE BOARD
 - TEMPORARY SHORING

NOTES:
 TRAFFIC UTILIZES EXISTING PAVEMENT MARKINGS EXCEPT WHERE SHOWN

CONTRACTOR IS RESPONSIBLE FOR MAINTAINING ADEQUATE DRAINAGE DURING CONSTRUCTION.

CONTRACTOR TO COORDINATE WITH PROPERTY OWNERS TO PROVIDE FIELD ACCESS WHEN REQUESTED.

REFER TO TCP MISC. DETAILS FOR DRIVEWAY & CROSS STREET CONSTRUCTION

REFER TO TEMPORARY SIGNAL LAYOUT FOR TEMPORARY TRAFFIC CONFIGURATIONS AT INTERSECTIONS

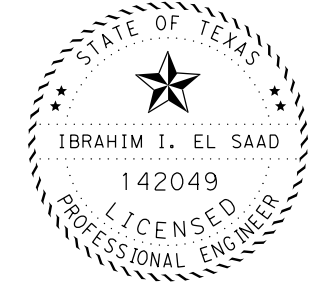

Abraham El Saad, P.E. 2-16-23
 Signature of Registrant & Date

© 2023

FM 1378
AT FM 3286
SUMMARY OF QUANTITIES
PHASE 2 STAGE 2

SCALE: 1"=100' SHEET 5 OF 5

DESIGN IIE	FED. RD. DIV. NO. 6	FEDERAL AID PROJECT NO. SEE TITLE SHEET		HIGHWAY NO. FM 1378, ETC.
GRAPHICS IIE	STATE TEXAS	DISTRICT DAL	COUNTY COLLIN	SHEET NO. 69
CHECK JI	CONTROL	SECTION	JOB	
CHECK JI	1392	01	044, ETC.	

DISCLAIMER: The use of this standard is governed by the "Texas Engineering Practice Act". No warranty of any kind is made by TxDOT for any purpose whatsoever. TxDOT assumes no responsibility for the conversion of this standard to other formats or for incorrect results or damages resulting from its use.

LOCATION NUMBER	TCP PHASE	LOCATION	STATION/OFFSET	TEST LEVEL	DIRECTION OF TRAFFIC (UNI/BI)	FOUNDATION PAD		BACKUP SUPPORT			AVAILABLE SITE LENGTH	CRASH CUSHION																
						PROPOSED MATERIAL	PROPOSED THICKNESS	DESCRIPTION	WIDTH	HEIGHT		INSTALL	REMOVE	MOVE / RESET		L	L	R	R	S	S							
														MOVE/RESET	FROM LOC. #	N	W	N	W	N	W							
A- SHEET 3 OF 4	PHASE 1 STAGE 1-A	FM 3286	29+55.00 / 19.45 LT	TL-3	UNI	SEE STD	SEE STD	PRECAST TRAFFIC BARRIER	22"	33"	35'	1									X							
B- SHEET 3 OF 4	PHASE 1 STAGE 1-A	FM 3286	31+95.00 / 15.85 LT	TL-3	UNI	SEE STD	SEE STD	PRECAST TRAFFIC BARRIER	22"	33"	35'	1										X						
C- SHEET 3 OF 4	PHASE 1 STAGE 1-A	FM 3286	37+50.00 / 4.50 LT	TL-3	UNI	SEE STD	SEE STD	PRECAST TRAFFIC BARRIER	22"	33"	35'	1											X					
D- SHEET 3 OF 4	PHASE 1 STAGE 1-A	FM 3286	44+10.00 / 4.50 LT	TL-3	UNI	SEE STD	SEE STD	PRECAST TRAFFIC BARRIER	22"	33"	35'	1												X				
E- SHEET 3 OF 4	PHASE 1 STAGE 2	FM 3286	24+33.00 / 23.50 LT	TL-3	UNI	SEE STD	SEE STD	PRECAST TRAFFIC BARRIER	22"	33"	35'		1	1	A									X				
F- SHEET 3 OF 4	PHASE 1 STAGE 2	FM 3286	35+73.00 / 12.25 LT	TL-3	UNI	SEE STD	SEE STD	PRECAST TRAFFIC BARRIER	22"	33"	35'		1	1	B										X			
G- SHEET 4 OF 4	PHASE 1 STAGE 2	FM 3286	95+05.00 / 1.00 RT	TL-3	UNI	SEE STD	SEE STD	PRECAST TRAFFIC BARRIER	22"	33"	35'			1	C											X		
H- SHEET 4 OF 4	PHASE 1 STAGE 2	FM 3286	105+85.00 / 1.25 RT	TL-3	UNI	SEE STD	SEE STD	PRECAST TRAFFIC BARRIER	22"	33"	35'			1	D												X	
I- SHEET 4 OF 4	PHASE 1 STAGE 2	FM 3286	101+47.00 / 26.50 RT	TL-3	UNI	SEE STD	SEE STD	PRECAST TRAFFIC BARRIER	22"	33"	35'	1	1														X	
J- SHEET 4 OF 4	PHASE 1 STAGE 2	FM 3286	102+07.00 / 27.85 LT	TL-3	UNI	SEE STD	SEE STD	PRECAST TRAFFIC BARRIER	22"	33"	35'	1	1														X	
K- SHEET 4 OF 4	PHASE 2 STAGE 1	FM 3286	95+05.00 / 1.00 LT	TL-3	UNI	SEE STD	SEE STD	PRECAST TRAFFIC BARRIER	22"	33"	35'			1	I												X	
L- SHEET 4 OF 4	PHASE 2 STAGE 1	FM 3286	105+85.00 / 1.75 LT	TL-3	UNI	SEE STD	SEE STD	PRECAST TRAFFIC BARRIER	22"	33"	35'			1	J												X	
											TOTALS	6	6	8														

LEGEND:
 L=LOW MAINTENANCE
 R=REUSABLE
 S=SACRIFICIAL
 N=NARROW
 W=WIDE

FOR DEFINITIONS SEE THE "CRASH CUSHION CATEGORIZATION CHART.PDF" AT THE DESIGN DIVISION (ROADWAY STANDARDS) WEBSITE. USE QUICK LINKS TO ACCESS ATTENUATORS / CRASH CUSHIONS SECTION.
<http://www.dot.state.tx.us/insdot/orgchart/cmd/cserve/standard/rdwylse.htm>

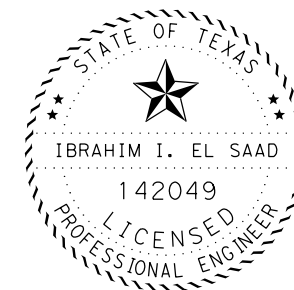

Abraham I. Saad, P.E. 2-16-23
 Signature of Registrant & Date

CRASH CUSHION SUMMARY SHEET

FILE: CCSS.dgn	DN: TxDOT	CK:	CK:
© TxDOT	CONT	SECT	JOB
REVISIONS	1392	01	044, ETC.
	DIST	COUNTY	
	DAL	COLLIN	
	FEDERAL AID PROJECT		
	SEE TITLE SHEET		
	HIGHWAY		
	FM 1378, ETC.		
	SHEET NO.		
	70		

DATE: 2/16/2023 TIME: 11:14:48 AM FILE: c:\txdot\pw\onl\ine\txdot5\ibrahim.e\saad\0326854\TCP\Miscellaneous*Detail.s.dgn

LEGEND

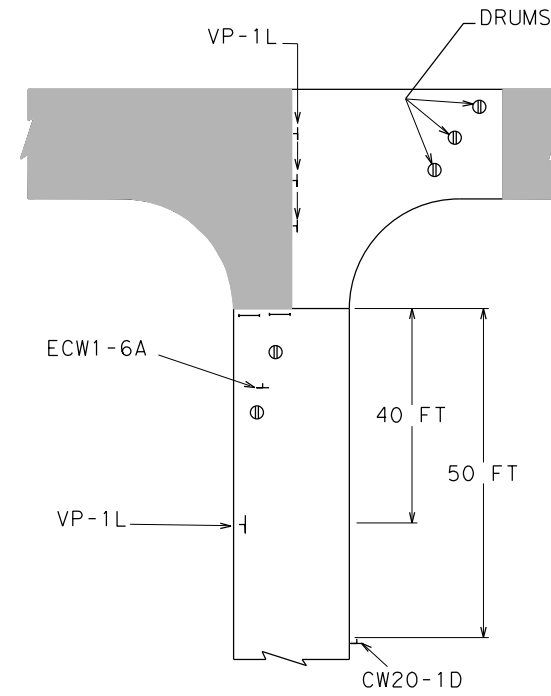
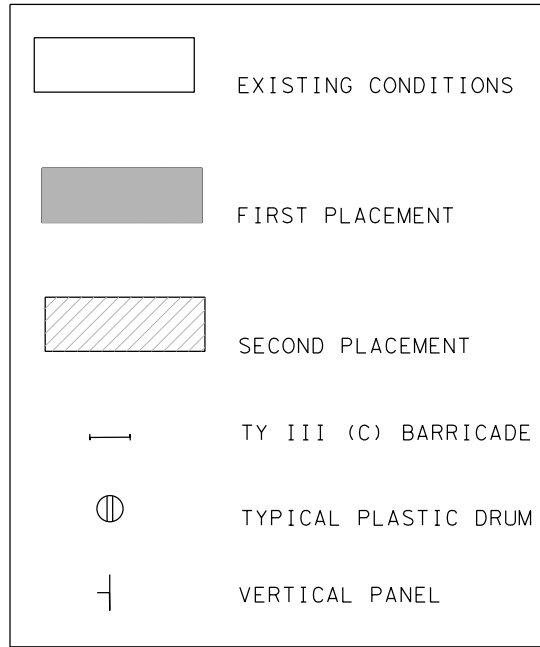

STAGE A

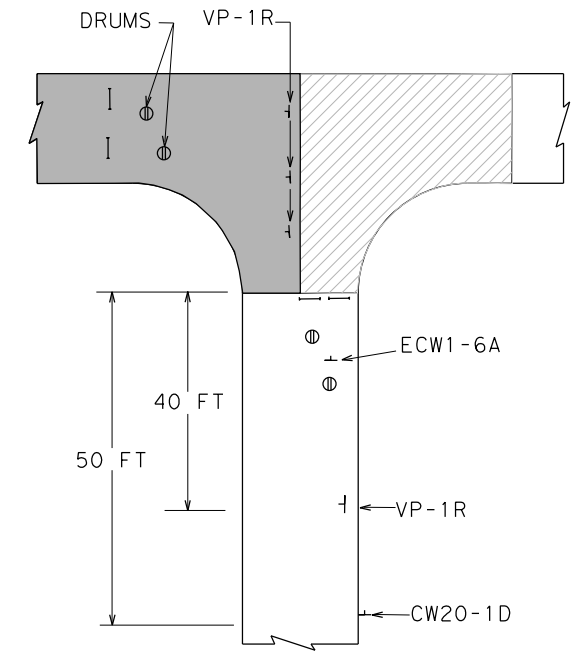

STAGE B

TYPICAL CONSTRUCTION & WARNING SIGNS AT DRIVEWAYS AND CROSS STREETS

NOTES:

1. THE CONTRACTOR SHALL HAVE THE OPTION OF REVERSING STAGES OUTLINED TO EXPEDITE CONSTRUCTION OF PROPOSED PAVEMENT AS NEEDED FOR DRIVEWAYS AND NON-SIGNALIZED INTERSECTIONS. SUBMIT ANY PROPOSED CHANGES FOR APPROVAL.
2. CONTRACTOR SHALL CONTACT THE ENGINEER AND PROPERTY OWNERS BEFORE DISTURBING EXISTING DRIVEWAYS. IF PROPERTY HAS MORE THAN ONE DRIVEWAY, CONTRACTOR SHALL NOT DISTURB MORE THAN ONE DRIVEWAY AT A TIME.
3. FOR PROPERTIES WITH ONLY ONE DRIVEWAY, CONTRACTOR SHALL PHASE CONSTRUCTION. PROVIDE TEMPORARY ACCESS AS DIRECTED BY THE ENGINEER. COST IS NOT PAID FOR DIRECTLY BUT IS CONSIDERED SUBSIDIARY TO ITEM 502 " BARRICADES, SIGNS, AND TRAFFIC HANDLING".
4. DRIVEWAYS SHALL BE OPENED TO TRAFFIC AS SOON AS COMPLETED WITH VERTICAL PANNELS PLACED ALONG THE OUTSIDE TO GUIDE TRAFFIC TO AND FROM THE EXISTING PAVEMENT.

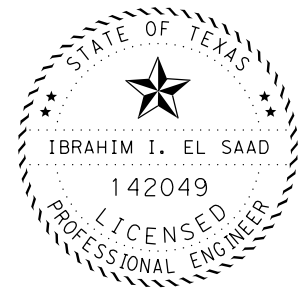

Ibrahim I. El Saad, P.E. 2-16-23
 Signature of Registrant & Date

				© 2023
FM 1378 AT FM 3286 TCP MISCELLANEOUS DETAILS				
SHEET 1 OF 1				
DESIGN	FED. RD. DIV. NO.	FEDERAL AID PROJECT NO.		HIGHWAY NO.
J1	6	SEE TITLE SHEET		FM 1378, ETC.
GRAPHICS	STATE	DISTRICT	COUNTY	SHEET NO.
J1	TEXAS	DAL	COLLIN	71
CHECK IIE	CONTROL	SECTION	JOB	
CHECK	1392	01	044, ETC.	

LEGEND

- PERMANENT CONSTRUCTION THIS PHASE
- PERMANENT CONSTRUCTION PREVIOUS PHASE

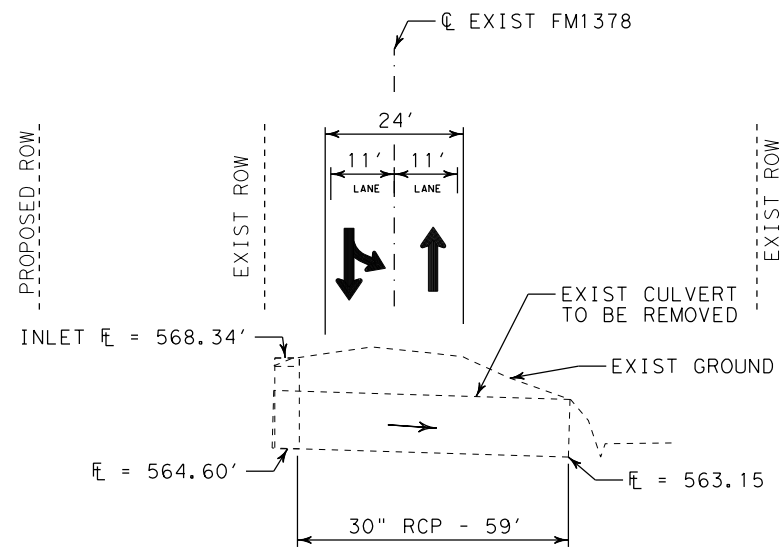

TYPICAL SECTION - EXISTING CULVERT

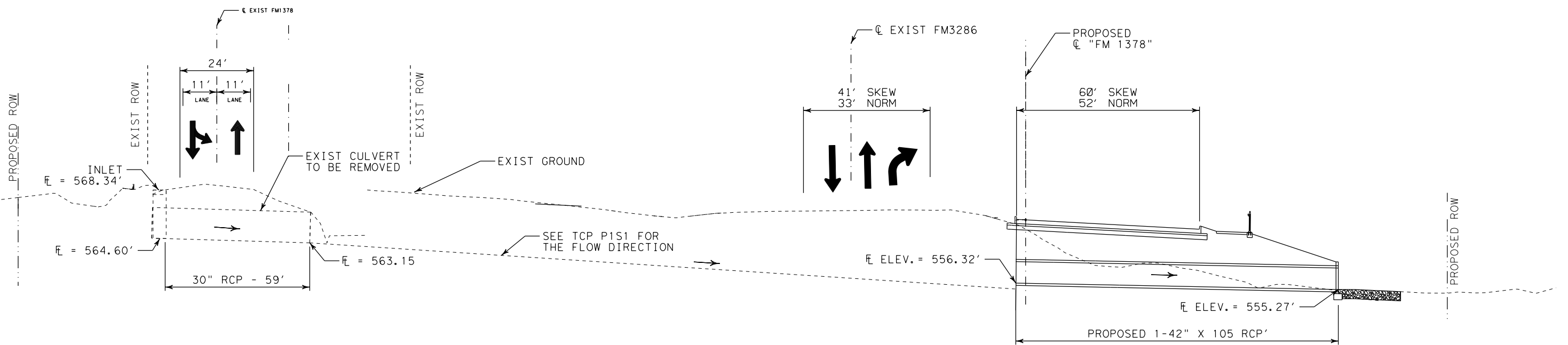

TYPICAL SECTION - PHASE 1 STAGE 1
CONSTRUCTING FM 3286 WBML

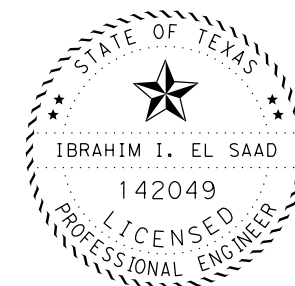

Abraham El Saad, P.E. 2-16-23
Signature of Registrant & Date

© 2023

Texas Department of Transportation

FM 1378
AT FM 3286
TRAFFIC CONTROL PLAN
CULVERT A

N. T. S.		SHEET 1 OF 2		
DESIGN	FED. RD. DIV. NO.	FEDERAL AID PROJECT NO.		HIGHWAY NO.
IIE	6	SEE TITLE SHEET		FM 1378, ETC.
GRAPHICS		STATE	DISTRICT	COUNTY
IIE		TEXAS	DAL	COLLIN
CHECK		CONTROL	SECTION	JOB
IIE		1392	01	044, ETC.

72

DATE: 2/16/2023 TIME: 10:52:55 AM FILE: c:\txdot\pw\onl\ine\txdot5\ibrahim.elsaad\0485472\Culvert A.dgn

DATE: 2/16/2023 TIME: 10:52:57 AM FILE: c:\txdot\pw\onl\ine\txdot5\ibrahim.elisaad\0485472\Culvert A.dgn

LEGEND

- ◻ PERMANENT CONSTRUCTION THIS PHASE
- PERMANENT CONSTRUCTION PREVIOUS PHASE

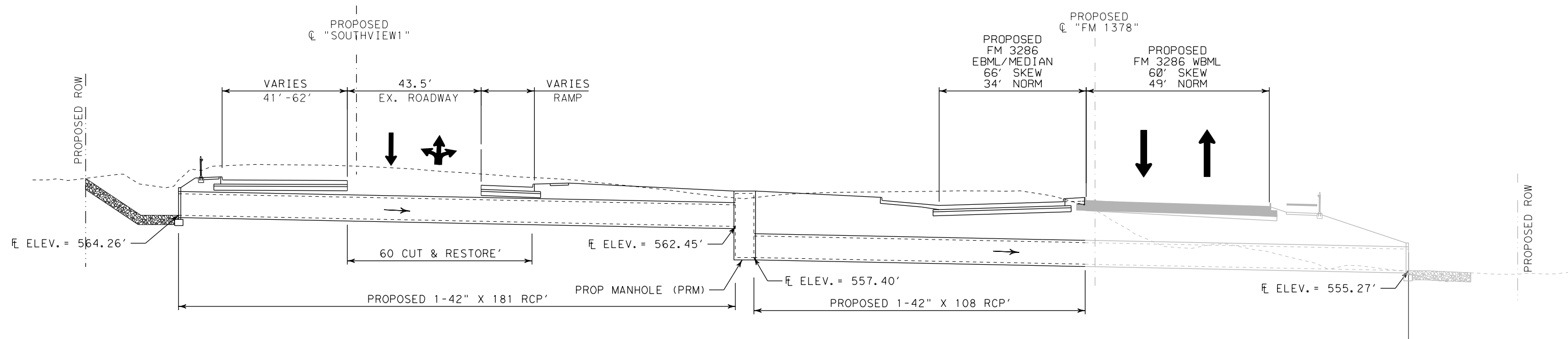

TYPICAL SECTION - PHASE 1 STAGE 2
 CONSTRUCTING FM 3286 EBML/MEDIAN
 FM 1378 SBML

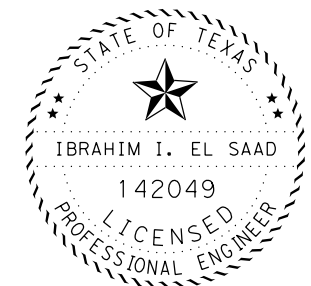

Abraham El Saad, P.E. 2-16-23
 Signature of Registrant & Date



FM 1378
 AT FM 3286
**TRAFFIC CONTROL PLAN
 CULVERT A**

N. T. S.			SHEET 2 OF 2	
DESIGN	FED. RD. DIV. NO.	FEDERAL AID PROJECT NO.		HIGHWAY NO.
IIE	6	SEE TITLE SHEET		FM 1378, ETC.
GRAPHICS		STATE	DISTRICT	COUNTY
IIE		TEXAS	DAL	COLLIN
CHECK		CONTROL	SECTION	JOB
SM/JI		1392	01	044, ETC.
CHECK				73
SM/JI				

DATE: 2/16/2023 TIME: 10:53:03 AM FILE: c:\txdot\pw\online\txdot5\ibrahim.e.issaad\0485472\Culvert B.dgn

LEGEND

- PERMANENT CONSTRUCTION THIS PHASE
- PERMANENT CONSTRUCTION PREVIOUS PHASE

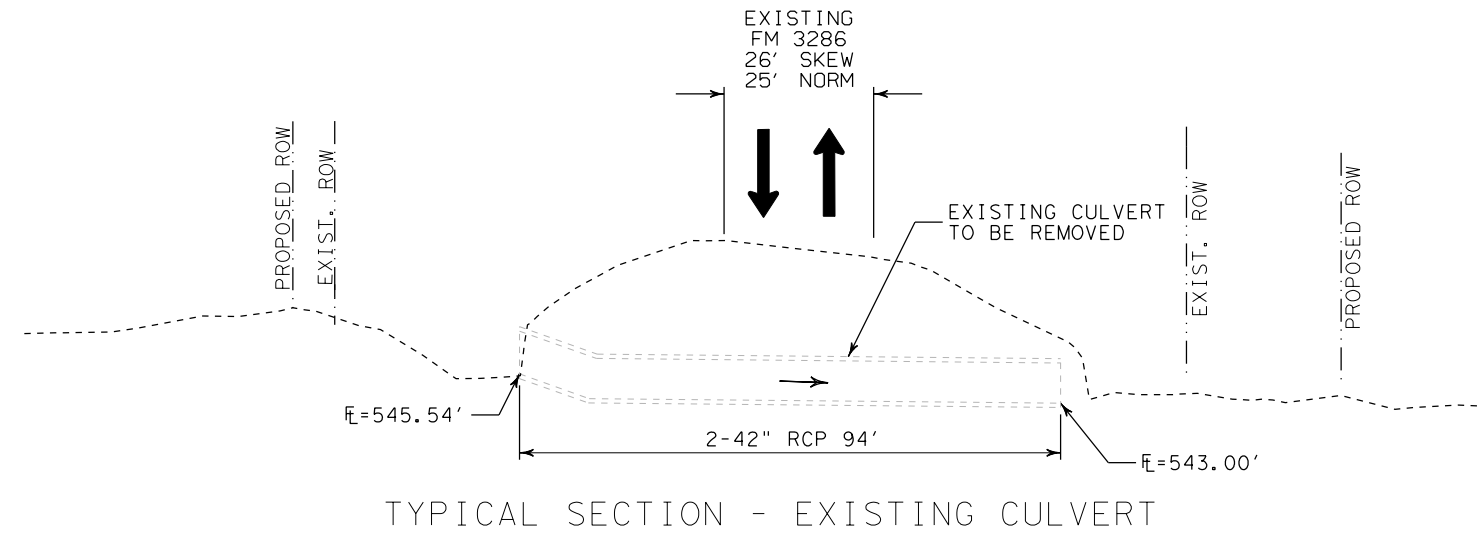

TYPICAL SECTION - EXISTING CULVERT

Culvert B

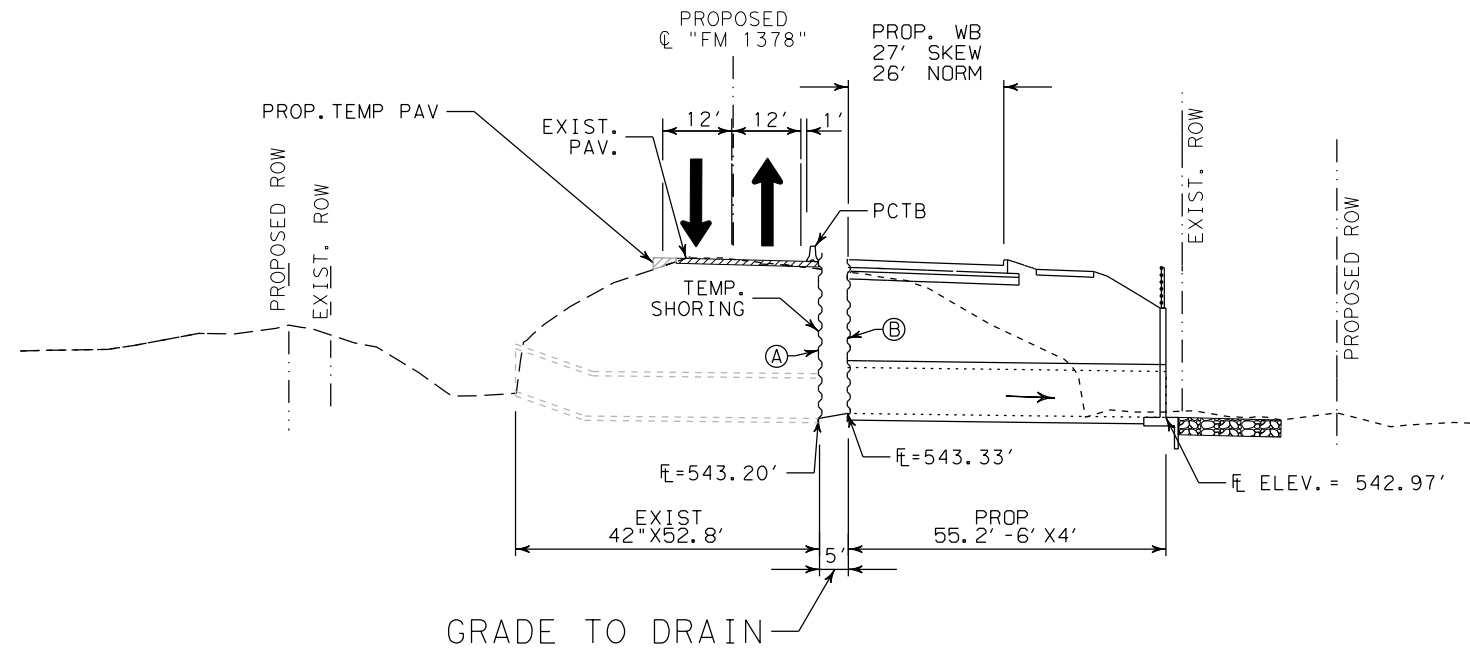
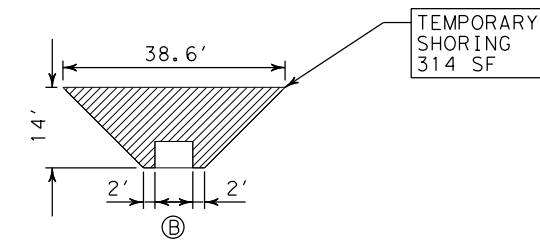
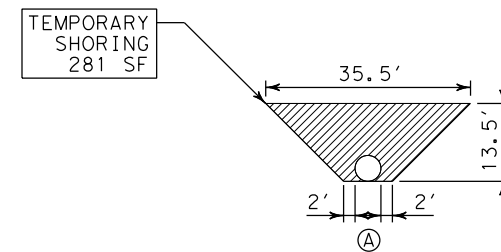

TYPICAL SECTION - PHASE 1 STAGE 1
CONSTRUCTING FM 3286 WBML AND EB OUTSIDE LANE

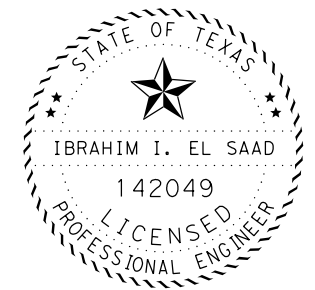

Abraham El Saad, P.E. 2-16-23
Signature of Registrant & Date



FM 1378
AT FM 3286
TRAFFIC CONTROL PLAN
CULVERT B

N. T. S.			SHEET 1 OF 2
DESIGN	FED. RD. DIV. NO.	FEDERAL AID PROJECT NO.	HIGHWAY NO.
IIE	6	SEE TITLE SHEET	FM 1378, ETC.
GRAPHICS	STATE	DISTRICT	COUNTY
IIE	TEXAS	DAL	COLLIN
CHECK	CONTROL	SECTION	JOB
SM/JI	1392	01	044, ETC.
CHECK	74		
SM/JI			

DATE: 2/16/2023 TIME: 10:53:05 AM FILE: c:\txdot\pw\online\txdot5\ibrahim.e\saad\0485472\Culvert B.dgn

LEGEND

- PERMANENT CONSTRUCTION THIS PHASE
- PERMANENT CONSTRUCTION PREVIOUS PHASE

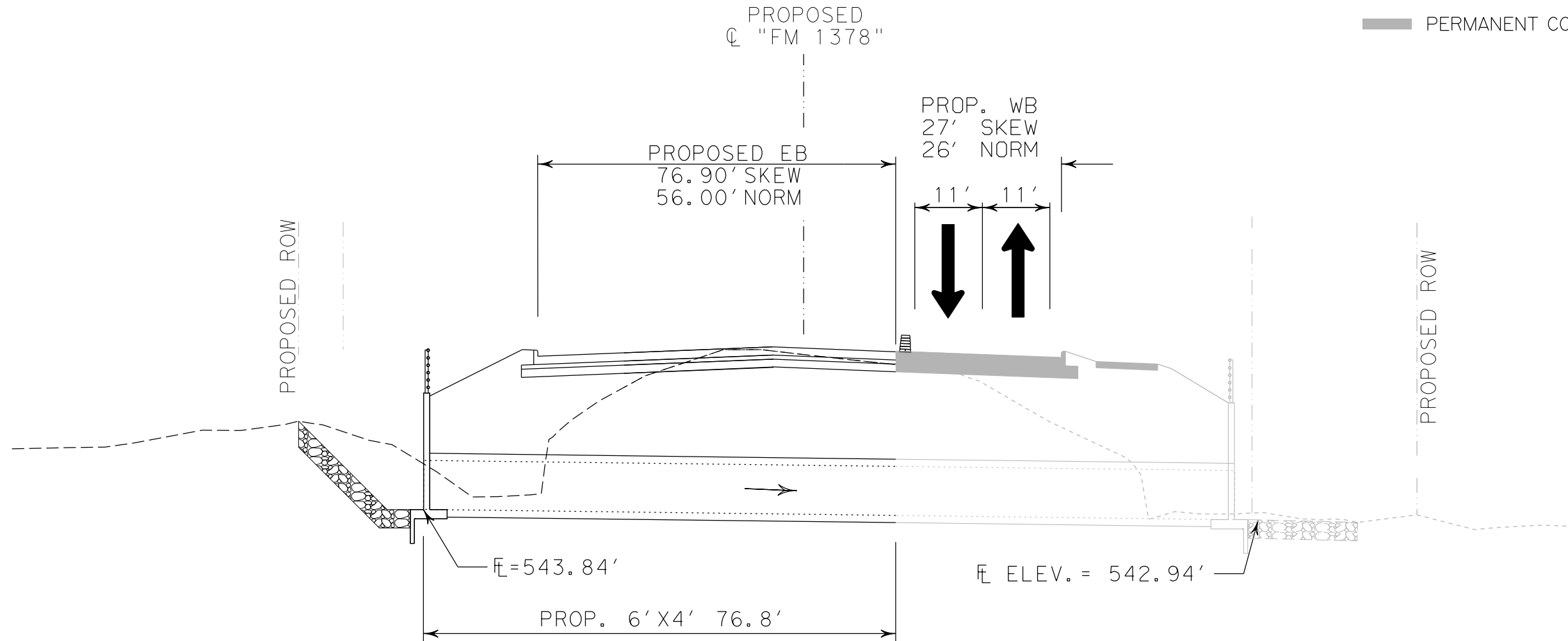

TYPICAL SECTION - PHASE 1 STAGE 2
CONSTRUCTING FM 3286 MEDIAN AND EB INSIDE LANE

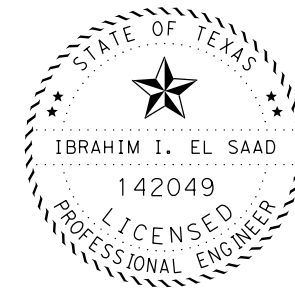

Abraham El Saad, P.E. 2-16-23
Signature of Registrant & Date

© 2023

Texas Department of Transportation

FM 1378
AT FM 3286
TRAFFIC CONTROL PLAN
CULVERT B

N. T. S. SHEET 2 OF 2

DESIGN	FED. RD. DIV. NO.	FEDERAL AID PROJECT NO.		HIGHWAY NO.
IIE	6	SEE TITLE SHEET		FM 1378, ETC.
GRAPHICS				
IIE	STATE	DISTRICT	COUNTY	SHEET NO.
CHECK	TEXAS	DAL	COLLIN	75
SM/JI	CONTROL	SECTION	JOB	
CHECK	1392	01	044, ETC.	
SM/JI				

DATE: 2/16/2023 TIME: 10:53:11 AM FILE: c:\txdot\pw\onl\ine\txdot5\ibrahim.e\saad\0485472\Culvert C.dgn

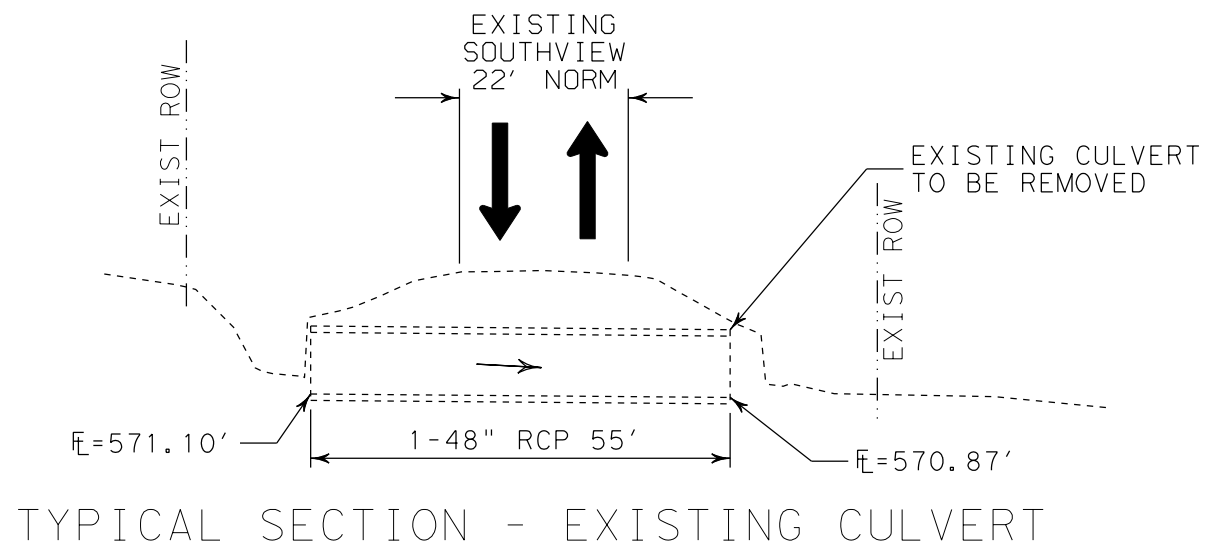

LEGEND

- PERMANENT CONSTRUCTION THIS PHASE
- PERMANENT CONSTRUCTION PREVIOUS PHASE

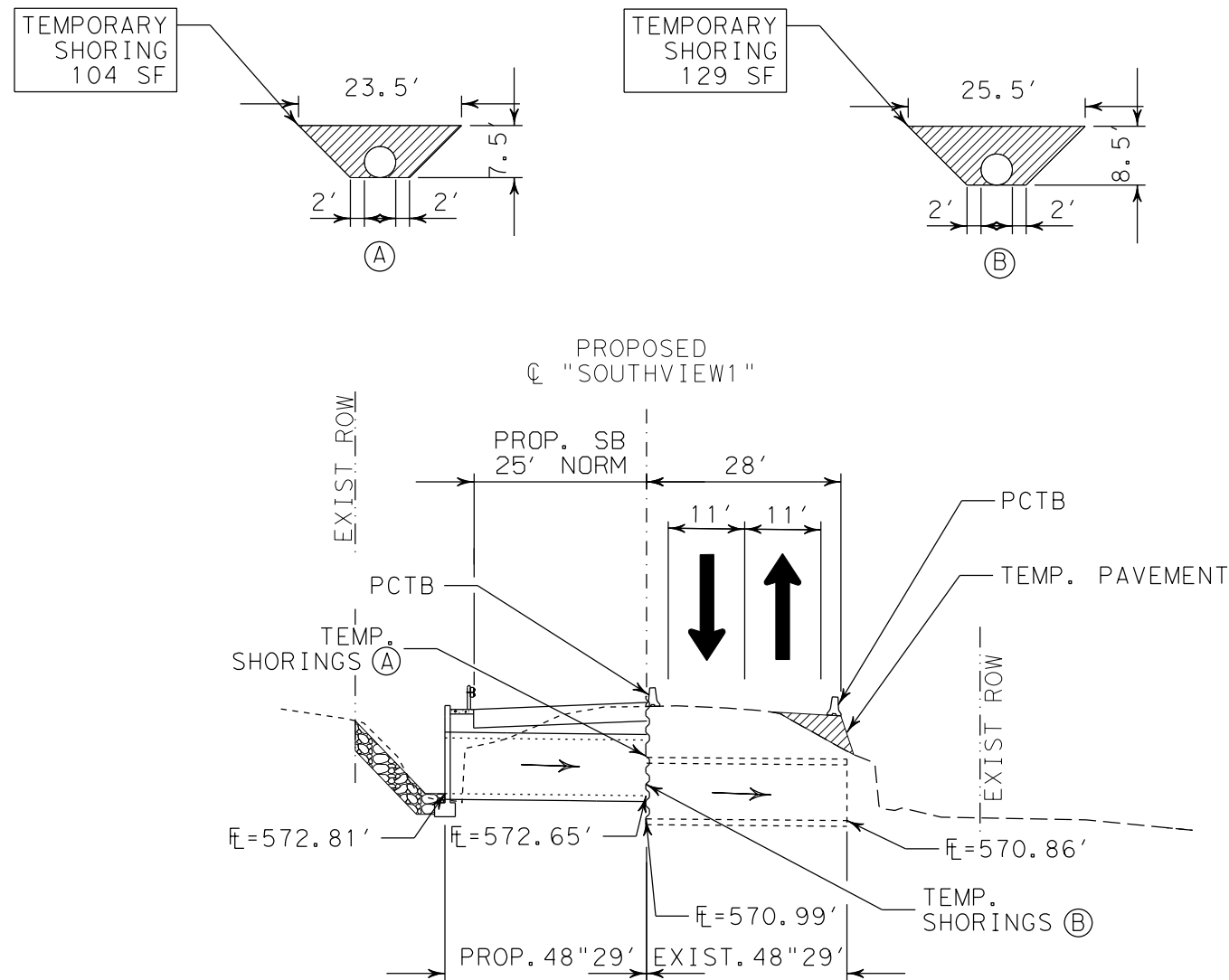

TYPICAL SECTION - PHASE 1 STAGE 2
CONSTRUCTING FM 1378 SBML

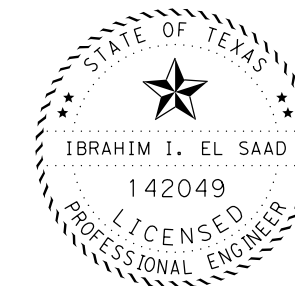

Abraham El Saad, P.E. 2-16-23
Signature of Registrant & Date

		© 2023	
FM 1378			
AT FM 3286			
TRAFFIC CONTROL PLAN			
CULVERT C			
N. T. S.		SHEET 1 OF 2	
DESIGN	FED. RD. DIV. NO.	FEDERAL AID PROJECT NO.	HIGHWAY NO.
IIE	6	SEE TITLE SHEET	FM 1378, ETC.
GRAPHICS	STATE	DISTRICT	COUNTY
IIE	TEXAS	DAL	COLLIN
CHECK	CONTROL	SECTION	JOB
SM/JI	1392	01	044, ETC.
CHECK			76
SM/JI			

DATE: 2/16/2023 TIME: 10:53:12 AM FILE: c:\txdot\pw\onl\ine\txdot5\ibrahim.e\saad\0485472\Culvert C.dgn

LEGEND

- PERMANENT CONSTRUCTION THIS PHASE
- PERMANENT CONSTRUCTION PREVIOUS PHASE

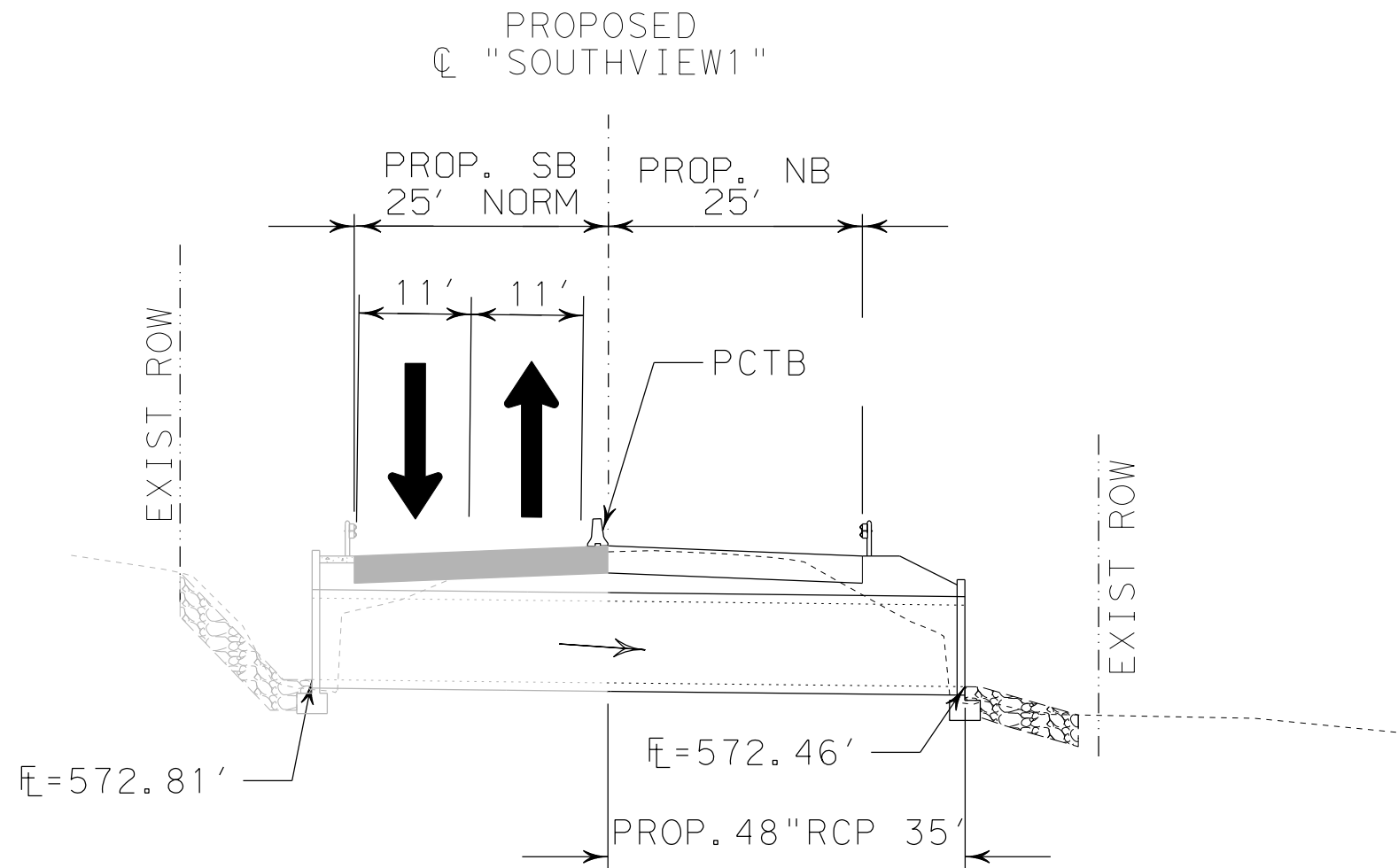

TYPICAL SECTION - PHASE 2 STAGE 1
CONSTRUCTING FM 1378 NBML

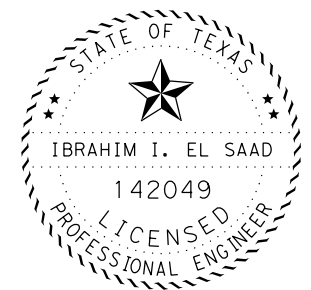

Abraham I. Saad, P.E. 2-16-23
Signature of Registrant & Date

Texas Department of Transportation				© 2023
FM 1378				
AT FM 3286				
TRAFFIC CONTROL PLAN				
CULVERT C				
N. T. S.		SHEET 2 OF 2		
DESIGN	FED. RD. DIV. NO.	FEDERAL AID PROJECT NO.		HIGHWAY NO.
IIE	6	SEE TITLE SHEET		FM 1378, ETC.
GRAPHICS	STATE	DISTRICT	COUNTY	SHEET NO.
IIE	TEXAS	DAL	COLLIN	77
CHECK SM/JI	CONTROL	SECTION	JOB	
CHECK SM/JI	1392	01	044, ETC.	

DISCLAIMER: The use of this standard is governed by the "Texas Engineering Practice Act". No warranty of any kind is made by TxDOT for any purpose whatsoever. TxDOT assumes no responsibility for the conversion of this standard to other formats or for incorrect results or damages resulting from its use.

DATE: 10/29/2022 9:04:37 PM
 FILE: c:\txdot\pw_online\txdot5\james.igwe\d0483941\bc-21.dgn

BARRICADE AND CONSTRUCTION (BC) STANDARD SHEETS GENERAL NOTES:

1. The Barricade and Construction Standard Sheets (BC sheets) are intended to show typical examples for placement of temporary traffic control devices, construction pavement markings, and typical work zone signs. The information contained in these sheets meet or exceed the requirements shown in the "Texas Manual on Uniform Traffic Control Devices" (TMUTCD).
2. The development and design of the Traffic Control Plan (TCP) is the responsibility of the Engineer.
3. The Contractor may propose changes to the TCP that are signed and sealed by a licensed professional engineer for approval. The Engineer may develop, sign and seal Contractor proposed changes.
4. The Contractor is responsible for installing and maintaining the traffic control devices as shown in the plans. The Contractor may not move or change the approximate location of any device without the approval of the Engineer.
5. Geometric design of lane shifts and detours should, when possible, meet the applicable design criteria contained in manuals such as the American Association of State Highway and Transportation Officials (AASHTO), "A Policy on Geometric Design of Highways and Streets," the TxDOT "Roadway Design Manual" or engineering judgment.
6. When projects abut, the Engineer(s) may omit the END ROAD WORK, TRAFFIC FINES DOUBLE, and other advance warning signs if the signing would be redundant and the work areas appear continuous to the motorists. If the adjacent project is completed first, the Contractor shall erect the necessary warning signs as shown on these sheets, the TCP sheets or as directed by the Engineer. The BEGIN ROAD WORK NEXT X MILES sign shall be revised to show appropriate work zone distance.
7. The Engineer may require duplicate warning signs on the median side of divided highways where median width will permit and traffic volumes justify the signing.
8. All signs shall be constructed in accordance with the details found in the "Standard Highway Sign Designs for Texas," latest edition. Sign details not shown in this manual shall be shown in the plans or the Engineer shall provide a detail to the Contractor before the sign is manufactured.
9. The temporary traffic control devices shown in the illustrations of the BC sheets are examples. As necessary, the Engineer will determine the most appropriate traffic control devices to be used.
10. Where highway construction or maintenance work is being undertaken, other than mobile operations as defined by the Texas Manual on Uniform Traffic Control Devices, CSJ limit signs are required. CSJ limit signs are shown on BC(2). The OBEY WARNING SIGNS STATE LAW sign, STAY ALERT TALK OR TEXT LATER and the WORK ZONE TRAFFIC FINES DOUBLE sign with plaque shall be erected in advance of the CSJ limits. The BEGIN ROAD WORK NEXT X MILES, CONTRACTOR and END ROAD WORK signs shall be erected at or near the CSJ limits. For mobile operations, CSJ limit signs are not required.
11. Traffic control devices should be in place only while work is actually in progress or a definite need exists.
12. The Engineer has the final decision on the location of all traffic control devices.
13. Inactive equipment and work vehicles, including workers' private vehicles must be parked away from travel lanes. They should be as close to the right-of-way line as possible, or located behind a barrier or guardrail, or as approved by the Engineer.

WORKER SAFETY NOTES:



1. Workers on foot who are exposed to traffic or to construction equipment within the right-of-way shall wear high-visibility safety apparel meeting the requirements of ISEA "American National Standard for High-Visibility Apparel," or equivalent revisions, and labeled as ANSI 107-2004 standard performance for Class 2 or 3 risk exposure. Class 3 garments should be considered for high traffic volume work areas or night time work.
2. Except in emergency situations, flagger stations shall be illuminated when flagging is used at night.

COMPLIANT WORKZONE TRAFFIC CONTROL DEVICES

1. Only pre-qualified products shall be used. The "Compliant Work Zone Traffic Control Devices List" (CWZTCD) describes pre-qualified products and their sources.
2. Work zone traffic control devices shall be compliant with the Manual for Assessing safety Hardware (MASH).

THE DOCUMENTS BELOW CAN BE FOUND ON-LINE AT http://www.txdot.gov
COMPLIANT WORK ZONE TRAFFIC CONTROL DEVICES LIST (CWZTCD)
DEPARTMENTAL MATERIAL SPECIFICATIONS (DMS)
MATERIAL PRODUCER LIST (MPL)
ROADWAY DESIGN MANUAL - SEE "MANUALS (ONLINE MANUALS) "
STANDARD HIGHWAY SIGN DESIGNS FOR TEXAS (SHSD)
TEXAS MANUAL ON UNIFORM TRAFFIC CONTROL DEVICES (TMUTCD)
TRAFFIC ENGINEERING STANDARD SHEETS

SHEET 1 OF 12

		
BARRICADE AND CONSTRUCTION GENERAL NOTES AND REQUIREMENTS		
BC (1) - 21		
FILE:	bc-21.dgn	DN: TxDOT
© TxDOT	November 2002	ck: TxDOT
REVISIONS	1392 01	DW: TxDOT
4-03	7-13	JOB
9-07	8-14	HIGHWAY
5-10	5-21	044, ETC. FM 1378, ETC.
DIST	COUNTY	SHEET NO.
DAL	COLLIN	78

DISCLAIMER: The use of this standard is governed by the "Texas Engineering Practice Act". No warranty of any kind is made by TxDOT for any purpose whatsoever. TxDOT assumes no responsibility for the conversion of this standard to other formats or for incorrect results or damages resulting from its use.

DATE: 10/29/2022 9:04:38 PM
 FILE: c:\txdot\pw_online\james.igwe\d0483941\bc-21.dgn

TYPICAL LOCATION OF CROSSROAD SIGNS

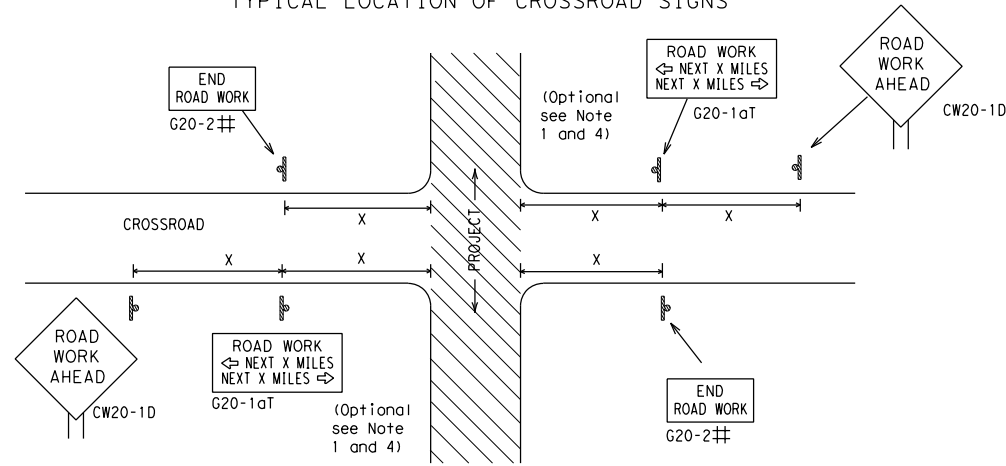

- ## May be mounted on back of "ROAD WORK AHEAD" (CW20-1D) sign with approval of Engineer. (See note 2 below)
- The typical minimum signing on a crossroad approach should be a "ROAD WORK AHEAD" (CW20-1D) sign and a (G20-2) "END ROAD WORK" sign, unless noted otherwise in plans.
 - The Engineer may use the reduced size 36" x 36" ROAD WORK AHEAD (CW20-1D) sign mounted back to back with the reduced size 36" x 18" "END ROAD WORK" (G20-2) sign on low volume crossroads (see Note 4 under "Typical Construction Warning Sign Size and Spacing"). See the "Standard Highway Sign Designs for Texas" manual for sign details. The Engineer may omit the advance warning signs on low volume crossroads. The Engineer will determine whether a road is low volume as per TMUTCD Part 5. This information shall be shown in the plans.
 - Based on existing field conditions, the Engineer/Inspector may require additional signs such as FLAGGER AHEAD, LOOSE GRAVEL, or other appropriate signs. When additional signs are required, these signs will be considered part of the minimum requirements. The Engineer/Inspector will determine the proper location and spacing of any sign not shown on the BC sheets, Traffic Control Plan sheets or the Work Zone Standard Sheets.
 - The "ROAD WORK NEXT X MILES" (G20-1aT) sign shall be required at high volume crossroads to advise motorists of the length of construction in either direction from the intersection. The Engineer will determine whether a roadway is considered high volume.
 - Additional traffic control devices may be shown elsewhere in the plans for higher volume crossroads.
 - When work occurs in the intersection area, appropriate traffic control devices, as shown elsewhere in the plans or as determined by the Engineer/Inspector, shall be in place.

T-INTERSECTION

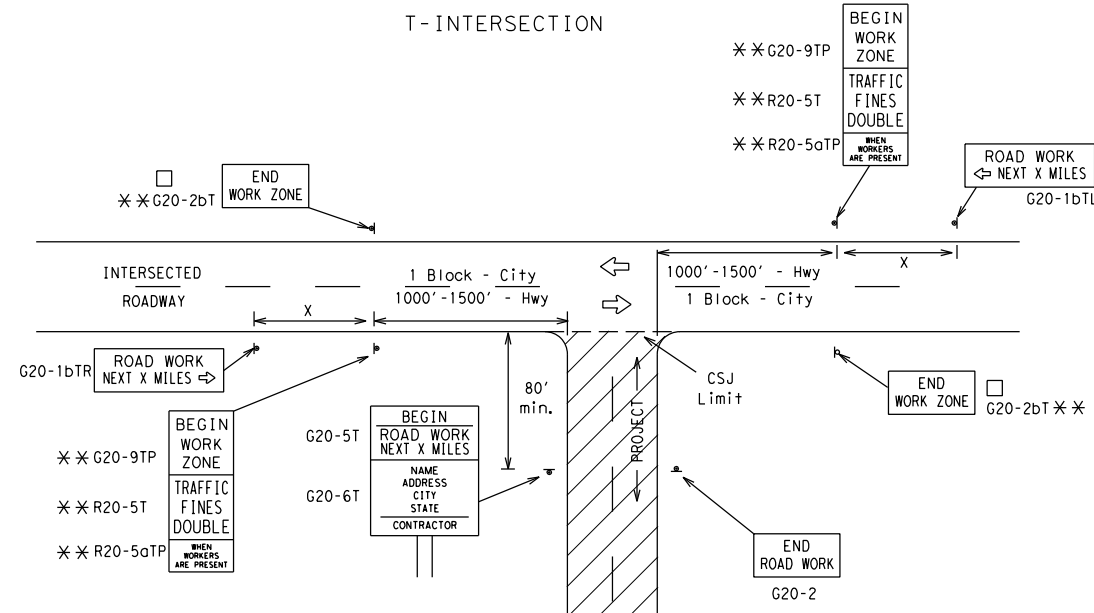

CSJ LIMITS AT T-INTERSECTION

- The Engineer will determine the types and location of any additional traffic control devices, such as a flagger and accompanying signs, or other signs, that should be used when work is being performed at or near an intersection.
- If construction closes the road at a T-intersection, the Contractor shall place the "CONTRACTOR NAME" (G20-6T) sign behind the Type 3 Barricades for the road closure (see BC(10) also). The "ROAD WORK NEXT X MILES" left arrow (G20-1bTL) and "ROAD WORK NEXT X MILES" right arrow (G20-1bTR) signs shall be replaced by the detour signing called for in the plans.

TYPICAL CONSTRUCTION WARNING SIGN SIZE AND SPACING^{1,5,6}

Sign Number or Series	SIZE		SPACING	
	Conventional Road	Expressway/Freeway	Posted Speed MPH	Sign Δ Spacing "x" Feet (Apprx.)
CW20 ⁴	48" x 48"	48" x 48"	30	120
CW21			35	160
CW22			40	240
CW23			45	320
CW1, CW2, CW7, CW8, CW9, CW11, CW14	36" x 36"	48" x 48"	50	400
CW3, CW4, CW5, CW6, CW8-3, CW10, CW12	48" x 48"	48" x 48"	60	600 ²
			65	700 ²
			70	800 ²
			80	1000 ²
*			*	* ³

* For typical sign spacings on divided highways, expressways and freeways, see Part 6 of the "Texas Manual on Uniform Traffic Control Devices" (TMUTCD) typical application diagrams or TCP Standard Sheets.

Δ Minimum distance from work area to first Advance Warning sign nearest the work area and/or distance between each additional sign.

GENERAL NOTES

- Special or larger size signs may be used as necessary.
- Distance between signs should be increased as required to have 1500 feet advance warning.
- Distance between signs should be increased as required to have 1/2 mile or more advance warning.
- 36" x 36" "ROAD WORK AHEAD" (CW20-1D) signs may be used on low volume crossroads at the discretion of the Engineer as per TMUTCD Part 5. See Note 2 under "Typical Location of Crossroad Signs".
- Only diamond shaped warning sign sizes are indicated.
- See sign size listing in "TMUTCD", Sign Appendix or the "Standard Highway Sign Designs for Texas" manual for complete list of available sign design sizes.

WORK AREAS IN MULTIPLE LOCATIONS WITHIN CSJ LIMITS

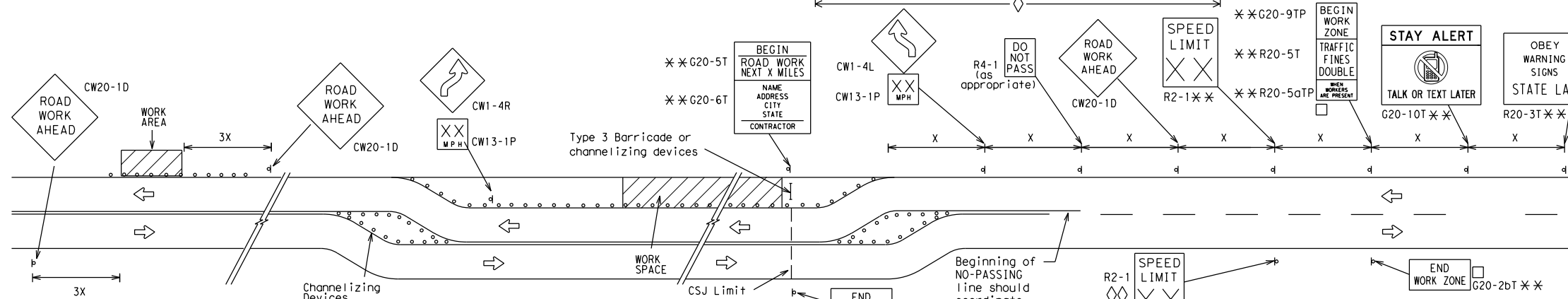

When extended distances occur between minimal work spaces, the Engineer/Inspector should ensure additional "ROAD WORK AHEAD" (CW20-1D) signs are placed in advance of these work areas to remind drivers they are still within the project limits. See the applicable TCP sheets for exact location and spacing of signs and channelizing devices.

SAMPLE LAYOUT OF SIGNING FOR WORK BEGINNING DOWNSTREAM OF THE CSJ LIMITS

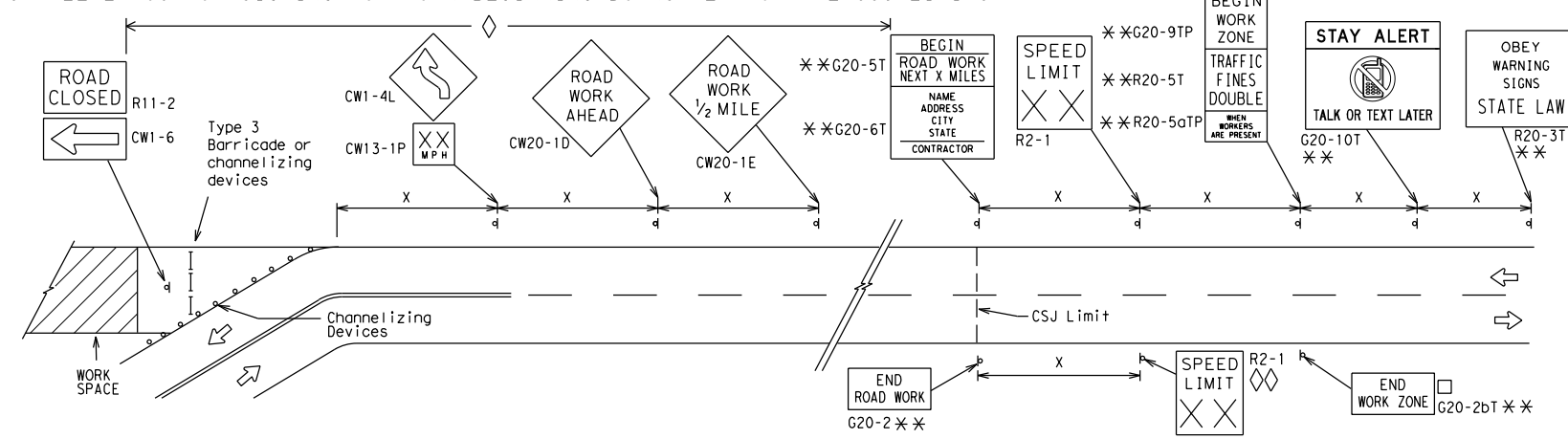

SAMPLE LAYOUT OF SIGNING FOR WORK BEGINNING AT THE CSJ LIMITS

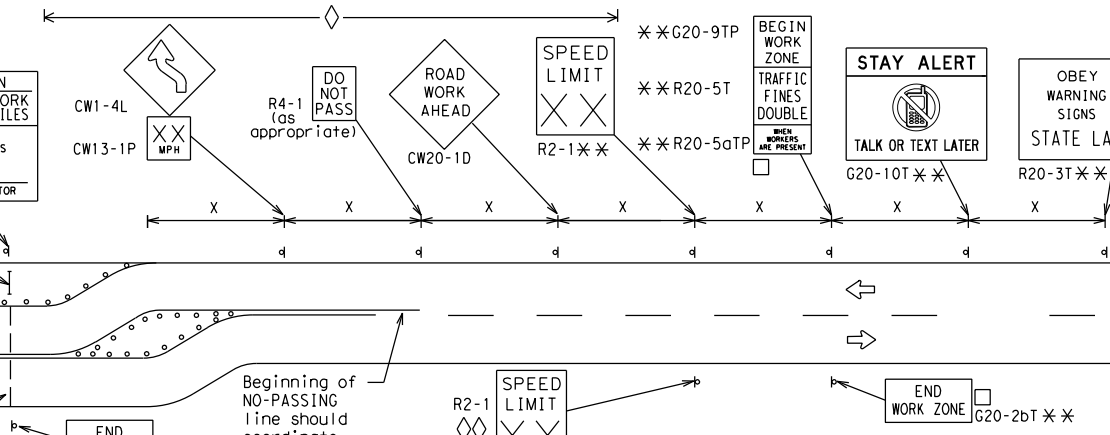

NOTES

- The Contractor shall determine the appropriate distance to be placed on the G20-1 series signs and "BEGIN ROAD WORK NEXT X MILES" (G20-5T) sign for each specific project. This distance shall replace the "x" and shall be rounded to the nearest whole mile with the approval of the Engineer. No decimals shall be used.
- The "BEGIN WORK ZONE" (G20-9TP) and "END WORK ZONE" (G20-2bT) shall be used as shown on the sample layout when advance signs are required outside the CSJ Limits. They inform the motorist of entering or leaving a part of the work zone lying outside the CSJ Limits where traffic fines may double if workers are present.
- CSJ limit signing is required for highway construction and maintenance work, with the exception of mobile operations.
- Area for placement of "ROAD WORK AHEAD" (CW20-1D) sign and other signs or devices as called for on the Traffic Control Plan.
- Contractor will install a regulatory speed limit sign at the end of the work zone.

LEGEND	
—	Type 3 Barricade
○ ○ ○	Channelizing Devices
■	Sign
X	See Typical Construction Warning Sign Size and Spacing chart or the TMUTCD for sign spacing requirements.

SHEET 2 OF 12



BARRICADE AND CONSTRUCTION PROJECT LIMIT

BC(2)-21

FILE: bc-21.dgn	DN: TxDOT	CK: TxDOT	DW: TxDOT	CK: TxDOT
©TxDOT November 2002	CONT	SECT	JOB	HIGHWAY
REVISIONS	1392	01	044, ETC.FM 1378, ETC.	
9-07 8-14	DIST	COUNTY	SHEET NO.	
7-13 5-21	DAL	COLLIN	79	

TYPICAL APPLICATION OF WORK ZONE SPEED LIMIT SIGNS

Work zone speed limits shall be regulatory, established in accordance with the "Procedures for Establishing Speed Zones," and approved by the Texas Transportation Commission, or by City Ordinance when within Incorporated City Limits.

Reduced speeds should only be posted in the vicinity of work activity and not throughout the entire project. Regulatory work zone speed signs (R2-1) shall be removed or covered during periods when they are not needed.

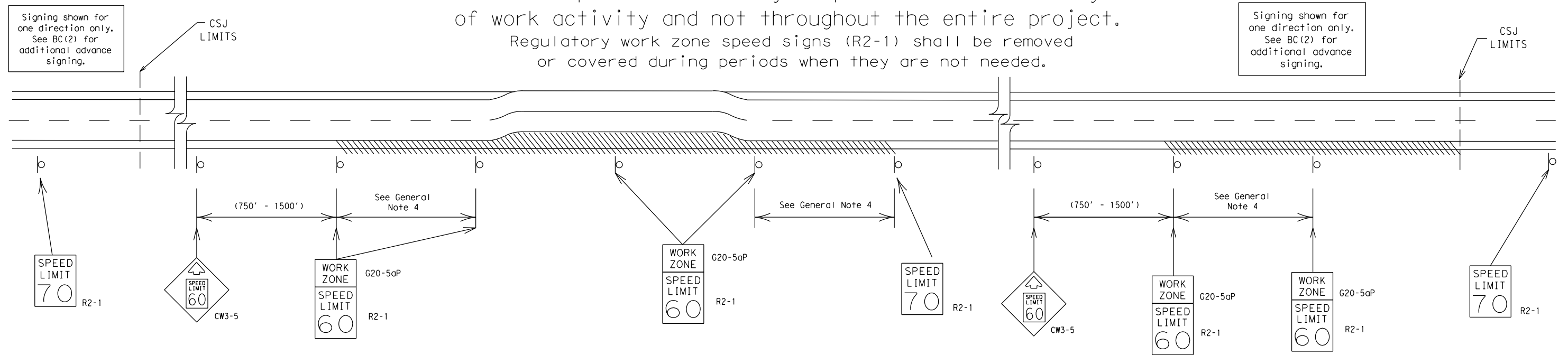

GUIDANCE FOR USE:

LONG/INTERMEDIATE TERM WORK ZONE SPEED LIMITS

This type of work zone speed limit should be included on the design of the traffic control plans when restricted geometrics with a lower design speed are present in the work zone and modification of the geometrics to a higher design speed is not feasible.

Long/Intermediate Term Work Zone Speed Limit signs, when approved as described above, should be posted and visible to the motorist when work activity is present. Work activity may also be defined as a change in the roadway that requires a reduced speed for motorists to safely negotiate the work area, including:

- rough road or damaged pavement surface
- substantial alteration of roadway geometrics (diversions)
- construction detours
- grade
- width
- other conditions readily apparent to the driver

As long as any of these conditions exist, the work zone speed limit signs should remain in place.

SHORT TERM WORK ZONE SPEED LIMITS

This type of work zone speed limit may be included on the design of the traffic control plans when workers or equipment are not behind concrete barrier, when work activity is within 10 feet of the traveled way or actually in the traveled way.

Short Term Work Zone Speed Limit signs should be posted and visible to the motorists only when work activity is present. When work activity is not present, signs shall be removed or covered. (See Removing or Covering on BC(4)).

GENERAL NOTES

- Regulatory work zone speed limits should be used only for sections of construction projects where speed control is of major importance.
- Regulatory work zone speed limit signs shall be placed on supports at a 7 foot minimum mounting height.
- Speed zone signs are illustrated for one direction of travel and are normally posted for each direction of travel.
- Frequency of work zone speed limit signs should be:

40 mph and greater	0.2 to 2 miles
35 mph and less	0.2 to 1 mile
- Regulatory speed limit signs shall have black legend and border on a white reflective background (See "Reflective Sheeting" on BC(4)).
- Fabrication, erection and maintenance of the "ADVANCE SPEED LIMIT" (CW3-5) sign, "WORK ZONE" (G20-5aP) plaque and the "SPEED LIMIT" (R2-1) signs shall not be paid for directly, but shall be considered subsidiary to Item 502.
- Turning signs from view, laying signs over or down will not be allowed, unless as otherwise noted under "REMOVING OR COVERING" on BC(4).
- Techniques that may help reduce traffic speeds include but are not limited to:
 - Law enforcement.
 - Flagger stationed next to sign.
 - Portable changeable message sign (PCMS).
 - Low-power (drone) radar transmitter.
 - Speed monitor trailers or signs.
- Speeds shown on details above are for illustration only. Work Zone Speed Limits should only be posted as approved for each project.
- For more specific guidance concerning the type of work, work zone conditions and factors impacting allowable regulatory construction speed zone reduction see TxDOT form #1204 in the TxDOT e-form system.

DISCLAIMER: The use of this standard is governed by the "Texas Engineering Practice Act". No warranty of any kind is made by TxDOT for any purpose whatsoever. TxDOT assumes no responsibility for the conversion of this standard to other formats or for incorrect results or damages resulting from its use.

DATE: 10/29/2022 9:04:40 PM
FILE: c:\txdot\pw_online\txdot5\james.igwe\d0483941\bc-21.dgn

SHEET 3 OF 12

<h2>BARRICADE AND CONSTRUCTION WORK ZONE SPEED LIMIT</h2>			
<h3>BC (3) - 21</h3>			
FILE:	bc-21.dgn	DN: TxDOT	ck: TxDOT
© TxDOT	November 2002	CONT	SECT
REVISIONS		1392	01
9-07	8-14	044, ETC. FM 1378, ETC.	
7-13	5-21	DIST	COUNTY
		DAL	COLLIN
			SHEET NO.
			80

DISCLAIMER: The use of this standard is governed by the "Texas Engineering Practice Act". No warranty of any kind is made by TxDOT for any purpose whatsoever. TxDOT assumes no responsibility for the conversion of this standard to other formats or for incorrect results or damages resulting from its use.

TYPICAL MINIMUM CLEARANCES FOR LONG TERM AND INTERMEDIATE TERM SIGNS

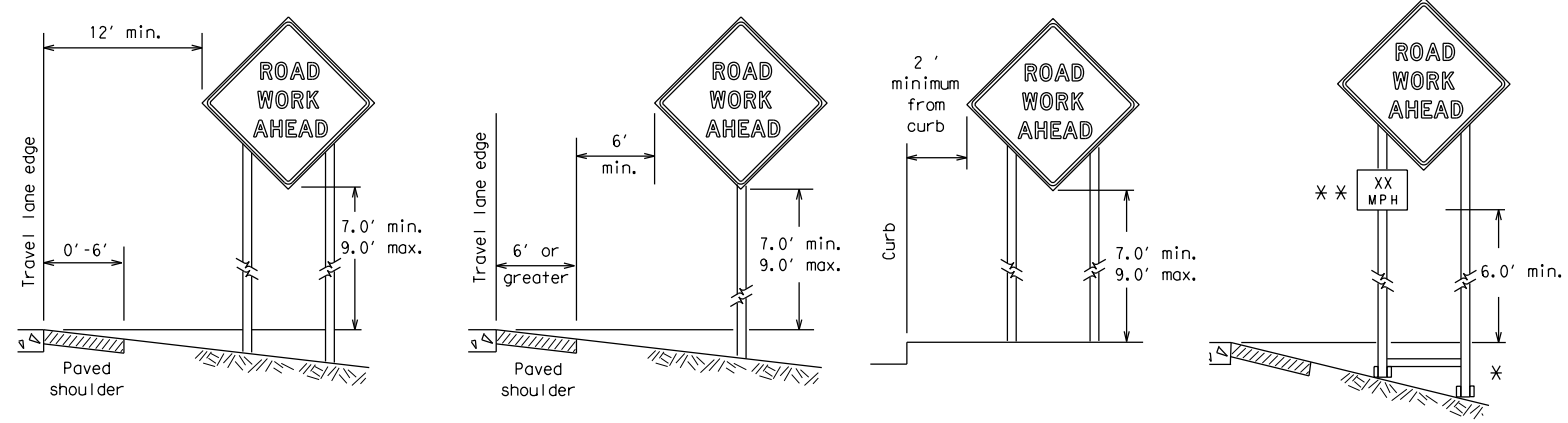

* When placing skid supports on unlevel ground, the leg post lengths must be adjusted so the sign appears straight and plumb. Objects shall NOT be placed under skids as a means of leveling.

** When plaques are placed on dual-leg supports, they should be attached to the upright nearest the travel lane. Supplemental plaques (advisory or distance) should not cover the surface of the parent sign.

ATTACHMENT FOR SIGN SUPPORTS

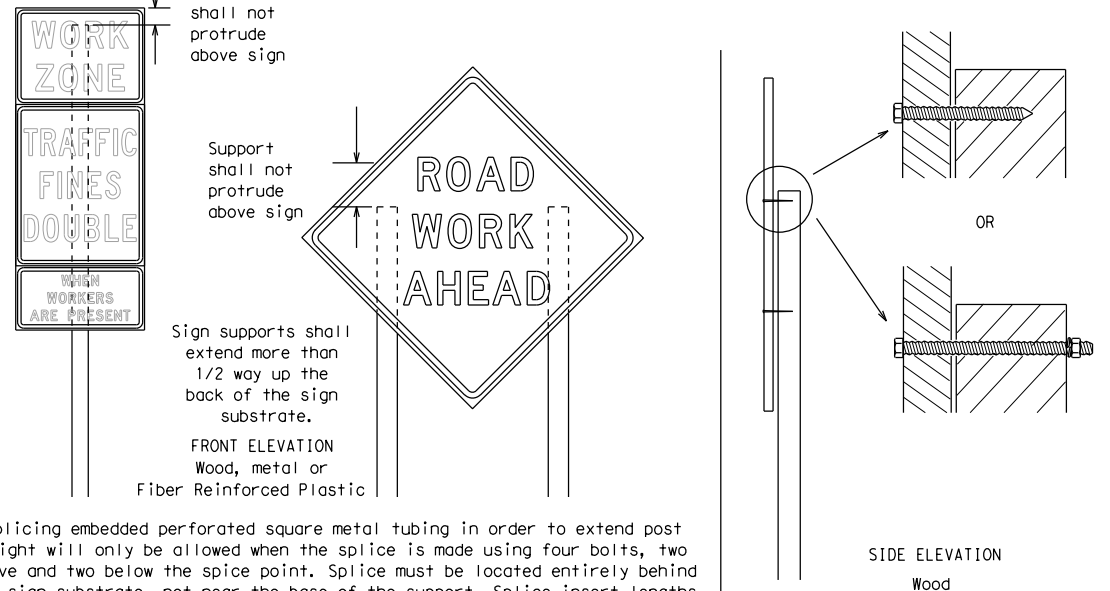

Splicing embedded perforated square metal tubing in order to extend post height will only be allowed when the splice is made using four bolts, two above and two below the splice point. Splice must be located entirely behind the sign substrate, not near the base of the support. Splice insert lengths should be at least 5 times nominal post size, centered on the splice and of at least the same gauge material.

GENERAL NOTES FOR WORK ZONE SIGNS

- Contractor shall install and maintain signs in a straight and plumb condition and/or as directed by the Engineer.
- Wooden sign posts shall be painted white.
- Barricades shall NOT be used as sign supports.
- All signs shall be installed in accordance with the plans or as directed by the Engineer. Signs shall be used to regulate, warn, and guide the traveling public safely through the work zone.
- The Contractor may furnish either the sign design shown in the plans or in the "Standard Highway Sign Designs for Texas" (SHSD). The Engineer/Inspector may require the Contractor to furnish other work zone signs that are shown in the TMUTCD but may have been omitted from the plans. Any variation in the plans shall be documented by written agreement between the Engineer and the Contractor's Responsible Person. All changes must be documented in writing before being implemented. This can include documenting the changes in the Inspector's TxDOT diary and having both the Inspector and Contractor initial and date the agreed upon changes.
- The Contractor shall furnish sign supports listed in the "Compliant Work Zone Traffic Control Device List" (CWZTCD) for small roadside signs. Supports for temporary large roadside signs shall meet the requirements detailed on the Temporary Large Roadside Signs (TLRS) standard sheets. The Contractor shall install the sign support in accordance with the manufacturer's recommendations. If there is a question regarding installation procedures, the Contractor shall furnish the Engineer a copy of the manufacturer's installation recommendations so the Engineer can verify the correct procedures are being followed.
- The Contractor is responsible for installing signs on approved supports and replacing signs with damaged or cracked substrates and/or damaged or marred reflective sheeting as directed by the Engineer/Inspector.
- Identification markings may be shown only on the back of the sign substrate. The maximum height of letters and/or company logos used for identification shall be 1 inch.
- The Contractor shall replace damaged wood posts. New or damaged wood sign posts shall not be spliced.

DURATION OF WORK (as defined by the "Texas Manual on Uniform Traffic Control Devices" Part 6)

- The types of sign supports, sign mounting height, the size of signs, and the type of sign substrates can vary based on the type of work being performed. The Engineer is responsible for selecting the appropriate size sign for the type of work being performed. The Contractor is responsible for ensuring the sign support, sign mounting height and substrate meets manufacturer's recommendations in regard to crashworthiness and duration of work requirements.
 - Long-term stationary - work that occupies a location more than 3 days.
 - Intermediate-term stationary - work that occupies a location more than one daylight period up to 3 days, or nighttime work lasting more than one hour.
 - Short-term stationary - daytime work that occupies a location for more than 1 hour in a single daylight period.
 - Short, duration - work that occupies a location up to 1 hour.
 - Mobile - work that moves continuously or intermittently (stopping for up to approximately 15 minutes.)

SIGN MOUNTING HEIGHT

- The bottom of Long-term/Intermediate-term signs shall be at least 7 feet, but not more than 9 feet, above the paved surface, except as shown for supplemental plaques mounted below other signs.
- The bottom of Short-term/Short Duration signs shall be a minimum of 1 foot above the pavement surface but no more than 2 feet above the ground.
- Long-term/Intermediate-term Signs may be used in lieu of Short-term/Short Duration signing.
- Short-term/Short Duration signs shall be used only during daylight and shall be removed at the end of the workday or raised to appropriate Long-term/Intermediate sign height.
- Regulatory signs shall be mounted at least 7 feet, but not more than 9 feet, above the paved surface regardless of work duration.

SIZE OF SIGNS

- The Contractor shall furnish the sign sizes shown on BC (2) unless otherwise shown in the plans or as directed by the Engineer.

SIGN SUBSTRATES

- The Contractor shall ensure the sign substrate is installed in accordance with the manufacturer's recommendations for the type of sign support that is being used. The CWZTCD lists each substrate that can be used on the different types and models of sign supports.
- "Mesh" type materials are NOT an approved sign substrate, regardless of the tightness of the weave.
- All wooden individual sign panels fabricated from 2 or more pieces shall have one or more plywood cleat, 1/2" thick by 6" wide, fastened to the back of the sign and extending fully across the sign. The cleat shall be attached to the back of the sign using wood screws that do not penetrate the face of the sign panel. The screws shall be placed on both sides of the splice and spaced at 6" centers. The Engineer may approve other methods of splicing the sign face.

REFLECTIVE SHEETING

- All signs shall be retroreflective and constructed of sheeting meeting the color and retro-reflectivity requirements of DMS-8300 for rigid signs or DMS-8310 for roll-up signs. The web address for DMS specifications is shown on BC(1).
- White sheeting, meeting the requirements of DMS-8300 Type A, shall be used for signs with a white background.
- Orange sheeting, meeting the requirements of DMS-8300 Type B_{FL} or Type C_{FL}, shall be used for rigid signs with orange backgrounds.

SIGN LETTERS

- All sign letters and numbers shall be clear, and open rounded type uppercase alphabet letters as approved by the Federal Highway Administration (FHWA) and as published in the "Standard Highway Sign Design for Texas" manual. Signs, letters and numbers shall be of first class workmanship in accordance with Department Standards and Specifications.

REMOVING OR COVERING

- When sign messages may be confusing or do not apply, the signs shall be removed or completely covered.
- Long-term stationary or intermediate stationary signs installed on square metal tubing may be turned away from traffic 90 degrees when the sign message is not applicable. This technique may not be used for signs installed in the median of divided highways or near any intersections where the sign may be seen from approaching traffic.
- Signs installed on wooden skids shall not be turned at 90 degree angles to the roadway. These signs should be removed or completely covered when not required.
- When signs are covered, the material used shall be opaque, such as heavy mil black plastic, or other materials which will cover the entire sign face and maintain their opaque properties under automobile headlights at night, without damaging the sign sheeting.
- Burlap shall NOT be used to cover signs.
- Duct tape or other adhesive material shall NOT be affixed to a sign face.
- Signs and anchor stubs shall be removed and holes backfilled upon completion of work.

SIGN SUPPORT WEIGHTS

- Where sign supports require the use of weights to keep from turning over, the use of sandbags with dry, cohesionless sand should be used.
- The sandbags will be tied shut to keep the sand from spilling and to maintain a constant weight.
- Rock, concrete, iron, steel or other solid objects shall not be permitted for use as sign support weights.
- Sandbags should weigh a minimum of 35 lbs and a maximum of 50 lbs.
- Sandbags shall be made of a durable material that tears upon vehicular impact. Rubber (such as tire inner tubes) shall NOT be used.
- Rubber ballasts designed for channelizing devices should not be used for ballast on portable sign supports. Sign supports designed and manufactured with rubber bases may be used when shown on the CWZTCD list.
- Sandbags shall only be placed along or laid over the base supports of the traffic control device and shall not be suspended above ground level or hung with rope, wire, chains or other fasteners. Sandbags shall be placed along the length of the skids to weigh down the sign support.
- Sandbags shall NOT be placed under the skid and shall not be used to level sign supports placed on slopes.

FLAGS ON SIGNS

- Flags may be used to draw attention to warning signs. When used, the flag shall be 16 inches square or larger and shall be orange or fluorescent red-orange in color. Flags shall not be allowed to cover any portion of the sign face.

STOP/SLOW PADDLES

- STOP/SLOW paddles are the primary method to control traffic by flaggers. The STOP/SLOW paddle size should be 24" x 24".
- STOP/SLOW paddles shall be retroreflectORIZED when used at night.
- STOP/SLOW paddles may be attached to a staff with a minimum length of 6' to the bottom of the sign.
- Any lights incorporated into the STOP or SLOW paddle faces shall only be as specifically described in Section 6E.03 Hand Signaling Devices in the TMUTCD.

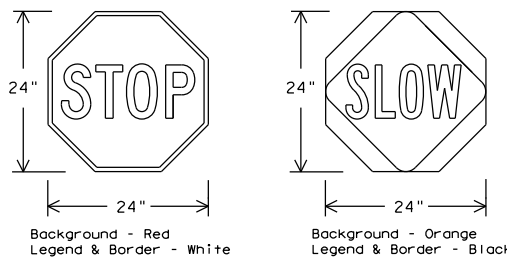

SHEETING REQUIREMENTS (WHEN USED AT NIGHT)		
USAGE	COLOR	SIGN FACE MATERIAL
BACKGROUND	RED	TYPE B OR C SHEETING
BACKGROUND	ORANGE	TYPE B _{FL} OR C _{FL} SHEETING
LEGEND & BORDER	WHITE	TYPE B OR C SHEETING
LEGEND & BORDER	BLACK	ACRYLIC NON-REFLECTIVE FILM

CONTRACTOR REQUIREMENTS FOR MAINTAINING PERMANENT SIGNS WITHIN THE PROJECT LIMITS

- Permanent signs are used to give notice of traffic laws or regulations, call attention to conditions that are potentially hazardous to traffic operations, show route designations, destinations, directions, distances, services, points of interest, and other geographical, recreational, specific service (LOGO), or cultural information. Drivers proceeding through a work zone need the same, if not better route guidance as normally installed on a roadway without construction.
- When permanent regulatory or warning signs conflict with work zone conditions, remove or cover the permanent signs until the permanent sign message matches the roadway condition. For details for covering large guide signs see the TS-CD standard.
- When existing permanent signs are moved and relocated due to construction purposes, they shall be visible to motorists at all times.
- If existing signs are to be relocated on their original supports, they shall be installed on crashworthy bases as shown on the SMD Standard sheets. The signs shall meet the required mounting heights shown on the BC Sheets or the SMD Standards. This work should be paid for under the appropriate pay item for relocating existing signs.
- If permanent signs are to be removed and relocated using temporary supports, the Contractor shall use crashworthy supports as shown on the BC standard sheets, TLRS standard sheets or the CWZTCD list. The signs shall meet the required mounting heights shown on the BC, or the SMD standard sheets during construction. This work should be paid for under the appropriate pay item for relocating existing signs.
- Any sign or traffic control device that is struck or damaged by the Contractor or his/her construction equipment shall be replaced as soon as possible by the Contractor to ensure proper guidance for the motorists. This will be subsidiary to Item 502.



BARRICADE AND CONSTRUCTION TEMPORARY SIGN NOTES

BC (4) - 21

FILE:	bc-21.dgn	DN:	TxDOT	CR:	TxDOT	OW:	TxDOT	CK:	TxDOT
© TxDOT	November 2002	CONT	SECT	JOB	HIGHWAY				
REVISIONS		1392	01	044, ETC.FM 1378, ETC.					
9-07	8-14	DIST	COUNTY		SHEET NO.				
7-13	5-21	DAL	COLLIN		81				

DATE: 10/29/2022 9:04:42 PM
FILE: c:\txdot\p_w_online\james.jgw\0483941\bc-21.dgn

DISCLAIMER: The use of this standard is governed by the "Texas Engineering Practice Act". No warranty of any kind is made by TxDOT for any purpose whatsoever. TxDOT assumes no responsibility for the conversion of this standard to other formats or for incorrect results or damages resulting from its use.

DATE: 10/29/2022 9:04:44 PM
 FILE: c:\txdot\pw_online\txdot5\james.i.gwe\d0483941\bc-21.dgn

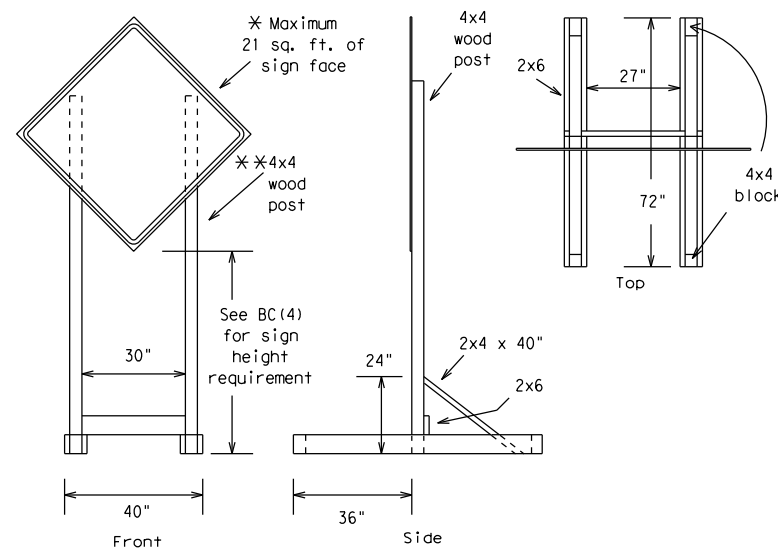

SKID MOUNTED WOOD SIGN SUPPORTS

* LONG/INTERMEDIATE TERM STATIONARY - PORTABLE SKID MOUNTED SIGN SUPPORTS

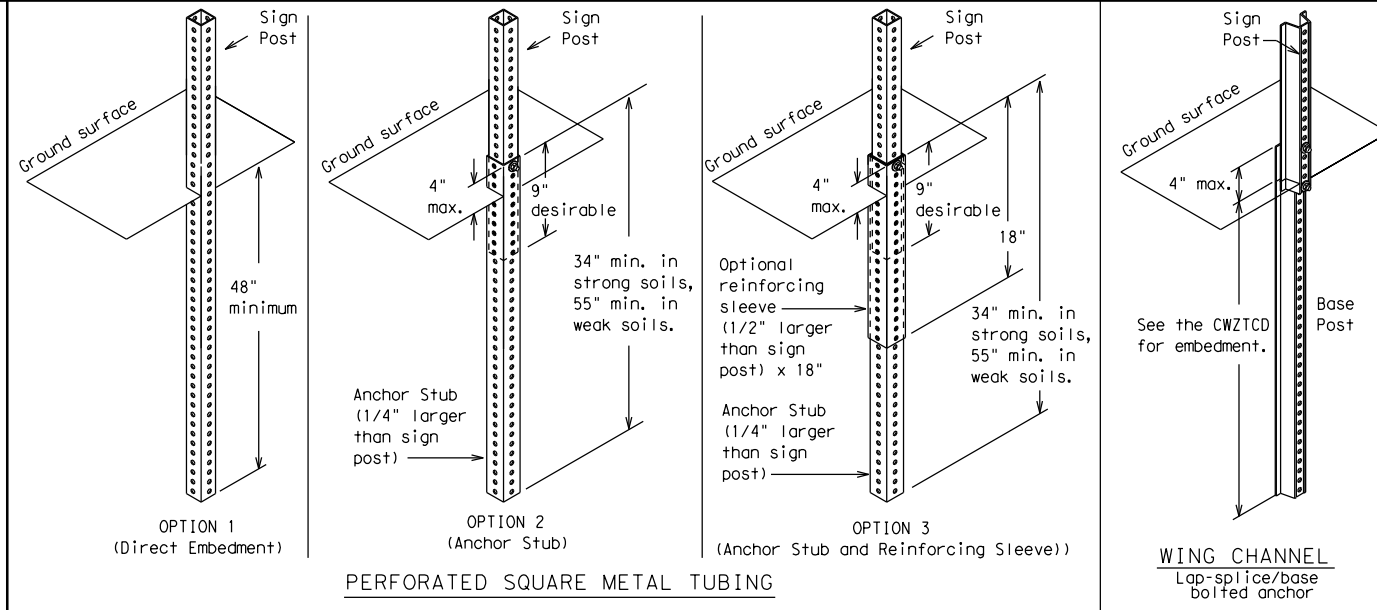
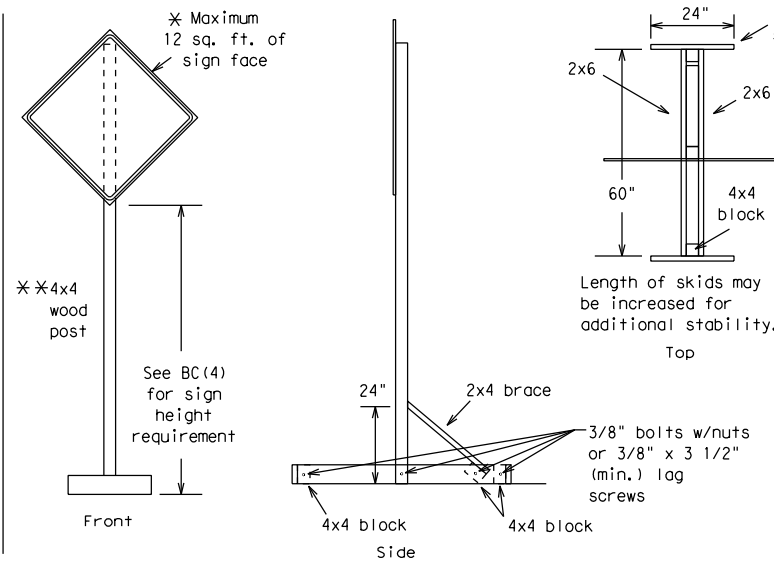

GROUND MOUNTED SIGN SUPPORTS

Refer to the CWZTCD and the manufacturer's installation procedure for each type sign support. The maximum sign square footage shall adhere to the manufacturer's recommendation. Two post installations can be used for larger signs.

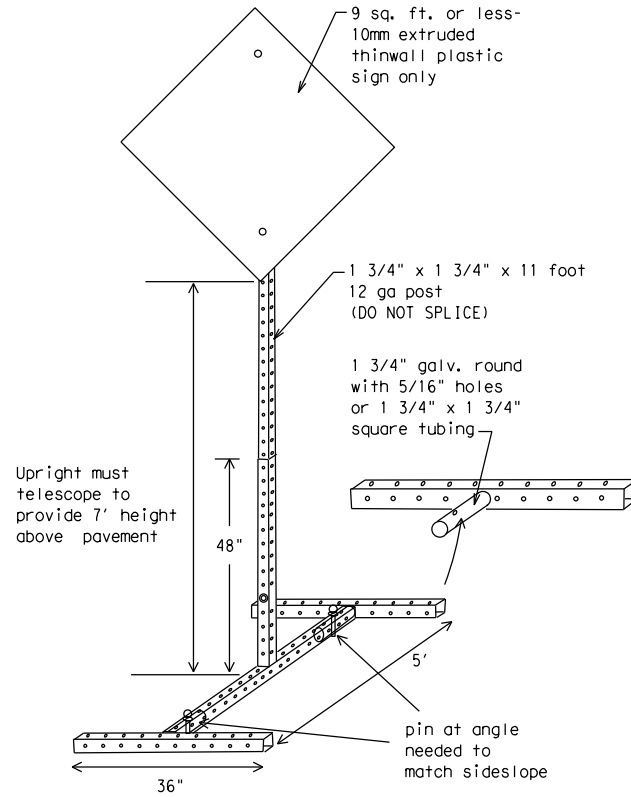

SKID MOUNTED PERFORATED SQUARE STEEL TUBING SIGN SUPPORTS

* LONG/INTERMEDIATE TERM STATIONARY - PORTABLE SKID MOUNTED SIGN SUPPORTS

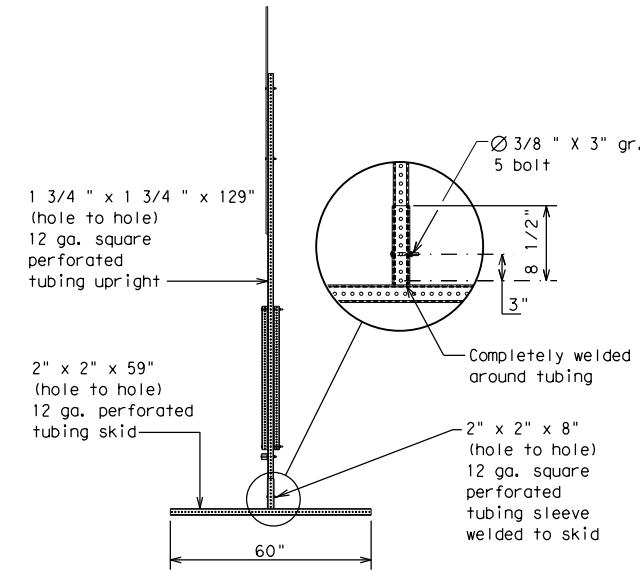
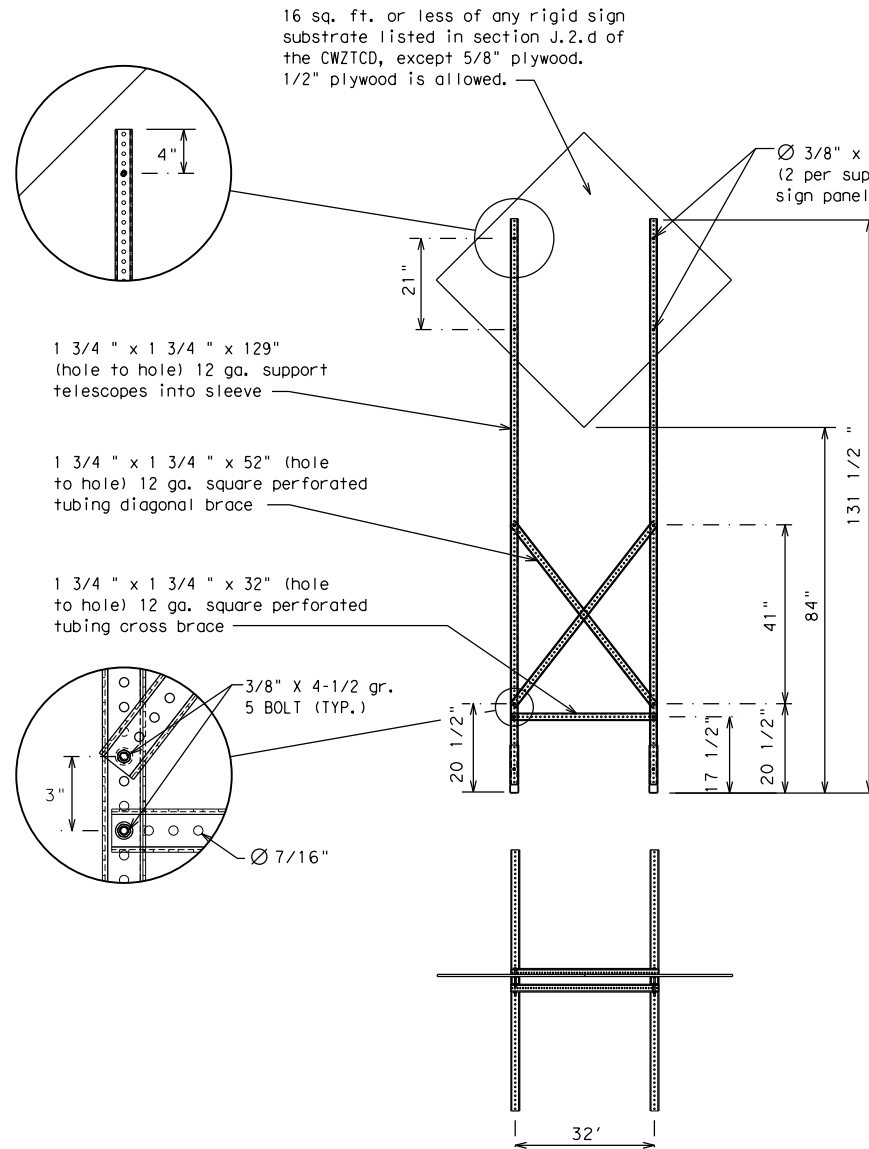

WEDGE ANCHORS

Both steel and plastic Wedge Anchor Systems as shown on the SMD Standard Sheets may be used as temporary sign supports for signs up to 10 square feet of sign face. They may be set in concrete or in sturdy soils if approved by the Engineer. (See web address for "Traffic Engineering Standard Sheets" on BC(1)).

OTHER DESIGNS

MORE DETAILS OF APPROVED LONG/INTERMEDIATE AND SHORT TERM SUPPORTS CAN BE FOUND ON THE CWZTCD LIST. SEE BC(1) FOR WEBSITE LOCATION.

GENERAL NOTES

1. Nails may be used in the assembly of wooden sign supports, but 3/8" bolts with nuts or 3/8" x 3 1/2" lag screws must be used on every joint for final connection.
2. No more than 2 sign posts shall be placed within a 7 ft. circle, except for specific materials noted on the CWZTCD List.
3. When project is completed, all sign supports and foundations shall be removed from the project site. This will be considered subsidiary to Item 502.

- * See BC(4) for definition of "Work Duration."
- ** Wood sign posts MUST be one piece. Splicing will NOT be allowed. Posts shall be painted white.
- See the CWZTCD for the type of sign substrate that can be used for each approved sign support.

SHEET 5 OF 12



BARRICADE AND CONSTRUCTION TYPICAL SIGN SUPPORT

BC(5) - 21

FILE:	bc-21.dgn	DN:	TxDOT	CK:	TxDOT	DW:	TxDOT	CR:	TxDOT
©TxDOT	November 2002	CONT	SECT	JOB	HIGHWAY				
REVISIONS		1392	01	044, ETC.FM 1378, ETC.					
9-07	8-14	DIST	COUNTY	SHEET NO.					
7-13	5-21	DAL	COLLIN	82					

WHEN NOT IN USE, REMOVE THE PCMS FROM THE RIGHT-OF-WAY OR PLACE THE PCMS BEHIND BARRIER OR GUARDRAIL WITH SIGN PANEL TURNED PARALLEL TO TRAFFIC

RECOMMENDED PHASES AND FORMATS FOR PCMS MESSAGES DURING ROADWORK ACTIVITIES

(The Engineer may approve other messages not specifically covered here.)

PORTABLE CHANGEABLE MESSAGE SIGNS

- The Engineer/Inspector shall approve all messages used on portable changeable message signs (PCMS).
- Messages on PCMS should contain no more than 8 words (about four to eight characters per word), not including simple words such as "TO," "FOR," "AT," etc.
- Messages should consist of a single phase, or two phases that alternate. Three-phase messages are not allowed. Each phase of the message should convey a single thought, and must be understood by itself.
- Use the word "EXIT" to refer to an exit ramp on a freeway; i.e., "EXIT CLOSED." Do not use the term "RAMP."
- Always use the route or interstate designation (IH, US, SH, FM) along with the number when referring to a roadway.
- When in use, the bottom of a stationary PCMS message panel should be a minimum 7 feet above the roadway, where possible.
- The message term "WEEKEND" should be used only if the work is to start on Saturday morning and end by Sunday evening at midnight. Actual days and hours of work should be displayed on the PCMS if work is to begin on Friday evening and/or continue into Monday morning.
- The Engineer/Inspector may select one of two options which are available for displaying a two-phase message on a PCMS. Each phase may be displayed for either four seconds each or for three seconds each.
- Do not "flash" messages or words included in a message. The message should be steady burn or continuous while displayed.
- Do not present redundant information on a two-phase message; i.e., keeping two lines of the message the same and changing the third line.
- Do not use the word "Danger" in message.
- Do not display the message "LANES SHIFT LEFT" or "LANES SHIFT RIGHT" on a PCMS. Drivers do not understand the message.
- Do not display messages that scroll horizontally or vertically across the face of the sign.
- The following table lists abbreviated words and two-word phrases that are acceptable for use on a PCMS. Both words in a phrase must be displayed together. Words or phrases not on this list should not be abbreviated, unless shown in the TMUTCD.
- PCMS character height should be at least 18 inches for trailer mounted units. They should be visible from at least 1/2 (.5) mile and the text should be legible from at least 600 feet at night and 800 feet in daylight. Truck mounted units must have a character height of 10 inches and must be legible from at least 400 feet.
- Each line of text should be centered on the message board rather than left or right justified.
- If disabled, the PCMS should default to an illegible display that will not alarm motorists and will only be used to alert workers that the PCMS has malfunctioned. A pattern such as a series of horizontal solid bars is appropriate.

Phase 1: Condition Lists

Road/Lane/Ramp Closure List

FREEWAY CLOSED X MILE
ROAD CLOSED AT SH XXX
ROAD CLSD AT FM XXXX
RIGHT X LANES CLOSED
CENTER LANE CLOSED
NIGHT LANE CLOSURES
VARIOUS LANES CLOSED
EXIT CLOSED
MALL DRIVEWAY CLOSED
XXXXXXXX BLVD CLOSED

Other Condition List

FRONTAGE ROAD CLOSED
SHOULDER CLOSED XXX FT
RIGHT LN CLOSED XXX FT
RIGHT X LANES OPEN
DAYTIME LANE CLOSURES
I-XX SOUTH EXIT CLOSED
EXIT XXX CLOSED X MILE
RIGHT LN TO BE CLOSED
X LANES CLOSED TUE - FRI
ROADWORK XXX FT
FLAGGER XXXX FT
RIGHT LN NARROWS XXXX FT
MERGING TRAFFIC XXXX FT
LOOSE GRAVEL XXXX FT
DETOUR X MILE
ROADWORK PAST SH XXXX
BUMP XXXX FT
TRAFFIC SIGNAL XXXX FT
ROAD REPAIRS XXXX FT
LANE NARROWS XXXX FT
TWO-WAY TRAFFIC XX MILE
CONST TRAFFIC XXX FT
UNEVEN LANES XXXX FT
ROUGH ROAD XXXX FT
ROADWORK NEXT FRI-SUN
US XXX EXIT X MILES
LANES SHIFT *

* LANES SHIFT in Phase 1 must be used with STAY IN LANE in Phase 2.

Phase 2: Possible Component Lists

Action to Take/Effect on Travel List

MERGE RIGHT
DETOUR NEXT X EXITS
USE EXIT XXX
STAY ON US XXX SOUTH
TRUCKS USE US XXX N
WATCH FOR TRUCKS
EXPECT DELAYS
REDUCE SPEED XXX FT
USE OTHER ROUTES
STAY IN LANE *
FORM X LINES RIGHT
USE XXXXX RD EXIT
USE EXIT I-XX NORTH
USE I-XX E TO I-XX N
WATCH FOR TRUCKS
EXPECT DELAYS
END SHOULDER USE
WATCH FOR WORKERS

Location List

AT FM XXXX
BEFORE RAILROAD CROSSING
NEXT X MILES
PAST US XXX EXIT
XXXXXXXX TO XXXXXXX
US XXX TO FM XXXX

Warning List

SPEED LIMIT XX MPH
MAXIMUM SPEED XX MPH
MINIMUM SPEED XX MPH
ADVISORY SPEED XX MPH
RIGHT LANE EXIT
USE CAUTION
DRIVE SAFELY
DRIVE WITH CARE

** Advance Notice List

TUE-FRI XX AM-X PM
APR XX-XX X PM-X AM
BEGINS MONDAY
BEGINS MAY XX
MAY X-X XX PM - XX AM
NEXT FRI-SUN
XX AM TO XX PM
NEXT TUE AUG XX
TONIGHT XX PM-XX AM

** See Application Guidelines Note 6.

APPLICATION GUIDELINES

- Only 1 or 2 phases are to be used on a PCMS.
- The 1st phase (or both) should be selected from the "Road/Lane/Ramp Closure List" and the "Other Condition List".
- A 2nd phase can be selected from the "Action to Take/Effect on Travel, Location, General Warning, or Advance Notice Phase Lists".
- A Location Phase is necessary only if a distance or location is not included in the first phase selected.
- If two PCMS are used in sequence, they must be separated by a minimum of 1000 ft. Each PCMS shall be limited to two phases, and should be understandable by themselves.
- For advance notice, when the current date is within seven days of the actual work date, calendar days should be replaced with days of the week. Advance notification should typically be for no more than one week prior to the work.

WORDING ALTERNATIVES

- The words RIGHT, LEFT and ALL can be interchanged as appropriate.
- Roadway designations IH, US, SH, FM and LP can be interchanged as appropriate.
- EAST, WEST, NORTH and SOUTH (or abbreviations E, W, N and S) can be interchanged as appropriate.
- Highway names and numbers replaced as appropriate.
- ROAD, HIGHWAY and FREEWAY can be interchanged as needed.
- AHEAD may be used instead of distances if necessary.
- FT and MI, MILE and MILES interchanged as appropriate.
- AT, BEFORE and PAST interchanged as needed.
- Distances or AHEAD can be eliminated from the message if a location phase is used.

PCMS SIGNS WITHIN THE R.O.W. SHALL BE BEHIND GUARDRAIL OR CONCRETE BARRIER OR SHALL HAVE A MINIMUM OF FOUR (4) PLASTIC DRUMS PLACED PERPENDICULAR TO TRAFFIC ON THE UPSTREAM SIDE OF THE PCMS, WHEN EXPOSED TO ONE DIRECTION OF TRAFFIC. WHEN EXPOSED TO TWO WAY TRAFFIC, THE FOUR DRUMS SHOULD BE PLACED WITH ONE DRUM AT EACH OF THE FOUR CORNERS OF THE UNIT.

FULL MATRIX PCMS SIGNS

- When Full Matrix PCMS signs are used, the character height and legibility/visibility requirements shall be maintained as listed in Note 15 under "PORTABLE CHANGEABLE MESSAGE SIGNS" above.
- When symbol signs, such as the "Flagger Symbol" (CW20-7) are represented graphically on the Full Matrix PCMS sign and, with the approval of the Engineer, it shall maintain the legibility/visibility requirement listed above.
- When symbol signs are represented graphically on the Full Matrix PCMS, they shall only supplement the use of the static sign represented, and shall not substitute for, or replace that sign.
- A full matrix PCMS may be used to simulate a flashing arrow board provided it meets the visibility, flash rate and dimming requirements on BC(7), for the same size arrow.

DISCLAIMER: The use of this standard is governed by the "Texas Engineering Practice Act". No warranty of any kind is made by TxDOT for any purpose whatsoever. TxDOT assumes no responsibility for the conversion of this standard to other formats or for incorrect results or damages resulting from its use.

DATE: 10/29/2022 9:04:46 PM
FILE: c:\txdot\p_w_online\txdot5\james.igwe\d0483941\bc-21.dgn

WORD OR PHRASE	ABBREVIATION	WORD OR PHRASE	ABBREVIATION
Access Road	ACCS RD	Major	MAJ
Alternate	ALT	Miles	MI
Avenue	AVE	Miles Per Hour	MPH
Best Route	BEST RTE	Minor	MNR
Boulevard	BLVD	Monday	MON
Bridge	BRDG	Normal	NORM
Cannot	CANT	North	N
Center	CTR	Northbound	(route) N
Construction Ahead	CONST AHD	Parking	PKING
CROSSING	XING	Road	RD
Detour Route	DETOUR RTE	Right Lane	RT LN
Do Not	DONT	Saturday	SAT
East	E	Service Road	SERV RD
Eastbound	(route) E	Shoulder	SHLDR
Emergency	EMER	Slippery	SLIP
Emergency Vehicle	EMER VEH	South	S
Entrance, Enter	ENT	Southbound	(route) S
Express Lane	EXP LN	Speed	SPD
Expressway	EXPWY	Street	ST
XXXX Feet	XXXX FT	Sunday	SUN
Fog Ahead	FOG AHD	Telephone	PHONE
Freeway	FRWY, FWY	Temporary	TEMP
Freeway Blocked	FWY BLKD	Thursday	THURS
Friday	FRI	To Downtown	TO DWNTN
Hazardous Driving	HAZ DRIVING	Traffic	TRAF
Hazardous Material	HAZMAT	Travelers	TRVLRS
High-Occupancy Vehicle	HOV	Tuesday	TUES
Hour(s)	HR, HRS	Time Minutes	TIME MIN
Information	INFO	Upper Level	UPR LEVEL
It Is	ITS	Vehicles (s)	VEH, VEHS
Junction	JCT	Warning	WARN
Left	LFT	Wednesday	WED
Left Lane	LFT LN	Weight Limit	WT LIMIT
Lane Closed	LN CLOSED	West	W
Lower Level	LWR LEVEL	Westbound	(route) W
Maintenance	MAINT	Wet Pavement	WET PVMT
		Will Not	WONT

Roadway designation # IH-number, US-number, SH-number, FM-number

<h3>BARRICADE AND CONSTRUCTION PORTABLE CHANGEABLE MESSAGE SIGN (PCMS)</h3>			
<h2>BC (6) - 21</h2>			
FILE:	bc-21.dgn	DN:	TxDOT
© TxDOT	November 2002	CONT:	1392
REVISIONS		SECT:	01
9-07	8-14	JOB:	044, ETC.FM 1378, ETC.
7-13	5-21	DIST:	COUNTY
		DAL:	COLLIN
		SHEET NO.:	83

DISCLAIMER: The use of this standard is governed by the "Texas Engineering Practice Act". No warranty of any kind is made by TxDOT for any purpose whatsoever. TxDOT assumes no responsibility for the conversion of this standard to other formats or for incorrect results or damages resulting from its use.

DATE: 10/29/2022 9:04:48 PM
 FILE: c:\txdot\pw_online\txdot5\james.igwe\0483941\bc-21.dgn

- Barrier Reflectors shall be pre-qualified, and conform to the color and reflectivity requirements of DMS-8600. A list of prequalified Barrier Reflectors can be found at the Material Producer List web address shown on BC(1).
- Color of Barrier Reflectors shall be as specified in the TMUTCD. The cost of the reflectors shall be considered subsidiary to Item 512.

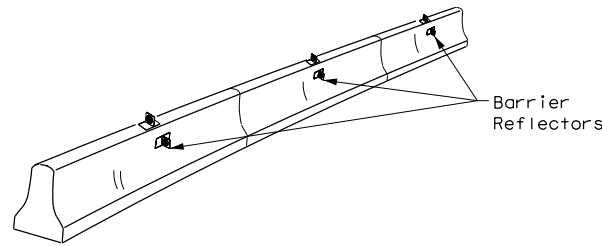

CONCRETE TRAFFIC BARRIER (CTB)

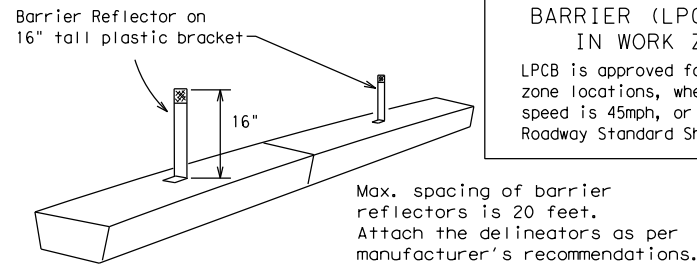

LOW PROFILE CONCRETE BARRIER (LPCB) USED IN WORK ZONES

LPCB is approved for use in work zone locations, where the posted speed is 45mph, or less. See Roadway Standard Sheet LPCB.

Max. spacing of barrier reflectors is 20 feet. Attach the delineators as per manufacturer's recommendations.

LOW PROFILE CONCRETE BARRIER (LPCB)

- Where traffic is on one side of the CTB, two (2) Barrier Reflectors shall be mounted in approximately the midsection of each section of CTB. An alternate mounting location is uniformly spaced at one end of each CTB. This will allow for attachment of a barrier grapple without damaging the reflector. The Barrier Reflector mounted on the side of the CTB shall be located directly below the reflector mounted on top of the barrier, as shown in the detail above.
- Where CTB separates two-way traffic, three barrier reflectors shall be mounted on each section of CTB. The reflector unit on top shall have two yellow reflective faces (Bi-Directional) while the reflectors on each side of the barrier shall have one yellow reflective face, as shown in the detail above.
- When CTB separates traffic traveling in the same direction, no barrier reflectors will be required on top of the CTB.
- Barrier Reflector units shall be yellow or white in color to match the edgeline being supplemented.
- Maximum spacing of Barrier Reflectors is forty (40) feet.
- Pavement markers or temporary flexible-reflective roadway marker tabs shall NOT be used as CTB delineation.
- Attachment of Barrier Reflectors to CTB shall be per manufacturer's recommendations.
- Missing or damaged Barrier Reflectors shall be replaced as directed by the Engineer.
- Single slope barriers shall be delineated as shown on the above detail.

See D & OM (VIA)

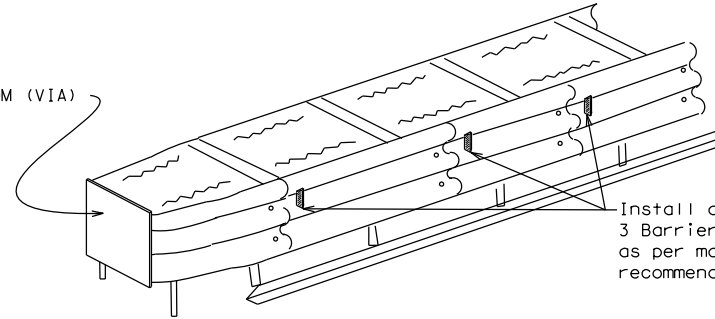

DELINEATION OF END TREATMENTS

END TREATMENTS FOR CTB'S USED IN WORK ZONES

End treatments used on CTB's in work zones shall meet the appropriate crashworthy standards as defined in the Manual for Assessing Safety Hardware (MASH). Refer to the CWZTCD List for approved end treatments and manufacturers.

BARRIER REFLECTORS FOR CONCRETE TRAFFIC BARRIER AND ATTENUATORS

WARNING LIGHTS

- Warning lights shall meet the requirements of the TMUTCD.
- Warning lights shall NOT be installed on barricades.
- Type A-Low Intensity Flashing Warning Lights are commonly used with drums. They are intended to warn of or mark a potentially hazardous area. Their use shall be as indicated on this sheet and/or other sheets of the plans by the designation "FL". The Type A Warning Lights shall not be used with signs manufactured with Type B_{FL} or C_{FL} Sheeting meeting the requirements of Departmental Material Specification DMS-8300.
- Type-C and Type D 360 degree Steady Burn Lights are intended to be used in a series for delineation to supplement other traffic control devices. Their use shall be as indicated on this sheet and/or other sheets of the plans by the designation "SB".
- The Engineer/Inspector or the plans shall specify the location and type of warning lights to be installed on the traffic control devices.
- When required by the Engineer, the Contractor shall furnish a copy of the warning lights certification. The warning light manufacturer will certify the warning lights meet the requirements of the latest ITE Purchase Specifications for Flashing and Steady-Burn Warning Lights.
- When used to delineate curves, Type-C and Type D Steady Burn Lights should only be placed on the outside of the curve, not the inside.
- The location of warning lights and warning reflectors on drums shall be as shown elsewhere in the plans.

WARNING LIGHTS MOUNTED ON PLASTIC DRUMS

- Type A flashing warning lights are intended to warn drivers that they are approaching or are in a potentially hazardous area.
- Type A random flashing warning lights are not intended for delineation and shall not be used in a series.
- A series of sequential flashing warning lights placed on channelizing devices to form a merging taper may be used for delineation. If used, the successive flashing of the sequential warning lights should occur from the beginning of the taper to the end of the merging taper in order to identify the desired vehicle path. The rate of flashing for each light shall be 65 flashes per minute, plus or minus 10 flashes.
- Type C and D steady-burn warning lights are intended to be used in a series to delineate the edge of the travel lane on detours, on lane changes, on lane closures, and on other similar conditions.
- Type A, Type C and Type D warning lights shall be installed at locations as detailed on other sheets in the plans.
- Warning lights shall not be installed on a drum that has a sign, chevron or vertical panel.
- The maximum spacing for warning lights on drums should be identical to the channelizing device spacing.

WARNING REFLECTORS MOUNTED ON PLASTIC DRUMS AS A SUBSTITUTE FOR TYPE C (STEADY BURN) WARNING LIGHTS

- A warning reflector or approved substitute may be mounted on a plastic drum as a substitute for a Type C, steady burn warning light at the discretion of the Contractor unless otherwise noted in the plans.
- The warning reflector shall be yellow in color and shall be manufactured using a sign substrate approved for use with plastic drums listed on the CWZTCD.
- The warning reflector shall have a minimum retroreflective surface area (one-side) of 30 square inches.
- Round reflectors shall be fully reflectorized, including the area where attached to the drum.
- Square substrates must have a minimum of 30 square inches of reflectorized sheeting. They do not have to be reflectorized where it attaches to the drum.
- The side of the warning reflector facing approaching traffic shall have sheeting meeting the color and retroreflectivity requirements for DMS 8300-Type B or Type C.
- When used near two-way traffic, both sides of the warning reflector shall be reflectorized.
- The warning reflector should be mounted on the side of the handle nearest approaching traffic.
- The maximum spacing for warning reflectors should be identical to the channelizing device spacing requirements.

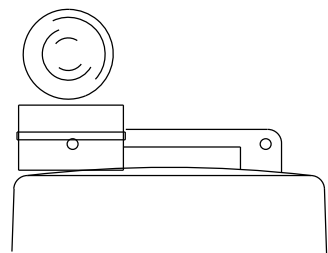

Type C Warning Light or approved substitute mounted on a drum adjacent to the travel way.

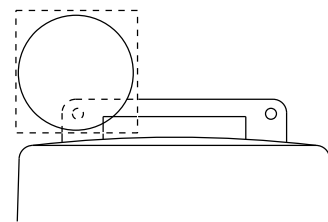

Warning reflector may be round or square. Must have a yellow reflective surface area of at least 30 square inches

Arrow Boards may be located behind channelizing devices in place for a shoulder taper or merging taper, otherwise they shall be delineated with four (4) channelizing devices placed perpendicular to traffic on the upstream side of traffic.

- The Flashing Arrow Board should be used for all lane closures on multi-lane roadways, or slow moving maintenance or construction activities on the travel lanes.
- Flashing Arrow Boards should not be used on two-lane, two-way roadways, detours, diversions or work on shoulders unless the "CAUTION" display (see detail below) is used.
- The Engineer/Inspector shall choose all appropriate signs, barricades and/or other traffic control devices that should be used in conjunction with the Flashing Arrow Board.
- The Flashing Arrow Board should be able to display the following symbols:

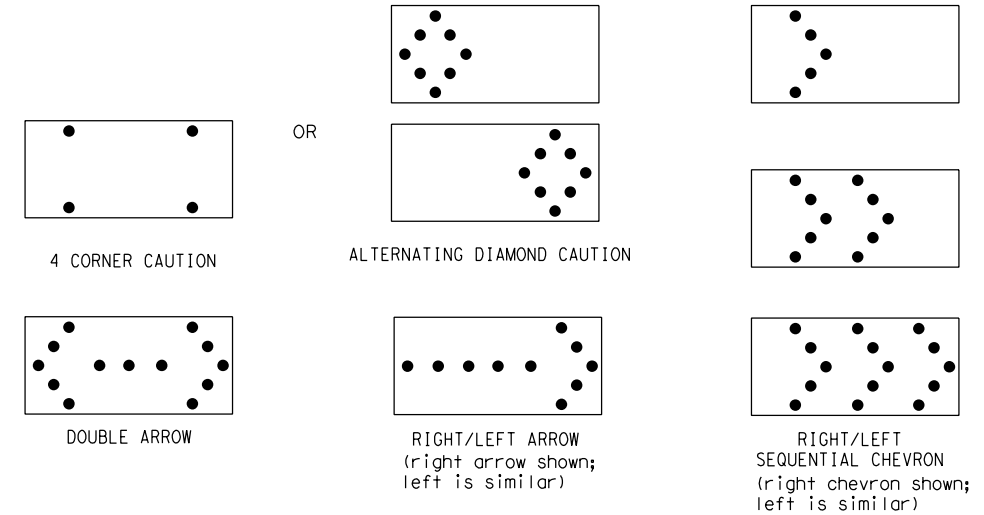

- The "CAUTION" display consists of four corner lamps flashing simultaneously, or the Alternating Diamond Caution mode as shown.
- The straight line caution display is NOT ALLOWED.
- The Flashing Arrow Board shall be capable of minimum 50 percent dimming from rated lamp voltage. The flashing rate of the lamps shall not be less than 25 nor more than 40 flashes per minute.
- Minimum lamp "on time" shall be approximately 50 percent for the flashing arrow and equal intervals of 25 percent for each sequential phase of the flashing chevron.
- The sequential arrow display is NOT ALLOWED.
- The flashing arrow display is the TxDOT standard; however, the sequential chevron display may be used during daylight operations.
- The Flashing Arrow Board shall be mounted on a vehicle, trailer or other suitable support.
- A Flashing Arrow Board SHALL NOT BE USED to laterally shift traffic.
- A full matrix PCMS may be used to simulate a Flashing Arrow Board provided it meets visibility, flash rate and dimming requirements on this sheet for the same size arrow.
- Minimum mounting height of trailer mounted Arrow Boards should be 7 feet from roadway to bottom of panel.

REQUIREMENTS			
TYPE	MINIMUM SIZE	MINIMUM NUMBER OF PANEL LAMPS	MINIMUM VISIBILITY DISTANCE
B	30 x 60	13	3/4 mile
C	48 x 96	15	1 mile

ATTENTION
 Flashing Arrow Boards shall be equipped with automatic dimming devices.

WHEN NOT IN USE, REMOVE THE ARROW BOARD FROM THE RIGHT-OF-WAY OR PLACE THE ARROW BOARD BEHIND CONCRETE TRAFFIC BARRIER OR GUARDRAIL.

FLASHING ARROW BOARDS

SHEET 7 OF 12

TRUCK-MOUNTED ATTENUATORS

- Truck-mounted attenuators (TMA) used on TxDOT facilities must meet the requirements outlined in the Manual for Assessing Safety Hardware (MASH).
- Refer to the CWZTCD for the requirements of Level 2 or Level 3 TMAs.
- Refer to the CWZTCD for a list of approved TMAs.
- TMAs are required on freeways unless otherwise noted in the plans.
- A TMA should be used anytime that it can be positioned 30 to 100 feet in advance of the area of crew exposure without adversely affecting the work performance.
- The only reason a TMA should not be required is when a work area is spread down the roadway and the work crew is an extended distance from the TMA.



BARRICADE AND CONSTRUCTION ARROW PANEL, REFLECTORS, WARNING LIGHTS & ATTENUATOR

BC (7) - 21

FILE:	bc-21.dgn	DN:	TxDOT	CR:	TxDOT	OW:	TxDOT	CK:	TxDOT
©TxDOT	November 2002	CONT	SECT	JOB	HIGHWAY				
REVISIONS		1392	01	044, ETC.FM 1378, ETC.					
9-07	8-14	DIST	COUNTY		SHEET NO.				
7-13	5-21	DAL	COLLIN		84				

DISCLAIMER: The use of this standard is governed by the "Texas Engineering Practice Act". No warranty of any kind is made by TxDOT for any purpose whatsoever. TxDOT assumes no responsibility for the conversion of this standard to other formats or for incorrect results or damages resulting from its use.

DATE: 10/29/2022 9:04:50 PM
 FILE: c:\t\dot\p_w_online\t\dot5\james.igwe\d0483941\bc-21.dgn

GENERAL NOTES

- For long term stationary work zones on freeways, drums shall be used as the primary channelizing device.
- For intermediate term stationary work zones on freeways, drums should be used as the primary channelizing device but may be replaced in tangent sections by vertical panels, or 42" two-piece cones. In tangent sections, one-piece cones may be used with the approval of the Engineer but only if personnel are present on the project at all times to maintain the cones in proper position and location.
- For short term stationary work zones on freeways, drums are the preferred channelizing device but may be replaced in tapers, transitions and tangent sections by vertical panels, two-piece cones or one-piece cones as approved by the Engineer.
- Drums and all related items shall comply with the requirements of the current version of the "Texas Manual on Uniform Traffic Control Devices" (TMUTCD) and the "Compliant Work Zone Traffic Control Devices List" (CWZTCD).
- Drums, bases, and related materials shall exhibit good workmanship and shall be free from objectionable marks or defects that would adversely affect their appearance or serviceability.
- The Contractor shall have a maximum of 24 hours to replace any plastic drums identified for replacement by the Engineer/Inspector. The replacement device must be an approved device.

GENERAL DESIGN REQUIREMENTS

Pre-qualified plastic drums shall meet the following requirements:

- Plastic drums shall be a two-piece design; the "body" of the drum shall be the top portion and the "base" shall be the bottom.
- The body and base shall lock together in such a manner that the body separates from the base when impacted by a vehicle traveling at a speed of 20 MPH or greater but prevents accidental separation due to normal handling and/or air turbulence created by passing vehicles.
- Plastic drums shall be constructed of lightweight flexible, and deformable materials. The Contractor shall NOT use metal drums or single piece plastic drums as channelization devices or sign supports.
- Drums shall present a profile that is a minimum of 18 inches in width at the 36 inch height when viewed from any direction. The height of drum unit (body installed on base) shall be a minimum of 36 inches and a maximum of 42 inches.
- The top of the drum shall have a built-in handle for easy pickup and shall be designed to drain water and not collect debris. The handle shall have a minimum of two widely spaced 9/16 inch diameter holes to allow attachment of a warning light, warning reflector unit or approved compliant sign.
- The exterior of the drum body shall have a minimum of four alternating orange and white retroreflective circumferential stripes not less than 4 inches nor greater than 8 inches in width. Any non-reflectORIZED space between any two adjacent stripes shall not exceed 2 inches in width.
- Bases shall have a maximum width of 36 inches, a maximum height of 4 inches, and a minimum of two footholds of sufficient size to allow base to be held down while separating the drum body from the base.
- Plastic drums shall be constructed of ultra-violet stabilized, orange, high-density polyethylene (HDPE) or other approved material.
- Drum body shall have a maximum unballasted weight of 11 lbs.
- Drum and base shall be marked with manufacturer's name and model number.

RETROREFLECTIVE SHEETING

- The stripes used on drums shall be constructed of sheeting meeting the color and retroreflectivity requirements of Departmental Materials Specification DMS-8300, "Sign Face Materials." Type A or Type B reflective sheeting shall be supplied unless otherwise specified in the plans.
- The sheeting shall be suitable for use on and shall adhere to the drum surface such that, upon vehicular impact, the sheeting shall remain adhered in-place and exhibit no delaminating, cracking, or loss of retroreflectivity other than that loss due to abrasion of the sheeting surface.

BALLAST

- Unballasted bases shall be large enough to hold up to 50 lbs. of sand. This base, when filled with the ballast material, should weigh between 35 lbs (minimum) and 50 lbs (maximum). The ballast may be sand in one to three sandbags separate from the base, sand in a sand-filled plastic base, or other ballasting devices as approved by the Engineer. Stacking of sandbags will be allowed, however height of sandbags above pavement surface may not exceed 12 inches.
- Bases with built-in ballast shall weigh between 40 lbs. and 50 lbs. Built-in ballast can be constructed of an integral crumb rubber base or a solid rubber base.
- Recycled truck tire sidewalls may be used for ballast on drums approved for this type of ballast on the CWZTCD list.
- The ballast shall not be heavy objects, water, or any material that would become hazardous to motorists, pedestrians, or workers when the drum is struck by a vehicle.
- When used in regions susceptible to freezing, drums shall have drainage holes in the bottoms so that water will not collect and freeze becoming a hazard when struck by a vehicle.
- Ballast shall not be placed on top of drums.
- Adhesives may be used to secure base of drums to pavement.

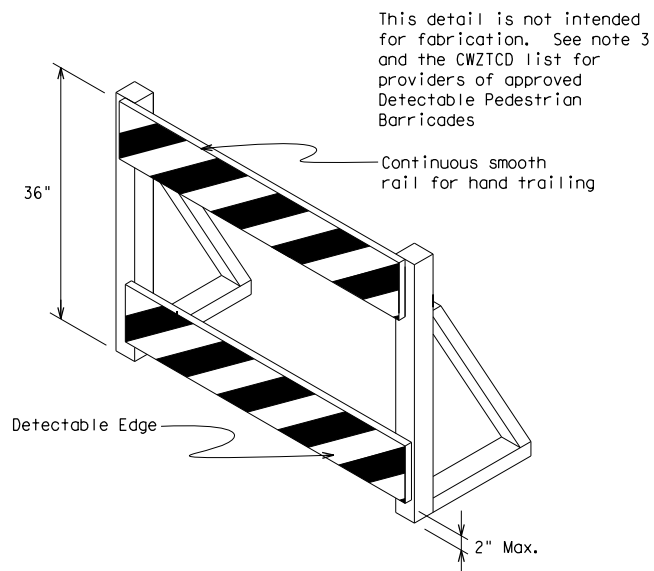
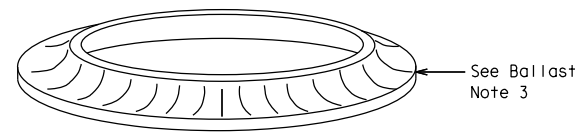
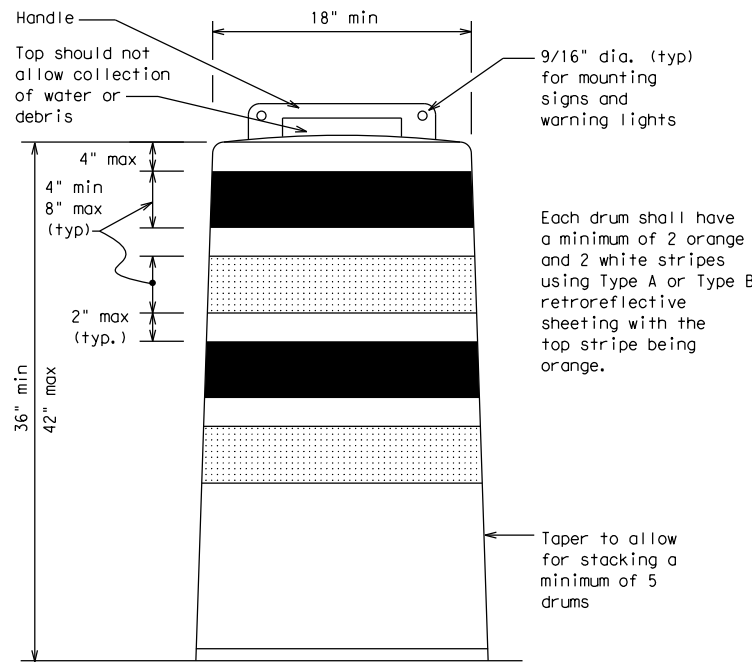

DETECTABLE PEDESTRIAN BARRICADES

- When existing pedestrian facilities are disrupted, closed, or relocated in a TTC zone, the temporary facilities shall be detectable and include accessibility features consistent with the features present in the existing pedestrian facility. Refer to WZ(BTS-2) for Pedestrian Control requirements for Sidewalk Diversions, Sidewalk Detours and Crosswalk Closures.
- Where pedestrians with visual disabilities normally use the closed sidewalk, a Detectable Pedestrian Barricade shall be placed across the full width of the closed sidewalk instead of a Type 3 Barricade.
- Detectable pedestrian barricades similar to the one pictured above, longitudinal channelizing devices, some concrete barriers, and wood or chain link fencing with a continuous detectable edging can satisfactorily delineate a pedestrian path.
- Tape, rope, or plastic chain strung between devices are not detectable, do not comply with the design standards in the "Americans with Disabilities Act Accessibility Guidelines (ADAAG)" and should not be used as a control for pedestrian movements.
- Warning lights shall not be attached to detectable pedestrian barricades.
- Detectable pedestrian barricades should use 8" nominal barricade rails as shown on BC(10) provided that the top rail provides a smooth continuous rail suitable for hand trailing with no splinters, burrs, or sharp edges.

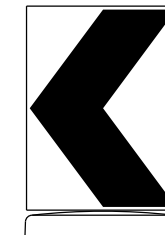

18" x 24" Sign
 (Maximum Sign Dimension)
 Chevron CW1-8, Opposing Traffic Lane
 Divider, Driveway sign D70a, Keep Right
 R4 series or other signs as approved
 by Engineer

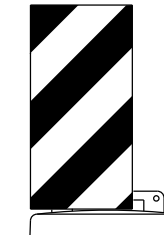

12" x 24"
 Vertical Panel
 mount with diagonals
 sloping down towards
 travel way

Plywood, Aluminum or Metal sign
 substrates shall NOT be used on
 plastic drums

SIGNS, CHEVRONS, AND VERTICAL PANELS MOUNTED ON PLASTIC DRUMS

- Signs used on plastic drums shall be manufactured using substrates listed on the CWZTCD.
- Chevrons and other work zone signs with an orange background shall be manufactured with Type B_{FL} or Type C_{FL} Orange sheeting meeting the color and retroreflectivity requirements of DMS-8300, "Sign Face Material," unless otherwise specified in the plans.
- Vertical Panels shall be manufactured with orange and white sheeting meeting the requirements of DMS-8300 Type A or Type B. Diagonal stripes on Vertical Panels shall slope down toward the intended traveled lane.
- Other sign messages (text or symbolic) may be used as approved by the Engineer. Sign dimensions shall not exceed 18 inches in width or 24 inches in height, except for the R9 series signs discussed in note 8 below.
- Signs shall be installed using a 1/2 inch bolt (nominal) and nut, two washers, and one locking washer for each connection.
- Mounting bolts and nuts shall be fully engaged and adequately torqued. Bolts should not extend more than 1/2 inch beyond nuts.
- Chevrons may be placed on drums on the outside of curves, on merging tapers or on shifting tapers. When used in these locations, they may be placed on every drum or spaced not more than on every third drum. A minimum of three (3) should be used at each location called for in the plans.
- R9-9, R9-10, R9-11 and R9-11a Sidewalk Closed signs which are 24 inches wide may be mounted on plastic drums, with approval of the Engineer.

SHEET 8 OF 12



BARRICADE AND CONSTRUCTION CHANNELIZING DEVICES

BC (8) - 21

FILE:	bc-21.dgn	DN:	TxDOT	CK:	TxDOT	DW:	TxDOT	CR:	TxDOT
© TxDOT	November 2002	CONT	SECT	JOB	HIGHWAY				
REVISIONS		1392	01	044, ETC.FM 1378, ETC.					
4-03	8-14	DIST		COUNTY	SHEET NO.				
9-07	5-21	DAL		COLLIN	85				
7-13									