

GUIDELINES
for
**PROTECTING AQUATIC HABITAT
AND SALMON FISHERIES**
for
COUNTY ROAD MAINTENANCE

DECEMBER 2004
Update in 2007 to Chapters 2 & 10

FishNet 4C
Marin County Public Works
P.O. Box 4186 San Rafael, CA 94913

Developed by:

Prunuske Chatham, Inc.
400 Morris St., Suite G
Sebastopol, CA 95472

MFG, Inc.
180 Howard St., Suite 200
San Francisco, CA 94105

Pacific Watershed Associates
P.O. Box 4433
Arcata, CA 95518

ACKNOWLEDGEMENTS

Development of these guidelines has been a goal of the FishNet 4C Program from the outset, although we never intended to reinvent the wheel. When this project got underway, San Mateo and Santa Cruz Counties were already developing maintenance manuals and training crews on-the-ground to implement BMPs for fisheries protection: San Mateo County Maintenance Standards, February 2001; and Santa Cruz County Erosion Control Manual, 2001. This manual builds on that work to develop a comprehensive set of guidelines for aquatic habitat protection that can be used by Public Works, Parks and Open Space departments in our FishNet Counties.

These guidelines incorporate materials derived from a number of very good existing manuals, including:

- Road Maintenance Manual, Oregon Department of Transportation (2001).
- A Water Quality and Stream Habitat Protection Manual for County Road Maintenance in Northwestern California Watersheds, Northern Five Counties Salmon Conservation Group (June 2002).
- Regional Road Maintenance Endangered Species Act Program Guidelines, developed for the counties in Washington State (January 2002).
- Highway Design Manual, Caltrans (Sept. 2001).
- Regional Water Quality Control Boards' erosion control manuals.
- California Salmonid Stream Habitat Restoration Manual, California Department of Fish and Game; Flosi et al.(2002).
- Flood Control Facility Maintenance Manual, Bay Area Stormwater Management Agencies Association (BASMAA) (June 2000).

The FishNet 4C Program acknowledges the use of these materials and would like to thank the agencies and individuals for their previous efforts in this field and for their willingness to share their materials.

Additional acknowledgement goes to MFG, inc., for their good work writing the core and bulk of the manual, to Danny Hagans (Pacific Watershed Associates) for the writing of a new Road Treatment and Design chapter, and to Harold Appleton (Prunuske Chatham) for his dedicated work on the Appendix A BMPs and drawings.

A special thanks goes to the Northern Five Counties group, for generously sharing the introductory chapters on permitting, watersheds and fisheries habitat with their neighboring counties to the south.





TABLE OF CONTENTS

CHAPTER 1: Overview	1-1
CHAPTER 2: Regulations and Permits	2-1
2.1 Federal Laws and Regulations	2-3
2.2 State Laws and Regulations	2-7
2.3 Local Government Laws and Regulations	2-10
2.4 Permits.....	2-12
2.5 Regulatory Agency Contacts for FishNet 4C.....	2-23
2.6 Permitting References	2-24
CHAPTER 3: Working In The Watershed	3-1
CHAPTER 4: Stream Habitat And Salmon Fisheries	4-1
CHAPTER 5: Road Maintenance	5-1
5.1 Road Treatment and Design Principle.....	5-3
5.2 Paved Road Surfaces	5-23
5.3 Unpaved Road Surfaces	5-27
5.4 Shoulder Maintenance	5-33
5.5 Roadside Ditches	5-37
5.6 Drainage Systems	5-43
5.7 Street Surface Cleaning	5-47
5.8 Concrete Work	5-49
5.9 Snow and Ice	5-51
CHAPTER 6: Working In Or Near Stream Channels	6-1
6.1 General Principles	6-3
6.2 Culvert Cleaning, Repair and Replacement	6-9
6.3 Woody Debris.....	6-17
6.4 Stream Bank Stabilization	6-19
6.5 Dewatering	6-23
6.6 Low Water Crossing Installation and Maintenance	6-29
CHAPTER 7: Sediment Control	7-1
7.1 Erosion Control –General Principles.....	7-3
7.2 Minor Slide Repair	7-9
7.3 Spoils Handling and Disposal	7-15
CHAPTER 8: Vegetation Management	8-1
CHAPTER 9: Maintenance Facilities	9-1
9.1 Building and Grounds Maintenance.....	9-3

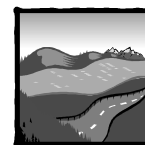

9.2 Vehicle and Equipment Maintenance.....	9-7
9.3 Oil-Water Separator Maintenance.....	9-11
9.4 Waste Handling, Storage and Disposal	9-13
9.5 Hazardous Materials.....	9-15
9.6 Spill Prevention and Control	9-19

CHAPTER 10: Emergency Work..... 10-1

10.1 Emergency Response	10-3
10.2 Emergency Slide and Washout Repair.....	10-9
10.3 Accident Clean up	10-13
10.4 Emergency Utility Repairs	10-15

Appendix A - BMP Toolbox

Table of Contents	A-1
Road Drainage BMPs.....	A-5
Culvert BMPs	A-27
Erosion Control BMPs	A-51
Sediment Management BMPs.....	A-91
Water Management BMPs	A-145
Streambank Protection –Biotechnical BMPs	A-183
Streambank Protection – Hardscape BMPs.....	A-217
Planning and Prevention BMPs.....	A-227

Appendix B- Glossary B-1

Acronyms	B-3
Definition of Terms	B-5

Appendix C- Technical References..... C-1

1. Culvert Criteria for Fish Passage

California Salmonid Stream Habitat Restoration Manual. Appendix IX-A. CDFG Flosi et al; 2002.

2. Guidelines for Salmonid Passage at Stream Crossings- NOAA Fisheries

California Salmonid Stream Habitat Restoration Manual. Appendix IX-B. CDFG Flosi et al; 2002.

3. NOAA Fisheries Water Drafting Specifications

Southwest Region, August 2001

4. CDFG Guidelines for Temporary Water Drafting

CDFG Timber and Resources Program; DRAFT 2001

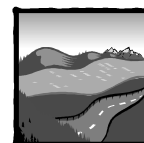

5. Dust Palliative Application Guidelines

San Francisco Regional Water Quality Control Board; Erosion and Sediment Control Manual
2002.



CHAPTER 1

INTRODUCTION

WHAT IS FISHNET 4C?

In response to the Federal Endangered Species Act (ESA) listings of the coho salmon (1996) and steelhead trout (1997) on the Central California coast, County Supervisors from six counties took a proactive stand for fisheries protection, forming FishNet 4C – the Fishery Network of the Central California Coastal Counties. The FishNet 4C region is defined by the Central California Coast Evolutionarily Significant Unit (CCCESU) for coho salmon and steelhead trout, and runs along the coast from the Russian River Basin in Mendocino south to the Big Sur Coast. It includes the counties of Mendocino (Russian River basin only), Sonoma, Marin, San Mateo, Santa Cruz and Monterey. Members of FishNet 4C include County Supervisors, County Planning, Public Works, Parks and Open Space staff, local, state and federal agencies, and other key partners within our counties, such as cities, Resource Conservation Districts (RCDs) and water agencies.

The Goal of FishNet 4C is: *To facilitate effective local actions that will maintain and improve our region's water quality and riparian habitat, provide increased assistance and education for local government and the private sector, and encourage cooperation and coordination between all levels of regulatory responsibility for fishery restoration.*

One of FishNet's first projects was to bring in UC Berkeley to evaluate whether county policies and programs were adequate to protect aquatic habitat and salmon fisheries. The study, or "environmental report card"- Effects of County Land Use Policies and Management Practices on Anadromous Salmonids and Their Habitats (Harris, 2001), highly recommended that our counties develop written guidelines for public works, parks and open space departments, on how to best protect the aquatic environment while conducting their daily work on our roads and drainage systems. FishNet members formed an Operations and Maintenance Sub-Committee, and through this committee, with much dedication and effort from our members, these guidelines were developed. The development of the manual is just the first step, to be followed with adoption of the guidelines by County Boards of Supervisors and then intensive trainings for County roads crews and managers, in partnership with the FishNet Program.

INTENTION OF THE GUIDELINES

The primary responsibility of our county transportation departments and road crews is to keep the roads open and safe for the traveling public. Providing for all the services the public asks for and ensuring public safety, requires sound judgment on the part of road engineers, managers, and crews in the field. It is the intention that these guidelines be adopted and implemented in all situations where feasible, allowing for both good judgment and discretion on the part of roads superintendents and field crews.

In addition, our Counties' Departments of Transportation need to operate within the realities of annual budgets and long term capital improvement budgets. This is particularly important now, given the fiscal crisis the State of California is in and the subsequent budget shortfalls experienced at the county level. Working with the FishNet Operations and Maintenance Sub-Committee, we have committed our crews to protecting the environment and implementing the guidelines to the highest degree possible, given the reality of each county's situation. In fact,

many of our counties are already implementing many of the best management practices outlined in the manual already. The training program that Fishnet implements will also go a long way toward applying what is learned here in the manual to situations on the ground. All efforts combined will help us to take a giant step forward to protect our streams and anadromous salmon populations.

WHAT IS IN THIS MANUAL?

The key focus of this manual is on implementing best management practices related to protecting water quality, aquatic habitat and salmonid fisheries. The guidelines outlined in the manual address most routine and emergency road related maintenance activities undertaken by County Departments of Public Works, Parks, and Open Space Districts, and they also address common facilities such as spoils storage sites and maintenance yards. The guidelines apply to in-house county activities related to county facilities, not to private development.

Overall, the manual addresses issues related to routine maintenance. There are, however, a limited number of instances where we have expanded the scope of the manual, based on agency comments, to include more project related activities. These include road redesign, culvert replacement, and streambank stabilization projects. We felt it was important to include these road related projects, because they are so important in protecting salmonid habitat.

In *Chapter 2, Regulations and Permits*, we'll introduce you to existing laws and regulations that protect our rivers and streams, to the agencies responsible for implementing these laws, and to agency permits needed for each type of activity. This manual does not supersede or replace any other agency's regulations or policies.

Chapter 3, Working in the Watershed, lays the groundwork for understanding the basic science of watershed protection and why this is so important to protecting aquatic habitat.

Chapter 4, Stream Habitat and Salmon Fisheries, outlines the basics of salmonid life cycles and their needs in the aquatic environment. This chapter is of particular importance in training staff on why Best Management Practices (BMPs) are needed and how they can be most effective in protecting our rivers and aquatic wildlife.

Chapters 5-10 make up the core of the manual, addressing specific activities that county departments routinely undertake. In these chapters, the manual summarizes areas of environmental concern for each activity and provides mitigations and recommended BMPs to address each concern.

Lastly, the Appendices serve as technical references:

- Appendix A- BMP specs and illustrations
- Appendix B- Glossary- Agency abbreviations and Definitions of Terms, and
- Appendix C- Technical papers including: Guidelines for Fish Passage (NOAA and DFG), Water Drafting Specifications (NOAA and DFG), and Dust Palliative Application.

THIS MANUAL DOES *NOT* APPLY TO:

- In-channel flood control activities
- Non-road-related stream bank stabilization
- Design or construction of new facilities, (except for culvert replacement)
- Major expansion of existing roads and facilities
- Private development

WHO IS THIS MANUAL FOR?

The guidelines are designed for Public Works, Parks, and Open Space Districts to implement when working on County road related projects and facilities. The materials in all chapters are aimed to assist managers and road supervisors to develop and implement trainings for field crews and engineers, in partnership with the FishNet 4C program. Most importantly, the manual is developed to assist in the recovery of salmonid species within the Central California Coast region. We at FishNet hope our counties will contribute to both State and Federal Salmonid Recovery Planning efforts by adopting and implementing the practices laid out in the manual.

HOW CAN YOU USE THESE GUIDELINES?

The work of county road maintenance departments routinely affects the environment, and in particular, can affect waterways that cross or run close to county roads. This manual provides a basic framework of guidelines to maintain and repair roads while also preserving and restoring crucial natural waterways and fish habitats. By adopting and using this manual, you can substantially reduce the impacts that county road maintenance activities have on the environment. In particular, you will help protect salmon fisheries and water quality and meet current and future Total Maximum Daily Load (TMDL) goals for rivers and their drainage basins. As well, the manual will assist county maintenance departments meet requirements to protect salmonid habitat, as outlined in the Federal ESA 4(d) Rule and California State ESA listings to protect coho and chinook salmon and steelhead trout in the Central California Coast ESU (Evolutionary Significant Unit).

The core principles to remember during road maintenance are:

- ✓ Minimize overall impact on the environment.
- ✓ Avoid discharging sediment or other pollutants into waterways such as creeks, wetlands and storm drains.
- ✓ Maintain natural drainage patterns and provide for fish passage.
- ✓ Retain vegetation (or replace invasive plants with native vegetation).

GOALS AND OBJECTIVES OF THE MANUAL

Meeting Federal and State Endangered Species Act Requirements

The FishNet 4C Counties within the CCCESU are under Federal and State ESA requirements to protect salmonid species, both as land use permitters and land and facilities managers. Under the Federal ESA, coho salmon and steelhead trout are listed as *threatened*, and are protected by specifics outlined in Section 4(d) of the Federal ESA, more commonly known as the 4(d) Rule. Under the California State Endangered Species Act (CESA), coho salmon are listed as *endangered* (August 2002), from Punta Gorda south to the San Francisco Bay. From San Francisco south to Aptos Creek in Santa Cruz, coho salmon have been listed as *endangered* since 1997. From Punta Gorda north to the Oregon border, coho salmon are listed as *threatened* under CESA (August 2002).

County Contribution to Recovery Planning for Salmonid Species

The California State Department of Fish and Game has prepared a State Recovery Plan for coho salmon, completed and adopted in June 2004. NOAA Fisheries is in the process of preparing a Federal Recovery Plan for all species of listed salmonids (chinook, coho and steelhead). Beyond complying with the rules, implementation of the principles laid out in these guidelines will assist our counties in contributing to both State and Federal Recovery Planning efforts and will assist in the physical recovery of these salmonid species within our region.

Meeting Clean Water Act and NPDES Phase II Requirements

One of the principle goals of the FishNet 4C program is to integrate Clean Water Act and Endangered Species Act programs where possible. The FishNet Program has developed these guidelines to minimize impacts to aquatic habitat and water quality. These procedures are intended to contribute to each county's efforts to meet regulations under Phase II of the National Pollutant Discharge Elimination System (NPDES), promulgated by the Regional Water Quality Control Boards in the FishNet 4C region. NPDES Phase II provides for permits for discharges of storm water from: (a) construction activity >1 acre of soil disturbance; (b) certain industrial activities including mining and vehicle maintenance (such as County Road Maintenance Yards); and c) municipal facilities, including roads. The Phase II Stormwater permit requirements apply to water quality issues in areas of the watershed that are served by a municipal storm sewer system. NPDES Phase II compliance includes implementation of best management practices, such as those published in these guidelines, as well as the achievement of measurable goals in the following areas: 1) public education, 2) public participation/involvement, 3) illicit discharge detection and elimination, 4) construction site runoff control, 5) post-construction runoff control, and 6) pollution prevention/good housekeeping.

**CHAPTER 2
REGULATIONS AND PERMITS**

2.1 Federal Laws and Regulations 2-3

2.2 State Laws and Regulations..... 2-7

2.3 Local Government Laws and Regulations 2-10

2.4 Permits 2-12

2.5 Regulatory Agency Contacts for FishNet 4C..... 2-23

2.6 Permitting References 2-24

2.1 FEDERAL LAWS AND REGULATIONS

Laws and ordinances are acts of legislation passed by legislative branches of government such as the US Congress, the State Legislature, County Boards of Supervisors and City Councils. Regulations are developed by the executive branch's agencies assigned to administering the implementation of the laws. Although distinct, the terms "laws" and "regulations" are often combined to describe the rules that must be followed to avoid breaking the law.

FEDERAL ENDANGERED SPECIES ACT (ESA)

The Federal ESA provides a program for the conservation of endangered and threatened species and provides for the conservation of designated critical habitat of listed species. Federal agencies shall ensure that actions or projects are not likely to jeopardize the continued existence of listed species and also ensure that no destruction or adverse modification of critical habitat for the listed species occurs.

- **ESA Section 4** – Determination of Endangered, Threatened, and Species of Concern status and designation of critical habitat. Section 4 requires development of a recovery plan for declining populations. A species is considered *endangered* when it is in danger of extinction throughout all or a significant portion of its range and *threatened* when it is likely to become endangered within the foreseeable future throughout all or a significant portion of its range. On the Central California Coast, Coho salmon are listed under the Federal ESA as *endangered*, while Chinook salmon and Steelhead trout are listed as *threatened*.
- **ESA Section 4(d)** - Requires NOAA Fisheries to issue regulations deemed "necessary and advisable to provide for the conservation of the species". A 4(d) Rule applies to species listed as *threatened*, and outlines what actions are likely to take a specific listed species. Section 4(d) also allows for fines upon violation and third party lawsuits. On the Central California Coast, Steelhead trout have 4(d) Rule regulations. The following activities listed in Table 2-1 are enumerated in the 4(d) Rule for Central California Coast steelhead (May 18 2000) as those "most likely to cause harm and thereby violate the 4(d) Rule". NOAA Fisheries ESA enforcement focuses on these categories of activities.
- **ESA Section 7** – Interagency Cooperation Agreements. Requires federal agencies, in consultation with NOAA Fisheries and USFWS, to ensure that protections of the species are built into projects and requires a Biological Assessment (BA) if one or more listed species may be present in the project action area. This section applies to federally-funded and federally-permitted projects or Corps projects such as flood control or water supply structures. These types of projects have a "federal nexus", and thus warrant a Section 7 Agreement.
- ◆ **ESA Section 9** – Provides guidance regarding activities determined to result in "take". Application of uniform regulations when a species is listed as endangered. Defines "**take**" of a species: "to harass, harm, pursue, hunt, shoot, wound, kill, trap, capture, or collect, or to attempt to engage in any such conduct" with respect to federally listed species under ESA. "**Harass**" includes annoying a protected species to such an extent as to significantly disrupt normal behavior patterns such as breeding, feeding, or sheltering. "**Harm**" is defined as an act that actually kills or injures a protected species and can arise from significant modification or degradation of habitat, which impairs essential behavioral patterns, including breeding, spawning, rearing, migrating, feeding, or sheltering.
- **ESA Section 10**– Exceptions - applies to those projects with no federal involvement. Provides guidance on the issuance of "incidental take" permits when potential "take" of listed species, which

requires development of a satisfactory Habitat Conservation Plan (HCP) for the species. Also deals with direct take associated with authorized monitoring and research activities.

Table 2-1. Activities Determined to Cause Take or Harm to Listed Species under Section 4(d) of the Federal Endangered Species Act¹

A. Constructing or maintaining structures like culverts, berms, or dams that eliminate or impede a species' ability to migrate or gain access to habitat.
B. Discharging pollutants such as oil, toxic chemicals, radioactivity, carcinogens, mutagens, teratogens, or organic nutrient-laden water (including sewage water) into a listed species' habitat.
C. Removing, poisoning or contaminating plants, fish, wildlife, or other biota that the listed species requires for feeding, sheltering or other essential behavioral patterns.
D. Removing or altering rocks, soil, gravel, vegetation or other physical structures that are essential to the integrity and function of a listed species' habitat.
E. Removing water or otherwise altering streamflow in a manner that significantly impairs spawning, migration, feeding or other essential behavioral patterns.
F. Releasing non-indigenous or artificially propagated species into a listed species' habitat or into areas where they might gain access to that habitat.
G. Constructing or operating dams or water diversion structures with inadequate fish screens or passage facilities.
H. Constructing, maintaining or using inadequate bridges, roads or trails on stream banks or unstable hill slopes adjacent to or above a species' habitat
I. Conducting timber harvest, grazing, mining, earth-moving, or other operations that substantially increase the amount of sediment going into streams
J. Conducting land-use activities that may disturb soil and increase sediment delivery to streams, such as logging, grazing, farming, and road construction- in riparian areas and areas susceptible to mass wasting and surface erosion.
K. Illegal fishing. Harvest that violates fishing regulations is a top enforcement concern.
L. Various streambed disturbances may trample eggs or trap adult fish preparing to spawn. The disturbance could be mechanical disruption caused by construction push-up dams. Removing gravel, mining or other work in a stream channel. It may also take the form of egg trampling or smothering by livestock in the streambed or by vehicles or equipment being driven across or down the streambed, or any similar disruption.
M. Illegal interstate and foreign commerce dealing in imports or exports of listed or steelhead. Altering lands or waters in a manner that promotes unusual concentrations of predators.
N. Shoreline and riparian disturbances (whether in river, estuary, marine or floodplain environment) may retard or prevent the development of certain habitat characteristics upon which the fish depend (e.g. removing riparian reduces vital shade and cover).
O. Filling or isolating side channels, ponds, and intermittent waters (e.g. installing tidal gates and impassable culverts) can destroy habitats that fish depend upon for refuge during high flows.

CLEAN WATER ACT (CWA)

The Clean Water Act is the nation's primary water quality protection law authorizing the Environmental Protection Agency (EPA) to restrict pollution discharges. Certain sections require permits, based on regulations promulgated by the EPA in conjunction with the State Water Resources Control Board (SWRCB). In many instances, regulatory authority over clean water has been given to the states and is implemented by the State Water Resources Control Board (SWRCB) and the nine California Regional Water Quality Control Boards (RWQCB).

- **Section 401** – Requires that anyone discharging dredge or fill material into a surface water of the U.S. must not violate the State's water quality standards. The State's authority or duty to issue

¹ NMFS. (June 2000). A Citizen's Guide to the 4(d) Rule for Salmon and Steelhead on the West Coast.

401 Water Quality Certifications is dependent on a valid Section 404 application with the Army Corps of Engineers. The State may only enforce 401 for a valid Section 404 project. “Water Quality Certification” is carried out and enforced by the RWQCB.

- **Section 402 and NPDES Phase-II** - Prohibits the discharge of all pollution unless permitted. Notice of Intent (NOI) to SWRCB; permitting by RWQCB. Permit program entitled National Pollution Discharge Elimination System Phase II (NPDES Phase II), provides for permits for discharges of storm water from: (a) construction activity >1 acre of soil disturbance; (b) certain industrial activities including mining and vehicle maintenance (such as County Road Maintenance Yards); and c) municipal facilities, including roads. The Phase II Stormwater permit requirements, effective in March 2003 in most central California coastal counties, address water quality issues in areas of the watershed that are served by a municipal storm sewer system. Phase II compliance will include implementation of BMPs such as published in these guidelines, and the achievement of measurable goals in the following areas: 1) public education, 2) public participation/involvement, 3) illicit discharge detection and elimination, 4) construction site runoff control, 5) post-construction runoff control, and 6) pollution prevention/good housekeeping. Some cities and many construction projects were subject to Phase I municipal and construction permits. Those cities under Phase I MS4 permits currently have different requirements than those under Phase II.
- **Section 404** - Regulates the discharge of dredged or fill material into “waters of the United States”, including tidal and non-tidal wetlands (tied to Sect. 401 State process above). Permitting carried out by US Army Corps of Engineers (COE).
 - **“Waters of the U.S.”** - In nontidal waters, jurisdiction extends:
 - a) to the ordinary high water mark in the absence of adjacent wetlands.
 - b) beyond the ordinary high water mark to the limit of the adjacent wetlands, when present.
 - c) to the limit of the wetland when only wetlands exist.
 - **“Ordinary High Water Mark”** – “That line on the shore established by the fluctuations of water and indicated by physical characteristics such as [a] clear, natural line impressed on the bank, shelving, changes in the character of soil, destruction of terrestrial vegetation, the presence of litter and debris, or other appropriate means that consider the characteristics of the surrounding area.” [33 CFR 328.3(e)]

FISH AND WILDLIFE COORDINATION ACT

- Requires all federal agencies to consult with USFWS, NOAA Fisheries and DFG for activities that “affect, control, or modify waters of any stream or other bodies of water.” These agencies review applications for Clean Water Act Sect. 404 permits and provide comments to the Corps about the environmental impacts of the proposed project.
- Gives USFWS & NOAA Fisheries an expanded responsibility for review of federal projects (including those with federal permits or funding) that includes concerns about general plant and wildlife species that may not be addressed by the Endangered Species Act, particularly a project’s secondary effects.

COASTAL ZONE MANAGEMENT ACT (CZMA)

- Implemented through the State by the Coastal Commission and the County or City Local Coastal Plan (LCP).
- Requires that Clean Water Act Section 404 general permit must comply with CZMA.

NATIONAL ENVIRONMENTAL POLICY ACT (NEPA)

- Requires federal agency decision-makers to document and consider the environmental implications of their actions, including the issuance of permits, funding, and rights-of-entry.

RIVERS AND HARBORS ACT OF 1899 - Section 10

- Prohibits the unauthorized obstruction or alteration of any navigable waters of the U.S. without a permit from the Corps of Engineers (COE).
- Jurisdiction is limited to those activities affecting the “navigable waters of the U.S.” See Figures 2-1 and 2-2.
- Original regulatory authority has been superseded by Section 404 of the Clean Water Act to a great extent.

NATIONAL HISTORIC PRESERVATION ACT OF 1966 – Section 106

- Requires federal agencies to review projects for impacts to historic and archeological resources.
- Requires projects with federal involvement to determine the significance of cultural resources with the Area of Potential Effect.
- Requires consultation and concurrence with the State Office of Historic Preservation (SHPO).

2.2 STATE LAWS AND REGULATIONS

CALIFORNIA FISH AND GAME CODE

➤ Sections 1600-1607 - “Lake and Streambed Alteration Agreement Process”

- Public agencies must comply under Section 1602 of DFG code.
- Requires notification to DFG for any project that will impact a river, stream or lake. Measures to prevent substantial adverse affect on fish or wildlife are developed with applicant in an Agreement.
- Agreement is technically not a “permit” but a “mutual agreement” between DFG and project proponent.
- Projects must also (since 5/1/99) be reviewed under the California Environmental Quality Act (CEQA).
- No pre-notification is required for emergency projects by a public agency to maintain, repair or restore an existing highway, within the existing right-of-way, within one year of damage. Notification required within 14 days of beginning work.
- Jurisdictional limit is usually marked by DFG – in practice - to be at the top of the stream or lake bank or at the outer edge of the riparian vegetation, whichever is wider. However, the broad definition in DFG Code Section 1602 gives DFG great flexibility in deciding what constitutes a stream – sometimes to the 100-year flood plain.

➤ Section 5650 – Water Pollution

- Prohibits anyone from depositing, permitting to pass into, or place where it can pass into the waters of this state, most pollutants, including any petroleum, acid, asphalt, bitumen, or residuary product of petroleum; ...or any substance or material “deleterious to fish, plant life, or bird life.”
- Does not apply to pollution discharged under a permit from RWQCB or SWRCB.

PORTER-COLOGNE WATER QUALITY CONTROL ACT

- Regulates any discharge that may affect waters of the state (which include all surface and ground waters)
- Provides the State with authority to regulate consistent with (and in excess of) CWA requirements. The CWA distinguishes between point (pipe) and nonpoint (runoff) sources of water pollution in California.
- Administered by the State Water Resources Control Board (SWRCB) and the Regional Water Quality Control Boards (RWQCB)

CALIFORNIA ENDANGERED SPECIES ACT (CESA)

Coho salmon in all FishNet Counties are now listed as endangered under the California State Endangered Species Act. (San Mateo and Santa Cruz Counties, 1995; Marin, Sonoma and Mendocino, 2002). A comprehensive Recovery Plan for these listed fish was completed in 2004 by the Department of Fish and Game as part of the State Fish and Game Commission’s agreement on implementing the listing.

- Regulations under CESA prohibit the “take” of plant and animal species designated by the California Fish and Game Commission as either endangered or threatened. Seeks to ensure that action is not likely to destroy or adversely modify “essential habitat” necessary to the continued existence of the species. [Fish & Game Code Sections 2080-2081]
- “Take” includes hunting, pursuing, catching, capturing, killing, or attempting such activity, but does not now include indirect mortality resulting from habitat modification (due to change by recent legislation).

- Section 2080 states no further state authorization needed if a federal ESA’s Section 10 Incidental Take Permit has been obtained.
- Section 2081 authorizes incidental take permits by DFG, under certain conditions. Projects with potential impacts to coho salmon in the central California coastal counties, (*endangered*), require an incidental take permit, 2081.
- (Sect. 2090, state agency consultation requirement, was repealed effective 1/1/99.)
- When a species is also listed under the Federal ESA, DFG must participate in the federal consultation to the greatest extent practicable and adopt the federal Biological Opinion as its Biological Opinion, wherever possible.
- Website: www.dfg.ca.gov/hcpb/ceqacesa/cesa/cesa.html

CALIFORNIA ENVIRONMENTAL QUALITY ACT (CEQA)

- Requires state, regional, and local agencies to assess the significant environmental effects of proposed projects and to circulate these assessments to other agencies and the public for comment before making decisions on the proposed projects.
- Exempts most road maintenance actions through the use of a Categorical Exemption (“CE” or “Cat Ex”), when no potential for significant environmental impact exists. However, there is often potential for impact – e.g. there is a presumption that ESA species are present and may be affected (in this chapter, see *Federal Laws and Regulations: ESA*) – and Cat Exes are limited by the following exceptions (CEQA Title 14, Categorical Exemptions, 15300.2 – Exceptions):
 - Location (e.g. a particularly sensitive environment)
 - Cumulative Impact (of successive projects in same place)
 - Scenic Highways (damage to scenic resources such as trees and rock outcroppings within officially designated state scenic highway)
 - Hazardous Waste Sites
 - Historical Resources

Given that such exceptions can be and are broadly interpreted, it is much more efficient to implement appropriate BMPs to ensure that activities result in less than significant effect.

Cat Ex examples include:

- Class 1 (Existing Facilities): Includes maintenance of existing public facilities, such as road grading for purpose of public safety; rehabilitation of damaged facilities to meet current standards of public health and safety; maintenance of stream channels (clearing of debris) to protect fish and wildlife resources;
- Class 2 : Replacement or Reconstruction of existing facilities involving negligible or no expansion of capacity
- Class 4 (Minor Alterations to Land): Minor alterations (excluding removal of healthy, mature scenic trees), such as grading on slope <10% not in waterway, wetland, or geologic hazard area; filling of earth into previously excavated land.
- Other actions (or group of actions) should achieve CEQA compliance through completion of an Initial Study supporting a Negative Declaration (“Neg Dec”), a Mitigated Negative Declaration (“Mit Neg Dec), or an Environmental Impact Report (EIR).
- Issuance of Local and State permits, such as DFG’s 1602 agreement or a County Use Permit, also must comply with CEQA procedural requirements.

CALIFORNIA COASTAL ACT

- Sets policy for land use within the coastal zone and assigns decision-making and administration to the Coastal Commission

- Implemented at the local level primarily through County or City Local Coastal Plans (LCP) and local agencies, once LCPs are approved by the Coastal Commission.
- No coastal development permit is required for repair and maintenance of existing public roads, including resurfacing, ditch cleaning, and slide removal. A permit is required for excavation or disposal of fill outside of the roadway prism. (Section 30610).

SURFACE MINING AND RECLAMATION ACT (SMARA)

- Requires local government to adopt and implement ordinances regulating upland surface mines and instream gravel mining and to require Reclamation Plans for each mining site obtaining a local use permit.
- Reclamation plans overseen in an advisory capacity by the Calif. Dept. of Conservation, Office of Mine Reclamation.
- Caltrans reviews reclamation plans for mines in the 100-year floodplain, or within 1 mile upstream or downstream of a Caltrans bridge.

2.3 LOCAL GOVERNMENT LAWS AND REGULATIONS

COUNTY GENERAL PLANS, COMMUNITY PLANS AND LOCAL COASTAL PLANS

- The Countywide General Plan, establishes land use designations, standards, and policies, which may address erosion control, water quality protections, riparian set-backs, and other habitat-related issues. Community Plans establish priorities based on regional resources and community values and visions.
- Local Coastal Plans (LCPs) must comply with the California Coastal Act.
 - Are adopted as an element of the General Plan and provide special standards and policies for activities within the coastal zone (extending up to five miles inland from the mean high tide line).
 - Clean Water Act Section 404 general permit must comply with Coastal Zone Management Act (CZMA), which is implemented through the State by the Coastal Commission and the County or City LCP.

COUNTY ORDINANCES

Each County has a suite of ordinances that are implemented through County Code. Ordinances are often the vehicle whereby a vision from a county plan is enacted into law. Table 2-2 lists the General Plan Elements and Ordinances found in the FishNet counties that directly or indirectly pertain to salmonid fishery and stream habitat protection.²

Table 2-2. County General Plan Elements and Ordinances

County	General Plan Elements	Ordinances
Marin	Environmental quality element	Dam permit (amendment), Chapter 11.04
	Community development element	Watercourse diversion & obstruction, Chapter 11.08
	Transportation element	Grading, Chapter 19.08
	Housing element	Native tree preservation, Chapter 22.xx
	Noise element	Mining and quarrying, 23.06 (amendment)
	Environmental hazards element	Excavating, grading & filling, Chapter 23.08
	Agricultural element	Urban runoff, Chapter 23.18
	Community facilities element	Integrated pest management, Chapter 23.19
	Parks and recreation element	Improvements, Chapter 24.04
	Trails element	Drainage, Chapter 24.04.520
	Economic element	Grading, Chapter 24.04.620
	Local coastal plan unit I	Miscellaneous (bridges), Chapter 24.02.875
	Local coastal plan unit II	Local Coastal Plan code Chapter 22.56
	Tamalpais Area Community Plan	Riparian Zone Protection Ordinance
San Geronimo Valley Community Plan		
Point Reyes Station Community Plan		
Monterey	Natural resources, Chapter I	Grading ordinance, Chapter 16.08
	Environmental constraints, Chapter II	Erosion control ordinance, Chapter 16.12
	Human resources, Chapter III	Floodplain regulations, Chapter 16.16
	Area development, Chapter IV	Preservation of Oak and Protected Trees, Chapter 16.60
	Countywide land use, Chapter V	Pajaro River banks & levees, Chapter 16.65
	Carmel Area Plan	Subdivision Ordinance, Title 19
	Carmel Valley Master Plan	Zoning ordinance, Title 21

² Harris, R.L. (January 2001). Effects of County Land Use Policies and Management Practices on Anadromous Salmonids and Their Habitats.

County	General Plan Elements	Ordinances
	South County Area Plan	
	Greater Monterey Peninsula Area Plan	
	Toro Area Plan	
	Cachagua Area Plan	
	Central Salinas Valley Area Plan	
	North County Area Plan	
San Mateo	Vegetation, water, fish and wildlife, Chapter 1	Growth management
	Soil resources, Chapter 2	Floriculture
	Mineral resources, Chapter 3	Sensitive habitats
	Visual quality, Chapter 4	Riparian corridors
	Historical and resources, Chapter 5	Rare and endangered species
	Park and recreation resources, Chapter 6	Visual resources
	General land use, Chapter 7	Natural hazards
	Urban land use, Chapter 8	Recreation and visitor serving facilities
	Rural land use, Chapter 9	Zoning ordinance
	Water supply, Chapter 10	Excavation, grading, filling, clearing, Section 8600
	Waste water, Chapter 11	Grading permit standards handbook
	Transportation, Chapter 12	Significant tree ordinance 11,000 - 12,000
	Solid waste, Chapter 13	Riparian corridor/ zoning ordinance update
	Housing, Chapter 14	Storm Water Management Ordinance, Section 5000
	Natural hazards, Chapter 15	
	Local Coastal Plan	
	Man-made hazards, Chapter 16	
Santa Cruz	Land use element	Zoning ordinance, Chapter 13.10
	Circulation element	Site and landscape design review, Chapter 13.11
	Housing element	Coastal zone regulations, Chapter 13.20
	Conservation and open space element	Subdivision ordinance, Chapter 14.01
	Public safety and noise element	Geologic hazards, Chapter 16.10
	Parks, recreation and public facilities	Grading regulations, Chapter 16.20
	Community design	Erosion control, Chapter 16.22
		Riparian corridor protection, Chapter 16.30
		Sensitive habitat protection, Chapter 16.32
		Significant Tree Ordinance- Chapter 16.34
		Mining regulations, Chapter 16.54
Sonoma	Land use element	Erosion control plans required, Chapter 7
	Housing element	Flood damage prevention, Chapter 7
	Open space element	Storm water quality, Chapter 11
	Agricultural resources element	Watercourse protection ordinance 1108
	Resources conservation element	Anti roiling ordinance, Chapter 23, 3836R
	Public safety element	Zoning ordinance, Chapter 26
	Circulation and transit element	Vineyard erosion and sediment control ordinance , Chapter 30
	Air transportation element	
	Public facilities and services element	
	Noise element	

2.4 PERMITS

Permits are needed from different agencies for many types of project and purposes. To help you find out what permit is required, from which agency, and for what types of projects, three tables are provided below. You can look up the permit by agency name, by permit name, or by project type.

Once you have a permit, you need to know what is important about its contents. A checklist of important categories to look for in each permit is provided. Compliance with the rules is essential – penalties and fines for the county and individuals can be stiff. A significant change in the project must be run by all permitting agencies.

Table 2-3. Types of Permits- By Agency

AGENCY	PERMIT	WHAT TYPES OF PROJECTS
➤ Federal		
U.S. Army Corps of Engineers (COE)	CWA Section 404 Permit	Projects that will deposit dredged or fill material into “waters of the U.S.”, including wetlands
	<ul style="list-style-type: none"> • Individual Permit 	All activities not covered by General Permit (see below)
	<ul style="list-style-type: none"> • General -Nationwide Permit (NWP) 	Categories of activities with minimal impacts on aquatic resources: #3 – Maintenance #7 – Outfall Structures and Maintenance #12 – Utility Line Activities #13 – Bank Stabilization #14 – Linear Transportation Crossings #23 – Approved Categorical Exclusions #27 – Stream & wetland restoration #33 – Temporary Construction, Access, and Dewatering #41 – Reshaping existing drainage ditches #43 - Storm Water Management Facilities
	<ul style="list-style-type: none"> • Regional General Permit (RGP) 1 – San Francisco District 	Only for fish passage/ sediment reduction projects at water crossings in the San Francisco District
NOAA Fisheries	ESA Section 4(d) rules ESA Sect. 7 Consultation to COE 404 permit, or other federal agency ESA Section 10	When project involves work in a stream with listed salmon or steelhead species.
Fish and Wildlife Service (USFWS)	ESA Sect. 7 Consultation to COE 404 permit or other federal agency	When project could jeopardize an endangered or threatened species (non-anadromous) or result in adverse impact to its critical habitat

AGENCY	PERMIT	WHAT TYPES OF PROJECTS
	ESA Section 10	
➤ State		
Dept. of Fish & Game (DFG)	Fish & Game Code Sect. 1602 Streambed Alteration Agreement	Instream projects / culverts / stream crossings / fish screens/ water & stream diversions / bank stabilization/ bridges / riparian plant removal
	CESA Section 2081 Incidental Take Permit	For projects likely to cause the death of a species listed as threatened or endangered under CESA
State Water Resources Control Board (SWRCB) / Regional Water Quality Control Bd. (RWQCB) – North Coast Region	CWA Section 401 – Water Quality Certification	Same as 404 (Corps) – 401 needed whenever 404 required. If no 404 required (isolated wetlands), may need waste discharge requirements (WDR) or waiver under Porter-Cologne Act. File Notice of Intent (NOI) with RWQCB.
	CWA Section 402 – NPDES Storm Water Permit National Pollution Discharge Elimination Systems	Construction projects that cover > 1 acre of soil disturbance; in areas of industrial and municipal operations and maintenance programs, . NPDES storm water permits, both construction and municipal, require consideration of runoff treatment systems to minimize impacts of runoff discharges.
	Waste Discharge Requirements (WDRs or WDR waivers)	Any project involving activity within waters of the state (including wetlands). Note: The definition of “waters of the state” is broader than “waters of the U.S.” Therefore, projects not subject to a CWA Section 404 permit (headwaters, isolated water bodies, etc.) may still require permits from this agency
State Lands Commission (SLC)	Land use lease	Installation of structures or disposal of dredged material on beds of navigable streams, bays and estuaries.
Lead Agency	CEQA compliance (not a permit)	State permit-issuing agencies must comply with CEQA process during permit process
Local – County / City		
Planning Dept.	Use or Conditional Use permit Grading and Building permit Significant Tree Removal permit Riparian Exception	Rock quarries / gravel extraction Stream bank projects Vegetation management
Public Works Dept.	Grading permit Encroachment permit	Soil disturbance > X cu. yds. (depending on county grading ordinance)
Lead Agency	CEQA compliance (not a permit)	Permit-issuing agency must comply with CEQA process during permit process

Table 2-4. Types of Permits – By Permit Name

PERMIT Informal / Formal Name	AGENCY	PURPOSE
“401” / CWA Section 401 – Water Quality Certification or Waiver	SWRCB / Regional Water Quality Control Bd. (RWQCB) – North Coast Region	Same as 404, but for up to 5 years and multiple projects.
“402” or “SWP” / CWA Section 402 – Storm Water Permit		Storm water runoff – minimize impacts
“404” / CWA Section 404 permit	U.S. Army Corps of Engineers (COE)	Protection of wetlands and waters of the U.S. from discharge of dredged or fill material
• Individual permit		Regulate specific activities on an individual basis
• General – Nationwide Permit “NWP”		Regulate specific categories of activities, usually with minimal impacts on aquatic resources, on a national basis
• “RGP” or Regional General Permit		Regulate specific categories of activities, usually with minimal impacts on aquatic resources, on a regional basis
• Section 4(d) ESA Rule • Section 7 Consultation / • Section 10 HCP / “take” for monitoring & research	NOAA Fisheries	Protect federally-listed anadromous fish species (salmon & steelhead & habitat)
	U.S. Fish & Wildlife Service (USFWS)	Protect other federally- listed species & their habitat
“1602” / Fish & Game Code Sect. 1602 Streambed Alteration Agreement	Calif. Dept. of Fish & Game (DFG)	Ensure no net loss of stream habitat values or acreage
“2081” / Fish & Game Code Sect. CESA Incidental Take Permit		Protect State-listed animal and plant species & habitat
CEQA compliance (not a permit)	Lead Agency = Implementing or Permit-issuing agency	Assess the significant environmental effects of proposed projects.
Use permit or Conditional Use permit; Building permit; Grading permit	County or City Planning Dept.	Ensure compliance with General Plan & ordinances
Local Coastal permit	County or City Planning Dept.	Ensure wetland impacts are avoided or minimized in the coastal zone
Grading permit	County or City Public Works Dept.	Minimize or avoid erosion and sedimentation

Table 2-5. Permits by General Permit Type for Routine Road Maintenance

General Road Maintenance Project Category	General Environmental Concerns about Activity	Permits or Approval that may be required
Streambank erosion control	<ul style="list-style-type: none"> • Sediment discharge to stream • Riparian plant impact 	<ul style="list-style-type: none"> • 404 CWA permit – NWP #13 or RGP #1 • 401 CWA permit

General Road Maintenance Project Category	General Environmental Concerns about Activity	Permits or Approval that may be required
		<ul style="list-style-type: none"> • NOAA Fisheries consultation • 1602 DFG agreement
Ditch maintenance	<ul style="list-style-type: none"> • Sediment discharge to stream from ditch • Aquatic habitat removal 	<ul style="list-style-type: none"> • 404 CWA permit if “water of the US” – NWP #41 for reshaping • 401 CWA if 404 needed • 1602 DFG agreement ?? • ESA consultation ??
Culvert maintenance & replacement	<ul style="list-style-type: none"> • Sediment or debris discharge into stream • Fish stranding or blockage to migration 	<ul style="list-style-type: none"> • 1602 DFG agreement • 404 CWA – NWP #14 or RGP #1 • 401 CWA • Consultation with NOAA Fisheries and possible permit.
Vegetation management	<ul style="list-style-type: none"> • Loss of riparian plants • Create erosion risk 	<ul style="list-style-type: none"> • County Tree Ordinance • 1602 DFG if working within riparian zone • County Pesticide Ordinance • Special use permit if trees located on federal land • May require a Habitat Conservation Plan
Spoil disposal	<ul style="list-style-type: none"> • Sediment and debris discharge to stream • Harms slope stability of site • Filling wetlands 	<ul style="list-style-type: none"> • County conditional use permit / coastal permit • County grading permit • Special use permit if on federal land • 404 CWA if wetlands or floodplain involved • 401 CWA if 404 needed • Possible Section 7 permit ??
Maintenance yard Management	<ul style="list-style-type: none"> • Stormwater runoff of stored materials to streams • Spills of hazardous materials • Contamination of groundwater & soils 	<ul style="list-style-type: none"> • 402 CWA Stormwater Plan & General Industrial Stormwater Permit • County Pesticide Ord. • Compliance with County Spill Plan • CWA Waste Discharge Permit for petroleum discharge to septic system or for oil/water separators
Bridge maintenance	<ul style="list-style-type: none"> • Discharge of bridge materials into stream • Damage to riparian area • Harm to bats & swallows 	<ul style="list-style-type: none"> • CWA Waste discharge permit for lead-based paint discharge • DFG & USFWS notification • 404 CWA permit for instream work • 401 CWA permit for

General Road Maintenance Project Category	General Environmental Concerns about Activity	Permits or Approval that <u>may</u> be required
		instream work <ul style="list-style-type: none"> • 1602 DFG agreement for instream work
Emergency maintenance (Typical emergency response activities include: storm damage patrol; debris removal; emergency opening or closing of a road; and repairs to roads, slopes, and drainage facilities.)	<ul style="list-style-type: none"> • Discharge of sediment and debris into stream system • Stream habitat damage due to heavy equipment instream or in riparian zone 	<ul style="list-style-type: none"> • 1602 DFG post-project notification • 404 CWA pre-project notification • 401 CWA post-project notification • Hazardous spill notification process to checklist agencies

CATEGORIES OF PERMIT CONDITIONS

The following checklist includes most of the categories of requirements, conditions, mitigations, and limits often placed on a permit. Permit conditions and project mitigations protect against both direct impacts and potential impacts to the species or habitat.

- ❑ **Project Description and Purpose** – Scope of proposed action
- ❑ **Timing of Project Actions** – Limits to season, month, time of day, particularly **Limited Operating Periods** (LOPs) which can restrict action during special periods for sensitive animals (e.g., spawning, nesting)
- ❑ **Project Location** – Map or description of project site
- ❑ **Mitigations** included in the original Project Description – Practices proposed by the applicant (County) to minimize or avoid environmental impacts
- ❑ **Revised or Additional Mitigations** – Other practices required by the permitting agency) to minimize or avoid environmental impacts
- ❑ **Monitoring Requirements** – Records that must be kept and data that must be collected during and after the project
- ❑ **Endangered or Threatened Species** – List of those known or possible at the site
- ❑ **Site Inspections** – Who and when an agency representative may need to be on-site during the project and his/her right to be there
- ❑ **Emergency Actions** – Clarifies which emergency actions can begin without prior notification or permit; agency must still be notified after action has begun.
- ❑ **Duration of Permit** – Beginning and Ending Date of permit’s active status
- ❑ **Penalties for Violation** of Permit Conditions – Potential fines and jail sentence
- ❑ **Biological Assessment (BA)** – As required by federal Endangered Species Act
- ❑ **Alternatives Analysis** - Alternative actions to the original proposal

ARE THESE PERMITS ALWAYS REQUIRED?

The need for permits and CEQA compliance can depend on the size and location of a project and the methods being used for the project. Site-specific conditions are important to consider. For more specific information on permits needed for each project or BMP, see “Permits” at the end of each maintenance activity in Chapters 5-10.

BEFORE performing a Routine Maintenance Project, be sure of the following:

- ✓ All necessary permits / agreements / consultations are completed for this project and are on site at the project.
- ✓ The final permit paperwork is available in the Project file.
- ✓ Review with all road crew involved, the specific conditions listed on the permits (see Permit Conditions above) *and make sure they understand the requirements.*
- ✓ Post Final permits on site, if required. DFG 1602 Agreements must be available on site.
- ✓ Notify permit-issuing agencies prior to beginning the project.

CONSEQUENCES OF NOT COMPLYING WITH PERMIT REQUIREMENTS

If permits are not complied with, or the necessary permits are not obtained, the penalties to the County (with liability including the responsible individual) for unpermitted activity can be quite strong:

1. **Regional Water Quality Control Board (RWQCB)** enforcement of violations to the Clean Water Act, the Porter-Cologne Act, and the Basin Plan can involve the following actions:
 - a) Administrative Civil Liabilities, with fines at \$10 per gallon of spill (\$2,000 /cu. yd., or \$20,000 per 10 yd. dump truck) of liquid or sediment. (One cubic yard of soil is equivalent to 202 gallons.)
 - b) Cleanup and Abatement Order – with fines for non-compliance
 - c) Time Schedule Order – with fines for non-compliance with deadlines
 - d) Cease and Desist Order – subject to fines
 - e) Fines < \$50,000 can be issued by the Executive Officer or Board; larger fines can be decided by the Board.
2. **California Dept. of Fish and Game (DFG)** can issues fines and penalties for violations of the **Fish & Game Code** (see Section 12000-):
 - a) Most violations are misdemeanors.
 - b) Punishment is a fine <\$1,000, imprisonment in the county jail for not more than six months, or both fine and imprisonment.
 - c) Violation of pollution prohibitions under F& G Code Section 5650 punishable by civil penalty of not more than \$25,000 for each violation; imprisonment in the county jail for not more than one year, or both fine and imprisonment. Person is also liable for all actual damages and for reasonable costs incurred in cleaning up the deleterious substance or material.
 - d) Punishment for a second or subsequent violation of Section 1602 on the same project or streambed alteration agreement, or any violation of the State Endangered Species Act (CESA), is a fine of <\$5,000 or imprisonment in the county jail for a period not to exceed one year, or both.
3. **Federal Endangered Species Act (ESA)** violations are assessed by the NOAA Fisheries Director (SW Region) or the USFWS Director (Western Region) and may involve the following penalties:
 - a) Civil penalty of up to \$25,000 per violation against any person who knowingly violates any provision of the ESA or any regulation issued to implement the taking and no damage/destruction provisions of Section 9.
 - b) Criminal penalties of up to \$50,000 (total) and/or one year's imprisonment for knowing violations of the act or regulations.
 - c) Penalties are most often assessed against private individuals and entities for section 9 violations.
 - d) Citizens may bring suit to enforce the act when compliance is not followed.

- 4. Clean Water Act Section 404 (EPA and ACOE) violations** are similar to the RWQCB actions above. Both the Corps (ACOE) and the EPA have independent enforcement authority.:
- a) Administrative penalties for EPA involve:
 - i) Class I violations – for less serious unpermitted activities, carry a maximum of \$10,000 per violation, with a total maximum of \$25,000;
 - ii) Class II violations – for more serious unpermitted activities, carry a maximum of \$10,000 per day for each day during which the violation continues, with a total maximum of \$125,000.
 - b) Corps’ enforcement has a maximum of \$25,000 per day for both classes.
 - c) Negligent violations carry misdemeanor sanctions, including penalties of \$2,500 to \$25,000 per day and imprisonment of up to one year.
 - d) Known violations carry felony sanctions, including penalties of \$5,000 to \$50,000 per day and imprisonment of up to three years.

TIME REQUIRED TO OBTAIN A PERMIT

Since the time for obtaining necessary permits can be lengthy and delay the start of road maintenance projects, it is very important to begin the permit process as soon as possible and to start the clock ticking on each of the permits that will or may be needed. Pre-consultation prior to permit application is highly encouraged. Table 2-4 lists the estimated time required for most permits. Some permit time schedules are established by statute (*), while other time periods are set at the discretion of the agency. Timing can also be delayed by complex projects, incomplete application materials, insufficient staffing for permit reviews, and “surprise” issues during inspection of the proposed project site. Note that the clock usually does not start ticking until the agency formally deems the application to be “complete”.

Table 2-6. Estimated Time Required for Permits by Permit Name

PERMIT / Other Requirement	AGENCY	TIME REQUIRED Minimum / Maximum
401 CWA – Water Quality Certification or Waiver (from discharge requirements)	RWQCB – Regional Water Quality Control Board	30 days to determine if application is “complete”; 60 days from complete application
402 CWA – General Storm Water Permit	RWQCB / SWRCB	Valid on receipt of complete Notice of Intent (NOI) (30 days)
404 CWA – Individual	COE – US Army Corps of Engineers	60-90 days / 2 years + (?)
404 CWA – General / Nationwide		30 days to determine if application complete; 45 days from “complete” application
404 CWA – General / Regional (RGP)		Same as Nationwide
Section 4(d) rule take limitation	NOAA Fisheries or	No time limit
Section 7 ESA - Informal Consultation	US Fish & Wildlife Service (USFWS)	30 days to get species list + 180 days max. for Biological Assessment (BA) + 30 days to accept BA*

Section 7 ESA - Formal Consultation		135 days max. for Biological Opinion, after acceptable BA is received.* (unless agreement to extend)
Section 10 ESA - Habitat Conservation Plan - Incidental Take Permit		No time limit
1602 – F&G Streambed Alteration Agreement	DFG – Calif. Dept. of Fish and Game	45 days* / 65 days*
2081 – CESA - Incidental Take Permit		120 days *
Use Permit	County / City	45-90 days
Grading Permit	County / City	varies

* Time limit set by statute

MOST COMMON PLAYERS IN THE PERMIT PROCESS

The following county, state and federal agencies are the most common players setting the conditions for projects that could potentially affect water quality, stream habitat, or salmon and steelhead fisheries. Getting to know the abbreviations or acronyms for the agencies and types of permits is helpful in permit discussions (See *Appendix B - Glossary*).

- **County / City Planning, Public Works, and Environmental Health Departments**
 - ◆ Responsible for permits to be issued under ordinances, such as Grading and Riparian Protection Ordinances, Tree Protection, Surface Mining and Reclamation, and encroachment.
- **California Dept. of Fish and Game (DFG)**
 - ◆ Responsible state agency for the public trust resources of fish and wildlife in California
 - ◆ Regulates activities potentially resulting in alteration of streambeds and banks or diversion of a stream's natural flow, as per the Fish and Game Code Section 1600
 - ◆ Protects species listed under the California Endangered Species Act (CESA).
 - ◆ Commenting agency (not permit-issuing) for federal and state permits under the Clean Water Act, Coastal Act and for regulations under CEQA
 - ◆ Website: [//www.dfg.ca.gov](http://www.dfg.ca.gov)
- **Regional Water Quality Control Boards; in the FishNet Region this includes the North Coast, San Francisco Bay and Central Coast Regional Boards**
 - ◆ Responsible agency for implementation of the State Porter-Cologne Water Quality Control Act and the Federal Clean Water Act.
 - ◆ Regulates activities that may potentially discharge pollutants into watercourses or storm water drainage systems.
 - ◆ Administers permit program entitled National Pollution Discharge Elimination System (Phase I & II), provides for permits for discharges of storm water from: (a) construction activity >1 acre of soil disturbance; (b) certain industrial activities including mining and vehicle maintenance (such as County Road Maintenance Yards); and c) municipal facilities, including roads.
 - ◆ Issues certifications under the Clean Water Act, such as the Sect. 401 certification required for a US Army Corps of Engineers permit under Sect. 404

- ◆ Issues Waste Discharge Requirements (WDRs) under the State Porter-Cologne Act; (WDRs are the main state permitting tool as authorized by the California Water Code). Such permits may be issued for any discharge of waste that could affect waters of the state, including wetlands.
 - ◆ Regulates potential discharge of pollutants into all surface and ground waters, including “creeks,” a term that includes drainage ditches and similar waterways with beneficial uses
 - ◆ Website: // www.swrcb.ca.gov/rwqcb1 (North Coast); www.swrcb.ca.gov/rwqcb2 (SF Bay); www.swrcb.ca.gov/rwqcb3 (Central Coast)
- **California Coastal Commission** (coastal counties only)
- ◆ Responsible for administering the California Coastal Act and the federally approved California Coastal Management Program of the Coastal Zone Management Act (CZMA)
 - ◆ Regulatory jurisdiction within the coastal zone varies in dimensions along the coast, with a maximum extension of up to five miles inland from the mean high tide line. Permit jurisdiction for proposed projects within the immediate ocean or bay shoreline (tidelands, submerged lands, and public trust lands)
 - ◆ Counties and cities implement Coastal Act policies through their adopted Local Coastal Plans (LCPs) certified by the Coastal Commission. Coastal Zone permits are permits are usually issued by local planning agency, such as a county or city.
 - ◆ Coordinates with local and state commenting agencies
 - ◆ Website: // www.coastal.ca.gov
- **U.S. Army Corps of Engineers (US ACOE)**
- ◆ Major agency responsible for regulation of Sect. 404 under the federal Clean Water Act, which includes “waters of the U.S.” and almost all wetlands. Jurisdiction essentially includes all bodies of surface water in California.
 - ◆ Coordinates with federal consulting agencies and DFG (under the Fish & Wildlife Coordination Act) for its permit process
 - ◆ Initiates consultation with NOAA Fisheries and USFWS under the Endangered Species Act
 - ◆ Website: // www.spn.usace.army.mil/regulatory/
- **NOAA Fisheries**
- ◆ Responsible agency for almost all marine species, including protection of salmon and steelhead listed as threatened or endangered under the federal Endangered Species Act, and their designated critical habitat; also implements Essential Fish Habitat (EFH) under the Magnuson-Stevens Fishery Conservation and Management Act
 - ◆ Issues Incidental Take Permits under Section 10 of the Endangered Species Act for non-federal projects involving a “take” of species federally listed as threatened or endangered; indirect take associated with otherwise lawfully authorized activities, and direct take for research and monitoring.
 - ◆ Conducts ESA Section 7 consultation for any activity funded, carried out or permitted by a federal agency that might jeopardize the continued existence of a listed salmon or steelhead species or adversely affect their critical habitat.
 - ◆ Consulting agency (not permit-issuing) for federal Clean Water Act permits (Sect. 404), and for any project (permits, funding, assistance, etc.) due to Fish and Wildlife Coordination Act requirement and/or involving other federal agencies such as FEMA, EPA, and Federal Highways.
 - ◆ Websites: SW Region – <http://.swr.nmfs.noaa.gov>; NW Region – <http://.nwr.noaa.gov>

- **U.S. Fish and Wildlife Service (USFWS)**
 - ◆ Responsible agency for protection of terrestrial and non-marine (non-salmon) aquatic species listed as threatened or endangered under the federal Endangered Species Act
 - ◆ Commenting agency (not permit-issuing) for federal Clean Water Act permits (Sect. 404) and for any project with federal involvement (permits, funding, assistance, etc.) due to Fish and Wildlife Coordination Act requirement.
 - ◆ Issues Incidental Take Permits under Section 10 of the Endangered Species Act for non-federal projects involving a “take” of federally listed species. (see ESA section below for definitions of “take”).
 - ◆ Conducts ESA Section 7 consultation for any activity funded, carried out or permitted by a federal agency that might jeopardize the continued existence of a listed non-salmon species or adversely affect their critical habitat.
 - ◆ Website: [//www.ccfwo.r1.fws.gov/](http://www.ccfwo.r1.fws.gov/)

LESS COMMON PLAYERS IN THE PERMIT PROCESS

Only in limited instances do the following agencies require permits or get involved in the permit process for county road maintenance projects:

- **California Dept. of Conservation**
 - ◆ Office of Mine Reclamation implements reporting, compliance, and reclamation requirements of the Surface Mining and Reclamation Act (SMARA) for rock and gravel mines and quarries
 - ◆ Website: [//www.consrv.ca.gov/omr/](http://www.consrv.ca.gov/omr/)
- **State Lands Commission (SLC)**
 - ◆ Authorizes leases for use of the state’s tide and submerged lands and beds of historically navigable rivers, including sites for bridge supports
 - ◆ Website: [//www.slc.ca.gov/](http://www.slc.ca.gov/)
- **State Water Resources Control Board (SWRCB)**
 - ◆ Responsible State agency for enforcement of the Porter-Cologne Act and Clean Water Act.
 - ◆ Delegates most federal and state water quality permit and enforcement activity to its 9 Regional Water Quality Control Boards (RWQCB)
 - ◆ Oversees water rights applications, allotments and permits for water diversions
 - ◆ Adopts statewide General Permit for Storm Water Discharges, issued by SWRCB and enforced by the RWQCBs.
 - ◆ Oversees and regulates statewide general permits which include construction, industrial, linear construction, and Small MS4 permits.
 - ◆ Website: [//www.swrcb.ca.gov/](http://www.swrcb.ca.gov/)
- **U.S. Environmental Protection Agency (EPA)**
 - ◆ Delegates most federal water quality permit and enforcement activity to the State
 - ◆ Reserves compliance authority for runoff (“nonpoint source”) pollution unless delegated to the State (delegated to RWQCBs in California)

- ◆ Shares responsibility with RWQCB for developing Total Maximum Daily Load (TMDL) allocation for pollutants for listed North Coast streams; gives final approval authority for each proposed TMDL.
 - ◆ Website: //www.epa.gov/ow
- **Federal Highway Administration (FHWA)**
- ◆ Funds many road and bridge rehabilitation projects and emergency repairs on Forest Highways, including STIP & HBRR.
 - ◆ Federal funding triggers environmental review under the National Environmental Policy Act (NEPA), Endangered Species Act (Section 7 Consultation), and Historic Preservation Act (Section 106 consultation).
 - ◆ Website: //www.fhwa.dot.gov
- **U.S Forest Service (USFS)**
- ◆ Requires an easement, encroachment, right-of-way or Special Use Permit on repairs to Forest Highways (local roads through National Forests) if working outside of the transportation easement.
 - ◆ Administers projects under the Emergency Relief for Federally Owned Roads (ERFO).
 - ◆ USFS involvement triggers NEPA, ESA Section 7, National Historic Preservation Act Section 106, and other requirements, depending on the Forest Plan or other land management plan.
 - ◆ Website: //www.r5.fs.fed.us/
- **Bureau of Land Management (BLM)**
- ◆ May own road right-of-way or adjacent land needed for road project staging and construction.
 - ◆ BLM involvement triggers NEPA, ESA Section 7, National Historic Preservation Act Section 106, and other requirements, depending on the Forest Plan or other land management plan.
 - ◆ Website: //www.ca.blm.gov/caso
- **State Historic Preservation Office (SHPO)**
- ◆ Consults with federal agencies regarding the significance of historic and archaeological resources in the projects' Area of Potential Effect for projects outside the County's right-of-way, with federal involvement.
 - ◆ Website: //ohp.parks.ca.gov
- **Underground Service Alert (USA)**
- ◆ Not an agency, this non-profit service helps locate underground facilities before excavation or drilling projects are begun. Requires at least 2 working days notice before digging once excavation limits are marked. Contact (800) 642-2444.

2.5 REGULATORY AGENCY CONTACTS FOR FISHNET 4C

Agency Contact	Sonoma	Marin	San Mateo	Santa Cruz	Monterey
Department of Fish and Game Streambed Alteration Program					
Bay Delta Headquarters Yountville, CA (707) 944-5520	X	X	X	X	
Central Region Headquarters Fresno, CA (559) 243-4005					X
U.S. Army Corps of Engineers Regulatory Branch					
San Francisco District San Francisco, CA (415) 503-6795	X	X	X	X	X
Regional Water Quality Control Board 401 Certification					
North Coast RWQCB Santa Rosa, CA (707) 576-2220	X				
San Francisco Bay RWQCB Oakland, CA (510) 622-2300		X	X		
Central Coast RWQCB San Luis Obispo, CA (805) 549-3147				X	X
NOAA Fisheries Northern CA Habitat Coordinator					
Southwest Region Santa Rosa, CA (707) 575-6050	X	X	X	X	X
U.S. Fish & Wildlife Service					
Coast-Bay Delta Branch, Sacramento Field Office Sacramento, CA (916) 414-6625	X	X	X	X	X
California Coastal Commission					
North Central Coast District San Francisco, CA (415) 904-5260	X	X	X		
Central Coast District Santa Cruz, CA (831) 427-4863				X	X

2.6 PERMITTING REFERENCES

- Bass, R., Herson, A., and K. Bogdan. (1999). CEQA Deskbook: A Step-By-Step Guide On How To Comply With The California Environmental Quality Act, (2nd edition) Solano Press Books, Pt. Arena, CA. [(707)884-4508]
- California Dept. of Fish and Game. (2000). “Lake & Streambed Alteration Agreement Process,” Sacramento. 153 p. [[//www.dfg.ca.gov/1600/1600.html](http://www.dfg.ca.gov/1600/1600.html)]
- Cylinder, P.D., Bogdan, K.M., Davis, E.M., and A. I. Herson. (1995). Wetlands Regulation: A Complete Guide To Federal And California Programs, Solano Press Books, Pt. Arena, CA. 363 p. [(707)884-4508]
- Jones & Stokes Associates, Inc. (1997). Handbook Of Regulatory Compliance For The Anadromous Fish Restoration Program. Sacramento, CA. Prepared for U.S. Fish and Wildlife Service, Stockton, CA. [(209)946-6400]
- Mueller, T.L. (1996). Guide To Federal And California Endangered Species Laws, Planning And Conservation League Foundation. Sacramento. [(916) 444-8726]
- National Marine Fisheries Service. Endangered Species Act – Section 7 and Section 10 handbooks. [[//www.nwr.noaa.gov/](http://www.nwr.noaa.gov/)]
- National Marine Fisheries. (June 2000). A Citizen’s Guide to the 4(d) Rule for Salmon and Steelhead on the West Coast.
- Oregon Association of Clean Water Agencies. (2000). Endangered Species Act Assessment Manual. Prepared by CH2MHill. [(503)236-6722, or [//www.oracwa.org](http://www.oracwa.org)]
- U.S. Fish and Wildlife Service. “Habitat Conservation Plans and the Incidental Take Permitting Process.” [[//endangered.fws.gov/hcp/hcpplan.html](http://endangered.fws.gov/hcp/hcpplan.html)]

CHAPTER 3

WORKING IN THE WATERSHED

All rivers and streams drain from a basin- an area called a watershed. What happens in each watershed affects the quality of the streams and the fish habitat they provide. This chapter gives a basic background on how watersheds work.

Watershed Basics

- ◆ The Watershed Approach
- ◆ What is a Watershed?
- ◆ Watershed Elements and Processes
- ◆ Water Quality

THE WATERSHED APPROACH

Understanding and managing watersheds is useful in the mitigation of local road-related environmental problems because:

- Salmon and steelhead species in our Central Coast watersheds are now listed, or proposed to be listed, as threatened or endangered under the Federal and State Endangered Species Act, leading to new legal restrictions on watershed activities.
- Many of our streams in the region are listed under the federal Clean Water Act as “impaired” by excessive sediment & temperature, triggering a requirement for TMDL non-point source pollution limits for each stream system.
- Since water moves downstream in a watershed, and road work and other watershed activities can affect water quality at locations downstream, it takes a “big picture” watershed view to solve human-caused problems.
- Solutions need to address the causes and not just the symptoms of stream and fishery conditions – and the watershed approach provides a way to do this.

WHAT IS A WATERSHED?

The basic definition of a watershed is fairly simple:

Watershed – an area of land which drains water, sediment, and dissolved materials into waterways; defined by the ridges of the hills or mountains that divide them.

Other terms often used to mean the same thing include: basin, drainage, or catchment. While technically the term ‘watershed’ can refer to any size of an area, there is less confusion if terms are consistently used and defined by size. A system of terms exists for subdividing large watersheds into smaller ones, based on relative watershed size:

River Basin – A river system or a group of streams composing a coastal drainage area.

Subbasin - A geographic area representing part or all of a surface drainage area, a combination of drainage areas, or a distinct hydrologic feature. Almost all subbasins are larger than 700 square miles in size, though some in Northern California are smaller.

Watershed – The next smallest subdivision of a subbasin.

Subwatershed – A logical subdivision of an area within a watershed, based on geography (major tributary) or a distinctive feature or use (municipal water supply).

Drainage – An area within a subwatershed based on the development of the stream channel network, including draws and swales.

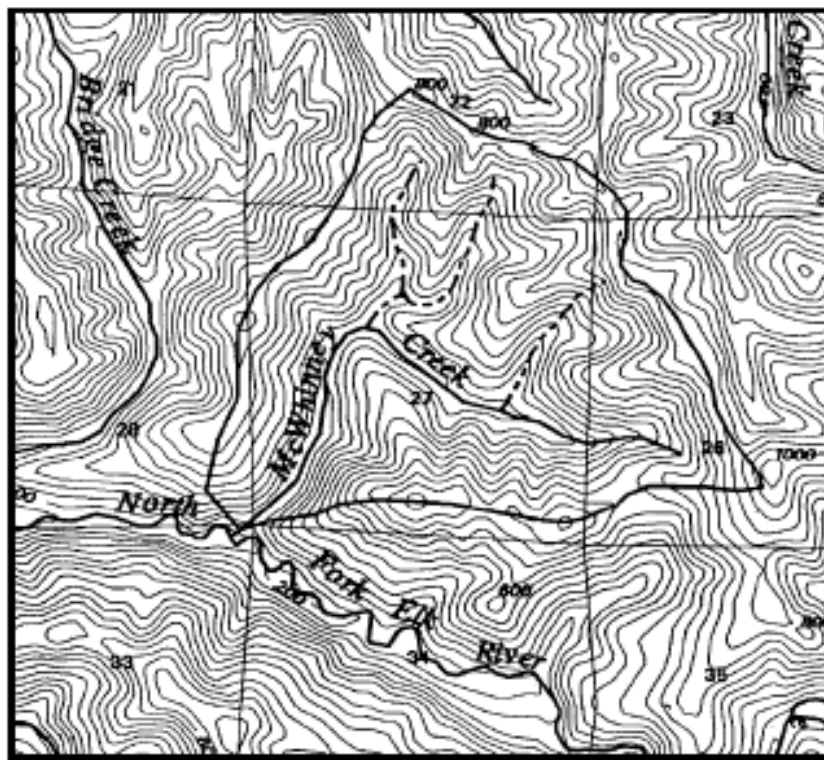

Figure 3.1 Drainage area calculation

WATERSHED ELEMENTS AND PROCESSES

Water Courses

Water flowing through channels has many different names as well: river, stream, creek, wetlands, estuaries, gulch, and ditch. Water is also stored on the surface in different types of water bodies such as lakes, lagoons, reservoirs, and ponds. Together, all of these flowing and stored surface water bodies are called **watercourses**. In contrast, the body of water stored beneath the surface of the ground is called **groundwater**.

Connectivity is a term that refers to the physical connection between tributaries and the river, between surface water and groundwater, and between wetlands and water sources. Roads can also be connected to the stream system when runoff flows along the road system before entering the stream network (also called “hydrologically connected road.”). In this manual, our goal is to disconnect roads from streams.

Stream Channels

- ◆ Stream channels carry runoff flows from precipitation in the watershed. The channel is carved by the flowing water . Bankful is defined as the typical flow that forms the shape of the existing channel. Most rivers reach bankful stage, at approximately a two-year reoccurrence interval. If the sediment load in a stream is greater than the stream’s capacity to move sediment, it becomes deposited in the stream channel, causing it to fill or aggrade. Too little sediment, compared to what the stream was historically carrying, can cause the channel to downcut or degrade in elevation. When either of these conditions happens, the stream channel must adjust upstream and downstream. Streambank erosion, channel widening, and headcut erosion are some of the symptoms of this readjustment.
- ◆ Stream crossings on roads, particularly bridges, can be seriously impacted by the changes in stream channel depth and width.

Stream Order

Stream channels connect like the veins on a leaf. This network of smaller tributaries flowing into increasingly larger streams, has several numbering systems. The stream “order” system refers to numbering tributaries starting in the headwaters.

1. First-order streams have no tributaries;
2. Second-order streams have only first order channels as tributaries, or they occur where two first-order streams come together;
3. A third-order stream is formed by the joining of two second-order streams, and so on.

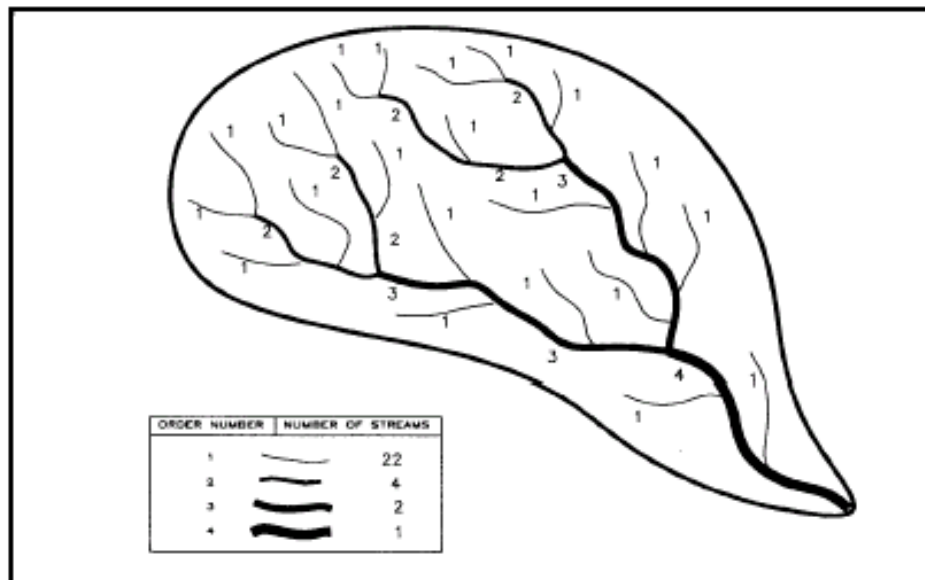

Figure 3.2 Stream order designation (Strahler 1957)

Stream Categories

Streams are often identified by their flow condition:

- perennial – those streams which carry water the year round, except for infrequent and extended periods of severe drought.
- ephemeral – streams consisting of a dry channel throughout most of the year, bearing water only during or immediately after a rain..
- intermittent – stream channels which carry water only part of the year and are dry the other part, but which receive flow from the groundwater table when it is high enough.

These stream types are indicated on topographic (“topo”) maps of the U.S. Geological Survey (USGS), with perennial streams identified by solid blue lines (“blue line streams”) and intermittent streams by dash-dot blue lines. However, these USGS map indications are only estimates made at the date of the original map development, and should not be used as a substitute for more accurate descriptions of current conditions – especially for smaller creeks.

Stream Class

Another way to categorize streams is by the water’s use, such as for aquatic species or domestic water supply. The terms below are also commonly used, particularly by the California Dept. of Forestry and Fire Protection (CDF) and the Dept. of Fish and Game (DFG) to help define the degree of state forestry regulations:

Class I Watercourse: A stream (or lake) that is used for a domestic water supply (including springs) on the site and/or within 100 feet downstream of the operations area; and/or fish always or seasonally present onsite, including habitat to sustain fish migration and spawning. (It typically flows year round, but may flow seasonally.)

Class II Watercourse: A stream (or lake) that has fish always or seasonally present offsite within 1000 feet downstream, and/or aquatic habitat for nonfish aquatic species; excludes Class III waters that are tributary to Class I waters. (These streams may flow year round or seasonally; many springs and wetlands are also included.)

Class III Watercourse: A stream channel (or lake) with no aquatic life present but showing evidence of being capable of sediment transport to Class I or II waters under normal high water flow conditions.

Class IV Watercourse: Man-made watercourses, usually downstream, for established domestic, agricultural, hydroelectric supply or other beneficial use.

Other stream terms are often based on legal definitions from one or more laws. The Clean Water Act refers to “Waters of the U.S.”, and “Ordinary High Water Mark”, both of which are defined under the Act in *Chapter 2 – Regulations and Permits*.

Flood Frequency and Floodplain Size

Floods are natural events and should be expected. Most rivers reach bankful stage, at approximately a two-year reoccurrence interval. Bankful is defined as the typical flow that forms the shape of the existing channel. While bankful flows are a common occurrence, catastrophic floods may occur any year. The

probability of occurrence of a particular size flood, based on the years of record, is often used to predict the frequency of floods for planning purposes. Potential frequency of 25, 50, and 100 year flood events are commonly used.

The overflow onto the floodplain makes this area part of the river system during larger storms. Floodplains occur in large river valleys and also in the valleys of creeks just a few feet wide, but are usually not present along most headwater tributaries. Structures that encroach onto this floodplain – such as roads and buildings – are encroaching on the stream’s ability to move laterally under higher flows, and may be damaged or destroyed when flows onto the floodplain occur. The “100-year floodplain” represents the area potentially inundated for an unusual but possible flood event with the probability of occurring once every 100 years on the average. This potential 100-year flood scenario is being used more and more for engineering designs for any structures within a stream channel or floodplain.

Flood Frequency & Size Concepts: (Mount, 1995)

1. The probability that a 100-year flood will strike a river in California is the same every year, regardless of how long it has been since the last 100-year flood.
2. It is not certain that the 100-year event will occur sometime in the next 100 years (although it is pretty likely).
3. In California, where historic data sets are small, the 100-year floodplain is likely to grow following a major flooding event.
4. It is a virtual certainty that the defined 100-year floodplain is not the actual 100-year floodplain.

WATERSHED PROCESSES

Understanding the physical processes that shape a watershed’s condition can help in making better decisions about road management practices. The quality of the stream and its fish habitat is directly influenced by these watershed processes.

Rainfall, Streamflow, and Runoff

- ◆ **Hydrologic cycle** is the term used to describe the continuous circulation of the Earth’s waters from the ocean, to the atmosphere, to the land, and then back to the ocean. **Hydrology** is the science of water, or the study of water and its environment in the hydrologic cycle. Water falling to earth, or **precipitation**, can be in the form of rainfall or snow. Rainfall or snowmelt entering a stream channel becomes stream flow.
- ◆ **Runoff** occurs when the ground in the watershed is no longer capable of absorbing the precipitation.
 - Some soils absorb water from rainfall more easily than others, so runoff occurs less rapidly.
 - Vegetation can affect the rate of runoff, with more runoff usually coming off bare areas.
 - Urban or paved areas speed the movement of water and shorten the time between rainfall and runoff. The effects of urbanization and deforestation can alter the hydrograph, increasing peak run-off flows in a watershed and increase chance or frequency of flooding.
- ◆ **Precipitation** affects runoff based on the following aspects:
 - Intensity of rainfall – measured in inches per hour – varies from low to high; high intensity rainfall leads to large amounts of runoff.
 - Duration of rainfall, together with intensity, affects the runoff – the longer the rain storm, the greater the amount of water to runoff.
 - Frequency of rain storms during a period of time – multiple storms over a short period of time create greater runoff than single storms or those spread out over a long period of time.

- Type of precipitation – rain or snow – controls the timing of runoff; snowpack spreads out the effects of storms, leading to delayed runoff in warmer months.

Geology and Soil Landscape

- ◆ **Geology** is the science of the earth. A more specific study is **geomorphology**, or the study of the physical features of the surface of the earth. Understanding the regional landscape of Central California requires reference to these sciences.
- ◆ Soils are weathered rocks mixed with other organic materials. The stability of soils in the region varies by type, and is closely associated with the qualities of their underlying rocks. Two soil types known for their high tendency for erosion are:
 - “Blue goo”soils in the Coastal Franciscan formation; these soils are derived from incompetent schist high in clay content and tend to act very “slippery” on steep slopes. Slopes composed of this type of soil are often hummocky and grass-covered.
 - Decomposed granite (or “DG”) soils; these soils do not stick together well (are “non-cohesive”) due to high sand and low silt and clay content.

Soil Erosion and Sedimentation

◆ Erosion Processes

- Soil erosion is mainly caused by water and wind.
- Erosion is a natural process linked to the hydrologic cycle.
- Not all soil that is eroded enters the stream or drainage system .Streams do work by eroding, transporting, and depositing material (silt, sand, gravel, cobbles, boulders). Examples of this process include streambank erosion, muddy streams, and new gravel bars

◆ Types of Erosion

- Gully – An erosion channel formed by concentrated runoff, usually larger than one foot deep and wide. Gullies often form where road surface or ditch runoff is directed onto unprotected slopes.
- Sheet & Rill – Sheet erosion is the loss of soil in thin layers of soil across a large surface area, while rill erosion is a small erosion channel (larger channels are called gullies). Rill erosion can be seen where rainfall and surface runoff is concentrated on unprotected fillslopes, cutbanks, and ditches.
- Dry Ravel – On steeper slopes, gravity can bring dry soil downhill. Frost heaves can create this condition also. Raveling is most obvious along bare, steep road cuts.
- Landslides - The downslope movement of a mass of earth caused by gravity. Examples include debris slides, torrents, rock falls, debris avalanches, and soil creep. They may be caused by natural erosional processes, natural disturbances (earthquakes, floods, fires), or human disturbances.

◆ Sedimentation

- Soil erosion that enters the stream channel or drainage system (ditches, storm water drains, etc.) becomes sediment.
- Natural levels of sediment in a stream system are referred to as “background levels”.
- Excessive levels of sediment are those amounts above background, and can cause habitat problems when pools and spawning gravels are filled with fine sediment.
- High levels of sediment suspended in the stream flow cause cloudy water, or turbidity. Persistent muddy appearance is usually due to high silt and clay content.
- Sediment becomes deposited in the stream channel when the flows slow down, such as in gravel or sand bars, pools, or other areas of the stream bed. Floods can cause sediment to deposit outside of the channel in the flood plain.

With land use activity, the natural background rate of erosion can be accelerated or result in chronic delivery of sediment to stream channels over many decades. Three geomorphic processes are responsible for most sediment delivery from upland areas. These are:

- Chronic surface erosion from bare soil areas
- Fluvial erosion, including gully and stream channel erosion
- Mass wasting or landslides

Understanding these processes is necessary to conduct successful upslope assessment and restoration. Most of these processes, once initiated, result in erosion of sediment, which transports to hillslopes or stream channels. Whether the sediment remains in storage either on the hillslope or within the stream channel depends on the sediment types, and the timing, magnitude and frequency of storm events within a region. Once sediment suspends in water, or is mobile within the stream bed, sediment becomes part of the “net watershed sediment yield.”

Vegetation

The type and extent of vegetation throughout the watershed affects the amount and pattern of storm runoff in the watershed and influences the amount of erosion that occurs.

Upland Vegetation

- Vegetation on the slopes helps to slow runoff, which allows better seepage of rainfall into the soils and groundwater and better water storage for summer streamflows.
- Plant roots hold soil in place, with deeper-rooted trees helping to prevent deep seated erosion like landslides.
- Plant litter, such as dead leaves, needles and branches, provides a protective layer over the soil from the erosive impacts of rainfall and snowmelt.
- Loss of vegetation, from fires, disease, logging, grazing, or urbanization, can increase soil erosion and increase the rate of runoff.

Riparian Vegetation

- ◆ Streams provide both surface and underground water to riparian vegetation.. Streamside vegetation provides many benefits to a healthy stream, such as:
 - Shade to the stream helps provides the cold water that salmonids need;
 - Food for fish from insects, leaf litter and organic material falling into the stream (also known as allocthanus material);
 - Protection from bank erosion through root strength;
 - Structure for instream habitat when trees fall into the stream (also known as Large Woody Debris, or LWD), which helps create scour pools and traps sediment for slow release during storms;
 - Filter or buffers from sources of surface erosion, thus minimizing instream sedimentation;
 - During floods, slows the energy of the flow and causes sediment to deposit in the floodplain instead of in the channel.
 - This narrow riparian plant zone offers habitat for many animal species dependent on its unique features.

Riparian Zone

The riparian zone borders the stream and is the transition area to the upper watershed. The zone interacts with the channel and bears strongly on the structure and function of the aquatic ecosystem. The structure and composition of the riparian zone can be affected by the stream type and its active channel, as well as by geologic and topographic features (Figure 3-3).

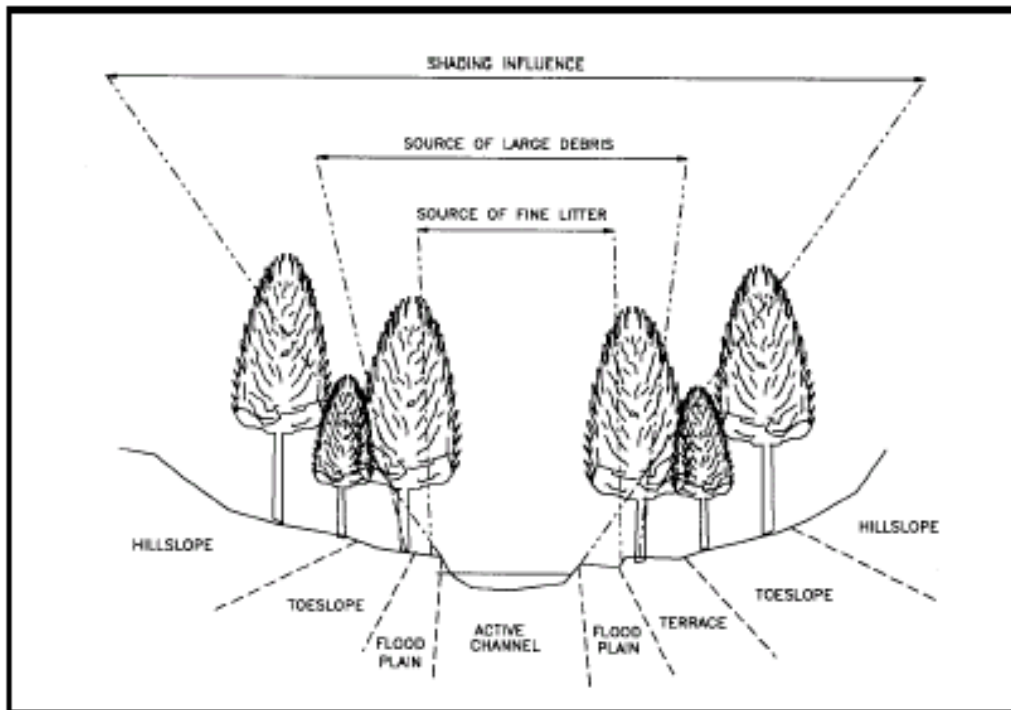

Functions of the riparian zone include:

- Controlling the amount of light reaching the stream which affects temperature and productivity.
- Providing litter and invertebrate fall.
- Providing stream bank cohesion and buffering impacts from adjacent uplands.
- Providing large woody debris.

Wetlands:

- ◆ These areas generally include, but are not limited to, marshes, bogs, estuaries, and similar areas. Some are near or directly connected to the stream channel system. They can also include manmade wetlands found in but not limited to ditches behind soil berms or shallow excavations. If a wetland area is encountered while working in the field, the appropriate regulatory agencies must be contacted.
- ◆ Wetland plants aid in trapping sediment and filtering excess nutrients, which can improve water quality.
- ◆ Wetlands help slow floodwaters and function to recharge groundwater areas or aquifers.

- ◆ Many wildlife species are dependent upon wetlands for their habitat.

WATER QUALITY

Clean water means good water quality. Water quality is not so good, for example, when a stream is too muddy (or turbid) or too warm to support the natural and human uses dependent on the water. These natural and human uses are termed “beneficial uses” and include recreation, drinking water, and cold water for salmon fisheries. Control of the sources of water pollution is a major focus of state and federal laws.

Types of Water Pollution

Pollution from sewage and industrial wastes – usually entering the water from pipes – is known as point source pollution. Runoff or indirect pollution – from a variety of less obvious sources – is called nonpoint source (NPS) pollution. Rural roads and road maintenance activities have the potential to contribute to nonpoint pollution, the major type of water pollution problem in California today. Road maintenance yards and other “industrial” type facilities, if not managed well, can be the source of runoff or “storm water” pollution and even hazardous waste contamination of the surface (stream) and ground waters.

Water Quality Protection and Improvement

A watershed approach looks at both point and non-point sources of pollution and looks for solutions across all land ownerships. Ways can be found to prevent, reverse, and eliminate damage caused by both types of pollution. Sometime the solutions, especially for nonpoint runoff sources, need to be quite creative as the traditional pollution treatment plants will not work. Prevention is always the first and best approach, and the cheapest.

Water quality protection laws and programs seek to prevent pollution or to clean it up. For this region, water quality objectives are set, and beneficial uses are stated for each water body in the Regional Basin Plans adopted by the Regional Water Quality Control Boards (RWQCB) and the State Water Resources Control Board (SWRCB). These objectives relate to many water quality factors, such as: temperature, sediment, turbidity, oil and grease, bacteria, toxicity, pesticides, and specific chemicals.

Finding cooperative ways to protect and restore watershed health among all of the owners and users of a watershed is becoming a common aspect of the “watershed approach”. Community-based watershed groups form and seek common solutions to the watershed’s problems. Often, a watershed assessment of the current and historic conditions is performed, followed by a jointly prepared strategy or plan for solving identified problems. For county road issues, this cooperative approach can be of benefit when other road ownerships are part of the problem or when non-county upslope or upstream sources create erosion or runoff problems on county roads

TMDLs – Coming to a River Near You!

TMDL = Total Maximum Daily Load = pollution limits by stream and by pollutant type

When a river does not meet state and federal water quality standards, it usually becomes earmarked for a remedial strategy under the federal Clean Water Act. The state has identified streams that are polluted with various pollutants. This list of “impaired water bodies” was adopted by the State Water Resources Control Board and the Regional Water Quality Control Boards in 1998 and is referred to as the “303(d) list”, which refers to a section of the Clean Water Act. Also mandated by the act is the establishment of Total Maximum Daily Loads (TMDLs) as a means to address each pollutant.

The amount and sources of each pollutant are identified, and a strategy is developed for restoring the stream to state standards. Since roads are a known source of sediment, each of the sediment TMDLs will be addressing limits to the amount of erosion and sediment that will be allowable from roads: both public and private. The methods will be outlined in an Implementation Plan. Getting ahead of the curve in meeting this challenging regulation will benefit counties and county road managers.

HELPFUL REFERENCES

- Alt, David and Donald W. Hyndman. (2000). Roadside Geology of Northern and Central California. Mountain Press Publishing, Missoula MT. [\$20.00]
- California Department of Fish and Game (2002) California Salmonid Stream Habitat Restoration Manual. Flosi et al. (www.dfg.ca.gov)
- California Division of Mines and Geology. “Geologic Hazards”, “Geologic Mapping”, “Watersheds Mapping”. (www.consrv.ca.gov/dmg)
- Leopold, Luna B. (1994). A View of the River. Harvard University Press. Cambridge, MA.,298 pp. [@\$35.00]
- Leopold, Luna B. (1970). Water, Rivers and Creeks. University Science Books. Sausalito, CA. 185 pp. [@\$25.00]
- Mount, Jeffrey. (1995). California Rivers and Streams. University of California Press. Berkeley, CA. 359 pp. [@\$22.00]
- National Association of Counties (NACo). (1999). “Leadership in Watershed Management: The County Role.” NACo Watershed Management Advisory Committee. (www.naco.org)
- National Marine Fisheries Service. (1996). “Factors for Decline: A Supplement to Notice of Determination for West Coast Steelhead Under the ESA”. (www.nwr.noaa.gov)
- Oregon Watershed Enhancement Board (OWEB). (1999). Oregon Watershed Assessment Manual. Salem, OR. (www.oweb.state.or.us/publications)
- Spence, B. et al. (1996). “An Ecosystem Approach to Salmonid Conservation.” ManTech Environmental Technology. Prepared for NOAA Fisheries. (www.nwr.noaa.gov)

CHAPTER 4

STREAM HABITAT AND SALMON FISHERIES

Chapter 3 described the basics of how actions within watersheds affect water quality and stream conditions. In this chapter the focus is on the fish populations within our watersheds – primarily salmon and steelhead. Understanding what the fish need in terms of water quality and habitat in our county’s streams, will help to understand why performing better road maintenance practices is so important.

- ◆ Salmon & Steelhead Life Cycles
- ◆ Salmon & Steelhead Habitat Needs
- ◆ Fish Passage
- ◆ Threatened and Endangered Status
- ◆ Other Aquatic or Riparian Species of Concern

SALMON & STEELHEAD LIFE CYCLES

More than one species of fish in the salmon and trout family are presently of concern due to their dwindling numbers in our region’s streams. These species are referred to by biologists as salmonids.

Common Name	Genus & species
➤ Coho (“Silver”) Salmon	<i>Oncorhynchus kisutch</i>
➤ Chinook (“King”) Salmon	<i>Oncorhynchus tshawytscha</i>
➤ Steelhead (Rainbow) Trout	<i>Oncorhynchus mykiss irdedeus</i>

Salmon and steelhead are born in freshwater river systems, then move to the ocean to live, feed and grow as adults, finally returning to their native stream to reproduce or spawn (Figure 1-1). This river-to-ocean- to river life cycle makes them **anadromous** fish. Their life cycles are opposite that of **catadromous** fish , which are species that are born in the ocean, migrate to live in fresh water as adults, finally returning to the salty sea to reproduce. Both anadromous and catadromous fish are amazing in their ability to undergo the physiologic changes necessary to adapt to salt and fresh water chemistry.

Important Life Cycle Terminolgy

Anadromous (a-nad’-ru-mus) - Born in freshwater, anadromous fish return to the sea to grow to mature adults, returning to their natal stream to reproduce once again.

Spawn- the act of creating a nest or “redd” in a gravel bed and subsequent mating between a mature or “ripe” female and often more than one male.

Alevin- the first stage of emergence from the egg into the gravel redd, with a yolk sac attached.

Fry- the young fish that emerges from the gravels after two weeks.

Juvenile- the period of time the young fish spends in fresh water until migrating out to sea.

Smolt- the transformation stage as the juvenile fish prepares tomigrate from fresh to salt water.

Table 1-1 gives the range of months when these species can be found in our streams. Besides their spawning period, the fish use the stream for months to years during the juvenile rearing stage.

Table 1-1. Salmon Life Cycles in Central California Coastal Streams

Species	Spawning	Rearing	Out-Migration	Time in Freshwater
Chinook Salmon				
Fall-run	Sept - Feb	all year	Mar - Sept	1- 15 months
Spring-run	mid Sept – mid Oct	all year	April - Oct	1 – 15 months
Coho Salmon	Oct - Mar	all year	Mar - May	1+ yr
Steelhead				
Winter-run	Nov - June	all year	Mar - Nov	1+ to 2 yrs
Summer-run	Mar - June	all year	Mar - Nov	1+ to 2 yrs

1/ Sources: Ross Taylor, consultant; Al Olson, Klamath National Forest; Greg Bryant, NMFS

¹Coho salmon (*Oncorhynchus kisutch*)- Adult coho begin to appear in the streams after the first substantial autumn rains, typically in early December through mid-January. Watch the beaches along the coast to see if the summer sand bars have been broken through by downstream river flows, allowing the fish access to upstream reaches. Avoid a trip immediately after a rainstorm due to decreased visibility from sedimentation and turbidity. Female coho are locked into a three year return, which is the time between hatching, spending a year in freshwater, out-migrating to the ocean for two years, and returning to their natal stream as a mature adult to spawn. The males return to the river as both two (jacks) and three year olds.

When returning to spawn, as soon as their bodies hit the fresh water, physiologic changes begin to happen, including the break down and disintegration of the membrane sac surrounding the eggs. This process also plays a part in the disintegration of their bodies and you will most likely observe white patches of soft disintegrating flesh on the salmon that you see- one of the factors that make coho easier to spot than steelhead. They are not feeding during migration and spawning, and when spawning is over, their lives are also. As the run progresses, you can typically see coho carcasses along the sides and bottom of the river.

While spawning, the adult female can be seen making a redd (gravel nest) with the swishing action of her body and tail. She is cleaning the gravel over which she will spawn and release her eggs, followed by fertilization by the male over the redd. Look for thrashing activity and indentations in the riffles. Sedimentation in the gravel reduces survival rates by depriving the eggs and newly hatched fish (*alevin*)

¹ Kull, K.M. (1999) A Guide to Observing Salmonid Spawning and Migration Within the Central California Coastal Counties; based on information from Central Coast DFG biologists and others.

of needed oxygen and prohibiting the necessary flushing of waste products from the redd. The eggs incubate for approximately six to eight weeks. Warmer temperatures may speed this process. After hatching, the *alevin* stay in the gravel for another two weeks with their yolk sacs attached. At this stage they are *fry* and will remain in freshwater for about 14 months before out-migrating to the sea between March and early June. During this first 14 month stage of life, known as the “juvenile rearing” period, it is critical that the stream habitat provides an adequate food supply, calm water areas for protection from torrential downstream currents, shelter from predators, and deep pools of cool water refuge during hot summer months.

Steelhead trout (*Oncorhynchus mykiss*) - Steelhead, after spending their first few years in the freshwater stream system where they hatched, migrate out to sea during late spring as adults. After a typical one year plus in the saltwater, they return to the river to spawn arriving after the first big rains, typically in Jan.-Feb. through May. The female adults are on average three to four years old and the males approximately three years old.

The female steelhead, similar to the coho salmon, makes a redd typically in the shallow riffle gravels at the tail end of a pool. The eggs that are deposited and fertilized in the redd will incubate for approximately six to eight weeks - the rule of thumb is approximately 50 days at 50 degree temperatures and warmer temperatures may speed this process. After hatching the *alevin* stay in the gravel for another two weeks with their yolk sacs attached, are approximately 3/4” long and are extremely vulnerable. After this stage they are considered *fry* and will remain in the protection of the river system for one to three years before migrating to the sea between March and early June.

After spawning, the females tend to return immediately to the sea, while the males stay in the freshwater system through much of the winter and early spring. During their prolonged time in the stream, the males are not feeding and are susceptible to disease, fungus infections, predation, turbidity problems and fighting, all factors that contribute to a much higher mortality rate for male steelhead over females. The steelhead that do survive may return to the freshwater repeatedly to spawn; a record nine year old steelhead was recently observed in the Carmel River. Steelhead can be more difficult to spot than coho because they are darker in color, do not develop the white patches of disintegrating skin, are more wary of predators than coho (having future life cycles to survive), and run during the most turbid, high water time of the year.

Chinook salmon (*Oncorhynchus tshawytscha*)- Chinook salmon are found from Northern Alaska to Central California on the North American coast and from Northern Japan to the Bering Sea on the east coast of Asia. The spawning populations in the Sacramento-San Joaquin Rivers are the southernmost range of the species, and the Sacramento River and its tributaries is the only system in the world that supports four separate races or runs of chinook which use the system for spawning year round; the fall, late-fall, winter and spring runs. Chinook are larger fish than coho and tend to be found in the bigger river systems, often spawning in the mainstem of those rivers. In our coastal region, the best places to see chinook are within the Russian River system or in the Lagunitas Creek system, after they enter the river in the fall to spawn primarily in the mainstem. Look for chinook at the hatcheries on the East Fork of the Russian River and at Warm Springs beginning in November-December. Adult spawning behavior is similar to coho but the residence time of the newly hatched fish in the stream is much shorter- the chinook fry, after only a few months in the river, will outmigrate to the sea in the spring. While coho and steelhead maximize their survival by prolonged rearing time in freshwater, chinook maximize their survival of the species by laying an enormous number of eggs per fish. In our region, Chinook stay out at sea for one to three years before returning to the river to repeat the cycle all over again. In famous rivers in Alaska such as the Kenai, Chinook salmon spend five years at sea, returning to spawn at record breaking, trophy winning sizes.

SALMON AND STEELHEAD HABITAT NEEDS

- ◆ **Access** to stream habitat – upstream for adults and up and downstream for juveniles
- ◆ **Clean gravels** in riffles and runs where adults can build nests (redds) in which to lay their eggs, juveniles can rear, and stream insects (macro-invertebrates) can produce to provide food for the fish
- ◆ **Pools** that are cool and deep where young can rear and adults can rest
- ◆ **Instream shelter** (created by large woody debris (LWD), boulders, undercut banks) where fish can hide from predators or avoid being swept downstream
- ◆ **Overhead cover** to provide shade and sources of insect food
- ◆ **Sidechannels and smaller tributaries** for over-wintering use
- ◆ **Cool, flowing water** free of pollutants, with good clarity, and sufficient dissolved oxygen
- ◆ **Estuary space** , where salt and fresh water mix, for adjustment by adults moving upstream, and juveniles (smolts) moving into the ocean

Another way to look at salmon habitat needs is to remember the “**Four C’s**”:

- **Cold**
- **Clean**
- **Complex**
- **Connected**

COLD: Water that is too warm (>60° F) for a prolonged time can be stressful to the health of these coldwater fish, while water that is too hot (>73-79° F) will kill them.

CLEAN: Water, pools and gravels should be clean and not be polluted from excess sediment or nutrients or any chemicals.

COMPLEX: A stream should not be cleaned or altered significantly of its naturally complex structure, such as large wood, overhanging riparian vegetation, meanders, flow patterns, and floodplain connections.

CONNECTED: Fish must be able to get from the ocean to their spawning areas and juveniles to the ocean, with no manmade, impassable barriers preventing this migration.

FISH PASSAGE

Salmon and Steelhead Location in the Watershed

Salmon and steelhead use stream systems from the top to the bottom. Adults will go up as high in the system as they can physically reach, which depends upon the species. Steelhead are able to navigate steeper gradient streams and can go higher up in the drainages than coho. Steelhead can also use streams that only flow seasonally (winter and spring) during a part of their life cycle. Chinook salmon tend to spawn in the mainstem of larger, lower gradient rivers such as the Russian River.

Salmon and steelhead are powerful jumpers and can ascend many potential barriers as long as there is a pool of sufficient depth below the jump and a place of slow water to rest between a series of jumps. If a barrier is too high to jump or there is not a deep pool directly below it, salmon and steelhead will often repeatedly attempt to overcome it until they become exhausted or die trying; when water velocity is too great or the

amount of flow is too low, mortality can also occur.

The table below (from Taylor, 2000) displays minimum water depth requirements and recommended swimming and leaping abilities for several salmonid species and lifestages commonly found in California.

Table 1-2. Depths and swim speeds (adapted from NOAA Fisheries, 2000; and Moyle, 1986)

Species or Lifestage	Minimum Water Depth	Prolonged Swimming Mode		Burst Swimming Mode		
		Maximum swim speed	Time to Exhaustion	Maximum swim speed	Time to Exhaustion	Maximum leap speed
Adult Chinook, Coho, and Steelhead	1.0 feet	6.0 feet/sec	30 minutes	10 feet/sec	5.0 sec	3.0 feet/sec
Coastal Cutthroat trout and Rainbow trout	0.5 feet	2.5 feet/sec	30 minutes	5.0 feet/sec	5.0 sec	5 feet/sec
Juvenile Coho salmon and Steelhead	0.5 feet	2.0 feet/sec	30 minutes	12 feet/sec	5.0 sec	3 feet/sec

Typical passage problems (from Taylor 2000) created by undersized, improperly installed, or poorly maintained stream crossings are:

- ◆ Excessive drop at outlet (entry leap is too high for fish)
- ◆ Excessive velocities within culvert
- ◆ Lack of depth within culvert
- ◆ Excessive velocity or turbulence at culvert inlet
- ◆ Debris accumulation at culvert inlet or within culvert barrel

Barriers may occur as temporal, partial or total depending upon flows and timing. The following table (from Taylor 2000) defines the type of barriers, based on these variables.

Table 1-3. Definitions of barrier types and their potential impacts.

Barrier Category	Definition	Potential Impacts
Temporal	Impassable to all fish based on run timing and flow conditions	Delay in movement beyond the barrier for some period of time
Partial	Impassable to some fish at all times	Exclusion of certain species and lifestages from portions of a watershed
Total	Impassable to all fish at all times	Exclusion of all species from portions of a watershed

Barrier Forms:

- 1) Physical Barriers (too tall or long)
- 2) Flow Barriers (too little, too fast)
- 3) Thermal Barriers (too hot)

Types of Physical Barriers:

- ◆ Natural waterfalls
- ◆ Water diversion dams and weirs (without fish ladders)
- ◆ Flood debris dams (without fish ladders)
- ◆ Water storage dams (without fish ladders)
- ◆ Landslides in stream ⇐ SOMETIMES ROAD-RELATED
- ◆ Culverts & other types of stream crossings ⇐ ROAD-RELATED

When are they barriers?

- ◆ Seasonally, during low – or very high - flow periods
- ◆ Temporarily – if alteration is not completely successful
- ◆ Permanently – if not altered

Sources of Information on Local Salmon Habitat & Barrier Locations

Not all of the streams crossed by County roads provide habitat for salmon and steelhead. Some may have natural barriers while others may be too steep for upstream migration. If you want to know specific stream areas used by salmon and steelhead, here are some useful references:

- 1) Stream Crossing Inventory and Fish Passage Evaluation; conducted for the counties of Mendocino, Sonoma, Marin, San Mateo and Santa Cruz by Ross Taylor & Associates. Available at each county DPW/DOT.
- 2) NOAA Fisheries Salmon & Steelhead Habitat Distribution Tables – by County & Stream – website (<http://swr.nmfs.noaa.gov>)
- 3) California Dept. of Fish and Game (DFG) Fishery Biologists & Wardens – each county.
- 4) Recovery Strategy for California Coho Salmon; Department of Fish and Game, 2004.

NOTE: Upper reaches of streams may still be home to other coldwater fish, such as resident rainbow trout, as well as other sensitive aquatic species. Barriers to migration may not be their problem, but clean water is still needed.

Common conditions that block fish passage. (California Salmonid Stream Habitat Restoration Manual; Chapter IX, California Dept. of Fish and Game, Flosi et. al 2002.)

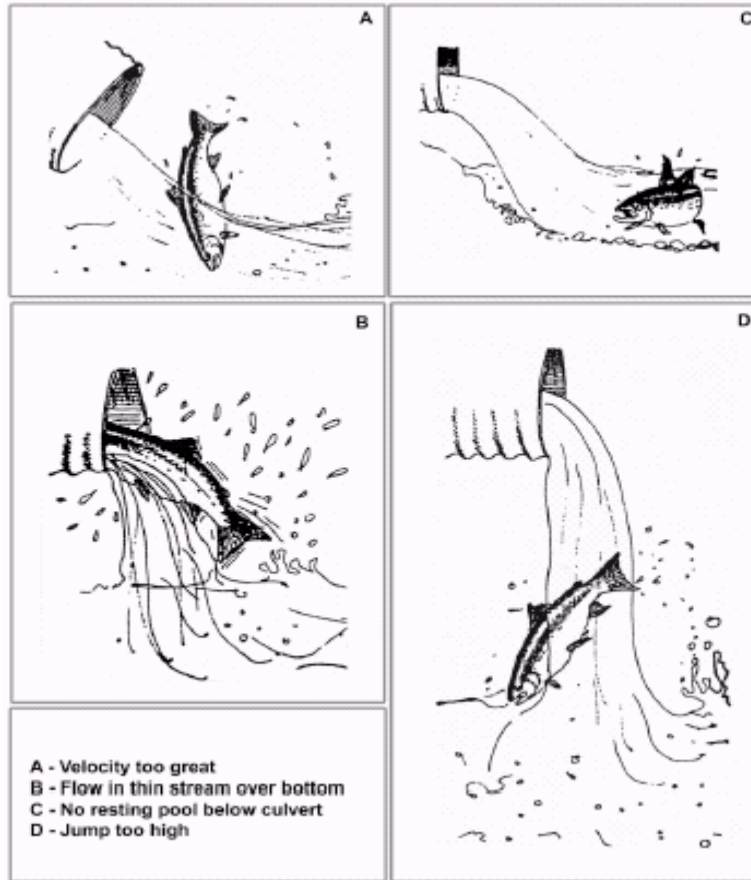

ESUs AND THREATENED OR ENDANGERED STATUS

Not all salmon and steelhead populations are identical when it comes to being listed as “threatened” or “endangered” under the federal Endangered Species Act (ESA). NOAA Fisheries adopted the concept of an ESU- “Evolutionarily Significant Unit” to define distinct population segments of anadromous salmonids, based on genetic similarities. Populations of genetically similar fish get listed together in an ESU. The intent is to conserve the genetic diversity of these species and the ecosystems they inhabit.

Table 1-4. Status of ESA Listings of Salmon & Steelhead in Coastal California

Species/ESU	Federal Listing ²	State Listing	ESU Area
COHO SALMON			
Central Calif. Coast	Threatened, with a pending recommendation for upgrade to endangered status. (2004)	Listed as endangered from SF to Punta Gorda. (2002). Listed as endangered in San Mateo and Santa Cruz. (1995)	Punta Gorda south to San Lorenzo River (Santa Cruz)
So. Oregon / Northern California (SONCC)	Threatened	Listed as threatened from Cape Mendocino north to Oregon border. (2004)	Punta Gorda north to Elk River, OR. Includes Klamath & Trinity Basins
CHINOOK SALMON			
California Coastal	Threatened		Redwood Creek (Humboldt) south to and including Russian River basin (Sonoma).
Southern Oregon / Northern California (SONCC)	Not listed		Cape Blanco (Oregon) south to lower Klamath R. downstream of Trinity River
STEELHEAD			
Central Coast	Threatened		Russian River (Sonoma) thru Aptos Creek (Santa Cruz).
South Central Coast	Threatened		Aptos Creek (Santa Cruz) -San Luis Obispo
Northern Calif. Coast	Threatened		Redwood Cr.(Humboldt) through Gualala River (Sonoma).

² Species status updates can be found at NOAA Fisheries website: [//www.nwr.noaa.gov](http://www.nwr.noaa.gov)

OTHER AQUATIC OR RIPARIAN SPECIES OF CONCERN

Working within seasonal restrictions for other listed species is a concern when conducting road maintenance projects and fisheries restoration projects. See *Appendix A- Seasonal Planning BMP* to view calendar restrictions for listed species including coho salmon, chinook salmon and steelhead trout, red-legged frogs, northern spotted owl, Least Bell's Vireo, marbled murrelet, and the willow flycatcher .

Another designation used by Fish and Game is California Special Concern species (CSC): these species have declining population levels, limited ranges, and/or continuing threats that have made them vulnerable. There is also a Federal Special Concern (FSC) species list. Some of these species may soon reach the point where they meet the criteria for listing as threatened or endangered under the State and/or Federal Endangered Species Acts. Lists of these Species of Concern should be available through your county planning department. Whenever you are in doubt about a project's impact on an animal or plant species that is on this list- consult a local agency biologist for advice on avoiding impacts to these critters.

HELPFUL REFERENCES

California Department of Fish and Game (2002) California Salmonid Stream Habitat Restoration Manual. Flosi et al. (www.dfg.ca.gov)

National Marine Fisheries Service. (June 2000). A Citizen's Guide to the 4(d) Rule for Salmon and Steelhead on the West Coast.

National Marine Fisheries Service. (1996). "Factors for Decline: A Supplement to Notice of Determination for West Coast Steelhead Under the ESA". (www.nwr.noaa.gov)

Spence, B. et al. (1996). "An Ecosystem Approach to Salmonid Conservation." ManTech Environmental Technology. Prepared for NOAA Fisheries. (www.nwr.noaa.gov)

Guide to Observing Salmonid Spawning and Migration Within the Central California Coastal Counties

A few important tips:

- Please *do not walk in* any of these streams, even to cross them. The fish spawn in the gravels of the shallow riffles (typically the best places to cross) and their redds (gravel nests) can be disturbed or ruined by trampling. This can be avoided in all of the places listed by walking along the stream, along a road adjacent to the stream, or looking down on the stream from a crossing or bridge.
- Note that this is only a partial list of the spawning and migration streams, selected for their accessibility. Many other streams within our region flow through private property and the access at road crossings would not be suitable for viewing fish.
- Additionally note that poaching is a potential problem in all of these streams, so discretion when viewing and interacting with the public is appreciated.
- Last but not least- dress for the cold! Many of these runs are down in the shade and cool dampness of the redwood forest.

Best Salmon Runs to Visit on the Central California Coast:

East Fork of the Russian River- In Ukiah at the Coyote Dam egg taking and imprinting facility. The dam sits on the east branch of the Russian River and forms Mendocino Lake. Look for steelhead, chinook and some coho salmon. Best time for chinook is Nov-Dec, but the facility is probably open from Nov through April.

Warm Springs Hatchery, off of Dry Creek Rd. west of Healdsburg in Sonoma County. The hatchery is located at the Warm Springs dam facility on Dry Creek and is an excellent place to see a mixture of wild and hatchery chinook, coho, and steelhead close-up; both adults and juveniles. For the convenience of visitors the hatchery follows a fixed schedule. Call Lake Sonoma Visitor Center (707-433-9483) to find out when they are open.

Mill Creek along Mill Creek Rd. in Sonoma County (west of Healdsburg) has a fairly strong run of both coho and steelhead but the viewing is not great. All the property along the road is privately held and trespassing down the banks to the creek's edge is not encouraged.

Mark West Creek intersection with St. Helena Rd. Traveling east from Santa Rosa look for steelhead from the St. Helena Rd. bridge approximately 1 mile after St. Helena departs from Calistoga Rd. There is a small waterfall here that the fish have to jump. The best time is just after a storm when the water is still a little high. Be careful, parking is not great.

Lagunitas Creek- The best place in Marin County to see coho salmon is in Lagunitas Creek at Samuel P. Taylor State Park on Sir Francis Drake Blvd. Walk down the hill behind the ranger station and kiosk. Another great place is between Shafter Bridge and Peters Dam, on Lagunitas Creek immediately east of Samuel P. Taylor State Park. Park in the Leo Cronin Memorial fish watching place at the east end of S.

P. Taylor State Park and walk up the service road toward the dam on the west side of the creek. This area can be spectacular at times.

San Geronimo Creek in San Geronimo Valley at Roy's Pools. Take San Geronimo Valley Drive south off Sir Francis Drake at the west end of the golf course and bear to the left. Stop at the bridge and look over the upstream side toward the golf course. During and just after a storm fish can be seen jumping into the fish ladder and trying to go over the remains of the old dam. This area has recently been restored by a huge community effort to improve fish passage, creating a series of beautiful jump pools for the fish. Great viewing spot!

Redwood Creek in the Muir Woods National Monument- Also a good place to observe coho salmon, Redwood Creek is located in southern Marin County. Take the Stinson Beach exit from Highway 101 just north of Sausalito and take Highway 1 west following the signs for Muir Woods National Monument, about 15 minutes off of Highway 101.

San Pedro Creek- Located in San Mateo County south of Pacifica. Look for steelhead spawning in the headwaters of the creek in the county park.

Mill Creek, tributary to Pilarcitos Creek- This is a more remote tributary to Arroyo de Leon Creek which then flows into Pilarcitos Creek. Mill Creek can be accessed from Burleigh Murray State Park on Higgins Canyon Rd. out of Half Moon Bay. Hike to the creek located approximately one mile from the parking lot. The remainder of Pilarcitos Creek runs through private property and trespassing is discouraged.

San Gregorio Creek- While this creek has both steelhead and coho salmon, most of the land is privately owned and trespassing is discouraged.

Pescadero Creek - A great place to look for steelhead because of the relative ease of access through Memorial and Pescadero Creek County Parks and Portola State Park. Fish are visible for a long distance along the mainstem of the creek. Coho have been sighted in Pescadero Creek but are rare and hard to observe.

Peter's Creek and Slate Creek- Located in Portola State Park you can observe steelhead spawning on both of these tributaries.

Gazos Creek- A great coho spawning stream with a long distance of mainstem to watch fish. Heading south on Highway 1 towards Santa Cruz from Half Moon Bay look for the old Gazos Creek gas station and turn left up into the coastal mountains. The road winds up into the watershed and follows the stream for quite a distance. Please do not walk down into the active creek channel but remain on the road looking down on the creek. A pair of binoculars might help here.

Waddell Creek in Big Basin State Park- Definitely the most reliable and best place to observe salmonid spawning in Santa Cruz County. Located approximately 15 miles north of the town of Santa Cruz on Highway 1. Find parking in the large beachside parking area, typically filled with windsurfers catching amazing rides on offshore waves. Crossing the highway walk up the Waddell Creek-Big Basin Road approximately 1.5 miles at which point you can hike over to and along the creek looking for fish for the next 2.5 miles, (between road miles 1.5-4.0). A beautiful hike all around.

Scott Creek- While a great spawning creek, most of the watershed is held in private land ownership and

trespassing is discouraged. Occasionally fish can be seen from road crossings. The Monterey Bay Salmon and Trout Project operates a hatchery located in the watershed at 324 Swanton Road (coming from the north, access Swanton Road a short distance south of Waddell Creek). Hatchery staff and volunteers conduct periodic searches for both coho and steelhead for both inventory and brood stock purposes.

San Lorenzo River in Santa Cruz- Look for steelhead migrating up through the mainstem heading for spawning grounds higher in the watershed. High flows prohibit spawning along most of the mainstem until approximately Boulder Creek. Migrating steelhead may be spotted in Henry Cowell Park, approximately 6 miles Empire Grade Road from Santa Cruz. Fall Creek, Zayante Creek, and Boulder Creek, all tributaries to the San Lorenzo River offer limited access for coho and steelhead spawning observations. Other fish bearing tributaries are located on private lands and trespassing is not recommended.

Soquel Creek in the Soquel Demonstration State Forest - Look for steelhead in the upper five miles of the creek within the Soquel Demonstration State Forest in Santa Cruz County. The forest is open to the public with nice walking areas from which to view steelhead. You cannot enter from the town of Soquel but should instead look to enter from the headwaters through Highland Dr. in Corralitos.

Aptos Creek in Nisene State Park- Leaving the town of Aptos you can drive part way in past the park kiosk. In winter the road to the upper watershed is closed to cars and hikers and bicycles take over making this a great family style walk. The road and trails run fairly close to the creek. Dress warmly.

Pajaro River - While most of the Pajaro system is in private ownership there may be steelhead to observe from the county park on Uvas Creek in the Santa Clara Valley.

Arroyo Seco Creek, tributary to the Salinas River- This is a great creek for access because it is on US Forest Service land. You can see steelhead in the late spring (April) if the fish ladder is functioning properly. The runs occur later in the year due to the high flows during the earlier winter months.

Carmel River - Most of the land within this watershed is in private ownership and trespassing is discouraged. Los Padres dam plunge pool is viewable from a public bridge across the spillway, pretty good for the mobility-challenged, and about the only place south of San Francisco that you can see dozens of adult steelhead.

Big Sur River in Andrew Molera and Julia Pfeiffer State Parks- An excellent and spectacular place to look for both migrating and spawning steelhead. The lower 6 miles of the river runs through the beautiful lower meadows of Andrew Molera State Park where migrating fish can be easily observed because of the clear water and open access. Spawning can be observed higher in the watershed in Pfeiffer State Park, where the flows are not as great.

Big Sur River off of Highway 1- Driving down the highway south of Andrew Molera State Park you can park at Gates 10, 9, 8 etc... which are California State Park public access gates to the Big Sur River. Walk down to a point where you can look down into the creek. A great place to look for spawning later in the spring.

CHAPTER 5
ROAD MAINTENANCE

5.1 Road Treatment and Design Principles.....5-3

5.2 Paved Road Surfaces.....5-23

5.3 Unpaved Road Surfaces.....5-27

5.4 Shoulder Maintenance.....5-33

5.5 Roadside Ditches.....5-37

5.6 Drainage Systems.....5-43

5.7 Street Surface Cleaning.....5-47

5.8 Concrete Work.....5-49

5.9 Snow and Ice.....5-51





5.1 ROAD TREATMENT AND DESIGN PRINCIPLES

GOALS OF TREATING COUNTY ROADS

In treating maintenance and design problems on county roads, our goals are to:

- ✓ Prevent or minimize delivery of sediment and chemicals to streams.
- ✓ Prevent or minimize the interruption of natural hillslope and stream runoff patterns.
- ✓ Protect aquatic and riparian habitat.
- ✓ Restore and/or provide access for adult and juvenile fish migration on all salmon and steelhead streams.

To accomplish this goal, we need:

- ✓ Solutions based on treating the causes of erosion and sediment delivery
- ✓ Low impact solutions that protect water quality
- ✓ Low cost, effective solutions
- ✓ Permanent, low maintenance solutions

INTRODUCTION

Watersheds and streams have a natural background rate of erosion that can be substantially increased by human activities. Delivery of eroded sediment to stream systems occurs through various transport processes that operate in all watersheds. Natural erosion and sediment delivery varies from relatively low amounts in stable watersheds underlain by resistant rock types, to comparatively high amounts in watersheds that have soft rock types that erode more easily. During large storm events or extremely wet winters, mass wasting or landsliding, large-scale gully erosion, stream crossing failure, and stream bank erosion are more likely to occur. Between large storm events or during poor water years, erosion rates are generally lower and overall sediment delivery is low, although sediment may still enter the stream from various erosion processes, particularly associated with road and inboard ditch drainage practices.

Native anadromous salmonids have evolved and successfully adapted through eons of time to changing stream habitat conditions produced by storms, floods and natural geologic events within this dynamic environment. However, excessive man-caused sediment delivery can combine with natural sediment production and delivery to streams to cause both impacts to water quality, as well as deleterious effects on anadromous salmonids by filling in pool habitat and embedding spawning substrate. Roads are often singled out in the sediment assessment process and in water quality investigations for



several reasons. Roads are typically a common and disproportionately significant source of accelerated sediment delivery in managed watersheds. Fortunately, most significant and common erosion problems occurring along roads can be predicted and cost-effectively prevented or treated.

EROSION AND SEDIMENT DELIVERY

Roads accelerate the natural background rate of erosion. They are subject to failures and severe erosion during large, infrequent storms, as well as chronic surface erosion every time it rains and runoff occurs. Three processes are responsible for most erosion from roads:

- *Chronic surface erosion* from bare soil areas including unpaved road beds, turnouts, road ditches, and road cutbanks – any bare soil is subject to surface erosion during rainfall and runoff events;
- *Fluvial erosion*, including gullying, erosion of stream crossings and stream bank erosion, that results in the direct delivery of eroded sediment to stream channels;
- *Mass wasting or landsliding* on road cutbanks and fill slopes, which may deliver sediment to a stream, but almost always interferes with traffic flow and public safety.

A portion of this eroded sediment is delivered to stream channels, either directly when a stream bank collapses into a stream, or indirectly when eroded sediment is carried by runoff through ditches, drains or gullies before being discharged into a stream channel (Figure 1). Eroded sediment that is not delivered to a stream is either permanently stored, or stored temporarily until the next storm takes it away and delivers it to a stream.



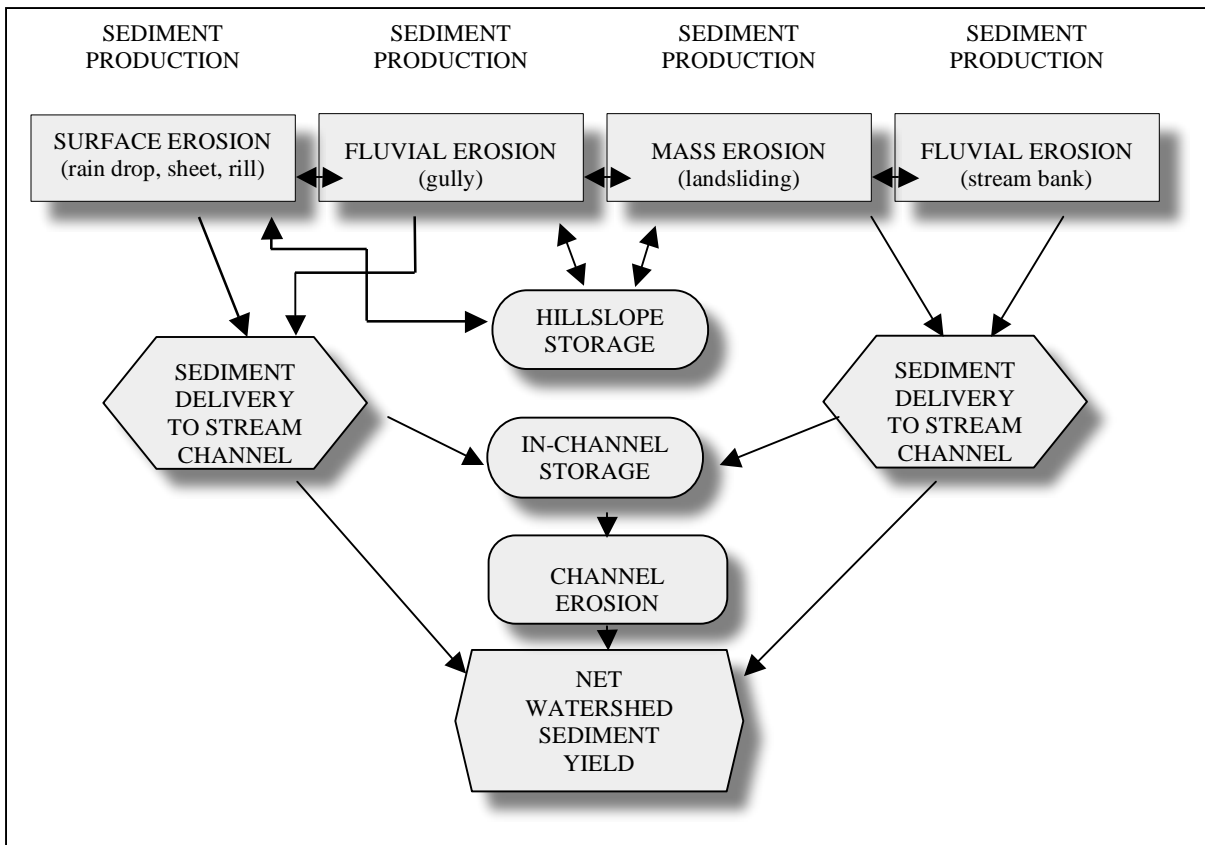

Figure X-1. Flow chart of erosion and sediment delivery to stream channels.

Recognizing and understanding which of these erosion processes is occurring at a given location is crucial to designing the appropriate treatment or corrective measures. Once sediment is delivered to a stream, even the smallest of streams, it is seldom retrievable. Any sediment originating from county maintained roads, impacts water quality and aquatic habitat. Erosion prevention and control of sediment delivery must take place along the road, before eroded sediment gets delivered to a stream channel.

Of all the erosion processes in a watershed, road-related erosion is often the most easily identified and treated. Successful treatments for erosion prevention and erosion control along county roads should be designed to address the erosion process (surface erosion, fluvial erosion, or mass wasting). Not every source of sediment can be completely eliminated or prevented, but much of it can be. The choice should be among the most effective and cost-effective methods for reducing the risk of erosion or reducing the volume of eroded sediment that is delivered to streams.

Surface Erosion

Surface erosion results from raindrop impact and un-channeled water flowing over bare soil during and after rainstorms. Exposed soil is a common feature along roads, and



anywhere there is bare soil there will be surface erosion. This includes cutbanks, ditches, turnouts and unpaved sections of road. Although it is a chronic process, the more intense the rainfall and the greater the runoff, the more surface erosion occurs. Surface erosion turns into sediment delivery when the runoff discharges into a stream channel, often through rills or small gullies, or directly through road ditches.

Sediment Control Principles for Surface Erosion

- Keep bare soil to an absolute minimum when conducting land use activities. This is the single most effective method for preventing land use related surface erosion.
- Mulch or revegetate bare soil adjacent to stream channels, or other flow transport paths, to the break-in-slope near those areas. Mulching is the single most effective and cost-effective method for controlling surface erosion.
- Keep runoff from bare soil areas well dispersed. Dispersing runoff keeps sediment on-site and prevents sediment delivery to streams.
- Direct any concentrated runoff from bare soil areas into natural buffers of vegetation or to gentler sloping areas where sediment can settle out.
- Prevent rills by breaking large or long bare areas up into smaller patches that can be effectively drained before rills can develop.
- Disconnect and disperse flow paths, including roadside ditches, which might otherwise deliver fine sediment to stream channels. This prevents most sediment delivery.

Fluvial Erosion

Definition - Fluvial erosion includes gullying and stream bank erosion. Gullies, eroding channels greater than 1 ft² in cross section, form when concentrated runoff scours and erodes soil along its path. Along county roads, gullies are commonly found where road surface runoff has been collected and then discharged on adjacent hillslopes, where “shot-gun” culverts discharge onto erodible fill slopes, or where stream crossing culverts have plugged and overtopped.

Gullies are most commonly located below the outlets of ditch relief culverts, berm drains and below berm breaks; at shotgun culverts; on stream crossing fill slopes; and where runoff from upslope private properties flow over the road cut slope. The largest gullies often form when a stream-crossing culvert plugs and flow overtops the road. During large, infrequent storms and floods, stream crossings commonly fail in the following ways:

- Overtopping, which may occur when a culvert plugs, or its capacity is exceeded and water flows over the road and gullies the outside fillslope;
- Stream diversions occur when a culvert plugs or exceeds capacity and the stream flow goes down the road, instead of over-topping the stream crossing fill;



Rate of erosion - The amount of erosion that occurs is a combined function of the flow volume or flow velocity and soil erodibility. All else equal, the greater the flow the greater the gullying or bank erosion. Similarly, the more erodible the soil type the more soil loss will occur. Fine grained granular soils like silt and sand are most likely to erode; and rocky soils and bedrock are the least likely to erode.

Gullies usually form during large storm events, but they can also be a chronic source of sediment where gullies gradually increase in size or stream banks continue to erode during small and moderate runoff events. The large storm events usually trigger greatly increased fluvial erosion, as new gullies form and existing gullies enlarge.

Sediment delivery - Fluvial erosion is usually a very efficient sediment delivery mechanism. The larger a gully system, the more likely the eroded sediment will be delivered directly to a stream channel. Fluvial erosion rates can vary greatly between watersheds, depending on soil types, land use and land management practices. Finally, even gullies that have been stable for years can serve as efficient conduits for fine sediment delivered from other sources, such as road surfaces and ditches. Gullies are like conveyor belts; any sediment delivered to a gully system from another sediment source such as road surface runoff or cut bank erosion, is likely to deliver to a stream channel somewhere down slope.

Sediment Control Principles for Fluvial Erosion

- Prevent gullies by dispersing runoff from road surfaces, ditches and construction sites, by correctly designing, installing and maintaining drainage structures (e.g., road shape, rolling dips, culverts, etc.) and by keeping streams in their natural channels. No single point of discharge from a road or other disturbed area should carry sufficient flow to create gullies. If gullies continue to develop, additional drainage structures are needed to further disperse the runoff.
- Direct any concentrated runoff from bare soil areas, such as road surfaces, into natural buffers of vegetation, or to areas where sediment can settle out of the runoff.
- Dewater active gullies to prevent their enlargement and to reduce their capacity for sediment transport.
- Dewater old gullies, even if they are not actively eroding, so they no longer carry fine sediment to streams.
- When dewatering is not possible, options include channel armoring and grade control structures. However, these specialized erosion control techniques are more costly and less effective than prevention and dewatering gullies. Channel armoring and grade control structures typically require specific design, proper installation, and a commitment to maintenance.



Mass Wasting

Definition - On county roads, the two most common types of landslides are fill slope failures along the outer half of a road built on steep slopes, and cutbank failures where the natural hillslope has been undercut by road construction. Where roads are unstable, it is usually because of poor construction or maintenance practices (e.g., the use of uncompacted fills, fills containing organic debris or sidecast spoil disposal) or because of the location where they are built (e.g., steep slopes, unstable geologic materials or soils, or undercutting by stream bank erosion). Unstable roads are most commonly located on steep hillslope areas, and on soils or geologic materials that are regionally known to be unstable. Roads, especially wide roads, increase the frequency of landsliding by undercutting hill slopes, sidecasting poorly compacted fill onto steep slopes, and discharging road runoff onto potentially unstable slopes.

Rate of erosion – In many watersheds in California, mass wasting is a very important process of episodic (storm-triggered) sediment production and delivery to streams. Bigger storms are noted for increasing numbers of landslides, and this is especially true along roads. Some unstable fill slopes and cut banks fail all at once, while others show signs of instability for years before suddenly sliding. Signs of unstable road fillslope include cracks and scarps in the roadbed, and leaning trees on the fill slope. Signs of cutbank instability include leaning trees, scarps and the occurrence of failures, slumps and gullies that deposit material on the roadbed. These signs can be used to predict the location of road failures and to implement preventive treatments.

Sediment delivery - Landsliding creates sediment delivery when material slides into a stream channel. Some types of landslides are efficient at delivering sediment to streams while others rarely result in sediment delivery. Factors affecting direct sediment delivery from fill slope landslides include proximity to a stream, slope steepness, slope shape, moisture content, and soil composition. Road cutbank landslides are notoriously frequent where roads cross steep hillslopes, but typically lack major amounts of sediment delivery unless they are large enough to pass over the road and continue downslope. In contrast, road fill-slope failures are less frequent but result in direct sediment delivery when they are located close to a stream channel. Very few landslides deliver all their material to a stream. Some sediment is usually stored on the hillslope before reaching the stream.

Sediment Control Principles for Mass Wasting

- In general, the smaller the landslide, the more easily it can be prevented or controlled. In contrast, larger management-related landslides may be preventable, but they are very expensive to control once they begin sliding.
- Prevent accelerated landsliding by avoiding, minimizing or eliminating future sidecasting on steep or streamside hillslopes.
- Divert surface runoff and subsurface drainage to stable sites away from steep, unstable or potentially unstable slopes.
- Small fill slope landslides are often effectively prevented or controlled by direct excavation of all or most of the potentially unstable material. This is often the



- most effective and cost-effective technique for preventing road-related fill slope landsliding. If the roadbed is too narrow, move the road into the cutbank (cheapest) or rebuild the road with a structurally reinforced fill (most expensive).
- Control sediment delivery from some medium and large size fill slope landslides by excavating and removing material at the head of the slide. Removal of mass from the top of a slide may unload the slide sufficiently to stabilize the remaining mass. The amount of unloading required is a technical question that requires professional analysis, and the outcome of the unloading is not a certainty. A trained engineer or geologist should be consulted.
 - The most cost-effective sediment control treatment for large, uncontrollable landslides is often direct excavation and removal of slide material poised for delivery to a stream. This is the one-for-one rule where every cubic yard of material removed is a cubic yard not delivered to a stream by continued landsliding. This technique reduces sediment delivery but does not prevent or control landslide movement.
 - Sediment delivery from most cutbank landslides is not great, unless they are very large. Excavate landslide debris that is deposited on the road or in the ditch and haul it to a stable disposal site.
 - Large, old landslide scars are ugly but the main process is often surface erosion and gullyng of the surface. These processes are often difficult and costly to control due to the extremely steep slopes and harsh site growing conditions.
 - Revegetation is a valid long-term restoration technique for unstable and potentially unstable slopes, but revegetation is sometimes very difficult and the benefits will take decades to occur

“BIG THREE” COUNTY ROAD MAINTENANCE AND DESIGN PROBLEMS

Public roads, especially county roads, are unique and at an inherent disadvantage in meeting today’s water quality objectives. They were usually designed and constructed many decades ago, and many are located in riparian zones so close to streams that water quality impacts cannot be avoided. They were often built to follow early private road alignments, for convenience and to minimize construction costs. Water quality protection was not a consideration. Although elements of poor location cannot be easily addressed, as there is little or no realistic opportunity to alter their current alignment or location, design deficiencies can be solved through a program of gradual upgrading and long-term maintenance activities.

In spite of their inherent and inherited problems, many county roads have significant and correctable deficiencies in three of the most common sources of road-related water quality impacts. These are related to elements of 1) road surface drainage, 2) stream crossings, and 3) slope stability.



1) Road Surface Drainage Design

Standard drainage engineering practice calls for the collection, concentration and rapid discharge of road runoff into natural stream channels. This is the way roads have been historically designed. County roads often have long ditches that are hydrologically connected to nearby stream channels. That is, they carry surface runoff and fine sediment in ditches and these ditches discharge the flow into stream channels, either directly or through points of connectivity such as ditch relief culverts and gullies. This design facilitated the classic engineering approach to road surface drainage, but also kept costs to a minimum, in that few ditch relief culverts were required.

Four types of road features contribute to the continuing problem of “hydrologic connectivity” and its impacts on water quality. These include features or structures that collect and concentrate road surface runoff, and structures that then deliver the runoff and fine sediment to stream channels. These collecting and delivering road drainage structures are the very things that can be redesigned and modified to reduce water quality impacts from county roads while still satisfying requirements for public safety.

- ✓ Road surface shape (i.e. insloped, outsloped or crowned) determines whether all or a portion of the runoff, including sediment and chemical pollutants originating from the road right-of-way, are delivered to inboard ditches and stream channels or dispersed onto the adjacent hillslopes. Most county roads are paved, and this limits the amount of surface erosion that occurs throughout the road system. However, cutbanks, turnouts, ditches and many private drives are not surfaced, and they contribute storm runoff and eroded fine sediment to the road’s surface drainage system, and ultimately to local stream channels.
- ✓ Inboard ditches are designed to collect and deliver road run-off and road and cutbank derived sediment directly to ditch relief culverts or road-stream crossings. This has been classical engineering design of road surface drainage systems. Problems with inboard ditches are plentiful, and include erosion and down-cutting within the ditch, plugging of ditch relief culverts, alteration of natural hillslope drainage patterns, collection of emergent groundwater, and increased volume and velocity of runoff in both the ditches and adjacent stream channels. In more urbanized areas road drainage can deliver pollution from private driveways, as well as yard treatments such as fertilizers, insecticides and herbicides.
- ✓ Cross-road drainage structures such as ditch relief culverts often collect and discharge sufficient water to create gullies on hillslopes below the road. Likewise, water rapidly discharged from road ditches into natural drainage channels can increase a channel’s normal water load and force the channel to adjust by eroding its banks.



- ✓ Berms created along the outside edge of many county roads can retain and concentrate runoff over long road distances, similar to a ditch. Infrequent or inadequate berm breaches can cause the creation of hillslope gullies or deliver road-derived sediment and pollutants directly to stream channels.

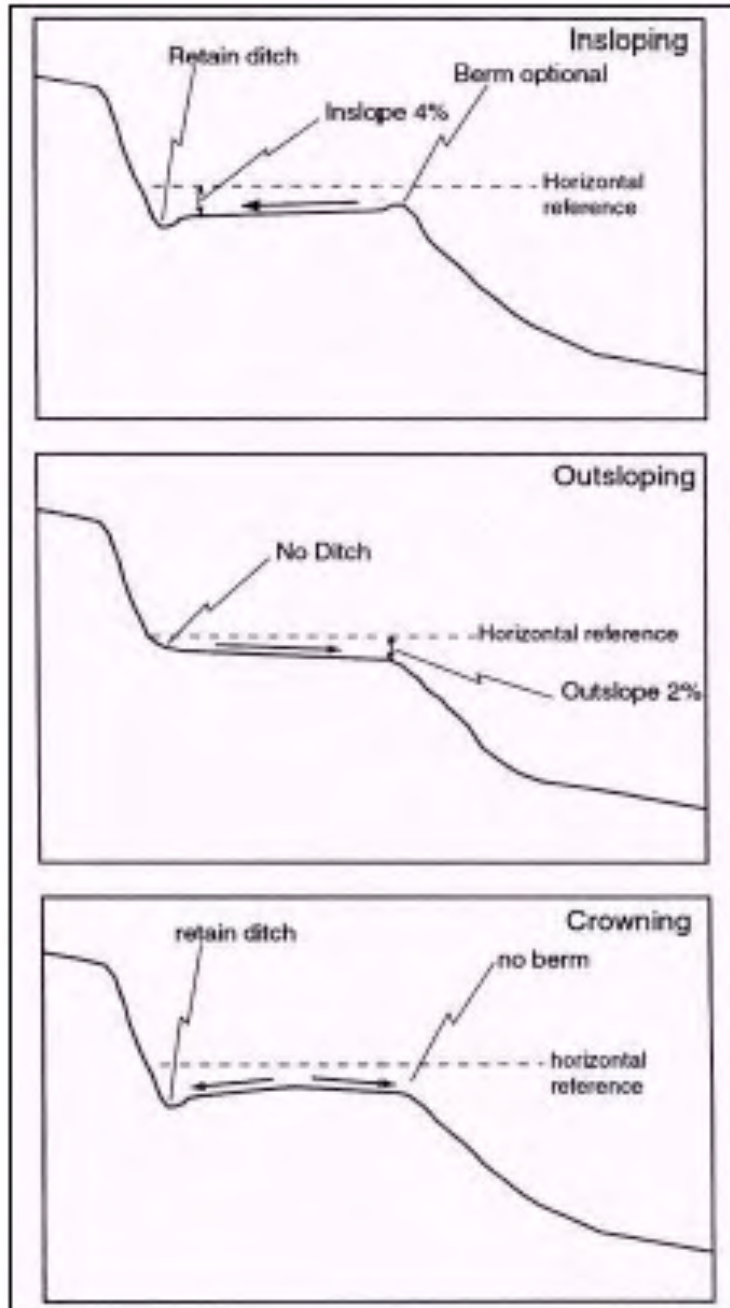

Figure 5.3 Utilizing road shape to reduce surface runoff. California Salmonid Stream Habitat Restoration Manual Chapter X. CDFG 2002.



2) Stream Crossing Design

Most existing stream crossings on county roads, especially culverted crossings, were built decades ago, and many exhibit serious deficiencies that impact or threaten water quality and aquatic resources, including listed salmon species.

- ✓ Culverts are the weak-points in most road systems, and many county roads have culverts that are significantly under-designed for today's standards. The most important culvert design deficiency is with *sizing*. Only a small percentage of culverts are sized to pass the 100-year design flow that is the current standard across California's wild lands. In addition, culverts that are undersized are more likely to fail by *plugging* with organic debris and sediment than by overtopping by flood flows. Most county road stream crossing culverts have not been designed to accommodate (or pass) organic debris and heavy sediment loads. Finally, culverts installed decades ago were often set high in the fill, not at the natural channel grade, and out-of-line with the natural channel. *Misalignment* encourages culvert plugging, increases maintenance requirements and can result in severe outlet erosion where shotgun culverts discharge onto unprotected fillslopes.
- ✓ Stream diversion potential is a design flaw in many culverted stream crossings on county roads, and elsewhere. When a culvert plugs, or its capacity is exceeded during a flood event, flood waters can only go two places: 1) across the road, over the fillslope and back into the natural stream channel, or 2) down the road and into another culvert or onto an adjacent hillslope. On average, the diverted stream is much more likely to cause severe off-site erosion, property damage and water quality impacts. Stream diversions can lead to inboard ditch erosion, additional stream crossing failures or diversions where diverted streamflow overwhelms culverts down the road, erosion and enlargement of natural stream channel dimensions, severe hillslope gully erosion, or it can trigger off-site road fillslope and hillslope landsliding.
- ✓ Fish passage is a critical stream crossing design consideration that must be considered today. Because of their location, county roads often parallel and cross streams that are, or once were, used by anadromous salmon and trout for spawning or rearing. Until recently, culvert and stream crossing designs did not consider fish passage requirements, let alone the needs for passage at all stages of the salmon's life cycle. By not considering this design element in their original construction or in subsequent culvert replacements, many stream crossings on county roads are currently barriers to fish passage.



Figure 5-1. Upgraded stream crossing to retain runoff in channel of origin and minimize sediment input to stream. (California Salmonid Stream Habitat Restoration Manual Chapter X. CDFG 2002).



Road-Related Landslides

Landslides are usually triggered by storms and floods. They episodically contribute sediment to stream channels via fill failures (directly) or indirectly through cutbank landslide cleanup and other spoil management or road maintenance practices.

Historically, landslide prevention work has been designed and undertaken to keep roads open, and not with the explicit goal of water quality protection. Similarly, until recently spoil management was a maintenance practice designed and conducted to keep roads clear, and not as a tool to protect and maintain water quality and fish habitat. Design standards and maintenance practices for county roads now need to actively consider water quality protection when identifying and treating potential fill failures and when planning and conducting spoils disposal from cutbank landslides.

- ✓ Fill slopes exhibiting tension cracks or scarps along the outer half of a county road, even when paved, frequently forecast future landslides that can deliver sediment to nearby streams below the road, especially on very steep slopes. Water focused improperly onto fill slopes by ditch relief culverts or berm breaches may further destabilize the road edge and cause erosion below the road shoulder. Some roads are so close to streams that the fill slope encroaches on the stream and fill failures are quickly delivered to the channel.
- ✓ Cutbank slope failures are unpredictable yet common along county roads. They deposit most of the slide material on the road prism and in the inboard ditch. As slope failures, cutbank slides usually deliver low volumes of material to streams, except for minor surface and gully erosion of the slide deposit washing fine sediment into inboard ditches and then into streams. The major concern with cutbank slides is spoil disposal: how and where is the slide material disposed.
- ✓ Spoil disposal from all landslide and related maintenance and clean-up activities is a severe concern with most county road systems, as county road management actions must be confined to the road right-of-way. Standards for spoil disposal have gone from free sidecasting prior to about 1985, regardless of location, to today's near total prohibition on sidecasting of spoil materials, even though such sidecasting may not threaten water quality.

PRINCIPLES FOR REDESIGNING AND TREATING COUNTY ROADS FOR WATER QUALITY PROTECTION

In this section we propose a three-pronged process, called "storm-proofing," for redesigning and treating County roads to lessen their impact on water quality, while still meeting transportation and safety objectives. This approach is complemented by a series of principles that can be used to identify, prescribe, prioritize and implement road-upgrading techniques. Storm-proofing consists of specific road upgrading and maintenance practices designed to lower the frequency and magnitude of stream crossing and road fill slope failures, and to reduce both episodic and chronic sediment delivery.



County roads are sometimes poorly located in relation to water quality. Designing for better locations is generally not a practical solution to road-related water quality problems, because property lines and rights-of-way are legally fixed. With few exceptions, such as road alignments through public lands, County roads will remain where they are currently located. For this reason, the main tools that are available to protect water quality include specific practices designed to make roads more resilient to infrequent, large storms and erosion, and to reduce their chronic discharge of fine sediment and turbid runoff.

Storm-Proofing County Roads

The vast majority of County roads were constructed many decades ago with very different design and construction standards than are in effect today. Historic designs included long ditches discharging storm runoff and fine sediment directly to streams; stream crossings with short, undersized culverts, diversion potentials and high plugging potential; stream crossings that are barriers to fish migration; fillslopes that are susceptible to slope failure; and uncontrolled spoil disposal practices. Those days are gone, and they have been replaced with standards that meet transportation needs while protecting water quality.

The fundamental design components of a storm-proofed county road are simple in concept, and there are a number of alternative methods or practices that can be used to achieve these objectives:

Storm-proofing road surface drainage

- Roads are hydrologically “disconnected” from the natural stream channel network; this includes disconnecting current discharge sites by installing additional drainage structures or features such as ditch relief culverts, road shaping, berm removal, and rolling dips.
- Typically no more than 150 feet of road or ditch should drain directly to any stream crossing.
- Road surface and ditch drainage structures are installed frequently enough such that gullies do not form below the road and those with gullies are dewatered.

Storm-proofing stream crossings

- Drainage structures (culverts, fords, bridges, etc) are designed to accommodate the 100-year peak flow, including floating debris and sediment.
- Culverts are designed to have a low plugging potential.
- Stream crossings do not have a diversion potential.
- Culverts are bedded at or near the natural channel grade, and in alignment with the natural channel.
- Shotgun culvert outlets are fitted with downspouts or energy dissipation.
- Culvert inlets, outlet and bottom are in open and sound condition.
- Crossings of Class 1 streams accommodate adult and juvenile fish passage.



- Bridges do not significantly restrict channel capacity for the 100-year flood flow.

Storm-proofing unstable fill slopes

- Slope failures that threaten sediment delivery are treated to prevent landsliding or minimize sediment delivery when a failure does occur.
- Small, unstable fillslopes that would deliver are excavated or structurally stabilized so they do not fail during storms.
- Larger unstable fillslopes with potential to deliver are stabilized by buttressing, retaining, partial excavation, reconstruction, or by other means.
- Excavated spoil is stored in a location that is stable and will not deliver eroded sediment to a stream.

A STRATEGY FOR IMPLEMENTING CHANGE

A three-step process can be used for prescribing and conducting storm-proofing on County roads. The steps include:

- Identifying problems and prescribing treatments
- Prioritizing proposed erosion prevention activities (to take advantage of limited funds)
- Implementing upgrading work

A forward-looking sediment inventory, one that identifies treatable sites of future erosion and sediment delivery, is first conducted along a County road system. This inventory utilizes field assessments that are based on logical, standardized, science-based observations, measurements, and deductive reasoning (CDFG, 2004). The goal of this uniform data collection and resultant inventory is to deliver a storm-proofing and road upgrading plan that:

- Identifies the nature and magnitude of the erosion and sediment delivery problems;
- Provides quantified risk assessment data;
- Estimates the volume of sediment that could be prevented from delivery to streams;
- Develops a prioritized list of treatment prescriptions and associated cost estimates.

Data analysis is performed when all the inventory information has been collected, properly entered in the database and cleaned. The use of a database allows for rapid data analysis, cost analysis, and prioritization. Data tables developed for the restoration plan contain summary information regarding the number of sites recommended for treatment, erosion potential, treatment immediacy (priority), potential sediment savings, recommended treatments, excavation volumes, estimated heavy equipment and labor hours and costs.



After prescribing treatments and evaluating costs (for access and treatment), employ cost-effectiveness calculations and other criteria to prioritize all the inventoried sites for actual treatment. The cost-effectiveness of treating a restoration work site is defined as the average amount of money spent to prevent one cubic yard of sediment from entering or being delivered to the stream system (Weaver and Sonnevil, 1984). Cost-effectiveness is determined by dividing the cost (\$) of accessing and treating a site, or group of sites, by the volume of sediment prevented from being delivered to local stream channels. Use cost-effectiveness as a tool to prioritize potential treatment sites throughout a watershed or along a road network. The key elements in determining cost-effectiveness are a fair and accurate estimate of future sediment delivery (in the absence of treatment) and a reasonable estimate of treatment costs.

Once they are prescribed and prioritized, and funding has been secured, storm-proofing projects are implemented. For water quality and fisheries protection, the goal of upgrading County roads is to minimize the contributions of fine sediment from roads and ditches to stream channels, as well as to minimize the risk of episodic erosion and sediment delivery when storms and floods occur. The most important of these include upgrading stream crossings for the 100-year storm event, prevention of culvert plugging and failure, elimination of stream diversion potential, removal of unstable sidecast and fill materials from steep slopes, and the application of drainage techniques to improve dispersion of road surface runoff. The assessment plan will define which are the most critical and most cost-effective projects to undertake first.

Principles of Storm-Proofing Implementation

Below are six fundamental road assessment and treatment principles, which if observed, will go far in protecting water quality and stream habitat. Although ensuring that roads are open and safe to the traveling public remains each county's number one priority, water quality and habitat goals are concurrently achievable.

These principles are straightforward and sometime obvious, but many are not systematically or routinely applied. Most principles are simple procedures or ways of thinking about and seeing road-related problems in a new light, and formulating long-term solutions. Developing these thoughts and supporting these principles through in-house training, education, field trips, and implementation practices will encourage managers and field maintenance staff to think about ways they can achieve both goals. Conducting road storm-proofing requires both recognition of problems and solutions, as well as a long term commitment to gradually chip away at prioritized projects, and to seek needed funding, in a process that will likely be measured in decades, not years. Getting everyone "on the same page," thinking in the same way, is the first step in this process.



Principle #1. Treat causes, not symptoms – Learn to recognize the true cause of erosion and attack the cause, not the symptom, of erosion and sediment delivery.

The only way to solve a problem is to treat its cause. If the cause of culvert failures, stream diversions, fillslope failures and road connectivity are not addressed, water quality degradation and road failures will continue to occur.

For example, repeatedly cleaning undersized culverts of accumulated sediment and debris is treating the symptom of the problem. The cause of the problem is that the culvert is not properly designed to effectively handle woody debris or heavy sediment loads, and treating the cause would entail the installation of a larger culvert or a debris barrier. Another example would be the treatment of gullying below a ditch relief culvert or berm drain outlet. Armoring the slope or gully to prevent continued erosion on the hillslope would be a symptomatic treatment, whereas reducing the volume of flow to the culvert or berm drain, by installing additional drainage structures along the road, would address the cause of the problem.

In order to begin the process of truly correcting causes and lowering the risk of future erosion and sediment delivery, many counties in coastal California have undertaken comprehensive inventories and assessments along county roads. These include the counties of Trinity, Del Norte, Humboldt, Mendocino, Sonoma, Marin, San Mateo, Santa Cruz and Monterey. The assessments have focused on both chronic and episodic sediment sources utilizing Fish and Game approved road assessment, erosion control, and storm-proofing protocols (CDFG, 2004, Chapter 10) as well as culvert inventories to evaluate and correct fish passage (CDFG, 2003, Chapter 9).

These approved approaches provide county managers and engineers with a prioritized “action plan” which defines which stream crossing sites or road reaches pose a higher risk of ongoing or future sediment delivery to streams and impacts to water quality. Likewise, the methods provide a systematic method for identifying and correcting County stream crossings that restrict or prevent fish passage. These procedures allow county staff to evaluate the extent and magnitude of the sediment production risk or fish passage problems, and serves as a long term planning tool for identifying and prioritizing road storm-proofing and upgrading activities, and correcting fish passage problems.

Principle #2. Fix problems, don’t apply band aides - Changing things that don’t work is the only way to improve road performance and protect water quality - if you don’t change things, reoccurring problems will reoccur.

The only sure way to improve the response or behavior of a road and prevent water quality problems is to change site conditions so that they are less susceptible to failure. For example, cleaning plugged culverts during a winter storm does not solve the problem of a high plugging potential. In contrast, culvert plugging potential can be permanently reduced by the installation of a larger culvert sized to pass the 100-year flood flow, a debris trash rack upstream from the culvert inlet or a flared inlet.



Principle #3. Be forward-looking and use prevention strategies - It's generally more effective and less expensive to prevent erosion than to control, repair or potentially pay fines for road damage and sedimentation.

Once erosion gets started, it can be very costly, or sometimes impossible, to control. A “properly designed and upgraded” road or construction site saves money in the long run, needing less short and long term maintenance while avoiding catastrophic failures and expensive repairs. Once sediment is introduced to a stream channel, it can rarely be efficiently removed from the channel. Both state and federal agencies with responsibility to enforce the Clean Water Act and the Endangered Species Act are increasingly looking at county road practices and activities that impact water quality. Water quality violation can result in large fines that should be viewed as part of the cost of not preventing erosion. Consequently, every effort should be made to recognize where sediment is being delivered to any stream, and develop a treatment prescription that either prevents future sediment delivery or minimizes the volume of sediment delivery.

Principle #4 – Expect and anticipate floods – Apply practices and install structures that have been designed to withstand 100-year flood events.

Large magnitude winter storms create the most havoc with road systems. Don't design your roads to “get by” during the average winter, and don't guess at what needs to be done to storm-proof your road. Don't replace what's already there by the same thing or by what you might have available in the culvert yard simply because you have the correct size. Similarly, if a stream-crossing culvert is undersized and is to be replaced, don't guess what size culvert should be installed. Conduct road assessments in advance and then consult and use these assessments in the normal course of road upgrading and maintenance work. It is important that road supervisors know how to use and apply these plans. Such foresight and planning will minimize future stream crossing failures, prevent stream diversions and reduce the number and size of road fill failures.

Principle #5. Disconnect and disperse runoff - Disperse road and ditch runoff frequently to prevent gulying and to disconnect road surface runoff and ditch flow from natural stream channels.

Chronic erosion and sediment delivery from roads impacts stream channels every year. In order to disperse (not collect) roadbed runoff on unsurfaced roads, converting insloped and flat roadbed shapes on unpaved roads to outsloped or crowned road beds, or frequently “roll” the road shape to provide for regular drainage. Likewise, install frequent drainage structures (rolling dips, ditch relief culverts, berm breaks) along roadbeds and inboard ditches to disperse road runoff.

Principle #6 – Think and act “holistically” and long-term - Envision how your project will function in the first storm, and in the “big” storm; recognize ways you can anticipate and avoid potential negative impacts or future problems while



increasing resource protection resulting from road upgrading and road maintenance practices.

- Predicting performance - Envision project performance and how your project will function in the first storm, and in the “big” storm. Don’t just do things because you’ve always done it that way. Always consider the unintentional effects and impact of your work. Envision your project or maintenance work as it responds to heavy winter rainfall and runoff events; where will runoff go and how much will occur? See your work through the “eyes” of a raindrop and a rivulet of runoff during the first winter storm, and through the “eyes” of the fish in the stream that may receive that runoff.
- Riparian protection - The riparian zone is the land and vegetation adjacent to lakes, watercourse, estuaries, and wetland areas. Protecting and restoring healthy riparian zones is the best defense for maintaining a healthy stream. The plants in the riparian zone create cool water temperature, supply large wood needed for fish habitat, and filtrate sediment and pollution before it reaches the stream. They also provide stream bank and hillslope stability, help with channel stability and promote high quality fish and wildlife habitat.
- Vegetation and revegetation - Protect and retain existing vegetative cover. Plant cover provides your cheapest form of effective and long-term erosion control. Native grasses, shrubs and trees help stabilize cut and fill slopes. Make sure a revegetation plan is included as a final element of all road-upgrading projects, especially those involving vegetation removal. A vegetation management plan should address the removal of invasive non-natives.
- Fish passage - When replacing or upgrading stream crossings on salmon and steelhead bearing streams your project needs to provide for fish passage. No stream crossings should block the upstream or downstream migration of salmon and steelhead at all life stages. Monitor structures for performance during the winter season. Consult with a qualified fisheries biologist or engineer who is trained in evaluating and implementing fish passage projects.
- Maintenance monitoring - Monitor conditions, record and report your observations to appropriate division supervisors. Prioritize your response to problems to prevent more serious failures and sediment problems. Develop a “maintenance-monitoring” system for recording problems and tracking maintenance performed at sites; and keep these records in an electronic database. Over the years, as personnel come and go, this record will become your invaluable institutional memory of the County road system. Storm inspections, repairs, and maintenance monitoring are critically important tools to prevent serious damage and resource.



- The county road system was developed over the past 150 years based on public transportation needs. Some road sections are poorly located from both transportation and water quality perspectives. Often, county transportation planners or road engineers may not be aware of recurring problems on a road. It is crucial that maintenance departments promptly alert engineering or planning departments about significant problems and their impact on watercourses, so that alternatives may be considered. Maintenance monitoring is a tool to help accomplish this. Balancing the public's need for safe and open roads with the environment's need for clean water and healthy streams is challenging but not impossible. Remember: the public also needs clean water and healthy streams.

For further reference on protecting aquatic habitat while conducting road and culvert related restoration projects, see the Department of Fish and Game Salmonid Stream Habitat Restoration Manual, Chapters IX and X. Flosi et al, 2002.



|

|



5.2 PAVED ROAD SURFACES

DESCRIPTION

Paved road maintenance provides a safe roadway surface for the traveling public and prevents further roadway deterioration or failure. Repair activities include: pothole and square cut patching; replacing base and surfacing; repaving; extending pavement edge; paving graveled shoulder; crack sealing; overlay; chip seal; slurry seal; pavement marking; traffic channelization; addition of traffic control features and removal of excess material for disposal or recycling.

ENVIRONMENTAL CONCERNS

The major risks during paved road surface maintenance are:

- ✓ Discharge of the following materials into a stream channel, stormwater drainage system or riparian area:
 - Sediment, asphalt concrete binder, liquid asphalt, asphalt concrete (AC), asphalt emulsion, sealant material, Portland cement concrete (PCC), concrete rinse water, concrete grindings and cuttings, concrete waste and diesel oil
- ✓ Harm to riparian vegetation.

BMP OBJECTIVES

- ✓ Minimize road-related materials entering storm drain inlets and watercourses.
- ✓ Reduce sediment entering storm drain inlets and watercourses.
- ✓ Encourage recycling.

BEST MANAGEMENT PRACTICES

GENERAL

- 1) Inspect all road and drainage facilities after a 25-year storm event. Report to road managers locations of road surfaces, drainage features, cutslopes and fillslopes that appear to be failing and contributing sediment to streams in order to prioritize maintenance or repair. Standardize and document reports
- 2) Regularly inspect equipment for leaks, damage and oil or grease buildup before starting work, and regularly in the field. Use non-organophosphate hydraulic fluid. Place drip pans under any equipment needing emergency service or repair in the field. Except in emergencies, always take equipment and vehicles to a repair facility for maintenance.
- 3) Set up work area to minimize environmental impacts:
 - Identify riparian areas (areas adjacent to watercourses) and keep equipment out of them.



- Designate areas for parking, fueling and minor equipment maintenance (during and after shifts) where pollutants will not be discharged to watercourses or storm drains.
 - Park paving equipment over drip pans or absorbent materials.
- 4) Identify storm drain inlets, manholes, and watercourses before beginning work. If there is any risk of discharge of sediment or road-related material, protect storm drains with appropriate Erosion Control and Sediment Management BMPs. Make sure any wash water is contained locally, and that none is discharged into the storm drain or watercourses.
 - 5) Make sure personnel are trained to respond appropriately to spills. Carry a spill kit for immediate cleanup of any spills related to equipment failure (see *Appendix A-Planning and Prevention BMPs: Small Spill Kit*). Do not hose down the work area or pour any materials down drains.
 - 6) Dispose of all excess materials from paved road maintenance activities at designated sites consistent with spoil disposal and stockpile requirements for various materials (see *Chapter 7.3 Spoils Handling and Disposal*). Recycle excess materials.

SEASONAL CONCERNS

- 1) Perform routine maintenance during the dry season. Avoid working in wet conditions or during the wet season (October 15-April 15), except for emergencies such as pothole patching, since rain and flooding greatly increase the risk of pollutant runoff.

SPOILS AND SIDECASTING (See *Chapter 7.3- Spoils Handling and Disposal*.)

- 2) Avoid sidecasting of soil in all cases where it could be delivered into a watercourse, riparian area, roadside ditch or storm drain. Do not sidecast outside of the County right-of-way, without landowner's permission. In some instances, under the following guidelines (See Table below), sidecasting is allowable given remote distances from spoils storage sites. In these cases, the setback distance required depends on slope and vegetation. The presence of vegetation helps to slow the travel of sediment downslope, so good judgment is needed to assess the situation. *Do not sidecast at all* if the slope is sparsely vegetated and it appears that sediment will travel with rain runoff into a stream or estuary system, even if setback distances are applied. On slopes of 5:1 (20% gradient) or less, sidecasting is allowed beyond 150 feet of a watercourse, stream crossing, riparian area, roadside ditch or storm drain. On 2:1 slopes (50%) or less, sidecasting is allowed beyond 300 feet of a watercourse, stream crossing, riparian area, roadside ditch or storm drain. On slopes greater than 2:1, typically sidecasting is *not allowed at all*, however there may be rare instances on slopes greater than 2:1 where sidecasting is acceptable given very long distances from waterbodies and good vegetative cover. Seek advice from local fisheries agency staff when in doubt. Avoid concentrating sidecasting repeatedly in the same place. Never sidecast large amounts of soil from major landslides.



SLOPE GRADIENT	DISTANCE FROM WATERCOURSE, STREAM CROSSING, RIPARIAN AREA, ROADSIDE DITCH, STORM DRAIN	SIDECASTING RULE
Any slope	Appears that sediment will travel with rainwater into watercourse.	Not allowed
5:1 (20%) or less	150 feet or more	Allowed using good judgment
2:1 (50%) or less	300 feet or more	Allowed using good judgment
Greater than 5:1 (50%)	Vegetated slope long distance from watercourse	Allowed
Greater than 5:1 (50%)	Sparsely vegetated slope and it appears that sediment will travel with rain into watercourse	Not allowed

- 3) Temporary spoils stockpiles should be located in areas that are relatively level; relatively free of vegetation and away from streams and wetlands areas. The primary concern is to keep stockpiled materials from eroding into stream or wetland systems. Apply erosion control BMPs when needed. Do not place temporary spoils piles at the top of unstable slopes or at the edges of slopes where water will carry sediment into watercourses. Remove temporary stockpiles to permanent disposal locations before the rainy season. If emergency work is conducted during the rainy season, remove stockpile as soon as feasible and before the next rain storm.

BERMS (See 5.5- *Shoulder Maintenance*.)

- 4) Do not leave loose soil piled in berms alongside the road or ditch. Loose or exposed soil berms are erodible and readily flushed into waterways and storm drains.
- 5) If any berm is left in place for public safety it must be compacted and stabilized with seeding or asphalt. Frequent well placed breaks in the berms are necessary to allow water to drain from road, preserving the natural drainage pattern of the slope.

ROAD DRAINAGE (See 5.1-*Road Treatment and Design Principles* and 5.6- *Drainage Systems* for specifications.)

- 6) Note areas of natural cross drainage. Document in writing any significant changes to drainage patterns resulting from road surface maintenance and report to County Engineering or Planning.



- 7) On problem roads, look for opportunities to reconstruct the road to improve and maintain natural drainage patterns; for example, add rolling dips, critical dips and/or additional cross drains. (See 5.1-Road Treatment and Design Principles).

BMP TOOLBOX

Planning and Prevention BMPs

- ✓ Seasonal Planning
- ✓ Small Spill Kit

Road Drainage

- ✓ Ditch Relief Culvert
- ✓ Rolling Dip
- ✓ Outsloping
- ✓ Critical Dip

Erosion Control BMPs

- ✓ Blankets/Geotextile Fabrics
- ✓ Mulching
- ✓ Planting
- ✓ Plastic Covering
- ✓ Seeding

Sediment Control BMPs

- ✓ Coir Log/Straw Roll
- ✓ Storm Drain Inlet Protection
- ✓ Silt Mat/Vegetated Grassy Swale
- ✓ Sand Bag
- ✓ Silt Fence
- ✓ Siltation Pond/Settling Pond

* Note: Some of these are temporary measures that need to be removed upon completion of work and replaced with more permanent structures. See Appendix A for details on removal.

PERMITS

5.2 PAVED ROAD SURFACES	
Activity or Condition	Required permit or limitation
Replacement of road base or surfacing next to sensitive habitats	Consult with CDFG or NOAA Fisheries as appropriate.



5.3 UNPAVED ROAD SURFACES

DESCRIPTION

Good maintenance practices on unpaved road surfaces prevents roadway erosion, deterioration or failure; helps with sediment and dust control, and provides a safe roadway surface for the traveling public. Unpaved road maintenance includes grading, repairing, or maintaining unpaved road surfaces. See 5.4 -*Shoulder Maintenance* for best road design and drainage engineering techniques to use to prevent erosion and protect salmon and aquatic habitat.

ENVIRONMENTAL CONCERNS

- ✓ Discharge of sediment or dust abatement chemicals into a stream or a stormwater drainage system.
- ✓ Harm to fish and aquatic life as a result of pumping water from streams for dust abatement.
- ✓ Concentrated runoff leading to erosion.

BMP OBJECTIVES

- ✓ Preserve or improve surface drainage in the vicinity of the road.
- ✓ Disconnect road drainage features from watershed hydrology.
- ✓ Make sure drainage is self-maintaining.
- ✓ Minimize amount of road-related sediment that gets into watercourses.
- ✓ Prevent dust abatement chemicals from getting into watercourses or riparian areas.

BEST MANAGEMENT PRACTICES

SEASONAL CONCERNS

- 1) Perform routine road surface maintenance during the dry season. Avoid working in wet conditions and during the wet season (October 15- April 15), except for emergencies. Disturbed soil combined with rainfall, greatly increase the risk of exposed sediment runoff into streams.
- 2) Inspect roads and associated drainage facilities for signs of erosion or deterioration at least twice annually with at least one inspection during or after first storm events of the season with additional follow-up for severe storm events. Inspect all road and drainage facilities after a 25-year storm event. Report locations of road surfaces, drainage features, cutslopes and fillslopes that appear to be failing and contributing sediment to streams in order to prioritize maintenance or repair. Standardize and document reports.



SURFACE GRADING

- 3) In general, maintain unpaved roads to obtain a less erosive running surface and to minimize the need for frequent surface grading. Blade and compact a smooth surface and compact loose soils as needed.
- 4) Crown or slope the road to avoid ponding or concentration of runoff. Outslope all roads where possible and safe, consulting with County Engineering on specifications. (See 5.1 - *Road Treatment and Design Principles*.)
- 5) Repair rutting/failing areas, if needed.

SPOILS AND SIDECASTING (See Chapter 7.3- Spoils Handling and Disposal.)

- 6) Avoid sidecasting of soil in all cases where it could be delivered into a watercourse, riparian area, roadside ditch or storm drain. Do not sidecast outside of the County right-of-way, without landowner's permission. In some instances, under the following guidelines (See Table below), sidecasting is allowable given remote distances from spoils storage sites. In these cases, the setback distance required depends on slope and vegetation. The presence of vegetation helps to slow the travel of sediment downslope, so good judgment is needed to assess the situation. *Do not sidecast at all* if the slope is sparsely vegetated and it appears that sediment will travel with rain runoff into a stream or estuary system, even if setback distances are applied. On slopes of 5:1 (20% gradient) or less, sidecasting is allowed beyond 150 feet of a watercourse, stream crossing, riparian area, roadside ditch or storm drain. On 2:1 slopes (50%) or less, sidecasting is allowed beyond 300 feet of a watercourse, stream crossing, riparian area, roadside ditch or storm drain. On slopes greater than 2:1, typically sidecasting is *not allowed at all*, however there may be rare instances on slopes greater than 2:1 where sidecasting is acceptable given very long distances from waterbodies and good vegetative cover. Seek advice from local fisheries agency staff when in doubt. Avoid concentrating sidecasting repeatedly in the same place. Never sidecast large amounts of soil from major landslides.
- 7) Temporary spoils stockpiles should be located in areas that are relatively level; relatively free of vegetation and away from streams and wetlands areas. The primary concern is to keep stockpiled materials from eroding into stream or wetland systems. Apply erosion control BMPs when needed. Do not place temporary spoils piles at the top of unstable slopes or at the edges of slopes where water will carry sediment into watercourses. Remove temporary stockpiles to permanent disposal locations before the rainy season. If emergency work is conducted during the rainy season, remove stockpile as soon as feasible and before the next rain storm.



SLOPE GRADIENT	DISTANCE FROM WATERCOURSE, STREAM CROSSING, RIPARIAN AREA, ROADSIDE DITCH, STORM DRAIN	SIDECASTING RULE
Any slope	Appears that sediment will travel with rainwater into watercourse.	Not allowed
5:1 (20%) or less	150 feet or more	Allowed using good judgment
2:1 (50%) or less	300 feet or more	Allowed using good judgment
Greater than 5:1 (50%)	Vegetated slope long distance from watercourse	Allowed
Greater than 5:1 (50%)	Sparsely vegetated slope and it appears that sediment will travel with rain into watercourse	Not allowed

BERMS (See 5.5- *Shoulder Maintenance*.)

- 8) Do not leave loose soil piled in berms alongside the road or ditch. Loose or exposed soil berms are erodible and readily flushed into waterways and storm drains.
- 9) If any berm is left in place for public safety reasons (see Chapter 5-5, BMP 5) it must be compacted and stabilized with seeding or asphalt. Frequent well placed breaks in the berms are necessary to allow water to drain from road, preserving the natural drainage pattern of the slope.

ROAD DRAINAGE (See 5.1-*Road Treatment and Design Principles* and 5.6- *Drainage Systems* for specifications.)

- 10) Note areas of natural cross drainage. Document in writing any significant changes to drainage patterns resulting from road surface maintenance and report to County Engineering or Planning for approval.
- 11) On problem roads, look for opportunities to reconstruct the road to improve and maintain natural drainage patterns; for example, add rolling dips, emergency water bars and additional cross drains. (See 5.2-*Road Treatment and Design Principles*).



DUST CONTROL (See *Appendix C- Dust Palliative Application Guidelines.*)

- 12) Do not apply chemical dust palliatives during rain or immediately before anticipated rain. Approved dust control agents are preferred over water drafting and application.
- 13) Follow manufacturer's recommendations when applying chemical dust palliatives. Do not apply chemical or petroleum-based palliatives where they may enter a stream or watercourse unless specifically approved for such use
- 14) Dispose of excess dust abatement materials at designated sites (see *Chapter 9.4 – Maintenance Facilities- Waste Handling, Storage, and Disposal*).
- 15) Make sure personnel are trained to respond appropriately to spills during use of chemical dust palliatives. Carry a spill kit for prompt cleanup (see *Appendix A - Planning and Prevention BMPs: Small Spill Kit*), using appropriate procedures. Do not hose down the work area or pour any materials down drains.

WATER DRAFTING (See *Appendix C-Technical References, Water Drafting Guidelines.*)

- 16) Notify Department of Fish and Game, before drafting water from streams or other waterbodies for dust control or moisture conditioning,. DFG permits drafting if certain basic protectionary conditions are in place. If a work site is to be temporarily dewatered by pumping, intakes should be completely screened with wire mesh not larger than 5 millimeters to prevent amphibians from entering the pump system.
- 17) Appendix C contains both *NOAA Fisheries Water Drafting Specifications* and *DFG Guidelines for Temporary Water Drafting*. The requirements and specifications are detailed and can be found in both of these documents- a helpful resource when preparing permit applications and working with agency staff.
- 18) Check appropriate water rights for stream that is used for drafting, set by the Division of Water Rights: <http://www.waterrights.ca.gov/>

BMP TOOLBOX

Planning and Prevention BMPs

- ✓ Seasonal Planning
- ✓ Small Spill Kit

Road Drainage

- ✓ Ditch Relief Culvert
- ✓ Rolling Dip
- ✓ Outsloping
- ✓ Critical Dip

Erosion Control BMPs

- ✓ Blankets/Geotextile Fabrics
- ✓ Mulching



- ✓ Planting
- ✓ Plastic Covering
- ✓ Seeding

Sediment Control BMPs

- ✓ Coir Log/Straw Roll
- ✓ Storm Drain Inlet Protection
- ✓ Silt Mat/Vegetated Grassy Swale
- ✓ Sand Bag
- ✓ Silt Fence
- ✓ Siltation Pond/Settling Pond

* Note: Some of these are temporary measures that need to be removed upon completion of work and replaced with more permanent structures. See Appendix A for details on removal.

PERMITS

5.3 UNPAVED ROAD SURFACES	
Activity or Condition	Required permit or limitation
In a Coastal Zone, conducting unpaved road maintenance activities below the high tide line.	Coastal Zone Development Permit or Coastal Development Exception from County Planning or the California Coastal Commission
Diverting or obstructing flow from streams or watercourses (including water drafting for dust control or moisture conditioning)	Fish and Game Code Section 1600 requires: <ul style="list-style-type: none"> • formal notification to DFG • 1602 Standard Streambed Alteration Agreement (with DFG’s recommended protectionary steps) if DFG determines it is needed. http://www.dfg.ca.gov/1600/qa1.html
Any activities covered by local regulations	Local permits
Use of serpentine rock and asbestos-containing aggregate for unpaved surfacing.	This use is prohibited by California Air Resources Board air quality rules. To ensure the aggregate is asbestos-free, outside contractors that resize and/or crush rock must have MSHA (Mining Safety and Health Administration) 46 Identification number.





5.4 SHOULDER MAINTENANCE

DESCRIPTION

Areas adjacent to surfaced and unsurfaced roads require maintenance to provide a usable area for vehicles to pull off the traveled way, prevent the loss of lateral road support, the deterioration or failure of the edge of road surfaces, and to maintain roadside drainage patterns. Shoulder maintenance activities include shoulder blading and rebuilding, and smoothing ruts.

ENVIRONMENTAL CONCERNS

- ✓ Delivery of sediment from grading activities or improper disposal of spoils into streams or storm water drains.
- ✓ Damage to vegetation that provides erosion control on slopes.
- ✓ Harm to riparian areas and rare plant populations.

BMP OBJECTIVES

- ✓ Reduce amount of sediment and debris entering streams or storm drains.

BEST MANAGEMENT PRACTICES

- 1) Perform routine maintenance during the dry season, between April 15th and Oct 15th. If emergency work must be performed during the rainy season, perform work during dry weather.
- 2) Avoid disturbance of vegetation outside the essential shoulder area, especially near ditches, streams or watercourses. These vegetated areas help filter sediment from water run-off into ditches or streams and helps prevent erosion.
- 3) Avoid sidecasting of soil in all cases where it could be delivered into a watercourse, riparian area, roadside ditch or storm drain. Do not sidecast outside of the County right-of-way, without landowner's permission. In some instances, under the following guidelines (See Table below), sidecasting is allowable given remote distances from spoils storage sites. In these cases, the setback distance required depends on slope and vegetation. The presence of vegetation helps to slow the travel of sediment downslope, so good judgment is needed to assess the situation. *Do not sidecast at all* if the slope is sparsely vegetated and it appears that sediment will travel with rain runoff into a stream or estuary system, even if setback distances are applied. On slopes of 5:1 (20% gradient) or less, sidecasting is allowed beyond 150 feet of a watercourse, stream crossing, riparian area, roadside ditch or storm drain. On 2:1 slopes (50%) or less, sidecasting is allowed beyond 300 feet of a watercourse, stream crossing, riparian area, roadside ditch or storm drain. On slopes greater than 2:1, typically sidecasting is *not*



allowed at all, however there may be rare instances on slopes greater than 2:1 where sidecasting is acceptable given very long distances from waterbodies and good vegetative cover. Seek advice from local fisheries agency staff when in doubt. Avoid concentrating sidecasting repeatedly in the same place. Never sidecast large amounts of soil from major landslides.

SLOPE GRADIENT	DISTANCE FROM WATERCOURSE, STREAM CROSSING, RIPARIAN AREA, ROADSIDE DITCH, STORM DRAIN	SIDECASTING RULE
Any slope	Appears that sediment will travel with rainwater into watercourse.	Not allowed
5:1 (20%) or less	150 feet or more	Allowed using good judgment
2:1 (50%) or less	300 feet or more	Allowed using good judgment
Greater than 5:1 (50%)	Vegetated slope long distance from watercourse	Allowed
Greater than 5:1 (50%)	Sparsely vegetated slope and it appears that sediment will travel with rain into watercourse	Not allowed

- 4) Except as provided in #5 below, do not leave loose soil piled in berms alongside the road or ditch. Loose or exposed soil berms are erodible and readily flushed into waterways and storm drains. Remove excess berm material before the rainy season. If placed in emergency during the rainy season, remove as soon as possible before the next rain. Dispose of all excess materials from shoulder maintenance activities in appropriate spoil disposal sites. (see *Chapter 7.3-: Spoils Handling and Disposal*).
- 5) Berms are used in some places for traffic delineation or public safety (i.e. line of sight along soft shoulders with steep drop-offs). If any berm is left in place it must be kept to a minimum height and be compacted and stabilized with native seeding or asphalt. Use Erosion Control BMPs to stabilize berms that are being left in place for road delineation.
- 6) Frequent well placed breaks in the berms are necessary to allow water to drain from road and back into its original channel, preserving the natural drainage pattern of the slope. Check the areas breached to make sure they are stable. If erosion occurs at berm breaching areas, or the seeding is not in yet and rains are approaching, apply Erosion Control BMPs directly.
- 7) Stabilize disturbed or bare soils along cutslopes and fillslopes with Erosion Control BMPs. If not otherwise recycled, asphalt concrete pieces and pavement grindings may be



used in embankments and road shoulders when these materials are placed where they will not enter watercourses or storm drains. Do not place recycled road materials in the stream bank.

- 8) Report to County Engineering the locations of cutslopes and fillslopes that appear to be failing or contributing significant amounts of sediment to streams so that maintenance/repair may be prioritized.

BMP TOOLBOX

Planning and Prevention BMPs

- ✓ Seasonal Planning
- ✓ Small Spill Kit

Erosion Control BMPs

- ✓ Mulching
- ✓ Planting
- ✓ Seeding

Sediment Control BMPs

- ✓ Storm Drain Inlet Protection
- ✓ Silt Mat/Vegetated Grassy Swale
- ✓ Sand Bag

* Note: Some of these are temporary measures that need to be removed upon completion of work and replaced with more permanent structures. See Appendix A for details on removal.

PERMITS

5.4 SHOULDER MAINTENANCE	
Activity or Condition	Required permit or limitation
Any re-grading in sensitive habitat areas	Consult with CDFG or NOAA





5.5 ROADSIDE DITCHES

DESCRIPTION

Roadside ditches carry runoff to designated outfall locations. They are periodically cleaned, reshaped, or stabilized. Ditch maintenance activities include: shoulder blading and rebuilding to correct rutting; reshaping of ditches to maintain the flowline and centerline or to improve the carrying capacity; mowing; and removal of weeds and built-up materials to maintain proper grade or capacity. Follow-up activities include hauling and disposal of excess soil, debris or vegetation to an appropriate spoils disposal location.

Although ditches are considered utilitarian, built for the purpose of draining water from roads, they may contain wetland vegetation and may be classified as “jurisdictional wetlands or Waters of the U.S. Additionally, if a natural drainage channel that is a “Water of the U.S.” (e.g. an ephemeral stream) flows into drainage ditch, the ditch thereby becomes a Water of the U.S. Examples of Waters of the U.S. include tidal drainage ditches and ditches through wetlands.

ENVIRONMENTAL CONCERNS

- ✓ Delivery of sediment related to ditch maintenance to streams or watercourses from:
 - runoff that flows into the ditch
 - erosion within the ditch itself
 - erosion adjacent to the road *or*
 - road failure due to a plugged ditch or ditch relief culvert
- ✓ Excessive erosion or stream channel changes due to concentrated water runoff from a ditch into a watercourse, often exceeding the channels normal carrying capacity.
- ✓ Harm to aquatic habitat during ditch maintenance.
- ✓ Loss of wetland vegetation.
- ✓ Disposal of spoils and debris from ditch maintenance where materials may enter a waterway.

BMP OBJECTIVES

- ✓ Avoid sediment delivery from ditches into connected watercourses.
- ✓ Disconnect drainage ditches from stream channels to reduce potential for sediment delivery and stream channel changes.
- ✓ Stabilize bare soils after maintenance.
- ✓ For unpaved roads, eliminate ditches and ditch relief culverts utilizing outsloping with rolling dips, wherever possible.



BEST MANAGEMENT PRACTICES

- 1) Schedule ditch activity in dry conditions. Avoid working in wet conditions or the wet season, except for emergencies. Due to direct proximity and connectivity, rain and flooding greatly increase the risk of sediment and pollutant runoff.
- 2) Grade ditches only when necessary to keep the ditchline free flowing and restore capacity. Unnecessary mechanical grading can cause excess erosion, undermine banks, and expose the toe of the cutslope to erosion or slope failure.
- 3) Avoid removing more grass and vegetation than necessary.
 - To control vegetation (rather than remove it entirely), use methods like mowing or weed-whacking when feasible. Vegetation prevents scour and filters out sediment.
 - Whenever feasible, maintain a buffer of vegetation between the ditch and the road. This helps filter sediment from runoff and can be accomplished by using a steeper angle on the grader blade.
 - Avoid harming existing vegetation on the cutbank above the ditch to reduce erosion and prevent slope failure.
- 4) Stabilize bare soils after maintenance. Ground disturbance activities within drainage ways have a high potential for causing sediment discharges. To reduce or prevent erosion in retained ditches:
 - rip-rap with appropriate sized rock
 - cover crop
 - apply well-anchored matting or geofabric (e.g. as ditch lining)
 - apply a hardened surface such as asphaltic cement or concrete
- 5) When “pulling” a ditch (mechanically grading and removing fine sediment), avoid spreading ditch spoils across or into the surface rock of the road or shoulder. Consider removing sediment and debris using vacuum trucks as an alternative.
- 6) Dispose of all materials from ditch cleaning at designated sites or acceptable roadside areas (see *Chapter 7.3 - Spoils Handling and Disposal* regarding acceptable disposal of excess materials).
- 7) Avoid sidecasting of soil in all cases where it could be delivered into a watercourse, riparian area, roadside ditch or storm drain. Do not sidecast outside of the County right-of-way, without landowner’s permission. In some instances, under the following guidelines (See Table below), sidecasting is allowable given remote distances from spoils storage sites. In these cases, the setback distance required depends on slope and vegetation. The presence of vegetation helps to slow the travel of sediment downslope, so good judgment is needed to assess the situation. *Do not sidecast at all* if the slope is



sparsely vegetated and it appears that sediment will travel with rain runoff into a stream or estuary system, even if setback distances are applied. On slopes of 5:1 (20% gradient) or less, sidecasting is allowed beyond 150 feet of a watercourse, stream crossing, riparian area, roadside ditch or storm drain. On 2:1 slopes (50%) or less, sidecasting is allowed beyond 300 feet of a watercourse, stream crossing, riparian area, roadside ditch or storm drain. On slopes greater than 2:1, typically sidecasting is *not allowed at all*, however there may be rare instances on slopes greater than 2:1 where sidecasting is acceptable given very long distances from waterbodies and good vegetative cover. Seek advice from local fisheries agency staff when in doubt. Avoid concentrating sidecasting repeatedly in the same place. Never sidecast large amounts of soil from major landslides.

SLOPE GRADIENT	DISTANCE FROM WATERCOURSE, STREAM CROSSING, RIPARIAN AREA, ROADSIDE DITCH, STORM DRAIN	SIDECASTING RULE
Any slope	Appears that sediment will travel with rainwater into watercourse.	Not allowed
5:1 (20%) or less	150 feet or more	Allowed using good judgment
2:1 (50%) or less	300 feet or more	Allowed using good judgment
Greater than 5:1 (50%)	Vegetated slope long distance from watercourse	Allowed
Greater than 5:1 (50%)	Sparsely vegetated slope and it appears that sediment will travel with rain into watercourse	Not allowed

- 8) To the extent practical, employ proper cross drain designs and spacing to retain water in its drainage of origin. See 5.6 - *Drainage Systems* for recommended minimum drainage spacing for different soil types.
- 9) When constructing or reconstructing a ditch, work with designs for outlet locations and terrain, that avoid directly dumping ditch water into surface waters, when practical. If not practical, implement Sediment Management BMPs such as check dams, sand and gravel bag barriers and other acceptable techniques to trap sediment before it reaches a stream. Remove temporary BMPs and replace with permanent BMPs as soon as practical
- 10) Be alert for abnormal ditch water (e.g. summer months or high flow during winter months), which may be indicative of other issues. Try to find the source of the water first. There may be an adjacent spring exposed in the bank cut and thus have biological resources that need addressing or a failed ditch relief culvert upslope that needs fixing.



- 11) Implement routine maintenance for sediment trapping BMPS to ensure they maintain their function. Initially, check BMPs after each storm event. If BMPs are performing adequately, reduce frequency of checks to annually or after major (e.g., 10-year) storm events.
- 12) For ditches with ongoing sedimentation problems, it may be more cost-effective and environmentally less damaging to implement upslope erosion control BMPs to reduce sediment delivery into ditches, rather than conducting seasonal ditch “pulling”. Sediment traps are another alternative.

BMP TOOLBOX

Planning and Prevention BMPs

- ✓ Seasonal Planning
- ✓ Small Spill Kit

Culvert BMPs

- ✓ Culvert Hydraulics Diagram
- ✓ Culvert Plugging Diagram
- ✓ Energy Dissipater
- ✓ Culvert Inlet Sediment Trap

Road Drainage

- ✓ Ditch Relief Culvert

Sediment Control BMPs

- ✓ Storm Drain Inlet Protection
- ✓ Silt Mat/Vegetated Grassy Swale
- ✓ Sand Bag
- ✓ Siltation Pond/Settling Pond

* Note: Some of these are temporary measures that need to be removed upon completion of work and replaced with more permanent structures. See Appendix A for details on removal.

PERMITS



5.5 ROADSIDE DITCHES

Activity or Condition	Required permit or limitation
<p>Reshaping of ditch to other than original dimensions and configuration if:</p> <ul style="list-style-type: none"> • ditch itself is a Water of the U.S. • a natural drainage channel that is a “Water of the U.S.” (e.g. an ephemeral stream) flows into drainage ditch; the ditch thereby becomes a Water of the U.S. <p>Examples of Waters of the U.S.:</p> <ul style="list-style-type: none"> • Tidal drainage ditches and ditches through wetlands • An ephemeral stream – triggers this permit requirement if it has an Ordinary High Water Mark (OHWM) as defined in 33 CFR 328.3(e)] 	<p>(If in doubt as to whether permit is required, consult with COE.)</p> <p>CWA 404 permit; specifically, the COE’s Nationwide Permit 41, “Reshaping Existing Drainage Ditches”. This permit is subject to the following conditions:</p> <ul style="list-style-type: none"> • Ditch must be returned to its original dimensions and configuration • Design capacity or area drained cannot be expanded • Centerline of reshaped ditch must be essentially in the same location as existing ditch’s centerline • County must notify COE if portion reshaped is greater than 500 feet in length <p>Note: This permit does <i>not</i> authorize reconstruction of drainage ditches that have become ineffective through lack of regular maintenance.</p> <p>CWA 401 Water Quality Certification permit from the RWQCB (always required with 404 permit)</p>
<p>Cleaning only (including removal of sediment, debris and vegetation), without reshaping.</p> <p>A ditch that only collects rainfall off the road is not jurisdictional water, and permitting is not required for any maintenance</p>	<p>Exempt from CWA 404 permit process; cleaning is considered maintenance only. However, the ditch must maintain its original dimensions and configuration.</p>
<p>In a Coastal Zone:</p> <ul style="list-style-type: none"> • Any work subject to review under Section 1601 of the Fish and Game Code <p><i>and/or</i></p> <ul style="list-style-type: none"> • Excavation or disposal of fill is outside of the roadway prism 	<p>Coastal development permit</p> <p>(Other than listed activities, ditch maintenance work is exempt from this permit requirement.)</p>





5.6 DRAINAGE SYSTEMS

DESCRIPTION

Drainage system maintenance includes inspection, repair or replacement of components: including retention facilities, pollution control devices, manholes, catch basins, inlets, vaults, drains, and cross drains. For the purpose of this manual, culverts and crossings constructed in natural stream channels are discussed separately in *Chapter 6 – Working In or Near Stream Streams*. Ditch maintenance is also discussed separately in *5.5 - Roadside Ditches*.

While these structures are not naturally occurring watercourses, streams or wetlands, some storm or surface water runoff facilities become wetlands, or were wetlands prior to their conversion, and are regulated as “jurisdictional wetlands” or Waters of the State. (See *Chapter 6 – Working In Or Near Streams*).

ENVIRONMENTAL CONCERNS

- ✓ Discharge of sediment or debris to streams or watercourses.
- ✓ Water pollution from leakage of petroleum products from equipment used for maintenance.
- ✓ Plugging that results in stream crossing diversion.
- ✓ Excessive erosion resulting from alteration of natural hydrologic patterns.
- ✓ Increased peak flows due to runoff from impermeable surfaces.

BMP OBJECTIVES

- ✓ Minimize road-related sedimentation.
- ✓ Reduce sedimentation to watercourses.
- ✓ Reduce stormwater pollution.
- ✓ Preserve or improve surface drainage characteristics in the vicinity of the road.

BEST MANAGEMENT PRACTICES

- 1) Perform routine maintenance and repairs during the dry season whenever possible. If work must be performed during the rainy season, perform work during dry weather. Report erosion problems to county engineers for repairs.



- 2) Stabilize disturbed or bare soils around work areas with Erosion Control BMPs. Stabilize bare soils after maintenance. Ground disturbance activities within drainage ways have a high potential for causing sediment discharges. Implement Sediment Control BMPs at drainage system features as necessary during maintenance to reduce downstream discharge of sediment.
- 3) Inspect critical and problem culverts, drain inlets, and detention facilities annually before the rainy season (prior to October 15th), and after the first major rainfall event (2 year event), when feasible. Inspect suspected problematic culverts as necessary after that, depending on intensity and frequency of rain events.
- 4) Crews should determine the possible presence of California red-legged frogs, Santa Cruz long-toed salamanders (Santa Cruz/Monterey), and San Francisco garter snakes (northern Santa Cruz/San Mateo) before removing vegetation from drainage ditches.). Additionally, where practicable, the Counties should remove vegetation by hand and with the use of small hand tools.
- 5) When vegetation removal or reduction is necessary, dispose of waste according to county standards (see *Chapter 8- Vegetation Management*).
- 6) If using herbicides close to the “normal” start of the rainy season or in early springtime, use only aquatic approved formulations (e.g. Rodeo/Aquamaster with Agridex or LI-700 surfactant, not Round-Up). Timing, rate and volume of spraying should be included in a schedule for herbicide treatment. See Chapter 8-Vegetation Management for details and when in doubt, contact your County Agricultural Commissioner’s office.
- 7) Look for opportunities to restore natural drainage patterns. Install culverts or rolling dips to retain water in its drainage of origin, which will decrease the potential for erosion downstream. On problem roads, look for opportunities to reconstruct the road segment to improve and maintain natural drainage patterns; for example, add rolling dips, emergency water bars and additional cross drains. (See *5.1- Road Treatment and Design Principles*).
- 8) The recommended minimum diameter for all new culverts, including cross drains, but exclusive of driveway culverts, is 18 inches. Often, small diameter culverts (12 inches or less) plug with debris, causing significant road damage. They are also difficult to clean out. In addition, all culverts on anadromous fish bearing streams should be sized for the 100-year storm event and then upsized to accommodate sediment and debris transport volume (See Chapters *5.1- Road Treatment and Design Principles* and *6.2- Culvert Cleaning, Repair and Replacement*).
- 9) Implement energy dissipation BMPs at cross drain outlets to prevent erosion. Discharges from cross drains onto road fill or other erosive areas often cause significant erosion and slope failure. Make sure that newly-installed cross drains are properly designed to minimize erosion problems. Where erosion is already occurring, work to halt and reverse it with appropriate erosion control BMPs.



- 10) Clean cross drains as needed; including clearing vegetation and sediment immediately upslope or downslope of the drain if needed. Consider removing sediment and debris using vacuum trucks as an alternative, where applicable.

SEDIMENT BASINS, SILTATION PONDS AND SEDIMENT TRAPS

- 11) Monitor accumulation of sediment in the sediment basins or siltation ponds. Manage water release from ponds to maximize sediment retention and eventual removal. Develop and implement a routine maintenance schedule for cleaning sediment trapping BMPs to ensure they maintain their function. Keep structures clear of litter and debris and dispose of appropriately.
- 12) If function of the system is compromised by sediment accumulation and removal of sediment is warranted, dispose of appropriately (see *Chapter 7.3-Spoils Handling and Disposal*).

BMP TOOLBOX

Planning and Prevention BMPs

- ✓ Seasonal Planning
- ✓ Small Spill Kit

Culvert BMPs

- ✓ Culvert Hydraulics Diagram
- ✓ Culvert Plugging Diagram
- ✓ Energy Dissipater
- ✓ Culvert Inlet Sediment Trap

Road Drainage

- ✓ Ditch Relief Culvert

Erosion Control BMPs

- ✓ Blankets/Geotextile Fabrics
- ✓ Coir Log/Roll
- ✓ Mulching
- ✓ Planting
- ✓ Plastic Covering
- ✓ Rock Breast Wall
- ✓ Seeding
- ✓ Surface Roughening & Soil Tracking
- ✓ Stepped or Terraced Slope
- ✓ Coir Log/Straw Roll

Sediment Control BMPs

- ✓ Storm Drain Inlet Protection
- ✓ Silt Mat/Vegetated Grassy Swale
- ✓ Sand Bag
- ✓ Silt Fence



- ✓ Siltation Pond/Settling Pond
- ✓ Turbidity Curtain

* Note: Some of these are temporary measures that need to be removed upon completion of work and replaced with more permanent structures. See Appendix A for details on removal.

PERMITS

5.6 DRAINAGE SYSTEMS	
Activity or Condition	Required permit or limitation
<ul style="list-style-type: none"> • Drainage system feature being worked on is in a ditch that qualifies as a Water of the U.S. <i>and</i> • activity alters the shape or configuration of the ditch or drainage feature. If drainage system has temporary measures, such as a coffer dam (BMP), a 404 permit is required if fill is being placed within the ordinary high water mark. <p>(See discussion regarding permit applicability in 5.5- <i>Roadside Ditches</i>.)</p>	<ul style="list-style-type: none"> • CWA Section 404 permit • CWA 401 Water Quality Certification permit from RWQCB (required with CWA 404 permit)
<ul style="list-style-type: none"> • Cleaning only (including removal of sediment, debris and vegetation), with no reshaping of ditch. 	<ul style="list-style-type: none"> • Cleaning is considered maintenance only and is always exempt from the CWA 404 permit process; however, the ditch must maintain its original dimensions and configuration.
<ul style="list-style-type: none"> • In a Coastal Zone, drainage system maintenance work 	<p>Exempt from a Coastal Development Permit unless:</p> <ul style="list-style-type: none"> • subject to review under Section 1600 of the Fish and Game Code, <p><i>or</i></p> <p>excavation or disposal of fill is outside of the roadway prism.</p> <p>Coastal Development Permit is needed in stated cases</p>
<ul style="list-style-type: none"> • Any work covered by local regulations. 	<p>Consult local agencies about additional local permits.</p>



5.7 STREET SURFACE CLEANING

DESCRIPTION

Street cleaning activities are performed to provide a safe roadway surface for the public and to keep sediment and debris from accumulating on the roadway or in the gutters and getting washed into watercourses via stormdrains. Street cleaning typically consists of sweeping with pickup sweeper units and to a lesser extent power brooms and washing with water trucks.

ENVIRONMENTAL CONCERNS

- ✓ Discharge of the following materials into the storm water drainage system or watercourses:
 - Litter and debris
 - Equipment wash water
 - Sediment and pollutants from the road surface

BMP OBJECTIVES

- ✓ Reduce amount of sediment, organics, chemicals, and debris entering watercourses.
- ✓ Reduce potential for airborne emissions from sweeping operations.

BEST MANAGEMENT PRACTICES

- 1) Control sweeper speed to minimize airborne particulates and remove the maximum amount of debris.
- 2) Use the water spray system on the sweeper to reduce dust generation. Prioritize use of pickup sweepers in sensitive areas (e.g., near watercourses) or when large amounts of debris/sediment are present.
- 3) Adjust the brooms frequently to maximize the efficiency of sweeping operations. After pickup sweeping is finished, properly dispose of sweeper wastes at an approved dumpsite.
- 4) Street sweepings are often contaminated with petroleum hydrocarbons and heavy metals including lead, copper, and zinc. **Do not compost sweepings!**
- 5) Watch for the presence of potential hazardous materials so that these can be properly collected and the possibility of spills is reduced.
- 6) Clean sweepers in a maintenance yard or an approved area to capture solid materials.



- 7) Make sure personnel are trained to respond appropriately to hazardous materials that may be encountered and spills that may occur during street cleaning. Carry a spill kit for prompt cleanup of spills (Small Spill Kit BMP), and clean up spills of petroleum products immediately using the appropriate procedures. Notify County Engineering immediately regarding other spills, so that appropriate notification and response may be made. Do not hose down the work area or pour any materials down drains.
- 8) Increase frequency of pickup sweeping as practical.
- 9) When washing down pavement, employ *Erosion Control and Sediment Management BMPs* in adjacent roadside ditches if wash water can reach streams or storm drain systems.

BMP TOOLBOX

Planning and Prevention BMPs

- ✓ Seasonal Planning
- ✓ Small Spill Kit

Sediment Control BMPs

- ✓ Storm Drain Inlet Protection

PERMITS

5.7 STREET CLEANING	
Activity or Condition	Required permit or limitation
Street cleaning in general	Addressed as part of the County’s NPDES General Storm Water Management Permit.



5.8 CONCRETE WORK

DESCRIPTION

Maintenance and repair of concrete surfaces, such as bridges, concrete roadways, sidewalks, driveways, parking lots, and curb and gutter sections are performed to provide a safe roadway for the traveling public; maintain safe pedestrian access; and maintain proper functioning drainage features. Concrete work includes: concrete removal, crack sealing, concrete grinding, saw cutting, replacement of removed sections and installation of new structures.

ENVIRONMENTAL CONCERNS

- ✓ Discharge of the following materials into the storm water drainage system or watercourses:
 - Portland cement concrete (PCC), concrete or cement rinse water, concrete grindings and cuttings, sediment, form release agents.

BMP OBJECTIVES

- ✓ Eliminate run-off of pollutants from maintenance/repair area.
- ✓ Eliminate discharge of sediment to streams and watercourses.
- ✓ Eliminate discharge of concrete debris or rubble resulting from concrete repair work into creeks or waterways. Dispose of debris appropriately.

BEST MANAGEMENT PRACTICES

- 1) Inspect equipment for leaks or damage prior to performing concrete work. Perform maintenance at designated repair facilities.
- 2) Prior to concrete work, identify storm drain inlets, manholes, and watercourses. Protect storm drains with appropriate Sediment Management BMPs.
- 3) Designate areas to be used for concrete washout and perform washout only in properly constructed containments. When washing equipment or vehicles to remove cement or concrete residue, use only as much water as is needed so that rinse water can be properly contained. For example, use a positive shutoff on the washout hose. Construct the washout area in accordance with the Concrete Washout BMP.
- 4) Follow these procedures for concrete mixing on site.
 - Ensure that contractors who fuel and operate cement mixing operations on site have an adequate spill plan and materials for spill containment.
 - Avoid mixing excess amounts of fresh concrete or cement on site..
 - Establish mixing plants outside of riparian corridors or near watercourses..
 - Dry and wet materials should be stored away from waterways and storm drains and should be covered and contained to prevent runoff from rainfall.



- 5) Remove concrete grindings, rubble, and debris from the site for proper disposal and do not discharge into drain inlets, the storm water drainage system or watercourses.
- 6) Contain coolant water from concrete cutting and do not discharge into drain inlets, the storm water drainage system or watercourses.
- 7) When fresh concrete may be exposed to water, (e.g. rainy weather work), use concrete sealants that are approved by the California Department of Fish and Game for this purpose.
- 8) For the duration of concrete work, make inspections an ongoing practice.
 - After rainfall events, inspect drainage protection measures. In the case of an extended storm, inspect at least once per day. If the protection measures are subjected to non-stormwater flows, inspect daily
 - Inspect inlet protection to prevent water from backing up. If back-up occurs, the protection needs to be replaced with an alternative device.
 - Monitor the concrete wash-out, waste storage and disposal sites and on-site procedures at least weekly.
 - Make sure employees and contractors are following pollution control measures.

BMP TOOLBOX

Planning and Prevention BMPs

- ✓ Seasonal Planning
- ✓ Small Spill Kit

Sediment Control BMPs

- ✓ Concrete Containment
- ✓ Concrete Washout
- ✓ Storm Drain Inlet Protection
- ✓ Sand Bag
- ✓ Sedimentation Sump

PERMITS

5.8 CONCRETE WORK	
Activity or Condition	Required permit or limitation
Concrete work in streams and on stream banks	<ul style="list-style-type: none"> • U.S. Army Corps of Engineers 404 Permit • Regional Water Quality Control Board 401 Water Quality Certification • California Department of Fish and Game Streambed Alteration Agreement DFG 1602 • NOAA Fisheries Service consultation
Temporary concrete batch plant	<ul style="list-style-type: none"> • May need County Use Permit



5.9 SNOW AND ICE CONTROL

DESCRIPTION

Road maintenance crews are responsible for sanding, de-icing, and plowing operations during periods of freezing weather. Snow and ice removal is necessary to provide a safe roadway surface for the traveling public. Materials used include sand and sometimes salt.

ENVIRONMENTAL CONCERNS

- ✓ Discharge of sediment (sand and cinders) and de-icing agents into the watercourse or storm water drains.
- ✓ Impacts of particulates from sand and cinders on air quality.
- ✓ Degradation of stream water quality by increased dissolved solids (salts).
- ✓ Salt damage to trees or other vegetation adjacent to a road or in a location affected by runoff.

BMP OBJECTIVES

- ✓ Reduce road-related sediment (including sand and cinders) discharge to sensitive areas and watercourses.
- ✓ Minimize impacts from application of salts and de-icing/anti-icing chemicals.

BEST MANAGEMENT PRACTICES

- 1) Minimize use of salt by reducing salt to sand ratios to the maximum extent feasible (See Snow and Ice Control BMP referenced below).
- 2) Use road abrasives that have been washed, screened, or graded to reduce silt and clay content.
- 3) Remove sand and salts from road immediately after snow and ice has melted, if practical and advisable from a safety perspective.
- 4) Plow snow into areas that allow vegetation to filter and contain sand.
- 5) Prioritize clean up efforts to aquatic habitat areas once road safety hazard due to snow and ice is gone.



- 6) Prioritize clean up areas without sediment collection systems.

BMP TOOLBOX

Sediment Management BMPs

- ✓ Storm Drain Inlet Protection
- ✓ Sedimentation Sump
- ✓ Siltation Pond/Settling Pond
- ✓ Sweeping

Planning and Prevention BMPs

- ✓ Seasonal Planning
- ✓ Small Spill Kit

PERMITS

5.9 SNOW AND ICE CONTROL	
Activity or Condition	Required permit or limitation
Sanding	None
Chemical use	May need to be addressed as part of the County's NPDES General Storm Water Management Permit



CHAPTER 6
WORKING IN AND AROUND STREAM CHANNELS

6.1 General Principles.....6-3

6.2 Culvert Cleaning, Repair and Replacement.....6-9

6.3 Woody Debris.....6-17

6.4 Stream Bank Stabilization.....6-19

6.5 Dewatering.....6-23

6.6 Low Water Crossing Installation and Maintenance.....6-29





6.1 General Principles for Working In or Near Stream Channels

DESCRIPTION

Note- The maintenance practices covered in this chapter *do not* include channel maintenance or flood control activities. For information on flood control or channel maintenance BMPs, please refer to Flood Control Facility Maintenance Manual developed by the Bay Area Stormwater Management Agencies Association (BASMAA, June 2000).

This chapter *does* provide aquatic protection guidelines when performing road maintenance activities in or near stream channels, ponds, estuaries and wetlands. Activities include culvert cleaning, repair and replacement, streambank stabilization, woody debris management, dewatering and low water crossings. While some of these activities might be considered *projects*, versus *routine maintenance*, we felt it was critical to expand the scope of this chapter to cover these important subjects which are critical to salmon fisheries protection and restoration (e.g. culvert replacement for fish passage). Adopting best management practices when conducting routine maintenance or implementing projects in or near the streams, is the first line of defense for protecting salmon fisheries and other aquatic life.

In this chapter we refer to channels as *natural watercourses* that provide aquatic habitat for salmonids, or are connected to streams that do so. Culverts and crossings on natural stream channels are covered in 6.2 - *Culvert Cleaning, Repair and Replacement*. For the purpose of this manual, cross drains and roadside ditches are considered separately from natural channels. Although ditches often function similarly to channels, and may be considered Waters of the U.S. under certain conditions, they are part of a man-made road system and are covered in *Chapter 5.5- Roadside Ditches*. Cross drain culverts are covered in *Chapter 5.6 - Drainage Systems*.

ENVIRONMENTAL CONCERNS

- ✓ Discharge of sediment or debris to streams or watercourses.
- ✓ Harm to instream aquatic habitat or aquatic species.
- ✓ Harm to riparian areas and riparian species.
- ✓ Alteration of natural channel function or shape or destabilization of stream banks.
- ✓ Water pollution from equipment operation.
- ✓ Alteration of stream hydraulics and diversion of stream energies that may cause downstream erosion or structural damage.
- ✓ Dewatering of stream or stream segments.
- ✓ Loss of instream habitat due to wood removal.

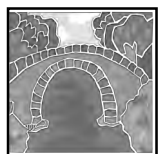

BMP OBJECTIVES

- ✓ Protect water quality by reducing erosion and sedimentation.
- ✓ Avoid negative impacts to aquatic and riparian habitat and species.
- ✓ Maintain or restore fish passage.

BEST MANAGEMENT PRACTICES

- 1) Schedule channel-related road maintenance work during the dry season, avoiding periods which may be more harmful to fish or other aquatic species of concern, such as California red-legged frogs, Santa Cruz long-toed salamanders, and San Francisco garter snakes. Consult local Fish and Game or U.S. Fish and Wildlife biologists to ensure compliance with seasonal constraints. For further details per species see Seasonal Planning BMP.

Measures to Minimize Disturbance From Instream Construction¹

- 2) Construction should generally occur during the lowest flow period of the year.
- 3) Construction should occur during the dry period if the channel is seasonally dry.
- 4) Prevent any construction debris from falling into the stream channel. Any material that does fall into a stream during construction should be immediately removed in a manner that has minimal impact to the streambed and water quality.
- 5) Where feasible, the construction should occur from the bank, or on a temporary pad underlain with filter fabric.
- 6) Temporary fill must be removed in its entirety prior to close of work-window.
- 7) Areas for fuel storage, refueling, and servicing of construction equipment must be located in an upland location.
- 8) Prior to use, clean all equipment to remove external oil, grease, dirt, or mud.
- 9) Wash sites must be located in upland locations so that dirty wash water does not flow into stream channel or wetlands.
- 10) All construction equipment must be in good working condition, showing no signs of fuel or oil leaks.
- 11) Petroleum products, fresh cement, or deleterious materials must not enter the stream channel.
- 12) Operators must have spill clean-up supplies on site and be knowledgeable in their proper use and deployment.

¹ CALIFORNIA SALMONID STREAM HABITAT RESTORATION MANUAL; Chapter IX Fish Passage Evaluation. April 2003 Guidance to Minimize Impacts During Stream Crossing Construction.

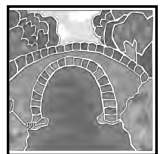

- 13) In the event of a spill, operators must immediately cease work, start clean-up, and notify the appropriate authorities.

Measures to Minimize Degradation of Water Quality²

- 14) Isolate the construction area from flowing water until project materials are installed and erosion protection is in place.
- 15) Erosion control measures shall be in place at all times during construction. Do not start construction until all temporary control devices (straw bales, silt fences, etc.) are in place downslope or downstream of project site.
- 16) Maintain a supply of erosion control materials onsite, to facilitate a quick response to unanticipated storm events or emergencies.
- 17) Use erosion controls to protect and stabilize stockpiles and exposed soils to prevent movement of materials. Use devices such as plastic sheeting held down with rocks or sandbags over stockpiles, silt fences, or berms of hay bales to minimize movement of exposed or stockpiled soils.
- 18) Stockpile excavated material in areas where it cannot enter the stream channel.
- 19) Prior to start of construction, determine if such sites are available at or near the project location. If unavailable, determine location where material will be deposited. If feasible, conserve topsoil for reuse at project location or use in other areas.
- 20) Minimize temporary stockpiling of excavated material.
- 21) When needed, utilize instream grade control structures to control channel scour, sediment routing, and headwall cutting.
- 22) Immediately after project completion and before close of seasonal work window, stabilize all exposed soil with mulch, seeding, and/or placement of erosion control blankets.

Measures to Minimize Loss or Disturbance of Riparian Vegetation³

- 23) Prior to construction, determine locations and equipment access points that minimize riparian disturbance. Avoid affecting less stable areas.
- 24) Retain as much understory brush and as many trees as feasible, emphasizing shade producing and bank stabilizing vegetation.

² CALIFORNIA SALMONID STREAM HABITAT RESTORATION MANUAL; Chapter IX Fish Passage Evaluation. April 2003 Guidance to Minimize Impacts Suring Stream Crossing Construction.

³ CALIFORNIA SALMONID STREAM HABITAT RESTORATION MANUAL; Chapter IX Fish Passage Evaluation. April 2003 Guidance to Minimize Impacts Suring Stream Crossing Construction.

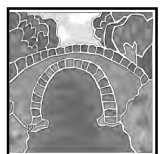

- 25) Minimize soil compaction by using equipment with a greater reach or that exerts less pressure per square inch on the ground, resulting in less overall area disturbed or less compaction of disturbed areas.
- 26) If riparian vegetation is to be removed with chainsaws, consider using saws currently available that operate with vegetable-based bar oil.
- 27) Decomact disturbed soils at project completion as the heavy equipment exits the construction area.
- 28) Revegetate disturbed and decompacted areas, with native species specific to the project location that comprise a diverse community of woody and herbaceous species.

Measures to Minimize Impacts to Aquatic Habitat and Species During Dewatering of Project Site - See Dewatering Chapter 6.5

BMP TOOLBOX

Streambank Protection - Biotechnical BMPs

- ✓ Brush Mattress
- ✓ Joint Planting
- ✓ Large Woody Debris Revetment
- ✓ Willow Wall Revetment
- ✓ Live Fascine
- ✓ Live Stakes
- ✓ Fabric Reinforced Earth Fill with Brush Layering

Streambank Protection - Hardscape BMPs

- ✓ Boulder/Riprap
- ✓ Vegetated Concrete Cribwall
- ✓ Streambed Gravel

Water Management BMPs

- ✓ Aqua Barrier
- ✓ Cofferd Dam
- ✓ Dewatering
- ✓ Diversion Berm
- ✓ Rolling Dip
- ✓ Sandbag
- ✓ Slope Drain – Temporary
- ✓ Slope Drain – Overside
- ✓ Stream Bypass

Erosion / Sediment Control BMPs

- ✓ Silt Fence
- ✓ Turbidity Curtain
- ✓ Branch Packing
- ✓

Culvert BMPs

- ✓ Energy Dissipater

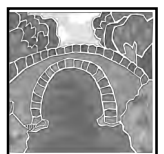

Planning and Prevention BMPs

- ✓ Seasonal Planning

PERMITS

6.1 GENERAL PRINCIPLES- WORKING IN AND AROUND STREAM CHANNELS	
Activity or Condition	Required permit or limitation
<ul style="list-style-type: none"> • Replacing riprap • Removing or altering large woody debris (non-emergency debris maintenance) <p><i>or</i></p> <ul style="list-style-type: none"> • Otherwise altering a channel 	<ul style="list-style-type: none"> • CWA 404 - COE • CWA 401 – RWQCB • DFG 1601 • NOAA Fisheries consultation
<p>In a Coastal Zone, work is exempt from a coastal development permit unless:</p> <ul style="list-style-type: none"> • subject to review under Section 1601 of the Fish and Game Code • excavation or disposal of fill is outside of the roadway prism 	<p>Coastal Zone Development Permit (County or City planning department)</p>
<p>BMPs that may involve “take”; these include dewatering, coffer dams, diversion berms, and stream bypass structures.</p>	<ul style="list-style-type: none"> • (NOAA Fisheries or USFWS) ESA Section 10 Incidental Take Permit • (DFG) CESA Section 2081 Incidental Take Permit

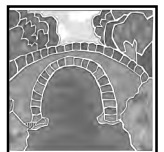



6.2 CULVERT CLEANING, REPAIR AND REPLACEMENT AT STREAM CROSSINGS

DESCRIPTION

Water Quality- Culverts, bridges, and other stream crossing structures must be periodically maintained or replaced to preserve their function of passing stream flows and wood, to prevent flooding, to prevent damage to the structure, and to avoid sediment inputs to the stream channel by eroding or "blown-out" culverts. Using best management practices when maintaining these structures will help In a "first line defense" to protect and improve water quality. Best Management Practices in *Section 6.1- General Principles for Working In or Near Stream Channels* should be adhered to during routine culvert maintenance or project implementation.

Stream Crossings on Salmon Streams- Many of today's culverts were installed long ago on salmonid bearing streams before standards were developed for fish passage. Many of these culverts now present problems for salmon who need to swim upstream to spawn or find colder water in the upper tributaries during hot summer months. Fish passage barriers also cause problems when juvenile salmon leave the river to migrate out to sea in the spring. FishNet counties, with the support of the Department of Fish and Game and the Coastal Conservancy, have completed fish passage assessments for county structures on salmonid bearing streams. These studies have helped Public Works Departments develop priority lists for replacing and renovating culverts or other crossings to provide fish passage.⁴

Fish Passage Projects- The best management practices presented in this chapter will assist county staff in preparing projects for fish passage in consultation with permitting agencies. Appendix C includes two essential references for fish passage projects: Guidelines for Salmonid Passage at Stream Crossings, NOAA Fisheries 2001 and Culvert Criteria for Fish Passage; CDFG Salmonid Stream Habitat Restoration Manual; CH IX 2002.

Cross Drains and Culverts on Non-Fish Bearing Streams- Standards for culverts on fish bearing streams are subject to different rules from culverts and cross-drains on non-fish bearing streams. California Department of Fish and Game and NOAA Salmonid Passage Guidelines in Appendix C apply only to culverts on streams with salmonid habitat. Other drainage design guidelines (Caltans, ASHTO, etc.) apply to culverts and cross-drains on non-salmon bearing streams. Best Management Practices for these structures are covered in the Roads Chapter; Section 5.6- Drainage Systems.

⁴ Taylor and Assoc. (June 2003). Marin County Stream Crossing Inventory and Fish Passage Evaluation-. Taylor and Assoc. (March 31, 2003). Sonoma and Mendocino Counties Russian River Stream Crossing Inventory and Fish Passage Evaluation.

Taylor and Assoc. (January 2004) County of Santa Cruz Stream Crossing Inventory and Fish Passage Evaluation.

Taylor and Assoc. (April 2004) San Mateo County Stream Crossing Inventory and Fish Passage Evaluation.

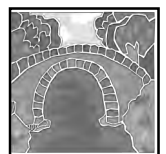

ENVIRONMENTAL CONCERNS

- ✓ Discharge of sediment or debris to streams or watercourses.
- ✓ Impeding or altering fish or amphibian passage.
- ✓ Altered flows (e.g. by dewatering), changes in channel shape, (e.g. widening by removal of sandbars and vegetation), changes in channel carrying capacity or ability to pass debris, increased potential for flooding, or damage to road or other structures.
- ✓ Harm to aquatic or riparian vegetation, or aquatic or riparian species; for example removing sediment from a culvert in a watercourse that has fish may directly harm salmonids or their habitat.

BMP OBJECTIVES

- ✓ Restore or improve fish passage for all life stages of salmonids, providing fish access to valuable upstream habitat.
- ✓ Improve channel's ability to convey debris flows, including sediment, gravel, cobbles and woody debris, without removing sandbars and vegetation (which often leads to channel widening).
- ✓ Upgrade size of new and replacement culverts to 100-year storm capacity on salmonid streams as permitted.
- ✓ Restore or improve stream flow conveyance function of culverts.
- ✓ Properly identify potential blockages based on fish passage assessment criteria approved by DFG.
- ✓ Reduce potential for erosion at stream crossings.
- ✓ Protect streambank root habitat and riparian vegetation

BEST MANAGEMENT PRACTICES

CULVERT CLEANING

- 1) Inspect culverts and other crossings annually before the rainy season (prior to October 15th), and after the first major rainfall event (2 year event), when feasible. Inspect suspected problematic culverts as necessary after that, depending on intensity and frequency of rain events.
- 2) Schedule work to take into account the life cycles of salmon and steelhead and any other pertinent threatened or endangered species such as California red-legged frogs, Santa Cruz long-toed salamanders, and San Francisco garter snakes. Consult with agency biologists to identify seasonal work restrictions or limitations on procedures to protect threatened or endangered species in your area.
- 3) Perform all work in dry conditions, and do not work in flowing waters. If a stream is flowing, use Cofferdam or Dewatering BMPs as needed.

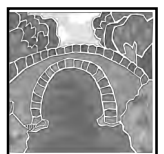

- 4) Identify riparian areas and potential fish habitat before cleaning culverts. Consult with appropriate staff or agency biologists if you have questions about the extent of riparian areas or presence of fish at the crossing.
- 5) Exercise caution when using equipment in riparian areas and potential fish habitat. Inspect equipment for leaks, damage and buildup of oils and grease prior to performing work. Monitor frequently for leaks and equipment failure, and avoid causing damage to vegetation, sandbars, and surrounding environment. If leaks are detected during operation, equipment should be immediately removed from the area, and the spill properly cleaned. (For important details on using equipment in the field, see *Chapter 5.2- Paved Roads*).
- 6) Stream crossing maintenance should *not* include sediment or vegetation removal to increase channel capacity for flood flow, unless permitted as a specific activity. Minimize stream channel disturbance by avoiding removal of sediment and vegetation within the county right of way where possible.
- 7) Report to supervisors the locations of culverts that appear damaged, may impede fish passage, or may cause erosion, noted during routine cleaning. This is a critical first step to protecting fish-bearing streams. NOAA Fisheries and DFG have established fish passage criteria for culverts. Typical problems to watch for during inspection of culverts and other crossings are:⁵
 - Excessive velocities in a culvert (culvert set at too steep a slope for juvenile fish to swim through at high flows);
 - Lack of water depth in a culvert;
 - Perched culvert outlet (i.e. outlet is physically above the stream bed);
 - Lack of depth in an outlet pool preventing fish from jumping up into culvert;
 - Obstructions within a culvert; and
 - Physical damage to fish from deteriorating and jagged corrugated metal.
- 8) Dispose of all sediment and debris from culvert cleaning according to *Chapter 7.3- Spoils Handling and Disposal*. Never dispose of material along the banks or in the floodplain where it could be delivered back to the channel during the next rainstorm.

CULVERT REPAIR AND REPLACEMENT

- 1) Schedule culvert repair or replacement during the dry season (between April 15th and October 15th). Do not perform culvert repair or replacement in wet conditions or during the rainy season unless permitted. Rain and flooding greatly increase the risk of pollutant runoff.
- 2) Schedule work to take into account the life cycles of salmon and steelhead and any other pertinent threatened or endangered species such as California red-legged frogs, Santa Cruz long-toed salamanders, and San Francisco garter snakes. Consult with agency biologists to identify seasonal work restrictions or limitations on procedures to protect

⁵ CALIFORNIA SALMONID STREAM HABITAT RESTORATION MANUAL; Chapter IX Fish Passage Evaluation. April 2003 Guidance to Minimize Impacts Suring Stream Crossing Construction.

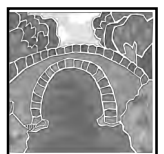

threatened or endangered species in your area. These limitations will be part of the permits you will need to complete this work.

- 3) Before replacing or altering culverts or bridges on fish-bearing streams, consult appropriate engineering and design staff familiar with NOAA Fisheries and DFG criteria found in Appendix C- *Guidelines for Salmonid Passage at Stream Crossings*, NOAA, 2001. The proposed design and mitigations will be part of the NOAA Fisheries and DFG permit applications. Fish passage can be computed by Roads Engineers by using Fish Xing Software for culvert design and assessment, at <http://www.fs.fed.us.fishxing/> See Appendix A Culvert BMPs for additional information as well.
- 4) Options for anadromous fish-bearing stream crossings, in order of preference are: (Sources include: Bates et al. 1999; Robison et al. 2000; NOAA, 2001.)
 - a) No crossing – realign road to avoid crossing the stream.
 - b) Bridge spanning the stream to allow for long-term dynamic channel stability; making sure there is no encroachment into the channel or 100-year flood plain. When installing or replacing a stream crossing, bridges are strongly preferred for fish-bearing streams.
 - c) Streambed simulation strategies: Bottomless arch, embedded culvert, or ford.
 - d) Culvert set below stream-grade (countersunk or embedded).
 - e) Non-embedded culvert set at a low gradient (less than 0.5%) to allow for fish passage.
 - f) Baffled culvert, or structure designed with a fishway – for steeper slopes (greater than 0.5%). Baffles are not generally recommended because they require continual clearing of debris and maintenance to function properly, and require a longer, more difficult permit process.
 - g) Culvert set at grade with baffles installed to allow low-flow passage and reduced velocities during higher migration flows.
 - h) Culvert perched with outlet pool weirs and baffles throughout culvert. Entry jumps should never exceed 1 foot for adults or 0.5 feet for juveniles.
- 5) Design criteria for anadromous fish-bearing stream crossings' proper sizing and alignment are: (Bates et al. 1999; Robison et al. 2000)
 - Pass a 100-year storm flow at less than 100 percent of the culvert's height, to allow passage of large wood and channel substrate during high flows.
 - Culvert width sized at least equal to active channel width, or ordinary high water flow (OHW), which is approximately at line of annual vegetation growth. Reduce or eliminate constriction of flows at the inlet associated with fish migration.
 - Avoid projecting culvert inlets.
 - Align culvert with upstream channel direction – avoid sharp bends in channel at approach to inlet.
 - If there are channel constraints at the crossing, the culvert is likely undersized or placed in an inappropriate location.
 - Avoid installing trash racks at culvert inlets.
 - Use channel alterations judiciously and avoid channel confinement in fish-bearing streams.

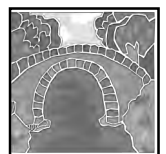

- 6) Implement appropriate Water Management and Culvert BMPs while replacing or retrofitting culverts, and Streambank Protection BMPs and Erosion and Sediment Control BMPs to control sediment discharge during work. See list at end of section and Appendix A for detailed BMPs.
- 7) When restoring the surrounding site after culvert replacement or retrofitting, stabilize the work area and prevent erosion by using appropriate Streambank Protection BMPs and Erosion Control BMPs.
- 8) Use of biotechnical BMPs and native vegetation is preferable over hardscape techniques when appropriate for the site conditions and engineering constraints. For biotechnical BMPs that require the establishment of vegetative cover, plan and implement ongoing vegetation maintenance and irrigation as needed.
- 9) When using hardscape BMPs for streambank stabilization, work to incorporate planting of trees, shrubs or erosion control grasses into designs.
- 10) In pools downstream of culverts, bridges, and other structures, always leave vegetation to provide cooling shade, shelter and cover for aquatic animals. (See *Chapter 8-Vegetation Management*.)
- 11) Using Water and Sediment Management BMPs, capture runoff from bridge structures with long or wide spans.
- 12) After completion of construction, monitor the performance of long-term BMPs periodically, particularly after significant storm events. Perform immediate repairs or upgrades as necessary.
- 13) Perform maintenance only in the vicinity of the crossing (i.e. within the road right-of-way).

BMP TOOLBOX

Valuable References

- ✓ For the latest guidelines on fish passage criteria and inventory methodologies, go to www.dfg.ca.gov or <http://swr.nmfs.noaa.gov>
- ✓ See Appendix C for :
Department of Fish and Game. (Flosi et al 2001). “Fish Passage Criteria and Guidelines” (Chapter X). California Salmonid Stream Habitat Restoration Manual
NOAA Fisheries (2001). Guidelines for Salmonid Passage on Stream Crossings.

Planning and Prevention BMPs

- ✓ Seasonal Planning

Culvert BMPs

- ✓ Culvert Hydraulics Diagram
- ✓ Culvert Plugging Diagram
- ✓ Back-Flooding Weirs

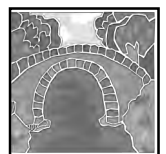

- ✓ Baffles for Fish Passage Improvement
- ✓ Ditch Relief Culvert
- ✓ Energy Dissipator
- ✓ Culvert Inlet Sediment Trap
- ✓ Culvert Sizing

Streambank Protection - Preferred Biotechnical BMPs

- ✓ Brush Mattress
- ✓ Joint Planting
- ✓ Large Woody Debris
- ✓ Live Fascine
- ✓ Live Stakes
- ✓ Fabric Reinforced Earth Fill with Brush Layering

Streambank Protection - Hardscape BMPs

- ✓ Boulder/Riprap
- ✓ Vegetated Concrete Cribwall
- ✓ Streambed Gravel

Water Management BMPs

- ✓ Aqua Barrier
- ✓ Cofferd Dam
- ✓ Dewatering (Pumping or Draining)
- ✓ Diversion Berm
- ✓ Rolling Dip
- ✓ Sandbag
- ✓ Stream Bypass

Erosion / Sediment Control BMPs

- ✓ Silt Fence
- ✓ Turbidity Curtain
- ✓ Energy Dissipator
- ✓ Concrete Containment

PERMITS

Before replacing or altering culverts or bridges, consult agency biologists and obtain appropriate permits from DFG, RWQCB, COE, and NOAA Fisheries. In stream channels with anadromous fish habitat, state and federal permits require culverts be designed for fish passage of all life stages of salmon. DFG's Fish Passage Criteria and Guidelines (Chapter X, DFG Stream Restoration Manual) address the passage needs of all aquatic animals, not just anadromous fish. NOAA Fisheries': Guidelines for Salmonid Passage on Stream Crossings, address the needs of migrating salmonid fish. (See *Appendix C* for complete technical papers).

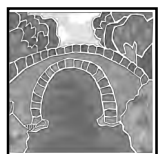

6.2 CULVERT CLEANING, REPAIR AND REPLACEMENT

Activity or Condition	Required permit or limitation
Culvert replacement.	<p>(DFG) Fish & Game Code Section 1602 Streambed Alteration Agreement with CEQA compliance. Maintenance requires an annual or multi-year agreement.</p> <p>CESA 2081 incidental take permit from DFG if state-listed <i>endangered</i> species are in the stream and if an ESA Section 10 incidental take permit has not already been obtained.</p> <p>RWQCB CWA 401 permit</p> <p>Under CWA 404, consultation with NOAA Fisheries and/or US Fish and Wildlife Service, (through the ACOE) is triggered under ESA Section 7, for federally-funded and permitted activities. Take authority is required if take of listed salmonid species might occur.</p>
Placement of any fill in streams (e.g. rock in pools below culverts), or any material into wetlands.	U.S. Army COE 404 CWA
Sediment reduction projects at stream crossings with potential to affect fish passage	<p>Under CWA 404:</p> <ul style="list-style-type: none"> • NOAA Fisheries consultation, triggered under ESA Section 7 for federally-funded and permitted activities <p><i>and either</i></p> <ul style="list-style-type: none"> • (COE) General-Nationwide Permit (#14) – “Linear Sediment Reduction Projects at Water Crossings” <p><i>or</i></p> <ul style="list-style-type: none"> • (COE) General-Regional Permit (#1) – “Fish Passage / Sediment Reduction Projects at Water Crossings”
<p>Activities in the Coastal Zone are exempt from permit unless:</p> <ul style="list-style-type: none"> • subject to review under Section 1601 of the Fish and Game Code, 	Coastal development permit from County or City Planning Departments.

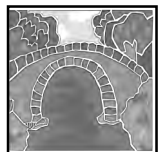

6.2 CULVERT CLEANING, REPAIR AND REPLACEMENT

Activity or Condition	Required permit or limitation
<i>or</i> <ul style="list-style-type: none">excavation or disposal of fill is outside of the roadway prism.	



6.3 WOODY DEBRIS

DESCRIPTION

A healthy salmon stream is chock full of large wood- big logs and rootwads, that dig into the banks and help form the channel's complexity.- making pools and providing food and shelter. Wood is a key link in the ecosystem of salmon. Restorationists and public agencies have taken on the task of placing large woody debris structures into creeks to benefit salmon. While restoration certainly helps, *our goal in this section is to provide guidelines on how to keep wood in the creek in the first place.*

Large Woody Debris (LWD), is defined as stumps, rootwads and logs having an average diameter greater than 6 inches and a length greater than 10 feet (**need ref.**). When we refer to woody debris management it is best to think about *modification*, rather than removal, whenever feasible. Removal of wood from creeks has such a negative impact on salmon, that as a general practice, it should not be done unless there is a very real threat to county property or public safety. Best Management practices outlined below will help guide crews in avoiding or minimizing this impact.

One of the very best ways to allow wood to stay in the creek is to maintain culverts and bridges that pass the 100-year flood flows. This ensures that large debris flows will also pass, creating more natural channel conditions overall. See *6.2 Culvert Cleaning, Repair and Replacement*.

Note: The maintenance practices covered in this section *do not* include traditional channel maintenance or flood control activities. For information on flood control or channel maintenance BMPs, please refer to [Flood Control Facility Maintenance Manual](#) developed by the Bay Area Stormwater Management Agencies Association (BASMAA, June 2000).

ENVIRONMENTAL CONCERNS

- ✓ Loss of instream habitat due to wood removal.
- ✓ Harm to instream aquatic habitat or aquatic species.
- ✓ Harm to riparian areas and riparian species.
- ✓ Alteration of natural channel function or shape or destabilization of stream banks.
- ✓ Water pollution from equipment operation.
- ✓ Alteration of stream hydraulics and diversion of stream energies that may cause downstream erosion or structural damage.

BMP OBJECTIVES

- ✓ Preserve and protect important woody debris in creeks to the extent possible.
- ✓ Prevent potential water pollution from equipment operations.

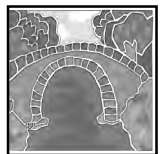

BEST MANAGEMENT PRACTICES

- 1) Only remove (as opposed to modify) logs and debris from streams as a “last resort” when accumulation of debris poses a threat to road stability and bridges, culverts or other instream structures.
- 2) Have both a biologist and an engineer conduct a full review of the situation. The biologist should be familiar with the life histories and habitat needs of federally listed plants and animals in the area and be able to identify any of the life stages of these species. If in doubt as to the best way to handle large woody debris in a stream, consult with DFG personnel.
- 3) If log jams immediately threaten, or are damaging the integrity of roads, bridges, other public facilities during high flows, consider opportunities to *modify* the debris jam to halt damage and direct flow toward a more desirable path.
- 4) Take precautions to ensure that modifications of logs or debris jams will not cause damage downstream to culverts and other structures.
- 5) Limit modifications and/or removal to materials that extend higher than approximately two feet above the streambed (i.e. above knee height) to preserve some instream habitat features, *unless* the log or debris jam is immediately upstream and threatening a culvert or bridge, or if permit conditions require otherwise.
- 6) When modifying log jams, leave trees, logs and/or stumps in the longest lengths and diameters practicable for removal and hauling. If logs must be cut from fallen trees, leave as much as possible of the main trunk (12 feet plus is desirable) attached to the rootball and only cut branches obstructing flow. Log jams create suitable habitat for California red-legged frogs and San Francisco garter snakes and so where applicable this should be considered before removing or modifying any logjams.
- 7) Whenever feasible, incorporate LWD removed from water bodies into streambank repairs or cribbing at a nearby location, and/or transport any removed LWD to an approved storage site and make available for later use (e.g. in stream restoration activities).

BMP TOOLBOX

Planning and Prevention BMPs

- ✓ Seasonal Planning

PERMITS

6.3 WOODY DEBRIS	
Activity or Condition	Required permit or limitation
Removing or modifying large woody debris	Consult with DFG biologists

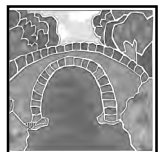

6.4 STREAM BANK STABILIZATION

DESCRIPTION

Every one of our counties has heritage roads that wind along the edge of some of our most important salmon streams. Our crews, as part of their work to maintain these road, need to implement streambank stabilization projects, in order to repair road-related slipouts, washouts, and slides. When the stream is so nearby, it is especially critical to consider bio-engineered alternatives, in order to create streambank habitat that salmon need to survive. Bio-engineering also allows a more natural channel and prevents scour of downstream areas. While these activities might be considered *projects*, versus *routine maintenance*, we felt it was critical to expand the scope of this chapter to cover this important subject which is critical to stream and salmon fisheries protection.

Activities may include:

- removal of slide debris from the bank, channel, or roadway,
- construction of terraces with willow walls or other bioengineered solutions,
- construction of crib walls or retaining structures,
- use of rip rap or other hardscape materials,
- backfilling or reshaping the bank,
- re-establishing damaged roadway features,
- repairing and cleaning drainage systems, and
- applying erosion controls,
- replanting and monitoring of revegetation.

Bank stabilization may be an emergency response to mitigate ongoing or imminent damage, or a planned project. Refer to *Chapter 10.2- Emergency Slide and Washout Repair* for bank stabilization activities under Emergency Conditions.

ENVIRONMENTAL CONCERNS

- ✓ Discharge of sediment or debris to streams or watercourses.
- ✓ Harm to or loss of streamside aquatic habitat.
- ✓ Harm to or loss of riparian areas.
- ✓ Water pollution from equipment operations.
- ✓ Hardening of streambank channel and alteration in channel hydraulics that may increase water velocities and downstream erosional forces, and lead to loss of riparian habitat.

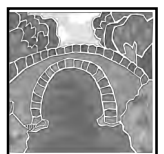

BMP OBJECTIVES

- ✓ Protect water quality by reducing erosion/sedimentation.
- ✓ Prevent potential water pollution from equipment operations.
- ✓ Encourage revegetation to stabilize slope and protect aquatic and riparian habitat.

BEST MANAGEMENT PRACTICES

- 1) Schedule work to take into account the life cycles of salmon and steelhead and any other pertinent threatened or endangered species such as California red-legged frogs, Santa Cruz long-toed salamanders, and San Francisco garter snakes. Consult with agency biologists to identify seasonal work restrictions or limitations on procedures to protect threatened or endangered species in your area. These limitations will be part of the permits you will need to complete this work.
- 2) In order to create a natural streambank environment, use biotechnical repairs, versus riprap or other hardscape repairs, if site conditions allow.
- 3) Inspect equipment for leaks, damage and buildup of oils and grease prior to performing work; and perform maintenance at designated repair facilities. If equipment must be refueled in the field, perform fueling in identified staging areas well away from stream or riparian areas and maintain an absorbent spill kit.
- 4) Implement appropriate Erosion Control and Water and Sediment Management BMPs as referenced in the BMP Toolbox section below during bank stabilization projects.
- 5) Set up the work and staging area to minimize the area of soil that will be disturbed and the tracking of soil out of the work area by vehicles and equipment. Avoid staging projects in areas where runoff will be concentrated or may run into a watercourse.
- 6) When installation of riprap or other hardscape repairs is required to protect structures:
 - Consult with qualified engineering or planning staff about the appropriate size of hardscape protection needed, the appropriate placement techniques, and the potential usage of biotechnical protection in conjunction with the hardscape protection;
 - Attempt to limit hardscape protection to below the ordinary high water mark;
 - Incorporate plantings, designed to allow tree growth, into hardscape designs; and
 - Key into the bank as appropriate.
- 7) Minimize erosion and impacts to bank toe during stabilization by:⁶
 - leaving as much vegetation as possible
 - using downstream energy dissipation features such as pools or grade control structures, and other protection BMPs such as coir logs, riparian enhancement

⁶ Santa Clara Valley Water District. (December 2001). [SFRWQCB Tentative Order Appendix C. Stream Maintenance Program, Implementation of Best Management Practices.](#)

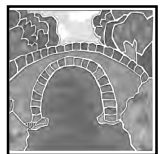

planting, strategic placement of rock, and flow deflectors. Hardscape often causes increased flow velocity at bank protection sites, thereby increasing erosion downstream. (For more information on appropriate Erosion Control, Water and Sediment Management BMPs. (see *BMP Toolbox* below, and *Chapter 7- Erosion Control – General.*)

- 8) When excavating slide material, minimize the size of the disturbed area by removing only the amount of slide debris needed to prevent future slope failure and delivery of material to the stream. Dispose of slide debris and other spoils according to procedures discussed in *Chapter 7- Sediment Management, Section 7.2- Spoils Handling and Disposal.*
- 9) For biotechnical BMPs that require the establishment of vegetative cover, plan and implement ongoing vegetation monitoring, maintenance and irrigation as needed.
- 10) After completing construction, monitor the performance of long-term BMPs periodically, particularly after significant storm events. Perform immediate repairs or upgrades as necessary.

BMP TOOLBOX

Planning and Prevention BMPs

- ✓ Seasonal Planning

Streambank Protection - Preferred Biotechnical BMPs

- ✓ Brushmattress
- ✓ Joint Planting
- ✓ Large Woody Debris
- ✓ Live Fascine
- ✓ Live Stakes
- ✓ Fabric Reinforced Earth Fill with Brush Layering

Streambank Protection - Hardscape BMPs

- ✓ Boulder/Riprap
- ✓ Streambed Gravel

Water Management BMPs

- ✓ Aqua Barrier
- ✓ Cofferd Dam
- ✓ Dewatering
- ✓ Diversion Berm
- ✓ Rolling Dip
- ✓ Sandbag
- ✓ Slope Drain – Temporary
- ✓ Slope Drain – Overside
- ✓ Stream Bypass

Erosion / Sediment Control BMPs

- ✓ Silt Fence
- ✓ Brushpacking

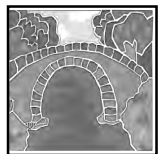

- ✓ Turbidity Curtain
- ✓ Energy Dissipator

PERMITS

6.4 STREAM BANK STABILIZATION	
Activity or Condition	Required permit or limitation
Any non-emergency bank stabilization work	Complete <i>before</i> work starts: <ul style="list-style-type: none"> • U.S. Army Corps of Engineers 404 Permit • Regional Water Quality Control Board 401 Water Quality Certification • California Department of Fish and Game Streambed Alteration Agreement 1602. • NOAA Fisheries consultation
Emergency work	See <i>Chapter 10.2- Emergency Slide and Washout Repair</i> , for documentation protocol and permit requirements.

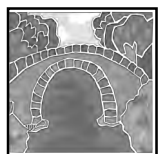

6.5 DEWATERING

DESCRIPTION

Dewatering is the removal of water from the work area. The purpose is to prevent water from interfering with the work (e.g., excavation, bank stabilization, etc.), and to prevent the discharge of contaminants such as suspended sediment and concrete. Dewatering may include damming, creating a stream bypass, pumping or draining. The dewatering of anadromous fish streams must be conducted in consultation with the Department of Fish and Game and NOAA fisheries. A fisheries biologist with state and federal “take” permits will be required to be on-site to relocate any salmonids that become stranded during the dewatering process. An individual project permit may include incidental take requirements specific to the dewatering process.

ENVIRONMENTAL CONCERNS

- ✓ Discharge of sediment or debris to streams or watercourses.
- ✓ Harm to instream aquatic habitat or aquatic species such as fish and amphibians
- ✓ Temporal disruption of fish passage.

BMP OBJECTIVES

- ✓ Protect water quality by reducing erosion and sedimentation.
- ✓ Avoid negative impacts to aquatic and riparian habitat and species.
- ✓ Maintain or restore fish passage.

BEST MANAGEMENT PRACTICES

- 1) Consult with agency biologists and obtain necessary permits before beginning project (see *Permits* below). Schedule work to take into account the life cycles of salmon and steelhead and any other pertinent threatened or endangered species such as California red-legged frogs, Santa Cruz long-toed salamanders, and San Francisco garter snakes. Consult with agency biologists to identify seasonal work restrictions or limitations on procedures to protect threatened or endangered species in your area. These limitations will be part of the permits you will need to complete this work.
- 2) If anadromous salmonids are present a fisheries biologist needs to be on site to begin netting fish and moving them downstream as dewatering proceeds.
- 3) Intakes and outlets should be designed to minimize turbidity and the potential to wash contaminants into the stream.
- 4) If a work site is to be temporarily dewatered by pumping, intakes should be completely screened with wire mesh not larger than 5 millimeters to prevent amphibians from entering the pump system.

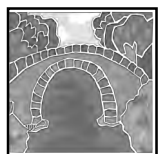

- 5) A filtration/settling system must be included to reduce downstream turbidity (i.e. filter fabric, turbidity curtain). The selection of an appropriate system is based on the rate of discharge. If feasible, water that is pumped into a pipe should discharge onto the top of bank into a densely vegetated area. This may require extra hose length.
- 6) Note pre-construction grade prior to placement and return channel bottom, cofferdam areas and discharge sites to preconstruction grades.
- 7) Once the project work is complete, release water slowly back into the work area to prevent erosion and increased turbidity.

Dewatering BMPs from Fisheries Grants Program Regional General Permit/ Neg/Dec⁷

- 8) Work must be performed in isolation from the flowing stream. If there is any flow when the work is done, the operator shall construct coffer dams upstream and downstream of the excavation site and divert all flow from upstream of the upstream dam to downstream of the downstream dam. The coffer dams may be constructed with clean river gravel or sand bags, and may be sealed with sheet plastic. Sand bags and any sheet plastic shall be removed from the stream upon project completion. Clean river gravel may be left in the stream, but the coffer dams must be breached to return the stream flow to its natural channel.
- 9) For minor actions, where the disturbance to construct coffer dams to isolate the work site would be greater than to complete the action (for example, placement of a single boulder cluster), measures will be put in place immediately downstream of the work site to capture suspended sediment. This may include installation of silt catchment fences across the stream, or placement of a filter berm of clean river gravel. Silt fences and other non-native materials will be removed from the stream following completion of the activity. Remove sediment behind the silt fence before removing the fence. Gravel berms may be left in place after breaching, provided they do not impede the stream flow.
- 10) If it is necessary to divert flow around the work site, either by pump or by gravity flow, the suction end of the intake pipe shall be fitted with fish screens meeting DFG and NMFS criteria to prevent entrainment or impingement of small fish. Any turbid water pumped from the work site itself to maintain it in a dewatered state shall be disposed of in an upland location where it will not drain directly into any stream channel.
- 11) Measures shall be taken to minimize harm and mortality to listed salmonids resulting from fish relocation and dewatering activities:
 - a) Fish relocation and dewatering activities shall only occur between June 15 and November 1 of each year.
 - b) DFG shall minimize the amount of wetted stream channel that is dewatered at each individual project site to the fullest extent possible.
 - c) All electrofishing shall be performed by a qualified fisheries biologist and conducted according to the National Marine Fisheries Service *Guidelines for Electrofishing Waters Containing Salmonids Listed Under the Endangered Species Act*, June 2000.

⁷ Mitigation Measures, Monitoring and Reporting Program for the 2005 Fisheries Restoration Grant Program; Appendix B. California Department of Fish and Game.

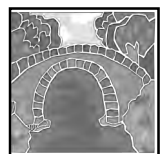

Measures to Minimize Impacts to Aquatic Habitat and Species During Dewatering of Project Site⁸

- 12) Prior to dewatering, determine the best means to bypass flow through the work area to minimize disturbance to the channel and avoid direct mortality of fish and other aquatic vertebrates.
- 13) Coordinate project site dewatering with a fisheries biologist qualified to perform fish and amphibian relocation activities.
- 14) Minimize the length of the dewatered stream channel and duration of dewatering.
- 15) Bypass stream flow around work area, but maintain stream flow to channel below construction site.
- 16) The work area must often be periodically pumped dry of seepage. Place pumps in flat areas, well away from the stream channel. Secure pumps by tying off to a tree or stake in place to prevent movement by vibration. Refuel in area well away from stream channel and place fuel absorbent mats under pump while refueling. Pump intakes should be covered with 1/8" mesh to prevent entrainment of fish or amphibians that failed to be removed. Check intake periodically for impingement of fish or amphibians.
- 17) Discharge wastewater from construction area to an upland location where it will not drain sediment-laden water back to stream channel.

Measures to Minimize Injury and Mortality of Fish and Amphibian Species During Dewatering⁹

Prior to dewatering a construction site, fish and amphibian species should be captured and relocated to avoid direct mortality and minimize take. This is especially important if listed species are present within the project site. The following measures are consistent with those defined as *reasonable and prudent* by NOAA for projects concerning several northern California Evolutionary Significant Units for coho salmon, chinook salmon, and steelhead trout.

- 18) Fish relocation activities must be performed only by qualified fisheries biologists, with a current DFG collectors permit, and experience with fish capture and handling. Check with your local DFG biologist for assistance.
- 19) In regions of California with high summer air temperatures, perform relocation activities during morning periods.
- 20) Periodically measure air and water temperatures. Cease activities when water temperatures exceed temperatures allowed by DFG and NOAA.

⁸ CALIFORNIA SALMONID STREAM HABITAT RESTORATION MANUAL FISH PASSAGE EVALUATION CH IX April 2003 Guidance to Minimize Impacts Suring Stream Crossing Construction.

⁹ same

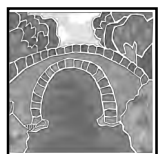

- 21) Exclude fish from re-entering work area by blocking the stream channel above and below the work area with fine-meshed net or screens. Mesh should be no greater than 1/8 inch. It is vital to completely secure bottom edge of net or screen to channel bed to prevent fish from re-entering work area. Exclusion screening should be placed in areas of low water velocity to minimize impingement of fish. Screens should be checked periodically and cleaned of debris to permit free flow of water.
- 22) Prior to capturing fish, determine the most appropriate release location(s). Consider the following when selecting release site(s):
 - a. Similar water temperature as capture location
 - b. Ample habitat for captured fish
 - c. Low likelihood of fish re-entering work site or becoming impinged on exclusion net or screen.
- 23) Determine the most efficient means for capturing fish. Complex stream habitat generally requires the use of electrofishing equipment, whereas in outlet pools, fish may be concentrated by pumping-down pool and then seining or dipnetting fish.
- 24) Electrofishing should only be conducted by properly trained personnel following DFG and NOAA guidelines.
- 25) Minimize handling of salmonids. However, when handling is necessary, always wet hands or nets prior to touching fish.
- 26) Temporarily hold fish in cool, shaded, aerated water in a container with a lid.
- 27) Provide aeration with a battery-powered external bubbler. Protect fish from jostling and noise and do not remove fish from this container until time of release.
- 28) Place a thermometer in holding containers and, if necessary, periodically conduct partial water changes to maintain a stable water temperature. If water temperature reaches or exceeds those allowed by DFG and NOAA, fish should be released and rescue operations ceased.
- 29) Avoid overcrowding in containers. Have at least two containers and segregate young-of-year (YOY) fish from larger age-classes to avoid predation. Place larger amphibians, such as Pacific giant salamanders, in container with larger fish.
- 30) If fish are abundant, periodically cease capture, and release fish at predetermined locations.
- 31) Visually identify species and estimate year-classes of fish at time of release.
- 32) Count and record the number of fish captured. Avoid anesthetizing or measuring fish.
- 33) Submit reports of fish relocation activities to DFG and NOAA in a timely fashion.
- 34) If feasible, plan on performing initial fish relocation efforts several days prior to the start of construction. This provides the fisheries biologist an opportunity to return to the work

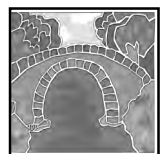

area and perform additional electrofishing passes immediately prior to construction. In many instances, additional fish will be captured that eluded the previous days efforts.

- 35) If mortality during relocation exceeds 5 percent, stop efforts and immediately contact the appropriate agencies.

BMP TOOLBOX

Water Management BMPs

- ✓ Cofferd Dam
- ✓ Aqua Barrier
- ✓ Dewatering (pumping or draining)
- ✓ Stream Bypass

Planning and Prevention BMPs

- ✓ Seasonal Planning

Erosion / Sediment Control BMPs

- ✓ Silt Fence
- ✓ Turbidity Curtain
- ✓ Energy dissipator

PERMITS

6.5 DEWATERING	
Activity or Condition	Required permit or limitation
Installation of dewatering system in concurrence with a stream bank and/or channel activity	<ul style="list-style-type: none"> • U.S. Army Corps of Engineers 404 Permit • Regional Water Quality Control Board 401 Water Quality Certification • Consult DFG biologists and obtain Streambed Alteration Agreement DFG1602 and 2081 incidental Take Permit with CESA/CEQA compliance if anadromous salmonids are present. • NOAA Fisheries Consultation

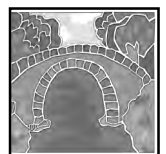



6.7 LOW WATER CROSSING INSTALLATION AND MAINTENANCE

DESCRIPTION

Temporary stream crossings are used to allow vehicles to cross a drainage or stream without entering the water. Placing temporary stream crossings, typically during the summer or dry season, can protect sensitive areas subject to vehicle traffic by minimizing impacts to the stream bottom, and reducing erosion. Regrading and slope stabilization are necessary during installation and removal of the crossing and occasionally as maintenance activities when the crossings are impacted by excessive vehicle traffic or flooding.

The installation of low water crossings on salmon streams is a highly regulated type of project, subject to Federal and State ESA and Clean Water Act provisions. During the permit process, you will be working with agency biologists, hydrologists, fish passage experts etc., to develop protections for the stream channel and fish, from installation – maintenance - to removal. The FishNet 4C program recognizes that permanent structures, allowing for fish passage and channel forming flows, are much more desirable than low water crossings. We encourage our counties to seek solutions to low water crossings, prioritizing important salmon streams first.

See California Salmonid Stream Habitat Restoration Manual (CDFG Chapter X, 4th Edition Armored Fill)

ENVIRONMENTAL CONCERNS

- ✓ Discharge of sediment to streams or watercourses, particularly washing of fine materials from crossing into stream.
- ✓ Harm to aquatic habitat.
- ✓ Harm to riparian areas.
- ✓ Water pollution from equipment operations and vehicle traffic.
- ✓ Impeding fish passage.
- ✓ Alteration of channel hydraulics and subsequent downstream effects.

BMP OBJECTIVES

- ✓ Minimize disturbance to the stream or waterway.
- ✓ Protect water quality by reducing erosion/sedimentation.
- ✓ Prevent potential water pollution from equipment operations.
- ✓ Eliminate fish barriers.

BEST MANAGEMENT PRACTICES

- 1) Consult with appropriate agencies to obtain permits for installation and removal of crossings (see *Permits* below). During both installation and removal of crossings, keep equipment out of flowing waters.

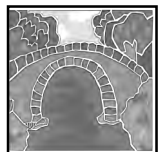

- 2) Schedule work to take into account the life cycles of salmon and steelhead and any other pertinent threatened or endangered species such as California red-legged frogs, Santa Cruz long-toed salamanders, and San Francisco garter snakes. Low water crossings on salmonid streams are only permitted by NOAA Fisheries between June 8th and October 15th.
- 3) Consult with county road engineers on the appropriate number and size of culverts incorporated into a crossing. Consult with county and agency fish passage engineers (NOAA, DFG) on meeting fish passage criteria through these culverts. (See *Chapter 6.2 Culvert Cleaning, Repair and Replacement* and *Appendix A- Culvert Sizing and Appendix C- Guidelines for Salmonid Passage at Stream Crossings, NOAA, 2001*).
- 4) If dewatering is necessary during construction, consult a qualified fisheries biologist, apply for appropriate permits, and implement appropriate fish removal and dewatering BMPs. (See *Chapter 6.5 Dewatering*.)
- 5) Best Management Practices (BMPs) for sediment and turbidity control should be implemented and in place prior to, during, and after construction in order to ensure that no silt or sediment enters surface waters. Appropriate erosion and sediment control measures should be implemented immediately after removal is complete.
- 6) All project related construction work should incorporate appropriate BMPs, including stabilizing and seeding disturbed upland slopes and stockpiles situated landward and above of ordinary high water, to control and minimize bank erosion, sediment input and turbidity during the winter and spring months.
- 7) When a temporary culvert is installed, if needed, place appropriate geotextile or cellular confinement (honeycomb) fabric in the gravel bed at the downstream outlet to reduce erosion from the water flowing through the culvert. Do not use plastic netting.
- 8) Fill material placed in the stream to create the base for the crossings should be clean river gravel. Material placed above water level may be a road base allowing for compaction and a suitable driving surface. Clean river gravel may be left in the river to wash out during high winter flows. Road base or material containing a high level of fines above water level should be removed from the channel below the level of 'ordinary high water'. This material may be stored above the level of 'ordinary high water' to be used in subsequent years.
- 9) Upstream and downstream turbidity should be measured at each crossing before, during and after installation and removal. Monitor the downstream area for sediment or fine material washing off the crossing.
- 10) Do not treat the crossing with oil or other material that may pollute the stream, or use chemically treated materials (e.g. creosote-treated wood) to construct the crossing unless the material or treatment is certified safe for use in aquatic habitat.
- 11) Following the removal of the crossing the constructed roadbeds should be largely removed to reestablish the approximate contour, elevation, and condition of the affected bar area that existed prior to the seasonal roadbed construction. All excavated material should be hauled and stockpiled landward and above ordinary high water. The effected bars should be fine-graded to remove any pits and depressions that could otherwise

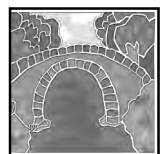

entrap salmonid fish species and to ensure positive drainage to the low-flow channel. Where roadbeds are constructed in flowing water, the dredged or fill material should be removed only to an elevation of two feet above the water level to minimize turbidity and sedimentation. If gravel is used, skim it off as low as possible without entering the flowing water. Trenches may be dug in the gravels to allow winter flows to break through the gravel.

BMP TOOLBOX

Culvert BMPs

- ✓ Culvert Hydraulics Diagram
- ✓ Energy Dissipator
- ✓ Culvert Inlet Sediment Trap

Water Management BMPs

- ✓ Aqua Barrier
- ✓ Cofferd Dam
- ✓ Dewatering
- ✓ Diversion Berm
- ✓ Stream Bypass

Erosion / Sediment Control BMPs

- ✓ Silt Fence
- ✓ Turbidity Curtain
- ✓ Blankets/Geotextile Fabrics
- ✓ Coir Log/Roll
- ✓ Planting
- ✓ Seeding

PERMITS

6.6 Low Water Crossing Installation And Maintenance	
Activity or Condition	Required permit or limitation
Installation or removal of temporary stream crossings, including dewatering.	<ul style="list-style-type: none"> • U.S. Army Corps of Engineers 404 Permit • Regional Water Quality Control Board 401 Water Quality Certification • California Department of Fish and Game Streambed Alteration Agreement DFG1602 and 2081 incidental Take Permit with CESA/CEQA compliance. • NOAA Fisheries Service Consultation • Consult with county engineering or planning on appropriate size and design of structure.

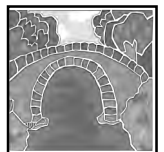





CHAPTER 7
EROSION CONTROL AND SEDIMENT MANAGEMENT

7.1 Sediment Control- General Principles..... 7-3

7.2 Minor Slide Repair..... 7-9

7.3 Spoils Handling and Disposal..... 7-15





7.1 SEDIMENT CONTROL – GENERAL PRINCIPLES

DESCRIPTION

Controlling erosion and managing the run-off of sediment is a “first line of defense” action in protecting water quality and salmonid habitat. Salmon lay their eggs in nests of streambed gravels (redds), burying them deep in the substrate of the channel. The flow of water and the oxygen it brings with it, are critical to the survival of the eggs and the young salmon that hatch from them. If the gravels are clogged or embedded with sediment, the eggs can smother from lack of oxygen or become toxic with metabolic waste that cannot be flushed from the gravels. Sediment can also negatively impact instream insect populations, causing further harm to aquatic wildlife further up the food chain. Excessive sediment in our streams is one of the key factors in the decline of salmon populations on our coast.

This chapter emphasizes the importance of implementing erosion control to keep sediment on-site, avoiding run-off situations whenever possible. We also provide tools for controlling run-off, in order to keep mobile sediment out of our rivers and wetlands.

Erosion control is an integral part of all phases in the life of county maintenance projects, including:

- (a) planning;
- (b) control of run off and sediment coming onto or leaving the site during construction; (*temporary BMPs*),
- (c) incorporation of appropriate BMPs into constructed infrastructure (*permanent BMPs*); and
- (d) monitoring/maintenance or removal of temporary BMPs after the project is complete.

ENVIRONMENTAL CONCERNS

- ✓ Discharge of sediment or debris to streams or watercourses.
- ✓ Alteration of stream channel shape and function through erosion and/or sedimentation.
- ✓ Damage to or destruction of riparian and aquatic habitat through erosion and/or downstream sedimentation.
- ✓ Lethal and sublethal impacts to salmonids Creation of a barrier to fish passage.
- ✓ Damage to or destruction of upslope vegetation and loss of topsoil.
- ✓ Creation of habitat favorable for noxious weeds or invasive plant species.
- ✓ Progression of erosion processes resulting in catastrophic slope or embankment failure.
- ✓ Damage to or destruction of public infrastructure or natural features.



BMP OBJECTIVES

- ✓ Protect water quality, aquatic habitat and riparian habitat by reducing erosion and sedimentation.
- ✓ Maintain proper functioning of stream channel and in-stream structures.
- ✓ Prevent the formation of fish passage barriers.
- ✓ Maintain healthy riparian and up slope vegetation. Retain topsoil.
- ✓ Avoid erosion before it creates chronic problems or future catastrophic hillslope or embankment failure.

APPROACH AND STANDARDS

- 1) Incorporate erosion control into the planning, construction and follow up phases for all maintenance activities. Review the standards contained in this manual, select applicable BMPs for which materials are available and plan to have the necessary materials on hand for implementation before starting work.
- 2) If working during times when rain might be possible, always have erosion control measures onsite in case of a storm event. Have materials needed for erosion control BMPs available at the site before work is started (125% of what is necessary)
- 3) Plan for projects involving disturbance of soil (earthwork) to occur during the dry season between April 15 and October 15, whenever possible. If work must be performed during the rainy season, work during dry weather conditions whenever possible. Guidelines for necessary unscheduled emergency earthwork conducted during the rainy season (October 15 through April 15) should comply with your county's Grading Ordinance and winter time grading guidelines, if available.
- 4) Use the following hierarchy to select and prioritize the erosion control BMPs referenced below and in Appendix A. Separate planning and prioritization may be required for BMPs implemented only during construction as opposed to BMPs left in place when the project is complete.
 - I) Keep the disturbed area dry and keep water from flowing off-site when possible. Use Water Management BMPs to control or divert run off coming onto or leaving the site.
 - II) Keep sediment in place to the extent possible. Use Erosion Control or Streambank Protection BMPs to stabilize disturbed soil.
 - III) If it is not practical to stop run-off from leaving the site, use Water Management and Sediment Control BMPs to minimize the amount of entrained sediment leaving the site.
 - IV) If it is not possible to stop runoff with entrained sediment from leaving the site, use Sediment Control BMPs to capture the entrained sediment before it is delivered to a stream or watercourse.



- 5) Set up the work and staging area to minimize the area of soil that will be disturbed and the tracking of soil out of the work area by vehicles and equipment. Avoid staging projects in areas where runoff will be concentrated. Do not stage equipment in riparian areas or adjacent to streams. Use the appropriate Erosion and Sediment Control BMPs to secure the staging area.
- 6) Protect storm drain inlets and watercourses using Water Management and Sediment Control BMPs as referenced below.
- 7) Reuse (replace) excavated soil at the site to the extent possible.
- 8) Avoid sidecasting of soil in all cases where it could be delivered into a watercourse, riparian area, roadside ditch or storm drain. Do not sidecast outside of the County right-of-way, without landowner's permission. In some instances, under the following guidelines (See Table below), sidecasting is allowable given remote distances from spoils storage sites. In these cases, the setback distance required depends on slope and vegetation. The presence of vegetation helps to slow the travel of sediment downslope, so good judgment is needed to assess the situation. *Do not sidecast at all* if the slope is sparsely vegetated and it appears that sediment will travel with rain runoff into a stream or estuary system, even if setback distances are applied. On slopes of 5:1 (20% gradient) or less, sidecasting is allowed beyond 150 feet of a watercourse, stream crossing, riparian area, roadside ditch or storm drain. On 2:1 slopes (50%) or less, sidecasting is allowed beyond 300 feet of a watercourse, stream crossing, riparian area, roadside ditch or storm drain. On slopes greater than 2:1, typically sidecasting is *not allowed at all*, however there may be rare instances on slopes greater than 2:1 where sidecasting is acceptable given very long distances from waterbodies and good vegetative cover. Seek advice from local fisheries agency staff when in doubt. Avoid concentrating sidecasting repeatedly in the same place. Never sidecast large amounts of soil from major landslides.

SLOPE GRADIENT	DISTANCE FROM WATERCOURSE, STREAM CROSSING, RIPARIAN AREA, ROADSIDE DITCH, STORM DRAIN	SIDECASTING RULE
Any slope	Appears that sediment will travel with rainwater into watercourse.	Not allowed
5:1 (20%) or less	150 feet or more	Allowed using good judgment



SLOPE GRADIENT	DISTANCE FROM WATERCOURSE, STREAM CROSSING, RIPARIAN AREA, ROADSIDE DITCH, STORM DRAIN	SIDECASTING RULE
2:1 (50%) or less	300 feet or more	Allowed using good judgment
Greater than 5:1 (50%)	Vegetated slope long distance from watercourse	Allowed
Greater than 5:1 (50%)	Sparsely vegetated slope and it appears that sediment will travel with rain into watercourse	Not allowed

- 9) Temporarily stockpile excavated soil away from streams, watercourses or areas where run off will concentrate, until reused or removed to a permanent disposal site. Implement erosion control BMPs on and around stockpiles to keep materials from eroding as outlined in *Chapter 7.3- Spoils Handling and Disposal*.
- 10) The performance of erosion control BMPs should be monitored daily during construction. Added attention should be given to monitoring of BMPs after storm events, and BMPs should be maintained, upgraded or augmented with additional BMPs as needed.
- 11) Projects should not be considered complete until the appropriate long-term erosion control BMPs are in place.
- 12) Use of biotechnical BMPs and native vegetation is preferable over hardscape techniques when appropriate for the site conditions.
- 13) For biotechnical BMPs that require the establishment of vegetative cover, plan and implement ongoing vegetation maintenance and irrigation as needed. Regularly evaluate the replanted area to ensure vegetation is establishing itself. Implement a follow-up revegetation program if the first attempt fails!
- 14) Implement adequate cover cropping or mulching; both are *quick and economic methods* to control or prevent surface erosion.



- 15) After completion of construction, monitor the performance of long-term BMPs periodically, particularly after significant storm events. Perform immediate repairs or upgrades as necessary.

BMP TOOLBOX

Culvert BMPs

- ✓ Energy Dissipater

Erosion Control BMPs

- ✓ Blankets/Geotextile Fabrics
- ✓ Coir Log/Roll
- ✓ Mulching
- ✓ Planting
- ✓ Plastic Covering
- ✓ Rock Breast Wall
- ✓ Seeding
- ✓ Stepped or Terraced Slope
- ✓ Surface Roughening & Soil Tracking

Sediment Management BMPs

- ✓ Sand Bag
- ✓ Sedimentation Sump
- ✓ Silt Fence
- ✓ Silt Mat
- ✓ Siltation Pond/Settling Pond
- ✓ Storm Drain Inlet Protection
- ✓ Sweeping
- ✓ Turbidity Curtain

Water Management BMPs

- ✓ Asphalt Berm
- ✓ Diversion Berm
- ✓ Sandbag
- ✓ Slope Drain – Temporary
- ✓ Slope Drain – Overside
- ✓ Stream Bypass (Water Diversion)

PERMITS

7.1 SEDIMENT CONTROL	
Activity or Condition	Required permit or limitation
• Instream work	• U.S. Army COE 404 CWA
• Instream work	• California Department of Fish and Game 1602



7.1 SEDIMENT CONTROL

Activity or Condition	Required permit or limitation
	Streambed Alteration Agreement
• Bank stabilization	• U.S. Army COE General Nationwide Permit No. 13
• Sediment reduction measures at road and stream crossings	• U.S. Army COE Regional General Permit



7.2 MINOR SLIDE REPAIR

DESCRIPTION

Minor slides, slipouts and washouts are usually caused by the impact of heavy rainfall, concentrated runoff, subsurface water, loss of physical support, or freeze and thaw conditions on unstable or saturated soils. Slides and washouts may occur on the slope above or below roadways, private property, or sensitive areas. Minor slides, slipouts, and washouts are repaired to restore or prevent further damage to roadways and other structures, and sediment delivery to streams and watercourses. Repair of minor slides and washouts includes: clearing materials (soil, rock, organic material and debris) deposited by wind, water, or minor landslides; excavating, recontouring and/or backfilling minor slides, washouts or eroded areas; revegetation and erosion control; repairing damage to roads and other structures; and constructing, repairing or improving drainage facilities. Repair of slides under emergency conditions is discussed in *Chapter 10.2 - Emergency Slide and Washout Repair*. Repair of road slipouts adjacent to streambanks is described in *Chapter 6.4 - Streambank Stabilization*.

ENVIRONMENTAL CONCERNS

- ✓ Delivery of sediment, organic debris, asphalt, and other potential pollutants into the streams, watercourses or storm water drainage systems.
- ✓ Damage to stream or riparian habitat from the slide itself or from heavy equipment use instream or in the riparian zone.
- ✓ Damage to public infrastructure leading to further environmental damage.
- ✓ Water pollution from equipment operations.

BMP OBJECTIVES

- ✓ Protect water quality, aquatic habitat and riparian habitat by reducing erosion and sedimentation.
- ✓ Prevent potential water pollution from equipment operations.
- ✓ Restore and maintain healthy riparian and upslope vegetation. Retain topsoil.

BEST MANAGEMENT PRACTICES

- 1) When a slide impacts a stream system (for example, if the natural flow of a watercourse is changed or habitat is damaged), seek the advice of appropriate experts prior to performing permanent repair work such as:
 - Engineering, environmental and planning staff
 - Resource agency personnel (DFG, NOAA Fisheries, RWQCB)



- Hydrologists or Hydraulic Engineers
 - Geologists
 - Geomorphologists
 - Geotechnical Engineers
 - Fisheries Biologists
- 2) Inspect equipment for leaks, damage and buildup of oils and grease prior to performing work, and perform maintenance at designated repair facilities.
 - 3) To prevent water pollution from equipment operations, use non-organophosphate hydraulic fluid as part of standard operating procedures.
 - 4) Set up the work and staging area to minimize the area of soil that will be disturbed and the tracking of soil out of the work area by vehicles and equipment. Keep equipment out of riparian areas, if possible. Do not stage equipment in riparian areas, adjacent to streams, or in areas where runoff may concentrate or may run into a watercourse. Use the appropriate Erosion Control and Sediment Management BMPs to secure the staging area.
 - 5) During the repair, protect storm drain inlets and watercourses using the Sediment Control BMPs referenced below. Remove temporary BMPs when clean up is completed.
 - 6) Implement Water Management BMPs, as needed to divert runoff around the damaged area.
 - 7) Avoid sidecasting of soil in all cases where it could be delivered into a watercourse, riparian area, roadside ditch or storm drain. Do not sidecast outside of the County right-of-way, without landowner's permission. In some instances, under the following guidelines (See Table below), sidecasting is allowable given remote distances from spoils storage sites. In these cases, the setback distance required depends on slope and vegetation. The presence of vegetation helps to slow the travel of sediment downslope, so good judgment is needed to assess the situation. *Do not sidecast at all* if the slope is sparsely vegetated and it appears that sediment will travel with rain runoff into a stream or estuary system, even if setback distances are applied. On slopes of 5:1 (20% gradient) or less, sidecasting is allowed beyond 150 feet of a watercourse, stream crossing, riparian area, roadside ditch or storm drain. On 2:1 slopes (50%) or less, sidecasting is allowed beyond 300 feet of a watercourse, stream crossing, riparian area, roadside ditch or storm drain. On slopes greater than 2:1, typically sidecasting is *not allowed at all*, however there may be rare instances on slopes greater than 2:1 where sidecasting is acceptable given very long distances from waterbodies and good vegetative cover. Seek advice from local fisheries agency staff when in doubt. Avoid concentrating sidecasting repeatedly in the same place. Never sidecast large amounts of soil from major landslides.



SLOPE GRADIENT	DISTANCE FROM WATERCOURSE, STREAM CROSSING, RIPARIAN AREA, ROADSIDE DITCH, STORM DRAIN	SIDECASTING RULE
Any slope	Appears that sediment will travel with rainwater into watercourse.	Not allowed
5:1 (20%) or less	150 feet or more	Allowed using good judgment
2:1 (50%) or less	300 feet or more	Allowed using good judgment
Greater than 5:1 (50%)	Vegetated slope long distance from watercourse	Allowed
Greater than 5:1 (50%)	Sparsely vegetated slope and it appears that sediment will travel with rain into watercourse	Not allowed

- 8) Temporarily stockpile excavated soil away from streams, watercourses, or areas where run off will concentrate, until reuse or removal to a permanent disposal site. Implement erosion control BMPs on and around stockpiles to keep materials from eroding as outlined in Chapter 7.2- *Spoils Handling and Disposal*.
- 9) Use erosion control BMPs from the list below to repair and stabilize the slide area and the area disturbed during the repair. Use of biotechnical BMPs and native vegetation is preferable over hardscape techniques when appropriate for the site conditions. See Chapter 7.1 - *Erosion Control* for additional guidance about selection and implementation of appropriate BMPs, and consult with county engineering or planning as needed.
- 10) For biotechnical BMPs that require the establishment of vegetative cover, plan and implement ongoing vegetation maintenance and irrigation as needed.



- 11) After completion of construction, monitor the performance of long-term BMPs periodically, particularly after significant storm events. Perform immediate repairs or upgrades as necessary.

BMP TOOLBOX

Erosion Control BMPs

- ✓ Blankets/Geotextile Fabrics
- ✓ Coir Log/Roll
- ✓ Broadcast Seeding
- ✓ Hydroseeding
- ✓ Mulching
- ✓ Planting
- ✓ Surface Roughening & Soil Tracking
- ✓ Stepped or Terraced Slope
- ✓ Plastic Covering
- ✓ Rock Breast Wall
- ✓ Vegetated Geoberm Toe Wall

Sediment Control BMPs

- ✓ Brush Packing
- ✓ Sandbag
- ✓ Silt Mat Inlet
- ✓ Silt Mat/Vegetated Grassy Swale
- ✓ Silt Fence
- ✓ Sedimentation Trap/Sump
- ✓ Siltation Pond
- ✓ Storm Drain Inlet Protection
- ✓ Sweeping
- ✓ Turbidity Curtain
- ✓ Asphalt Berm
- ✓ Diversion Berm
- ✓ Energy Dissipater

Streambank Protection - Biotechnical BMPs

- ✓ Brush Mattress
- ✓ Joint Planting
- ✓ Large Woody Debris
- ✓ Live Fascine
- ✓ Live Stakes
- ✓ Fabric Reinforced Earth Fill with Brush Layering

Streambank Protection - Hardscape BMPs

- ✓ Boulder/Riprap
- ✓ Streambed Gravel



Water Management BMPs

- ✓ Diversion Berm
- ✓ Sandbag
- ✓ Slope Drain – Temporary
- ✓ Slope Drain – Overside
- ✓ Stream Bypass (Water Diversion)

PERMITS

7.2 MINOR SLIDE REPAIR	
Activity or Condition	Required permit or limitation
<ul style="list-style-type: none">• Instream work	<ul style="list-style-type: none">• See <i>Chapter 6.1 Working In and Or Near Stream Channels</i>
<ul style="list-style-type: none">• Bank stabilization	<ul style="list-style-type: none">• See <i>Chapter 6.4 Streambank Stabilization</i>





7.3 SPOILS HANDLING AND DISPOSAL

DESCRIPTION

Excess soil, sediment and debris are generated by a variety of county maintenance activities and must be handled and disposed of appropriately to keep these materials from eroding into streams and watercourses and impacting water quality. Activities generating these materials include excavation; grading; culvert cleaning; ditching, slide removal; drainage system maintenance; pavement removal; concrete work, and other activities. Site selection and stockpile maintenance guidelines for handling and disposal of these materials are provided below.

Note: The following standards are for non-hazardous materials. For handling of wastes or hazardous materials see *Chapter 9.4 - Waste Handling, Storage and Disposal* and *Chapter 9.5 - Hazardous Materials*.

ENVIRONMENTAL CONCERNS

- ✓ Discharge of sediment, debris, concrete, asphalt or organic material to streams or watercourses.
- ✓ Surface or groundwater impacts from leachate formed in organic material disposal sites.
- ✓ Destruction or harm to aquatic, riparian or wetland habitat, or to endangered or threatened plant and animal species due to placement of fill material.
- ✓ Catastrophic fill or slope failure due to improper placement of material.

BMP OBJECTIVES

- ✓ Protect water quality, aquatic habitat and riparian habitat by reducing erosion and sedimentation.
- ✓ Protect water quality by placing material that could generate leachate into properly permitted disposal facilities.
- ✓ Minimize impact to habitat and threatened or endangered species by selecting appropriate short term storage and disposal locations for spoils.

BEST MANAGEMENT PRACTICES

- 1) Identify and map existing permanent disposal sites that can be used for long-term disposal of materials from routine and emergency maintenance activities and provide this information to maintenance crews. These sites should be in upland areas, such as rock pits, ridges, and benches. Locations should be above the 100-year floodplain of the closest stream and away from any groundwater seeps or wetlands.



- 2) Temporary spoils stockpiles should be located in areas that are relatively level; relatively free of vegetation and outside the riparian zone; and away from streams, watercourses, wetlands, or areas where run off will concentrate. Do not place temporary spoils piles at the top of unstable slopes or at the edges of slopes. Remove temporary stockpiles to permanent disposal locations before the rainy season, or if work is conducted during the rainy season, as soon as feasible and before the next rain storm. Implement Erosion Control BMPs as referenced below on and/or around temporary spoil stockpiles to keep materials from eroding.
- 3) The performance of erosion control BMPs should be monitored routinely during construction, especially during and after storm events. BMPs should be maintained or upgraded as needed. Any materials not used at the site should be removed to a permanent disposal site at the conclusion of the construction project.
- 4) Reuse materials from spoils piles as much as possible. For example, clean soil may be used as fill for other projects.
- 5) Segregate and reuse or remove for recycling asphalt materials, concrete, and other construction waste, when feasible. These materials may be reused as fill for projects when they are placed in upland areas where they will not enter the stream system.
- 6) For permanent disposal sites, develop a long-term erosion and sediment control plan incorporating the use of Erosion Control and Sediment Management BMPs and a monitoring program to verify the effectiveness and long term integrity of the BMPs.
- 7) Avoid sidecasting of soil in all cases where it could be delivered into a watercourse, riparian area, roadside ditch or storm drain. Do not sidecast outside of the County right-of-way, without landowner's permission. In some instances, under the following guidelines (See Table below), sidecasting is allowable given remote distances from spoils storage sites. In these cases, the setback distance required depends on slope and vegetation. The presence of vegetation helps to slow the travel of sediment downslope, so good judgment is needed to assess the situation. *Do not sidecast at all* if the slope is sparsely vegetated and it appears that sediment will travel with rain runoff into a stream or estuary system, even if setback distances are applied. On slopes of 5:1 (20% gradient) or less, sidecasting is allowed beyond 150 feet of a watercourse, stream crossing, riparian area, roadside ditch or storm drain. On 2:1 slopes (50%) or less, sidecasting is allowed beyond 300 feet of a watercourse, stream crossing, riparian area, roadside ditch or storm drain. On slopes greater than 2:1, typically sidecasting is *not allowed at all*, however there may be rare instances on slopes greater than 2:1 where sidecasting is acceptable given very long distances from waterbodies and good vegetative cover. Seek advice from local fisheries agency staff when in doubt. Avoid concentrating sidecasting repeatedly in the same place. Never sidecast large amounts of soil from major landslides.



SLOPE GRADIENT	DISTANCE FROM WATERCOURSE, STREAM CROSSING, RIPARIAN AREA, ROADSIDE DITCH, STORM DRAIN	SIDECASTING RULE
Any slope	Appears that sediment will travel with rainwater into watercourse.	Not allowed
5:1 (20%) or less	150 feet or more	Allowed using good judgment
2:1 (50%) or less	300 feet or more	Allowed using good judgment
Greater than 5:1 (50%)	Vegetated slope long distance from watercourse	Allowed
Greater than 5:1 (50%)	Sparsely vegetated slope and it appears that sediment will travel with rain into watercourse	Not allowed

- 8) Except as provided in #5 below, do not leave loose soil piled in berms alongside the road or ditch. Loose or exposed soil berms are erodible and readily flushed into waterways and storm drains. Remove excess berm material before the rainy season. If placed in emergency during the rainy season, remove as soon as possible before the next rain. Dispose of all excess materials from shoulder maintenance activities in appropriate spoil disposal sites. (see Chapter 7.3-: Spoils Handling and Disposal).
- 9) Berms are used in some places for traffic delineation or public safety (i.e. line of sight along soft shoulders with steep drop-offs). If any berm is left in place it must be kept to a minimum height and be compacted and stabilized with seeding or asphalt. Use Erosion Control BMPs to stabilize berms that are being left in place for road delineation.
- 10) Frequent well placed breaks in the berms are necessary to allow water to drain from road and back into its original channel, preserving the natural drainage pattern of the slope. Check the areas breached to make sure they are stable. If erosion occurs at berm breaching areas, or the seeding is not in yet and rains are approaching, apply Erosion Control BMPs directly.
- 11) Dispose of concentrated amounts of vegetation that can generate leachate capable of affecting surface or groundwater quality only at permanent disposal sites that have Waste Discharge



Requirements (WDRs) for this purpose from the RWQCB, or for which WDRs have been waived.

- 12) Leave large woody debris in place if it does not increase the potential for flooding or damage to structures, create a public nuisance, create a fire hazard, or impact public safety. Large woody debris that is removed should be segregated and stored for future habitat improvement, when feasible.
- 13) Leave cut brush and branches remaining in riparian areas, adjacent to streams, when cut vegetation:
 - Does not cause a safety concern or fire hazard;
 - Does not contain noxious weeds (consult with appropriate staff about types and locations of noxious weeds);
 - Is not stockpiled in concentrated areas that can release leachate to surface water; and
 - Does not disturb existing drainage patterns.
- 14) When feasible, chip removed vegetation and reuse as mulch. Avoid mixing or burying organic materials in soil stockpiles as this limits the potential for future use.

BMP TOOLBOX

Erosion Control BMPs

- ✓ Blankets/Geotextile Fabrics
- ✓ Coir Log/Roll
- ✓ Mulching
- ✓ Planting
- ✓ Plastic Covering
- ✓ Seeding

Sediment Management BMPs

- ✓ Sand Bag
- ✓ Silt Fence
- ✓ Storm Drain Inlet Protection



PERMITS

7.3 SPOILS HANDLING AND DISPOSAL	
Activity or Condition	Required permit or limitation
<ul style="list-style-type: none"> Grading 	<ul style="list-style-type: none"> County grading ordinance County Noxious Weeds Ordinance Conditional Use Permit -County Planning Department Waste Discharge Requirements issued or waived by RWQCB
<ul style="list-style-type: none"> Disposing materials on United States Forest Service or Bureau of Land Management land 	<ul style="list-style-type: none"> Special use permits may be required
<ul style="list-style-type: none"> Coastal Zone 	<ul style="list-style-type: none"> Coastal development permit may be required
<ul style="list-style-type: none"> If spoils are placed above ordinary high water zone and away from wetlands. (See <i>Appendix B-Glossary</i>) 	<ul style="list-style-type: none"> Permits are not required from other State or Federal agencies

WARNING: Discharge of pollutants into streams from stockpiles can lead to fines from the Regional Water Quality Control Board or California Department of Fish and Game.





CHAPTER 8

VEGETATION MANAGEMENT

DESCRIPTION

Roadside vegetation is managed to provide a safer roadway for the traveling public, maintain sight distance, remove hazard trees, manage non-native species and prevent or repair slides or slip-outs. Vegetation growth can be managed manually, mechanically, or chemically. Activities include: mowing; trimming; pruning; spraying, removal of brush; tree removal; chipping; and disposal of plant debris. Vegetation often needs to be planted after a maintenance project is complete (i.e. hydro-seeding after a culvert repair).

These guidelines apply to any vegetation management that is done for any reason, with the exception of instream channel maintenance. For the purposes of this manual, that is considered a flood control activity (not covered here). See Flood Control Facility Maintenance Manual developed by the Bay Area Stormwater Management Agencies Association (BASMAA, June 2000).

ENVIRONMENTAL CONCERNS

- ✓ Discharge of sediment, plant material, or herbicides to streams or watercourses.
- ✓ Harm to aquatic habitat, riparian areas or rare plant populations.
- ✓ Loss of trees as shade canopy and a future source of large woody debris in stream systems.
- ✓ Water pollution from equipment operations.
- ✓ Water pollution from leachate in vegetation disposal areas.
- ✓ Damage to vegetation beneficial to erosion control on slopes or sediment filtering.
- ✓ Introduction of exotic or invasive plant species or spreading of plant diseases.
- ✓ Increasing water temperature due to loss of shade from riparian zone.

BMP OBJECTIVES

- ✓ Reduce potential for water pollution from sediment delivery, herbicides or equipment operations.
- ✓ Encourage healthy and native vegetation growth to stabilize slopes, filter sediments entering streams or watercourses and provide healthy riparian and aquatic habitat, including shade over streams.



BEST MANAGEMENT PRACTICES

- 1) Riparian vegetation is defined as “the vegetation growing in or near the banks of a stream or other body of water on soils that exhibit some wetness characteristics during some portion of the growing season”. The riparian area, includes “stream channels, wetlands and those portions of floodplains and valley bottoms that support riparian vegetation”.¹ These zones are of utmost value in protecting water quality and salmonid habitat. Therefore, it is extremely important that crews do not perform vegetation management in riparian areas unless under permit or in serious emergency conditions.
- 2) Vegetation management activities should be addressed by and comply with local vegetation management plans if they exist . These may include county vegetation management plans and chemical vegetation management guidelines issued by the county agricultural commissioner.
- 3) Mechanical vegetation control and/or integrated pest management methods are preferable to chemical methods when feasible.
- 4) Vegetation management and planting design should be conducted in a way that promotes native over non-native vegetation.

Mowing

- 5) Identify and protect drains and inlets from plant materials that may clog the inlets or disturb drainage patterns (i.e. grass clippings, branches, cuttings).
- 6) Minimize disturbance of ground cover or grass on the shoulder, near ditches and outside of the road right-of-way. If the ground is bladed clean during mowing, the exposed soil will be vulnerable to erosion and could run-off into a creek. Vegetation can also act as a pollution filter that traps sediment and other runoff before it gets into ditches or streams.
- 7) General guidelines for working within the road right-of-way:
 - Do not mow beyond 8 feet from the edge of the pavement unless that vegetation must be removed to retain existing drainage patterns or for safety reasons.
 - Do not remove brush more than 20 feet on either side of the road at bridge structures, unless additional removal is required to address safety concerns or to control noxious weeds.
 - Do not remove brush more than 10 feet on either side of a culvert, or 10 feet up and downstream from culverts that are 6-feet in diameter or larger, unless management is required for safety concerns or to control noxious weeds.

¹ Department of Fish and Game. (1998). California Salmonid Stream Habitat Restoration Manual.



- 8) County crews should receive specific training in vegetation management and proper cleaning of equipment to prevent passing contagious diseases to uninfected plant populations (e.g. Sudden Oak Death), and to prevent spreading seeds of invasive, non-native plant species.
- 9) When removing invasive plants and noxious weeds, use complete and thorough treatments. (Arundo is particularly difficult and requires at least two treatments to remove all underground root networks.)
- 10) Small quantities of cut brush and trees may be left in riparian areas, adjacent to streams, when cut vegetation:
 - Does not cause a safety concern or fire hazard;
 - Does not disturb existing drainage patterns.
 - Does not contain noxious weeds (consult with appropriate staff about types and locations of noxious weeds);
 - Is not stockpiled in concentrated areas that can release leachate to surface water;.
- 11) Dispose of larger amounts of vegetation and debris in approved upland disposal areas. Do not dispose of vegetation directly into waterbodies such as streams or wetlands. Do not permanently dispose of concentrated amounts of vegetation that can generate leachate that could affect surface or groundwater quality, unless disposal is at a location permitted for this purpose. (See *Chapter 7.3 Spoils Handling and Disposal*).
- 12) When feasible, chip removed vegetation and reuse as mulch.

Spraying

- 13) County crews using herbicides for vegetation management should receive specific training in their proper application, safe work practices and potential environmental hazards. Only personnel trained and certified in pesticide and herbicide use should be allowed to apply herbicides.
- 14) If using herbicides close to the “normal” start of the rainy season or in early springtime, use only aquatic approved formulations (e.g. Rodeo/Aquamaster with Agridex or LI-700 surfactant, not Round-Up). Timing, rate and volume of spraying should be included in a schedule for herbicide treatment. When in doubt, contact your County Agricultural Commissioner’s office.
- 15) A Federal Court ruling (2004) prohibits the application of 38 listed pesticides/herbicides within 20 feet of salmon bearing streams, lagoons or estuaries (manual application) and within 100 ft (aerial spray). Crews should be aware if their county uses these chemicals in vegetation management and be knowledgeable as to which streams have salmon in them. Your Agricultural Commissioner’s Office can give you advice on these rules and the use of these products.



Because of EPA's reviews and effects determinations on many of the 55 pesticides in question, the Court's Order effectively applies only to the following 38 pesticides. (February 2004 Federal Register)

1. 1,3-Dichloropropene	20. Fenbutatin-oxide
2. 2,4-D	21. Lindane (gamma-BHC and HCH)
3. Acephate	22. Linuron
4. Azinphos-methyl	23. Malathion
5. Bensulide	24. Methamidophos
6. Bromoxynil	25. Methidathion
7. Captan	26. Methomyl
8. Carbaryl	27. Methyl parathion
9. Carbofuran	28. Metolachlor
10. Chlorothalonil	29. Metribuzin
11. Chlorpyrifos	30. Naled
12. Coumaphos	31. Oxyfluorfen
13. Diazinon	32. Pendimethalin
14. Diflubenzuron	33. Phorate
15. Dimethoate	34. Prometryn
16. Disulfoton	35. Propargite
17. Diuron	36. Tebuthiuron
18. Ethoprop	37. Triclopyr BEE
19. Fenamiphos	38. Trifluralin

BMP TOOLBOX

Planning and Prevention BMPs

- ✓ Seasonal Planning
- ✓ Small Spill Kit

Erosion Control BMPs

- ✓ Mulching
- ✓ Planting

Sediment Control BMPs

- ✓ Storm Drain Inlet Protection

Valuable References

- ✓ County Vegetation Management Plan (if available)
- ✓ County Weed Management Areas (if available)
- ✓ County Integrated Pest Management Plan (if available)



PERMITS

CHAPTER 8- VEGETATION MANAGEMENT	
Activity or Condition	Required permit or limitation
<ul style="list-style-type: none"> Vegetation disposal sites that could impact surface or groundwater quality. 	<ul style="list-style-type: none"> Waste Discharge Requirements from the California Regional Water Quality Control Board
<ul style="list-style-type: none"> Application of herbicides or pesticides. 	<ul style="list-style-type: none"> Compliance with herbicide and pesticide restrictions and guidelines for application published by the County Agricultural Commissioner's office.
<ul style="list-style-type: none"> Removal of scenic resources, which may include large stands of trees; or healthy, mature, scenic trees. 	<ul style="list-style-type: none"> Comply with County Tree Ordinance or County Vegetation Management Plan; possible CEQA
<ul style="list-style-type: none"> Working within the riparian zone. 	<ul style="list-style-type: none"> DFG 1602 agreement may be needed
<ul style="list-style-type: none"> In Coastal Zone, Vegetation maintenance, including trimming and cutting by hand and mechanical means. 	<ul style="list-style-type: none"> Is exempt from a coastal development permit for maintenance treatment of all vegetative material growing native within the highway rights-of-way.
<ul style="list-style-type: none"> Removal of trees along designated <i>State Wild & Scenic Rivers</i> may require further permitting 	<ul style="list-style-type: none"> Check with the California Resources Agency Department of Conservation



CHAPTER 9
MAINTENANCE FACILITIES

9.1 Building and Grounds Maintenance.....9-3

9.2 Vehicle and Equipment Maintenance.....9-7

9.3 Oil/Water Separator Maintenance..... 9-11

9.4 Waste Handling, Storage and Disposal..... 9-13

9.5 Storage of Hazardous Materials..... 9-15

9.6 Spill Prevention and Control..... 9-19





9.1 BUILDING AND GROUNDS MAINTENANCE

DESCRIPTION

Permanent maintenance facilities require building and grounds maintenance, including care of landscaped areas around the facility; cleaning of parking areas and driveways; and maintenance of the storm water drainage system. Proper handling and disposal of waste and wash water generated during building and grounds maintenance; minimization of water use, and immediate clean up of spills are key elements in the protection of storm water quality.

ENVIRONMENTAL CONCERNS

- ✓ Discharge of the following materials into the storm water drainage system or watercourses:
 - Litter and debris
 - Plant material
 - Fertilizer
 - Pesticides
 - Herbicides
 - Sediments
 - Petroleum products

BMP OBJECTIVES

- ✓ Minimize the likelihood of water pollution.

BEST MANAGEMENT PRACTICES

- 1) Most county maintenance yards conduct activities subject to the General Industrial Storm Water Discharge NPDES Permit. These facilities must notify the RWQCB and prepare and implement a Storm Water Pollution Prevention Plan (SWPPP) and a Storm Water Monitoring Program (SWMP). Facilities with above-ground petroleum product storage exceeding planning thresholds (see Permits section below) must also prepare and implement a Spill Prevention, Control and Countermeasures (SPCC) Plan, and facilities that handle more than 55 gallons of hazardous materials must prepare and implement a Hazardous Materials Business Plan (HMBP) and file it with the local Certified Unified Program Agency (CUPA). These plans require periodic evaluations and updates. County maintenance personnel should be familiar with and implement the provisions of these plans at their yard facilities.
- 2) Perform annual employee education about storm water management, procedures for emergency response, proper handling of hazardous materials, and spill cleanup.



- 3) Periodically inspect, clean, and maintain the storm water drainage system. At a minimum, the system should be checked in the fall, prior to the rainy season, and in conjunction with scheduled visual inspections performed as part of the SWMP.
- 4) Properly label all containers.
- 5) Cover all dumpsters during rainy season; inspect for fluids leaking from dumpsters and patch holes if leaks are identified.
- 6) Sweep or vacuum maintenance facility floors and pavement to prevent tracking of materials outdoors. Use mopping as an alternative to hosing down work areas when possible.
- 7) When mopping is used to clean maintenance area floors or pavement, do not dispose of mop water into the parking lot, street, gutters, or drain inlets. Contain and dispose of the mop water to the sanitary sewer system following these guidelines:
 - Remove any spilled oil or other hazardous liquid using dry sweep or rags to absorb the spill before mopping.
 - If an oil/water separator is available, pour the mop water into a separator inlet so that the wastewater is treated before being discharged to the sanitary sewer system.
 - If a sanitary sewer connection is not available, provide dead-end sump or storage tank to collect mopping wash water. Periodically clean out sump or tank and haul to sewer system. Do not dispose hazardous liquids into the sump or tank.
- 8) Use drip pans or absorbent material under leaking vehicles and equipment to capture fluids. Recycle or dispose of fluids and absorbent materials as appropriate.
- 9) Recycle or properly dispose of used oil, antifreeze, solvents, asphaltic emulsion, and any other hazardous or toxic materials.
- 10) Use street sweeper frequently at the motor pool.
- 11) Monitor runoff from the area to determine BMP performance. Determine if a swirl separator type device with an oil-water separator feature is needed.
- 12) Install a grassy swale where runoff leaves the motor pool if sufficient space is available.
- 13) Properly dispose of used rags, contaminated materials, and sweeping and cleaning wastes as solid waste.
- 14) Minimize water use when washing equipment and vehicles.



- 15) For facilities with sanitary/industrial sewer connections, drain or dispose of wash water to the oil water separator (if available) or to the sewer if acceptable under the facilities discharge permit. Under no circumstances discharge wash water to storm drains, the site surface or to sewers connected to a septic system.

- 16) Avoid excessive irrigation of landscaped areas. Program the amount and timing of automatic controllers to minimize runoff and encourage deep rooting of vegetation.

- 17) When flushing water lines, reuse the rinse water for landscaping purposes as long as excess water does not negatively impact any receiving waters or cause erosion. Avoid large volumes of water running off the site into storm drains or watercourses.

- 18) Apply fertilizer and pesticides in accordance with the label instructions and county regulations and guidelines. Use of integrated pest management is always preferable where applicable.

- 19) Use the least toxic housekeeping products that can effectively do the job.

BMP TOOL BOX

Planning and Prevention BMPs

- ✓ Hazardous Materials Site Planning
- ✓ Small Spill Kit
- ✓ Large Spill Kit

PERMITS

9.1 BUILDING AND GROUNDS MAINTENANCE	
Activity or Condition	Required permit or limitation
<ul style="list-style-type: none"> • Total above-ground petroleum product storage at the facility exceeds 1,320 gallons in aggregate or 660 gallons in any individual container, or underground petroleum product storage exceeds 42,000 gallons. 	<ul style="list-style-type: none"> • Prepare and comply with a Spill Prevention, Control and Countermeasures Plan
<ul style="list-style-type: none"> • County maintenance facilities 	<ul style="list-style-type: none"> • Must apply with the RWQCB to be covered under the General Industrial Storm Water Discharge Permit, and prepare and implement a Storm Water Pollution Prevention Plan and a Storm Water Monitoring Program
<ul style="list-style-type: none"> • County maintenance facilities 	<ul style="list-style-type: none"> • Must file a Hazardous Materials Business Plan



9.1 BUILDING AND GROUNDS MAINTENANCE

Activity or Condition	Required permit or limitation
handling 55 gallons or more of hazardous materials	with their Certified Unified Program Agency (CUPA).
<ul style="list-style-type: none">• Hazardous material (e.g., fuel or waste oil) underground storage tanks	<ul style="list-style-type: none">• Register with the CUPA and comply with storage tank construction and leak detection monitoring regulations of the SWRCB
<ul style="list-style-type: none">• Above-ground hazardous material storage tanks	<ul style="list-style-type: none">• File an inventory statement for any with the SWRCB
<ul style="list-style-type: none">• Vehicle fueling systems	<ul style="list-style-type: none">• Permits to construct and permits to operate must be obtained from the local Air Quality Management District for. Compliance requirements vary by jurisdiction
<ul style="list-style-type: none">• Discharges of vehicle or equipment wash water to the sewer system	<ul style="list-style-type: none">• Industrial waste water discharge permits are typically required from the local sewage treatment facility. Compliance requirements may include pollutant discharge limits, discharge volume restrictions and discharge volume and pollutant monitoring and reporting.



9.2 VEHICLE AND EQUIPMENT MAINTENANCE

DESCRIPTION

Vehicles and equipment are stored and maintained at county maintenance yards. Maintenance activities performed at the yard include fueling, cleaning, painting, maintenance and repair of vehicles and equipment.

ENVIRONMENTAL CONCERNS

- ✓ Discharge of the following materials into the storm water drainage system or watercourses:
 - Automotive vehicle fluids, including fuel, ATF, oil and antifreeze
 - Automobile maintenance chemicals such as solvents and carburetor cleaner
 - Cleaning products
 - Sediment
 - Paint products
- ✓ Soil or groundwater contamination.

BMP OBJECTIVES

- ✓ Reduce the likelihood of water pollution.
- ✓ Protect aquatic species.

BEST MANAGEMENT PRACTICES

- 1) Employees should be trained in and familiar with provisions of the Storm Water Pollution Prevention Plan, Hazardous Materials Business Plan, Hazard Communications Program and (if planning thresholds are exceeded) the Spill Prevention, Control and Countermeasures Plan for the facility. Training should include procedures for emergency response, proper handling of hazardous materials, and spill cleanup. Update the plans for the facility at the required intervals.
- 2) Keep an ample supply of spill clean-up materials near fueling, vehicle maintenance and hazardous materials/hazardous waste storage areas. Inventory clean-up materials monthly and restock as needed. Restock immediately following significant spills.
- 3) Post proper fueling and spill clean-up instructions at fueling areas. Never leave the area while equipment is being fueled.



- 4) If a spill does occur, contain and clean up the spill immediately using dry absorbent (e.g., “clean sweep”), absorbent pads and/or absorbent pillows. Handle and dispose of used spill pillows and other absorbents as hazardous waste.
- 5) Use a “dry shop” principle for cleaning areas used for maintenance, materials storage and fueling. Use absorbents such as “clean sweep,” pads or pillows to clean up free liquids; a damp cloth for wiping fuel dispensers and other equipment; and a damp mop on the floor for final cleaning.
- 6) Install automatic shut off (“break away”) valves at each fueling pump, and manual shut off valves inside and outside of shop buildings.
- 7) Pave the ground where fueling takes place with concrete or chip seal.
- 8) Periodically inspect hazardous materials and hazardous waste storage areas, maintenance areas, above ground tanks and fuel dispensers for leaks.
- 9) Perform vehicle and equipment maintenance in a designated covered facility, where feasible.
- 10) For vehicle fluid removal, transfer contents to designated vehicle waste fluid storage drums or tanks. Use drip pans under vehicles when draining or filling fluids.
- 11) When cleaning engines or parts:
 - If using solvents to clean parts, perform the work in self-contained solvent sinks or tanks.
 - After cleaning, allow parts to drain over the solvent sink or tank. Prevent dripping of solvent, onto the floor.
 - Allow parts to dry over the hot tank, if available. If rinsing is required, rinse over the hot tank.
 - Steam clean or pressure wash parts only over containments designed for this purpose.
- 12) Perform vehicle and mobile equipment steam cleaning, pressure washing or degreasing only over a containment designed to collect any generated wash water. Collect wash water and discharge to sewer via an oil water separator as discussed in *MY01 Building and Grounds Maintenance*. Do not pour wash water down storm drains or sewers connected to septic systems.
- 13) Perform vehicle washing in a building or structure designed for this purpose. Use a closed-loop system to recycle wash water or discharge wash water to the sewer. Washing areas without a closed loop system or a connection to the sewer should be designed to



contain wash water for later removal. Wash water should not be allowed to run off onto adjacent areas or discharged to storm drains, soil or surface water.

14) Designate an area for pre-wash of vehicles and equipment to capture solid materials, where feasible. Wash water from this area should be handled as indicated above.

15) Vehicle washing areas should be equipped with sediment traps. Sediment traps should be inspected and cleaned periodically, and the sediment removed from the site for disposal at an appropriately licensed facility.

BMP TOOL BOX

Planning and Prevention BMPs

- ✓ Small Spill Kit
- ✓ Large Spill Kit\

PERMITS

9.2 VEHICLE AND EQUIPMENT MAINTENANCE	
Activity or Condition	Required permit or limitation
<ul style="list-style-type: none"> • Total above-ground petroleum product storage at the facility exceeds 1,320 gallons in aggregate or 660 gallons in any individual container, or underground petroleum product storage exceeds 42,000 gallons. 	<ul style="list-style-type: none"> • Prepare and comply with a Spill Prevention, Control and Countermeasures Plan
<ul style="list-style-type: none"> • County maintenance facilities 	<ul style="list-style-type: none"> • Must apply with the RWQCB to be covered under the General Industrial Storm Water Discharge Permit, and prepare and implement a Storm Water Pollution Prevention Plan and a Storm Water Monitoring Program
<ul style="list-style-type: none"> • County maintenance facilities handling 55 gallons or more of hazardous materials 	<ul style="list-style-type: none"> • Must file a Hazardous Materials Business Plan with their Certified Unified Program Agency (CUPA).
<ul style="list-style-type: none"> • Hazardous material (e.g., fuel or waste oil) underground storage tanks 	<ul style="list-style-type: none"> • Register with the CUPA and comply with storage tank construction and leak detection monitoring regulations of the SWRCB
<ul style="list-style-type: none"> • Above-ground hazardous material storage tanks 	<ul style="list-style-type: none"> • File an inventory statement for any with the SWRCB
<ul style="list-style-type: none"> • Vehicle fueling systems 	<ul style="list-style-type: none"> • Permits to construct and permits to operate must be obtained from the local Air Quality Management District for. Compliance



9.2 VEHICLE AND EQUIPMENT MAINTENANCE

Activity or Condition	Required permit or limitation
	requirements vary by jurisdiction
<ul style="list-style-type: none">Discharges of vehicle or equipment wash water to the sewer system	<ul style="list-style-type: none">Industrial waste water discharge permits are typically required from the local sewage treatment facility. Compliance requirements may include pollutant discharge limits, discharge volume restrictions and discharge volume and pollutant monitoring and reporting.Compliance requirements may include pollutant discharge limits, discharge volume restrictions and discharge volume and pollutant monitoring and reporting.



9.3 OIL/WATER SEPARATOR MAINTENANCE

DESCRIPTION

Many maintenance facilities have portable or permanent oil water separators. Oil water separators are often used in vehicle and equipment washing areas or steam cleaning containments to separate oil and other products from the wash water before it drains to the sanitary sewer. Oil water separators may be used to similarly pre-treat mop water or other wash water before it drains to the sanitary sewer. Oil water separators must be maintained to be effective at separating oil and other products from wash water. (Refer to sanitation district pretreatment program regulations and permit requirements.)

ENVIRONMENTAL CONCERNS

- ✓ Discharge of oil, grease, or other hydrocarbons into the storm water drainage system, watercourses, or groundwater.
- ✓ Discharge of soluble oils and hydrocarbons into soil and groundwater via leach fields

BMP OBJECTIVES

- ✓ Reduce the likelihood of water pollution.

BEST MANAGEMENT PRACTICES

- 1) Water discharges from maintenance areas, steam cleaning or pressure washing containments and (as required in some jurisdictions) vehicle wash areas should be directed to an oil water separator prior to discharge to a sewer system. Discharge of water from these sources to a septic system is not permitted under any circumstances, even if an oil water separator has been installed.
- 2) Remove accumulated oil and grit frequently to maintain effective performance of the separator. Designate frequency of cleaning oil/water separators based on size and use of the facility.
- 3) Recycle oil or dispose of oil according to hazardous waste disposal standards (See *Chapter 9.5- Hazardous Materials*).
- 4) Dispose of grit from separator appropriately. If the grit is contaminated with oil or heavy metals it must be disposed at an appropriately permitted facility and handled according to applicable standards for those materials, and cannot simply be placed into the trash (See *See Chapter 9.5 Hazardous Materials*). Consult your supervisor for proper disposal procedures for each separator/facility.



- 5) Record maintenance dates of oil/water separators in order to track upkeep and to prolong the life of the device.
- 6) Do not discharge hazardous liquids such as oil and automotive fluids to the sewer system, even if an oil/water separator is in place.

BMP TOOL BOX

Planning and Prevention BMPs

- ✓ Hazardous Materials Site Planning
- ✓ Small Spill Kit
- ✓ Large Spill Kit

PERMITS

9.3 OIL/WATER SEPERATOR MAINTENANCE	
Activity or Condition	Required permit or limitation
<ul style="list-style-type: none"> • Discharges from maintenance and steam cleaning containments, and is often also required for discharges from vehicle washing areas. 	<ul style="list-style-type: none"> • Industrial waste water discharge permit from the local sewage treatment facility. Use of oil water separators is typically required under these permits Contact your local sewage treatment facility for additional information.
	<ul style="list-style-type: none"> • Comply with the Storm Water Pollution Prevention Plan for the facility.



9.4 WASTE HANDLING, STORAGE, AND DISPOSAL

DESCRIPTION

Some wastes generated by maintenance activities are stored at the maintenance yard prior to disposal. Care must be taken when handling these materials and standards must be followed to assure these materials are properly stored and disposed. Hazardous wastes have stricter storage and documentation requirements and are discussed in *MY05 – Storage of Hazardous Materials*). We cannot stress enough the economic and environmental benefits of preventing spills of toxic materials.

WARNING: Always consult your supervisor if you are unclear of the proper procedures, containers, or storage locations for the type of waste you are handling.

ENVIRONMENTAL CONCERNS

- ✓ Discharge of the following materials into the storm water drainage system or watercourses:
 - waste products;
 - litter and debris;
 - sediment;
 - waste fluids from auto maintenance;
 - oil water separator grits; or
 - other organic or inorganic waste material.

BMP OBJECTIVES

- ✓ Prevent pollutants from entering drainage systems or watercourses at or near the facility.
- ✓ Prevent ground water or soil contamination at or near the facility.
- ✓ Prevent soil, surface water and groundwater contamination through disposal of waste materials at appropriate off-site facilities.
- ✓ Use proper secondary containment for wastes.

BEST MANAGEMENT PRACTICES

- 1) Maintain an inventory of the types of waste streams handled at the facility, containers used for storage, facilities designated for off-site disposal, and any special handling or storage requirements.
- 2) Minimize the amount of waste that is generated to the extent possible. Conduct an inventory of supplies and order in smaller quantities as appropriate to reduce the amount of excess and unused materials stored on site.



- 3) Use the least toxic products available that will do the job.
- 4) Reuse or recycle materials when feasible. Segregate materials designated for recycling.
- 5) Place waste into appropriate containers. For example, put liquid or flammable waste in drums or tanks designed to contain such materials. Place oily rags into metal waste cans designed for storage of flammable rags.
- 6) Close waste containers when waste is not being actively added or removed.
- 7) Set up a routine inspection schedule to check for leaking or deteriorated containers and repair or replace as appropriate. At a minimum, conduct inspections as part of the facility's Storm Water Monitoring Program. Inspections should be more frequent during the rainy season.
- 8) Use extra caution when handling wastes outside during rainfall events. If possible, postpone activities that could lead to spills of waste due to weather.
- 9) Ensure that all wastes such as residual paints, batteries, spent fuels, chemicals, and other wastes that can cause pollution are stored in properly designed and constructed secondary containment and are protected from the rain.
- 10) Materials should be stored on paved surfaces. The pad should be able to capture or contain possible spills through the use of an underground container to capture spilled materials or sufficiently sized curbing to hold the spill on the pavement.

BMP TOOLBOX

Planning and Prevention BMPs

- ✓ Hazardous Materials Site Planning
- ✓ Small Spill Kit
- ✓ Large Spill Kit

PERMITS

9.4 WASTE HANDLING, STORAGE AND DISPOSAL	
Activity or Condition	Required permit or limitation
	<ul style="list-style-type: none"> • Comply with the Storm Water Pollution Prevention Plan for the site.



9.5 STORAGE OF HAZARDOUS MATERIALS

DESCRIPTION

Maintenance facilities may store a variety of materials that are classified as Hazardous Material or Hazardous Waste based on flammability, toxicity or corrosivity. These products may be harmful to the environment if they come in contact with surface waters or soil.

WARNING: Always consult your supervisor if you are unclear of the proper handling procedures, containers, or storage locations for the type of material or waste you are handling.

DANGER: Notify the State Office of Emergency Services (OES) at 800-852-7550 when a hazardous material spill occurs.

ENVIRONMENTAL CONCERNS

- ✓ Discharge of the following materials into the storm water drainage system or watercourses:
 - Automotive vehicle fluids, including fuel, ATF, oil and antifreeze
 - Automobile maintenance chemicals such as solvents and carburetor cleaner
 - Cleaning products
 - Sediment
 - Paint products
 - Corrosives
 - Pesticides, fertilizers and herbicides.
- ✓ Soil or groundwater contamination.
- ✓ Fire and related air and surface water discharges.
- ✓ Harm to aquatic life or other wildlife.
- ✓ Harm to human health and safety.

BMP OBJECTIVES

- ✓ Protect groundwater quality and potential beneficial uses.
- ✓ Prevent pollutants from entering drainage systems or watercourses.

BEST MANAGEMENT PRACTICES

- 1) Employees should be trained in and familiar with provisions of the Storm Water Pollution Prevention Plan, Hazardous Materials Business Plan (including Emergency Response and Contingency Plan if the facility generates hazardous waste), Hazard Communications Program and (if planning thresholds are exceeded) the Spill Prevention, Control and Countermeasures Plan for the facility. Training should include procedures for emergency response, proper handling of hazardous materials, selection and use of



personal protective equipment and spill cleanup. Update the plans for the facility at the required intervals.

2) For Hazardous Materials Storage (General):

- Train personnel on proper handling procedures and familiarize them with the procedures in the emergency response portion of the above plans. Post proper handling instructions and Material Safety Data Sheets in a conspicuous location.
- Limit access to storage areas to authorized persons only.
- Keep labels on containers and ensure that covers or caps are secure when containers are not in use.
- Maintain an ample inventory of appropriate spill clean-up materials near all storage areas and attend to all spills immediately. Keep absorbent and baking soda on hand to soak up spilled fluids and to neutralize spilled acid from cracked batteries. Use appropriate personal protective equipment (e.g., rubber boots, gloves and safety glasses).
- Maintain fire extinguishers near hazardous materials and waste storage areas.
- Mark storage areas with the appropriate NFPA placards.
- Store materials on paved surfaces, minimize moving stored materials, and periodically inspect storage facilities.
- Store hazardous materials in a designated area containing similar and chemically compatible materials. Do not store incompatible products in the same storage area without some type of physical barrier separating the containers. For example, do not store oxidizers, such as hydrogen peroxide, with organics or flammable materials such as oil.
- Store small (consumer) containers of flammable materials in flammable materials storage cabinets when not in use.
- Store hazardous materials under cover and away from areas that might drain into the storm water drainage system or watercourses. Store granular hazardous materials under cover well away from waterways, storm drains, curbs, and gutters.
- Store hazardous liquid materials; including lead acid batteries, in secondary containment (Uniform Fire Code Article 80, Section 8003.1.3.3).
- Install safeguards to prevent accidental releases such as: overflow protection devices; automatic shutdown interlocks on transfer pumps; and traffic protection guards (bollards) around tanks and piping to prevent vehicle or forklift damage.

3) For Outdoor Container Storage Areas:

- Inspect storage areas weekly and before and after rainfall events. Ensure all containers are properly labeled, covered, securely fastened and in good condition. Check for external corrosion or other signs of wear of material containers (CCR Title 22 Section 66265.174).
- If a container is corroded or leaking, have trained and qualified personnel or the local Hazmat Manager transfer wastes to a new clean container. Label the new container appropriately and properly clean (if equipped to do so) and dispose of



the old container. Note that the old container may be classified as hazardous waste if not cleaned.

- Repair and/or replace perimeter controls, containment structures, and covers as necessary to ensure their proper functioning.
- Cover treated wood post storage areas during the rainy season.

4) For Paint Storage Area:

- Inspect all pallets of paint to ensure that they are securely fastened before moving.
- Load and off-load paint on level ground when using a forklift to minimize possible spills and ruptures of paint containers.
- Where feasible, store paint materials in an area with a canopy or roof designed to direct runoff away from the area. Paint is hazardous to aquatic systems.

5) When storing and disposing hazardous wastes:

- Hazardous waste should be handled and managed only by personnel trained to do so.
- Place appropriate placards on all hazardous waste storage and satellite accumulation areas.
- Hazardous waste storage areas should be locked and only authorized personnel with hazardous waste training should be allowed to enter.
- Inspect hazardous waste storage areas weekly and maintain a record of inspections.
- Store all hazardous waste in secondary containment.
- Place hazardous waste in appropriate containers. Containers must be DOT-approved if used for off site shipment. Do not store liquid waste materials in buckets.
- Place hazardous waste labels on all hazardous waste containers as soon as they are used. Label empty containers as empty.
- Containers should be kept closed unless they are actively being filled or emptied.
- Dispose of hazardous waste only at authorized treatment, storage and disposal facilities. Illegal dumping of hazardous waste is a violation subject to fine and/or time in jail under several state and federal regulations.
- Use licensed hazardous waste haulers for threshold quantities as required by state and federal regulations.
- Cover containers carrying hazardous materials during transit. Illegal transit of hazardous waste is a violation subject to fine and/or jail time.

BMP TOOL BOX

Planning and Prevention BMPs

- ✓ Hazardous Materials Site Planning
- ✓ Small Spill Kit
- ✓ Large Spill Kit



PERMITS

9.5 STORAGE OF HAZARDOUS MATERIALS	
Activity or Condition	Required permit or limitation
<ul style="list-style-type: none"> Total above-ground petroleum product storage at the facility exceeds 1,320 gallons 	<ul style="list-style-type: none"> Prepare and comply with a Spill Prevention, Control and Countermeasures Plan
<ul style="list-style-type: none"> County maintenance facilities 	<ul style="list-style-type: none"> Must apply with the RWQCB to be covered under the General Industrial Storm Water Discharge Permit, and prepare and implement a Storm Water Pollution Prevention Plan and a Storm Water Monitoring Program
<ul style="list-style-type: none"> County maintenance facilities handling 55 gallons or more of hazardous materials 	<ul style="list-style-type: none"> Must file a Hazardous Materials Business Plan with their Certified Unified Program Agency (CUPA).
<ul style="list-style-type: none"> Above-ground hazardous material storage tanks 	<ul style="list-style-type: none"> File an inventory statement for any with the SWRCB.
<ul style="list-style-type: none"> Hazardous material (e.g., fuel or waste oil) underground storage tanks 	<ul style="list-style-type: none"> Register with the CUPA and comply with storage tank construction and leak detection monitoring regulations of the SWRCB
<ul style="list-style-type: none"> Facilities generating hazardous waste 	<ul style="list-style-type: none"> Must obtain a Generator Identification Number from U.S. EPA or the California Department of Toxic Substances Control
<ul style="list-style-type: none"> Transport and disposal of contaminated material and hazardous waste 	<ul style="list-style-type: none"> Must be in accordance with the rules and regulations of the following agencies: <ul style="list-style-type: none"> U.S. Department. of Transportation (U.S. Environmental Protection Agency California Environmental Protection Agency (CAL-EPA). California Department of Toxic Substances Control (DTSC). California Division of Occupational Safety and Health Administration (CAL-OSHA). Local Regulatory Agencies (e.g., County Department of Public Health).



9.6 SPILL PREVENTION AND CONTROL

DESCRIPTION

Maintenance facilities may utilize above ground storage tanks for storage of bulk quantities of liquids. Often the liquids stored are potentially harmful to human health or the environment. Safeguards must be in place at the maintenance yard and spill prevention and control standards must be followed to prevent the discharge of potential pollutants to the storm water drainage system or watercourses from above ground storage tanks and accidental spills.

DANGER: If a large spill or rupture occurs: (1) call 911; (2) contact the Road Supervisor; and (3) contact the local Hazmat Manager. Your supervisor and Hazmat Manager will determine if a Hazmat team or private clean-up company is required. Notify the State Office of Emergency Services (OES) at 800-852-7550. See the Permits section below for additional agency notification requirements.

ENVIRONMENTAL CONCERNS

- ✓ Discharge of the following materials into the storm water drainage system or watercourses:
 - Automotive vehicle fluids, including fuel, ATF, oil and antifreeze
 - Automobile maintenance chemicals such as solvents and carburetor cleaner
 - Cleaning products
 - Sediment
 - Paint products
 - Corrosives
 - Pesticides, fertilizers and herbicides.
- ✓ Soil or groundwater contamination.
- ✓ Fire and related air and surface water discharges.
- ✓ Harm to aquatic life or other wildlife.
- ✓ Harm to human health and safety

BMP OBJECTIVES

- ✓ Protect groundwater quality and potential beneficial uses.
- ✓ Prevent pollutants from entering drainage systems or watercourses.

BEST MANAGEMENT PRACTICES

- 1) Prepare and comply with a Spill Prevention, Control and Countermeasures Plan if total above-ground petroleum product storage at the facility exceeds 1,320 gallons in



aggregate or 660 gallons in any individual container, or if underground petroleum product storage exceeds 42,000 gallons. Employees should be trained in and familiar with the provisions of this plan. Training should include procedures for emergency response, proper handling of hazardous materials, selection and use of personal protective equipment and spill cleanup. Evaluate the plan every two years and update as needed.

- 2) Employees should be trained in and familiar with the provisions of the Storm Water Pollution Prevention Plan, Hazardous Materials Business Plan and the Hazard Communications Program. Update these plans for the facility at the required intervals.
- 3) All above-ground hazardous materials storage tanks should be provided with secondary containment, protected from potential vehicle or mobile equipment impacts using bollards or similar devices and, if possible, placed under cover to protect them from rainfall.
- 4) If above-ground storage tanks are not sheltered and the secondary containment fills with rainwater, the rainwater must be inspected and may need to be tested prior to releasing it from the containment to make sure it does not contain contaminants. If the rainwater contains contaminants, it must be containerized pending discharge to the sewer system or off-site disposal at a licensed facility, as appropriate.
- 5) After releasing rainwater from secondary containment, ensure that drain valve is closed.
- 6) Inspect existing above ground storage tanks, secondary containment, and associated valves and piping for signs of leakage, external corrosion, structural failure, and loose connections at least monthly.
- 7) Keep a spill kit near above-ground storage tanks. Such a kit includes an ample supply of clean-up materials (absorbent materials, shovel, rags, and plastic bags). Inventory clean-up materials monthly and restock as needed. Restock immediately following significant spills.
- 8) Contain and clean-up small spills immediately.
 - Assess the type of material spilled and use appropriate personal protective equipment (e.g., rubber boots, gloves and safety glasses).
 - Block all storm drain inlets and contain the spill using spill “pigs” and absorbent pillows.
 - Soak up wet spills using an absorbent material or dry mop.
 - Place wastes and absorbents in a waste container and dispose of the contents according to approved waste disposal procedures (see *Chapter 9.4- Waste Handling, Storage, and Disposal*; and *Chapter 9.5- Hazardous Material Storage*).



BMP TOOLBOX

Planning and Prevention BMPs

- ✓ Hazardous Materials Site Planning
- ✓ Small Spill Kit
- ✓ Large Spill Kit

PERMITS

9.6 SPILL PREVENTION AND CONTROL	
Activity or Condition	Required Permit or Limitation
<ul style="list-style-type: none"> • Total above-ground petroleum product storage at the facility exceeds 1,320 gallons in aggregate or 660 gallons in any individual container, or if underground petroleum product storage exceeds 42,000 gallons. 	<ul style="list-style-type: none"> • Prepare and comply with a Spill Prevention, Control and Countermeasures Plan
<ul style="list-style-type: none"> • County maintenance facilities 	<ul style="list-style-type: none"> • Must apply with the RWQCB to be covered under the General Industrial Storm Water Discharge Permit, and prepare and implement a Storm Water Pollution Prevention Plan and a Storm Water Monitoring Program
<ul style="list-style-type: none"> • County maintenance facilities handling 55 gallons or more of hazardous materials 	<ul style="list-style-type: none"> • Must file a Hazardous Materials Business Plan with their Certified Unified Program Agency (CUPA).
<ul style="list-style-type: none"> • Hazardous material (e.g., fuel or waste oil) underground storage tanks 	<ul style="list-style-type: none"> • Register with the CUPA and comply with storage tank construction and leak detection monitoring regulations of the SWRCB
<ul style="list-style-type: none"> • Above-ground hazardous material storage tanks 	<ul style="list-style-type: none"> • File an inventory statement with the SWRCB.
<ul style="list-style-type: none"> • In the case of a hazardous spill 	<ul style="list-style-type: none"> ◆ Ensure the following agencies are contacted related to the listed conditions: <ul style="list-style-type: none"> ○ County Sheriff – for dispatch and if substance is off-highway in unincorporated area. ○ County Division of Environmental Health – for all incidents. ○ CDF&G – if substance is in or near a waterway or affects wildlife. ○ RWQCB – if substance is in or near a waterway (County Environmental Health is responsible for notifying) ○ Local Hazardous Material Response Team (HMRT) – in the event of a spill

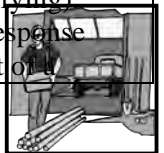

9.6 SPILL PREVENTION AND CONTROL

Activity or Condition	Required Permit or Limitation
	<p>significant hazardous material incident, Level II or greater, the HMRT shall be requested immediately by on-scene personnel.</p> <ul style="list-style-type: none"> ○ State Office of Emergency Services Warning Center – for all incidents – (800) 852-7550. ○ California Highway Patrol – if substance is on a road way or State Highway. ○ Coast Guard Marine Safety Office – if spill is near coast, offshore, or in a bay. ○ US EPA, if substance is in other than navigable waters and response is beyond capabilities of local and state resources – (800) 424-8802 National Response Center. ○ Landowners where spill occurred if adjacent to county road



CHAPTER 10
EMERGENCY WORK

10.1 Emergency Response..... 10-3

10.2 Emergency Slide and Washout Repair..... 10-10

10.3 Accident Clean Up..... 10-15

10.4 Emergency Utility Repairs 10-17





10.1 EMERGENCY RESPONSE

DESCRIPTION

County roads and maintenance crews must respond quickly to fix damage to roadways and structures caused by storms, floods, and other events. Typical emergency response activities include: storm damage patrol; debris removal; emergency opening or closing of a road; and repairs to roads, slopes, and drainage facilities. County roads crews need to plan for emergency response scenarios to *protect the public* and ensure that appropriate measures are employed to *protect the environment*.

Emergency is defined by our regulatory agencies as:

“A situation which would result in an unacceptable hazard to life, a significant loss of property, or an immediate, unforeseen, and significant economic hardship if corrective action requiring a permit is not undertaken within a time period less than the normal time needed to process the application under standard.” (COE Regulations);

“A situation involving an act of God, disasters, casualties, national defense or security emergencies, etc., and includes response activities that must be taken to prevent imminent loss of human life or property.” (ESA rules, 50 CFR 402.05); and

“A sudden, unexpected occurrence, involving a clear and imminent danger, demanding immediate action to prevent or mitigate loss of, or damage to, life, health, property or essential public services. Emergency includes such occurrences as fire, flood, earthquake, or other soil or geologic movements, as well as such occurrences as riot, accident, or sabotage.” (CEQA 15359).

ENVIRONMENTAL CONCERNS

- ✓ Discharge of sediment, organic material, and other potential pollutants to streams, watercourses, or storm water drainage systems.
- ✓ Alteration of stream channels or destruction of riparian or aquatic habitat.
- ✓ Creation of a barrier to fish passage.

BMP OBJECTIVES

- ✓ Prioritize maintenance for problematic areas to keep them from becoming an emergency.
- ✓ Reduce the amount of road-related and hillslope materials entering storm drain inlets and watercourses.
- ✓ Decrease or prevent sediment delivery to storm drains inlets and watercourses.
- ✓ Prevent the entry of spills into storm drains inlets and watercourses.



BEST MANAGEMENT PRACTICES

- 1) Temporarily store materials (e.g. spoils) where they will not enter a stream or watercourse, and permanently store or dispose of materials according to *Chapter 7.3- Spoils Handling and Disposal*.
- 2) Prepare emergency action plans and provide training for crews for their role in various emergency response scenarios that include steps to:
 - inspect and assess the site for potential hazards to workers, public safety and the environment,
 - notify the appropriate public safety officials,
 - notify appropriate agencies (contact numbers are listed in the table on page 10-6), and
 - respond to emergencies in a safe manner.

DANGER: Notify the County Office of Emergency Services, or the State Office of Emergency Services (OES) at 800-852-7550, or the local fire department when a hazardous materials spill occurs.

- 3) When an emergency situation is significantly impacting, or could impact, a stream system (for example, if the natural flow of a watercourse is disrupted by a large flood or landslide), seek the advice of appropriate experts prior to performing permanent repair work, which may include:
 - Engineering, environmental and planning staff
 - Agency personnel (DFG, NMFS, RWQCB)
 - Hydrologists or Hydraulic Engineers
 - Geologists
 - Geomorphologists
 - Geotechnical Engineers
 - Fisheries and Wildlife Biologists
- 4) When an emergency involves the discharge of hazardous substances or pollutants, implement Water Management BMPs and Sediment Management BMPs to contain pollutants and prevent them from entering drainage systems, streams, or watercourses.
- 5) During an emergency response that involves erosion, slope failure or embankment failure, implement Sediment Control BMPs to control the discharge of sediment, and Erosion Control BMPs or Streambank Protection BMPs to prevent further damage and, if possible, restore the damaged area. In addition, Water Management BMPs should be implemented as needed to keep runoff from entering or leaving the repair area. Refer to *Chapter 7.1-Erosion Control* and *Ch. 6.4- Streambank Stabilization* for additional information. Remedial actions should include biotechnical designs where practicable.
- 6) Use the following guidelines for modification or removal of large woody debris under emergency conditions:
 - If in doubt as to the best way to handle large woody debris in a stream, consult with DFG personnel.



- Log jams on public property that are damaging or immediately threatening the integrity of roads, bridges, culverts and other public facilities or private developments during high flows may be modified to reduce or halt damage and direct flow toward a more desirable path.
 - Consider opportunities to *modify* the debris jam to halt damage and direct flow toward a more desirable path.. Only remove (as opposed to modify) logs and debris from streams as a “last resort” (i.e. failure to remove them will certainly cause damage to an essential county facility).
 - Take precautions to ensure that modifications of log or debris jams will not cause damage downstream to culverts and other structures.
 - When modifying log jams, leave trees, logs and/or stumps in the longest lengths and diameters practicable for removal and hauling. If logs must be cut from fallen trees, leave as much as possible of the main trunk (12 feet plus is desirable) attached to the rootball and only cut branches obstructing flow.
 - Limit modifications or removal to materials higher than approximately 2 feet above the streambed (i.e. above knee height) to preserve some instream habitat features, unless the log or debris jam is immediately upstream of a culvert or bridge, or if permit conditions require otherwise.
 - Incorporate large woody debris removed from water bodies into streambank repairs or cribbing at a nearby location, or transport to an approved storage site for later use.
 - Non-emergency debris maintenance can only be undertaken after the appropriate agency permits have been obtained. Refer to the permits section below for additional details.
- 7) Emergency repairs should be thoroughly inspected after the emergency is over, and final repairs should be made using the appropriate Upslope Erosion Control BMPs or Streambank Protection BMPs. Remedial actions should include biotechnical designs where practicable.
- 8) Photo-document emergency actions for after-the-fact consultations.
- 9) Document all BMPs, including use of a biological monitor, that are completed as part of emergency actions for after-the-fact consultations.



AGENCY CONTACT INFORMATION FOR EMERGENCY NOTIFICATION

Agency Contact	Sonoma	Marin	San Mateo	Santa Cruz	Monterey
Department of Fish and Game Streambed Alteration Program					
Bay Delta Headquarters Yountville, CA (707) 944-5520	X	X	X	X	
Central Region Headquarters Fresno, CA (559) 243-4005					X
U.S. Army Corps of Engineers Regulatory Branch					
San Francisco District San Francisco, CA (415) 503-6795	X	X	X	X	X
Regional Water Quality Control Board 401 Certification					
North Coast RWQCB Santa Rosa, CA (707) 576-2220	X				
San Francisco Bay RWQCB Oakland, CA (510) 622-2300		X	X		
Central Coast RWQCB San Luis Obispo, CA (805) 549-3147				X	X
NOAA Fisheries Northern CA Habitat Coordinator					
Southwest Region Santa Rosa, CA (707) 575-6050	X	X	X	X	X
U.S. Fish & Wildlife Service					
Coast-Bay Delta Branch, Sacramento Field Office Sacramento, CA (916) 414-6625	X	X	X	X	X
California Coastal Commission					
North Central Coast District San Francisco, CA (415) 904-5260	X	X	X		
Central Coast District Santa Cruz, CA (831) 427-4863				X	X



BMP TOOLBOX

Road Surface BMPs

- ✓ Rolling Dip

Culvert BMPs

- ✓ Culvert Hydraulics Diagram
- ✓ Culvert Plugging Diagram
- ✓ Energy Dissipater

Erosion Control BMPs

- ✓ Blankets/Geotextile Fabrics
- ✓ Coir Log/Straw Roll
- ✓ Mulching
- ✓ Planting
- ✓ Plastic Covering
- ✓ Rock Breast Wall
- ✓ Broadcast Seeding
- ✓ Surface Roughening and Soil Tracking
- ✓ Stepped or Terraced Slope
- ✓ Coir Log/Straw Roll

Sediment Management BMPs

- ✓ Check Dam – Rock
- ✓ Check Dam – Straw Bale
- ✓ Containment of Concrete Pours
- ✓ Concrete Washout
- ✓ Sedimentation Trap/Sump
- ✓ Silt Fence
- ✓ Silt Mat Inlet
- ✓ Siltation Pond/Settling Pond
- ✓ Storm Drain Inlet Protection
- ✓ Sweeping
- ✓ Turbidity Curtain

Streambank Protection - Bioengineering BMPs

- ✓ Brush mattress
- ✓ Fabric Reinforced Earth Fill with Brush Layering
- ✓ Large Woody Debris Revetment
- ✓ Wattles/Fascine
- ✓ Live Stakes

Streambank Protection - Hardscape BMPs

- ✓ Boulder/Riprap
- ✓ Streambed Gravel

Water Management BMPs

- ✓ Aqua Barrier



- ✓ Asphalt Berm
- ✓ Cofferdam
- ✓ Dewatering
- ✓ Diversion Berm
- ✓ Fish Exclusion
- ✓ Sandbag
- ✓ Slope Drain – Temporary
- ✓ Slope Drain – Overside
- ✓ Stream Bypass (Water Diversion)



PERMITS

10.1 EMERGENCY RESPONSE	
Activity or Condition	Required permit or limitation
<p>Project proponents are not required to notify DFG or obtain a Streambed Alteration Agreement before commencing the following emergency work under the following conditions:</p> <ol style="list-style-type: none"> 1. immediate emergency work necessary to protect life or property; 2. immediate emergency repairs to public service facilities under specified circumstances; and 3. emergency projects undertaken, carried out, or approved by a public agency to maintain, repair, or restore an existing highway, as defined, within the existing right-of-way of the highway, damaged as a result of a fire, flood, storm, earthquake, land subsidence, gradual earth movement, or landslide, within one year of the damage. Work needed in the vicinity above and below a highway may be conducted outside of the existing right-of-way, if it is needed to stop ongoing or recurring mudslides, landslides, or erosion to their pre-damage condition and functionality. This exception does not exempt any project undertaken, carried out, or approved by a public agency to expand or widen a highway damaged by fire, flood, storm, earthquake, land subsidence, gradual earth movement, or landslide. 	<ul style="list-style-type: none"> • DFG regulations Fish & Game Code Section 1602 (f)
<ul style="list-style-type: none"> • Emergency work 	<ul style="list-style-type: none"> • CEQA (Sect. 15269) has similar conditions to DFG conditions above
<ul style="list-style-type: none"> • Emergency instream work • 	<ul style="list-style-type: none"> • DFG must be given written notification of emergency work within 14 days after work begins
<ul style="list-style-type: none"> • Emergency work 	<ul style="list-style-type: none"> • COE requires a post-project 404 permit. Nationwide Permit #3 authorizes the repair, rehabilitation, or replacement of those structures destroyed by storms, floods, fire or other discrete events, provided the repair is begun (or under contract to begin) within 2 years of the date of their destruction or damage.



10.1 EMERGENCY RESPONSE	
Activity or Condition	Required permit or limitation
<ul style="list-style-type: none"> • Emergency Work 	<ul style="list-style-type: none"> • RWQCB post-project 401 permit
<ul style="list-style-type: none"> • Emergency Work 	<ul style="list-style-type: none"> • Consult with NOAA Fisheries and U.S. Fish and Wildlife Service.

NOTE: Additional remedial work may be required by these agencies as a condition of post-project permits. If the work was implemented poorly, it may have to be replaced later, thus requiring more work and additional consultations.



10.2 EMERGENCY SLIDE AND WASHOUT REPAIR

DESCRIPTION

Slides and washouts or slip outs are typically caused by the impact of heavy rainfall, subsurface water, loss of support, loss of vegetation, concentrated runoff or freeze /thaw conditions on unstable or saturated soils. Slides and washouts can be caused by the events described, but those events are often only the trigger at improperly designed or constructed road features. Many of our County roads are poorly located historically and fraught with design problems . Slides and washouts can be caused by cutbank failures, ditch diversion and over the bank runoff due to improper or infrequent maintenance of ditches, culverts, and road surface (slope and grading). Slides and washouts can often be prevented with proper design and construction maintenance BMPs. For example, frequent slides and washouts along a particular stretch of road can be helped by cleaning ditches, and culverts, or eliminated by installing additional road features such as rolling dips, ditch relief culverts, or upgraded stream crossings with critical dips.

Emergency slide or washout repair activities may include: removal of slide/washout material from the road right of way; backfilling or stabilizing the slope, reestablishment of damaged roadway features; repairing and cleaning drainage system, and revegetating, and/or armoring with rock.

Slides and washouts are treated as emergencies if their impact could result in an unacceptable hazard to life, a significant loss of property, or an immediate, unforeseen, and significant economic hardship if corrective action is not immediately taken. Routine repair of minor slides under non-emergency conditions is discussed in *Chapter 7.2 -Minor Slide Repair*. Long term repair of major slides is generally a large project with an extensive planning and design component, and is not covered in this manual.

ENVIRONMENTAL CONCERNS

- ✓ Delivery of sediment, organic debris, asphalt, and other potential pollutants into the stream or storm water drainage system.
- ✓ Damage to stream or riparian habitat from the slide itself or from heavy equipment use instream or in the riparian zone.

BMP OBJECTIVES

- ✓ Reduce delivery of sediment into streams, storm drains and watercourses.
- ✓ Protect water quality and stream habitat by removing slide material and restoring streamflow.



BEST MANAGEMENT PRACTICES

- 1) Comply with general emergency response standards (*Chapter 10.1- Emergency Response*).
- 2) Set up the work area in such a way that vehicles will not track mud and debris in and out to the maximum extent practicable.
- 3) Protect storm drain inlets and watercourses using Water Quality Protection / Sediment Control BMPs.
- 4) During the emergency response, concentrate on controlling runoff flowing into and out of the repair area to the extent feasible using Water Management BMPs. Decrease sediment leaving the repair area using Water Quality Protection / Sediment Control BMPs. Stabilize the slide or washout using Upslope Erosion Control BMPs or Streambank Protection BMPs to prevent further damage and, if possible, restore the damaged area . See *Chapter 7.1- Erosion Control* or *Chapter 6.4- Streambank Stabilization*, for additional information. Remedial actions should include bioengineering designs where practicable.
- 5) Implement erosion and sediment control BMPs on or around stockpiles to keep materials from eroding into a stream or watercourse. Remove debris for proper long-term storage or disposal once the emergency is under control (*Chapter 7.3- Spoils Handling and Disposal*).
- 6) If fish-bearing streams are impacted, follow Water Management BMPs for water diversion and fish exclusion to the maximum extent practicable during the emergency slide repair. Consult a hydrologist or fish biologist with DFG or NOAA Fisheries prior to performing the work. (See *Permits* below for notification requirements.)
- 7) Temporarily store materials where they will not enter a stream or watercourse, and permanently store or dispose of materials according to *Chapter 7.3 - Spoils Handling and Disposal*.
8. Emergency repairs should be thoroughly inspected after the emergency is over, and final repairs should be made using the appropriate Upslope Erosion Control BMPs or Streambank Protection BMPs. Remedial actions should include biotechnical designs where practicable.



BMP TOOLBOX

Road Drainage BMPs

- ✓ Rolling Dip

Culvert BMPs

- ✓ Culvert Hydraulics Diagram
- ✓ Culvert Plugging Diagram
- ✓ Energy Dissipater

Erosion Control BMPs

- ✓ Blankets/Geotextile Fabrics
- ✓ Coir Logs/Straw Rolls
- ✓ Mulching
- ✓ Planting
- ✓ Plastic Covering
- ✓ Rock Breast Wall
- ✓ Hydroseeding
- ✓ Silt Mat Inlet
- ✓ Surface Roughening & Soil Tracking
- ✓ Stepped or Terraced Slope

Streambank Protection - Bioengineering BMPs

- ✓ Brush mattress
- ✓ Joint Planting
- ✓ Large Woody Debris Revetment
- ✓ Wattles/Fascines
- ✓ Live Stakes
- ✓ Fabric Reinforced Earth Fill with Brush Layering

Streambank Protection - Hardscape BMPs

- ✓ Boulder/Riprap
- ✓ Streambed Gravel

Water Management BMPs

- ✓ Aqua Barrier
- ✓ Cofferdam
- ✓ Dewatering
- ✓ Diversion Berm
- ✓ Sandbag
- ✓ Slope Drain – Temporary
- ✓ Slope Drain – Overside
- ✓ Stream Bypass (Water Diversion)
- ✓ Fish Exclusion

Sediment Management BMPs

- ✓ Brush Packing
- ✓ Storm Drain Inlet Protection
- ✓ Sand Bag
- ✓ Sedimentation Trap/ Sump



- ✓ Silt Fence
- ✓ Siltation Pond/Settling Pond
- ✓ Sweeping
- ✓ Turbidity Curtain

PERMITS

10.2 EMERGENCY SLIDE AND WASHOUT REPAIR	
<ul style="list-style-type: none"> • Emergency instream work 	<ul style="list-style-type: none"> • DFG must be given written notification of emergency work within 14 days after work begins, according to the Fish and Game Code. • COE post-project 404 permit. • RWQCB post-project 401 permit. • Consult DFG and NOAA biologists before performing work on fish-bearing streams. • Consult with U.S. Fish and Wildlife Service for other species of concern that might be affected (i.e. tidewater gobi, California freshwater shrimp, etc.)



10.3 ACCIDENT CLEAN UP

DESCRIPTION

County road and maintenance crews may have to respond to accidents on county roads involving spills of debris or hazardous materials. The accident may be due to: a) county activity, or b) activity by a non-county entity or individual, which the county is assisting in cleaning up. Activities include: hazard assessment, traffic control, isolation, containment, identification, and proper removal and disposal of spilled substances on the road right-of-way.

ENVIRONMENTAL CONCERNS

- ✓ Discharge of spilled materials into streams or watercourses.
- ✓ Damage to aquatic habitat at the site of the spill and downstream.
- ✓ Lethal impact to fish and aquatic organisms.
- ✓ Damage to riparian areas during clean up.
- ✓ Pollutants from equipment entering the streams or watercourses.

BMP OBJECTIVES

- ✓ Prevent spilled materials from entering streams or watercourses
- ✓ Reduce sediments entering storm drain inlets and watercourses.

BEST MANAGEMENT PRACTICES

- 1) Response to accidents should be addressed by and comply with a local spill contingency plan and emergency operations plan. County personnel responding to accidents should be periodically trained in accident response and automotive fluid spill clean up. Work should comply with the general emergency response standards in *Chapter 10.1 - Emergency Response*.
- 2) Only specially trained and equipped response teams should respond to hazardous materials or hazardous waste spills. County maintenance personnel should be trained in the appropriate notification requirements if they suspect that a hazardous materials or hazardous waste spill has occurred, and they should stay clear of the area pending further instructions from responding agency personnel.
- 3) County maintenance crews can assist emergency response personnel (i.e., the CHP, Sheriff or fire department) with vehicle accident cleanup or traffic control, and should take direction from these agencies for their work. In the event that county personnel are the first to have knowledge of the accident, appropriate authorities must be immediately notified and consulted. (See *Permits* below.)



- 4) County staff should have available and be trained to use emergency spill response equipment such as absorbent spill kits, river booms, and oil skimmers ,at all maintenance yards and other strategic spill response sites. Sufficient equipment should be available to cleanup or contain at least a moderate petroleum product or non-hazardous spill (1-50 gallons).

- 5) Contain spilled material and prevent it from entering drain inlets and watercourses using Water Quality Protection / Sediment Control BMPs. Containerize absorbent and spilled material for removal from the site as soon as possible.

BMP TOOLBOX

Planning and Prevention BMPs

- ✓ Small Spill Kit
- ✓ Large Spill Kit

Sediment Management BMPs

- ✓ Silt Fence
- ✓ Siltation Pond/Settling Pond
- ✓ Storm Drain Inlet Protection
- ✓ Sweeping
- ✓ Turbidity Curtain

Water Management BMPs

- ✓ Asphalt Berm
- ✓ Diversion Berm
- ✓ Sand Bag

Valuable References

- ✓ County or State Spill Contingency Plan
- ✓ County Emergency Operations Plan
- ✓ DFG Pollution Response Manual (1998), Sacramento
- ✓ Spill Responses Training Manual, DFG – Office of Spill Prevention and Response (OSPR), Sacramento
- ✓ Upper Sacramento Spill Contingency Plan (Resources Agency & DFG) – based on experience of the toxic “Cantara Spill”: by Southern Pacific Railroad

PERMITS

10.3 ACCIDENT CLEAN-UP	
Activity or Condition	Required permit or limitation
	<ul style="list-style-type: none"> • Follow notification protocols established by your County Office of Emergency Services.



10.4 EMERGENCY UTILITY REPAIRS

DESCRIPTION

County maintenance crews may be called upon to repair irrigation lines, sprinklers or valves, as well as broken waterlines, sewer lines or storm drain lines that are damaged, could pollute streams or cause flooding or erosion. In some cases, significant work beyond the repair of sewer, water or storm drain lines may be needed just to stabilize the emergency – for example, a failing bank that threatens a pump station. Such emergency repairs may require significant excavation, construction of temporary access, bank stabilization, dewatering, and so on. Please refer to other sections of this manual for environmental protection BMPs associated with ancillary activities.

Note: Regular permit requirements always apply for *non-emergency* work. Please carefully distinguish bona fide emergency work according to emergency permit requirements. (See Permit sections in this chapter.)

ENVIRONMENTAL CONCERNS

- ✓ Flooding or pollution of streams from discharges associated with broken water and sanitary sewer utilities .
- ✓ Excessive erosion caused by discharges associated with broken utilities.
- ✓ Sedimentation or pollution caused by repair work during emergencies.
- ✓ Lethal impact to fish and aquatic organisms.

ENVIRONMENTAL BMP OBJECTIVES

- ✓ Prevent accidents, damage to infrastructure or harm to public health that may be caused by discharges flowing from broken utilities.
- ✓ Prevent pollution caused by discharges from broken sanitary sewer utilities.
- ✓ Prevent erosion and sediment delivery to streams caused by discharges from broken water and sanitary sewer utilities, non-functional drainage systems or soil disturbance during utility repair.
- ✓ Contain any spill associated with broken pipe.
- ✓ Restore proper drainage.

BEST MANAGEMENT PRACTICES

- 1) Shut off utility or drainage system to prevent further damage to roadway or structure. Contact utility company, city or local utility district to do this if necessary.



- 2) Notify proper authorities immediately. Effluent from sewer lines is considered a health hazard. Local fire department or Hazardous Material Response Team (HMRT) and the County Department of Environmental Health should be notified immediately to determine the proper protocol for management of sewage leaks.
- 3) Identify and protect drain inlets and watercourses using appropriate Water Management, Erosion Control and Sediment Management BMPs. County Engineering may be able to help you locate drain inlets or determine their drainage configuration so the spill can be stopped before it reaches a water body.
- 4) Set up the work area in such a way that vehicles will not track mud and debris in and out to the maximum extent practicable.
- 5) Implement Erosion Control and Sediment Management BMPs on or around excavation areas and stockpiles to keep materials from eroding into a stream or watercourse. Reuse soil as backfill or remove for proper long-term storage or disposal once the emergency is under control (*Chapter 7.3 - Spoils Handling and Disposal*).
- 6) When containing a spill associated with a broken pipe, it may be necessary to implement Large Spill Kit BMPs, which include use of absorptive materials and provisions for containment to prevent the spill from reaching nearby water bodies (e.g. use of temporary bladders in stream to limit spill dispersion”]
- 7) Once the utility is repaired, identify any damage caused by erosion to slopes or impacts to streams and apply appropriate Erosion Control BMPs or Streambank Protection BMPs to prevent further erosion and repair the damage. See *Chapter 7.1 -1 Erosion Control* and *Chapter 10.2 - Emergency Slide and Washout Repair* for additional guidance.
- 8) Monitor the repaired utility periodically until you are confident the repair was effective.

BMP TOOLBOX

Water Management BMPs

- ✓ Diversion Berm
- ✓ Sandbag
- ✓ Slope Drain – Temporary
- ✓ Slope Drain – Overside

Sediment Management BMPs

- ✓ Storm Drain Inlet Protection
- ✓ Silt Fence

Planning and Prevention

- ✓ Large Spill Kit
- ✓ Small Spill Kit



Useful Information

- ✓ Storm Drain System Maps or GIS

Valuable References

- ✓ County or State Spill Contingency Plan
- ✓ County Emergency Operations Plan
- ✓ DFG Pollution Response Manual (1998), Sacramento
- ✓ Spill Responses Training Manual, DFG – Office of Spill Prevention and Response (OSPR), Sacramento

PERMITS

10.4 EMERGENCY UTILITY REPAIRS	
Activity or Condition	Required permit or limitation
<ul style="list-style-type: none">• Releases from sewer pipes	<ul style="list-style-type: none">• Follow notification protocols established by your County Office of Emergency Services.
<ul style="list-style-type: none">• Emergency instream work	<ul style="list-style-type: none">• DFG must be given written notification of emergency work within 14 days after work begins.• COE post-project CWA Section 404 permit. The Corps Emergency Permit defines “emergency” consistent with the CEQA and NEPA definitions. The COE limits remediation allowed under the emergency permit to the minimum necessary to stabilize the situation. Otherwise, you <i>must</i> follow normal permit routes.• RWQCB post-project CWA Section 401 permit• Contact NOAA Fisheries and U.S. Fish and Wildlife Service if listed species will be affected.



APPENDIX A – BMP TOOLBOX

TABLE OF CONTENTS

ROAD DRAINAGE BMPs	A-5
Rolling Dip.....	A-7
Outsloping.....	A-11
Ditch Relief Culverts	A-15
Critical Dip.....	A-21
Berm Removal.....	A-25
CULVERT BMPs	A-27
Culvert Hydraulics- Diagram.....	A-29
Culvert Plugging- Diagram.....	A-31
Culvert Sizing.....	A-33
Culvert Inlet Sediment Trap.....	A-39
Trash Racks.....	A-41
Energy Dissipater.....	A-43
Back-Flooding Weirs	A-45
Baffles for Fish Passage	A-47
EROSION CONTROL BMPs	A-51
Blankets/Geotextile Fabric.....	A-52
Coir Fabric-Netting	A-61
Coir Logs/Straw Rolls	A-63
Broadcast Seeding	A-67
Hydroseeding	A-69
Mulching	A-71
Planting	A-73
Surface Roughening and Soil Tracking.....	A-77
Stepped or Terraced Slope.....	A-82
Plastic Covering	A-83
Rock Breast Wall.....	A-85
Vegetated Geoberm Toe Wall.....	A-87
SEDIMENT MANAGEMENT BMPs	A-91
Brush Packing	A-93
Check Dam – Rock.....	A-97
Check Dam – Straw Bale.....	A-101
Concrete Washout	A-103
Containment of Concrete Pours	A-107
Sitl Mat Inlet	A-109

Silt Mat/Vegetated Grassy Swale	A-113
Silt Fence	A-117
Sedimentation Trap/Sump	A-125
Siltation Pond/Settling Pond	A-129
Storm Drain Inlet Protection	A-135
Sweeping	A-139
Turbidity Curtain	A-141
WATER MANAGEMENT BMPs	A-145
Asphalt Berm	A-147
Aqua Barrier	A-149
Cofferdam	A-151
Dewatering	A- 157
Diversion Berm	A-161
Fish Exclusion	A-163
Level Spreader	A-165
Sandbag	A-169
Slope Drain – Temporary	A-171
Slope Drain – Overside	A-175
Slope Drain- Swale	A-179
Stream Bypass (Water Diversion)	A-181
STREAMBANK PROTECTION – BIOTECHNICAL BMPs	A-185
Brush Mattress	A-187
Harvesting and Handling of Woody Cuttings	A-193
Large Woody Debris Revetment	A-195
Willow Wall Revetment	A-199
Live Pole Drain	A-203
Live Stakes	A-205
Fabric Reinforced Earth Fill with Brush Layering	A-209
Wattles/Fascines	A-213
STREAMBANK PROTECTION – HARDSCAPE BMPs	A-219
Boulder/Riprap	A-221
Streambed Gravel	A-225
Vegetated Concrete Cribwall	A-227
PLANNING AND PREVENTION	A-229
Seasonal Planning	A-231
Small Spill Kit	A-237
Large Spill Kit	A-239

<p>BMP TOOLBOX</p> <p>ALPHABETICAL TABLE OF CONTENTS</p>
--

Aqua Barrier	A-149
Asphalt Berm	A-147
Back-Flooding Weirs	A-45
Baffles for Fish Passage	A-47
Berm Removal.....	A-25
Blankets/Geotextile Fabric.....	A-52
Boulder/Riprap.....	A-221
Broadcast Seeding.....	A-67
Brush Mattress.....	A-187
Brush Packing	A-93
Check Dam - Rock.....	A-97
Check Dam - Straw Bale.....	A-101
Cofferdam.....	A-151
Coir Fabric-Netting.....	A-61
Coir Logs/Straw Rolls.....	A-63
Concrete Washout.....	A-103
Containment of Concrete Pours.....	A-107
Critical Dip.....	A-21
Culvert Hydraulics- Diagram.....	A-29
Culvert Inlet Sediment Trap.....	A-39
Culvert Plugging- Diagram.....	A-31
Culvert Sizing.....	A-33
Dewatering.....	A- 157
Ditch Relief Culverts.....	A-15
Diversion Berm.....	A-161
Energy Dissipater.....	A-43
Fabric Reinforced Earth Fill with Brush Layering.....	A-209
Fish Exclusion.....	A-163
Harvesting and Handling of Woody Cuttings.....	A-193
Hydroseeding.....	A-69
Large Spill Kit.....	A-239
Large Woody Debris Revetment.....	A-195
Level Spreader.....	A-165
Live Pole Drain.....	A-203
Live Stakes.....	A-205
Mulching.....	A-71
Outsloping.....	A-11

Planting.....	A-73
Plastic Covering.....	A-83
Rock Breast Wall.....	A-85
Rolling Dip.....	A-7
Sandbag	A-169
Seasonal Planning.....	A-231
Sedimentation Trap/Sump.....	A-125
Silt Fence	A-117
Silt Mat/Vegetated Grassy Swale	A-113
Siltation Pond/Settling Pond.....	A-129
Silt Mat Inlet	A-109
Slope Drain - Overside.....	A-175
Slope Drain - Temporary.....	A-171
Slope Drain- Swale.....	A-179
Small Spill Kit.....	A-237
Stepped or Terraced Slope.....	A-82
Storm Drain Inlet Protection.....	A-135
Stream Bypass (Water Diversion)	A-181
Streambed Gravel.....	A-225
Surface Roughening and Soil Tracking	A-77
Sweeping	A-139
Trash Racks.....	A-41
Turbidity Curtain.....	A-141
Vegetated Concrete Cribwall.....	A-227
Vegetated Geoberm Toe Wall.....	A-87
Wattles/Fascines.....	A-213
Willow Wall Revetment.....	A-199

ROAD SURFACE BMPS

- **ROLLING DIP**..... A- 7
- **OUTSLOPING**..... A- 11
- **DITCH RELIEF CULVERTS**.....A-15
- **CRITICAL DIP**..... A- 21

BMP- ROLLING DIPS

DESCRIPTION

Rolling Dips are smooth, angled depressions constructed in the roadbed where the road grade reverses for a short distance and surface runoff is directed in the dip to the outside or inside of the road. Rolling Dips are intended to be used in sequence to drain the surface of the road, not the ditch. The dip causes storm water runoff to exit the road surface while allowing for passage of motor vehicles at reduced road speeds. No more than 150' of ditch should be connected to a rolling dip, and never downstream of a stream crossing unless a critical dip is present and maintained at the stream crossing.

APPLICATIONS

Appropriate for road surface drainage on any low-speed ranch or forest road. Rolling dips may be traveled on in winter if the road surface has sufficient rock and otherwise good drainage.

LIMITATIONS

- ✓ Never outlet rolling dips onto unstable or unprotected fill slopes.
- ✓ Do not construct rolling dips in areas of high-speed travel.
- ✓ Must be deep enough that it is not obliterated by normal grading, but not so deep that it is difficult to negotiate or a hazard to normal traffic.
- ✓ Not suitable for road grades much over 12%

CONSTRUCTION GUIDELINES

- 1) Excavate the trough of the rolling dip into the roadbed. The approach from up-road is long and shallow - from 50 to 80 feet long. The reverse grade or lip on the down-road side is more abrupt, running for about 15 feet. See Table 1.
- 2) Angle the axis of the dip no less than 30 degrees and up to 60 degrees to the road alignment. A steeper angle is required for steeper road grades.
- 3) The lowest portion of the dip should be 11 to 18 inches deep into the roadbed (see Table 1) with the cross-slope of the dip axis at least 1% greater than that of the original roadbed cross-slope.
- 4) Rock road base must be compacted into the surface of the dip to prevent rutting.
- 5) The outlet must be on stable ground or armored or otherwise stabilized.
- 6) Spacing between dips or other road surface cross drains is shown on Table 2.

- 7) Install signs in both directions alerting motorists and road maintenance crew to the dip.

BMP MAINTENANCE

- ✓ Instruct road maintenance personnel as to the function and design of rolling dips.
- ✓ Check outlet for erosion and repair as needed.
- ✓ Periodically inspect before and during rainy season. Remove sediment buildup, repair ruts.

BMP REMOVAL

- ✓ N/A

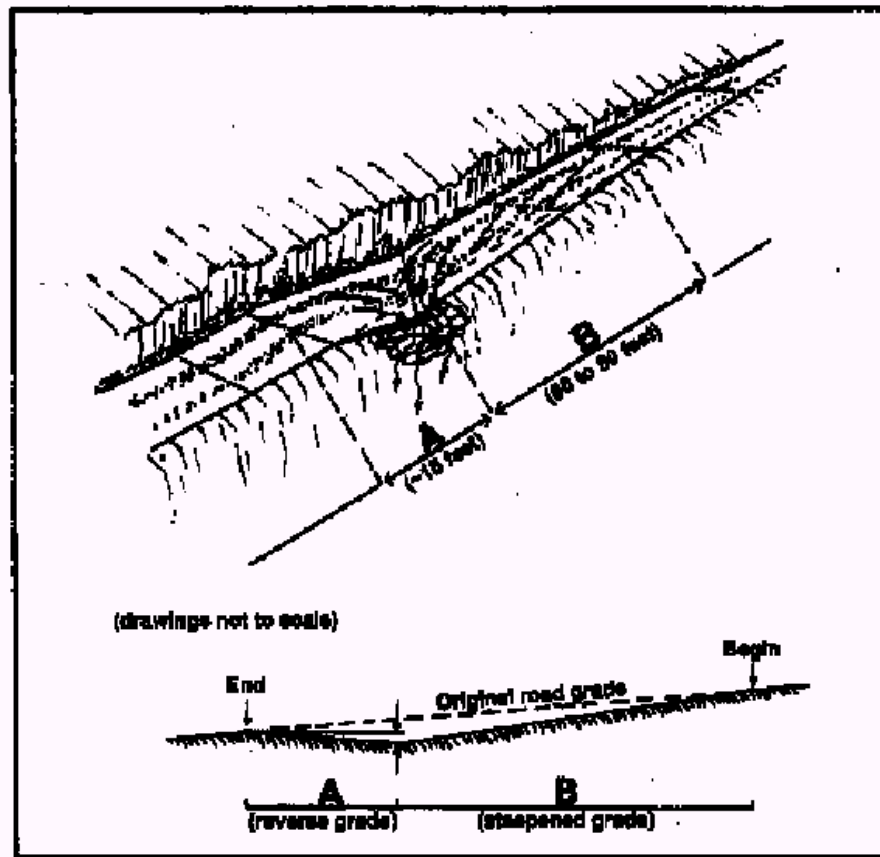

The up-road approach to the rolling dip (B) is several percent steeper than the approaching road and extends for 60 to 80 feet to the dip axis. The lower side of the structure (A) reverses grade over approximately 15 feet, and then falls down to rejoin the average road grade. It must be deep enough that it is not obliterated by normal grading, not so deep that it is difficult to negotiate or a hazard to normal traffic. The outward cross-slope of the dip axis should be at least 1% greater than the original road grade so it will drain properly.

(See page 2 for additional information)

Source:

Weaver, William E. PhD and Danny Hagans,
Pacific Watershed Associates. Handbook for
Forest and Ranch Roads. Prepared for the
Mendocino County Resource Conservation
District, June 1994.

ROLLING DIP

Sheet 1 of 2

Road grade (%)	Upslope approach (distance from up-road start of rolling dip to trough)(ft)	Reverse grade (distance from trough to crest) (ft)	Depth below average road grade at discharge end of trough(ft)	Depth below average road grade at upslope end of trough(ft)
< 6	55	15-20	0.9	0.3
8	65	15-20	1.0	0.2
10	75	15-20	1.1	0.1
12	85	20-25	1.2	0.1
> 12	100	20-25	1.3	0.1

Soil composition	Road gradient (%)		
	2% - 4%	5% - 8%	9% - 12%
Granitic or sandy	400	300	200
Clay or loam	500	400	250
Shale or gravel	600	500	300

¹ Distances used only to show importance of soil type in influencing drain spacing. Forestry operations are required to employ distances outlined in the Forest Practice Rules as a minimum.

Source:
 Weaver, William E. PhD and Danny Hagans,
 Pacific Watershed Associates. Handbook for
 Forest and Ranch Roads. Prepared for the
 Mendocino County Resource Conservation
 District, June 1994.

ROLLING DIP
 Sheet 2 of 2

BMP- OUTSLOPING

DESCRIPTION

Roads constructed with an outsloped pitch allow runoff to disperse along the entire road's edge instead of concentrating flow within an inboard ditch. The purpose is to minimize the interruption of surface and subsurface water patterns, minimize water concentration along roads, and maximize water dispersal.

APPLICATIONS

Used on low speed roads on side slopes where fillslopes are stable.

LIMITATIONS

- ✓ Rolling dips are required at intervals to disperse water off the road surface.
- ✓ A rocked or paved road surface is necessary to maintain an outsloped road.
- ✓ Outsloping may not be appropriate on curves or other areas where vehicles may slip off the outside edge. A crowned road or insloped road may be required in such cases.

CONSTRUCTION GUIDELINES

- 1) Frequency of rolling dips and the amount of outboard pitch required to maintain a good road varies with grade (see details).
- 2) When fillslopes are stable, the road should be designed with a minimum width and a gentle (3-4%) outslope.
- 3) Rolling dips are preferred to waterbars, which should be used only where winter use of the road is limited. Waterbars will break down or breach with extended traffic and create the need for higher maintenance.

BMP MAINTENANCE

- ✓ Roads should be inspected frequently to repair signs of erosion or wear on the surface and in the rolling dips or waterbars.

BMP REMOVAL

N/A

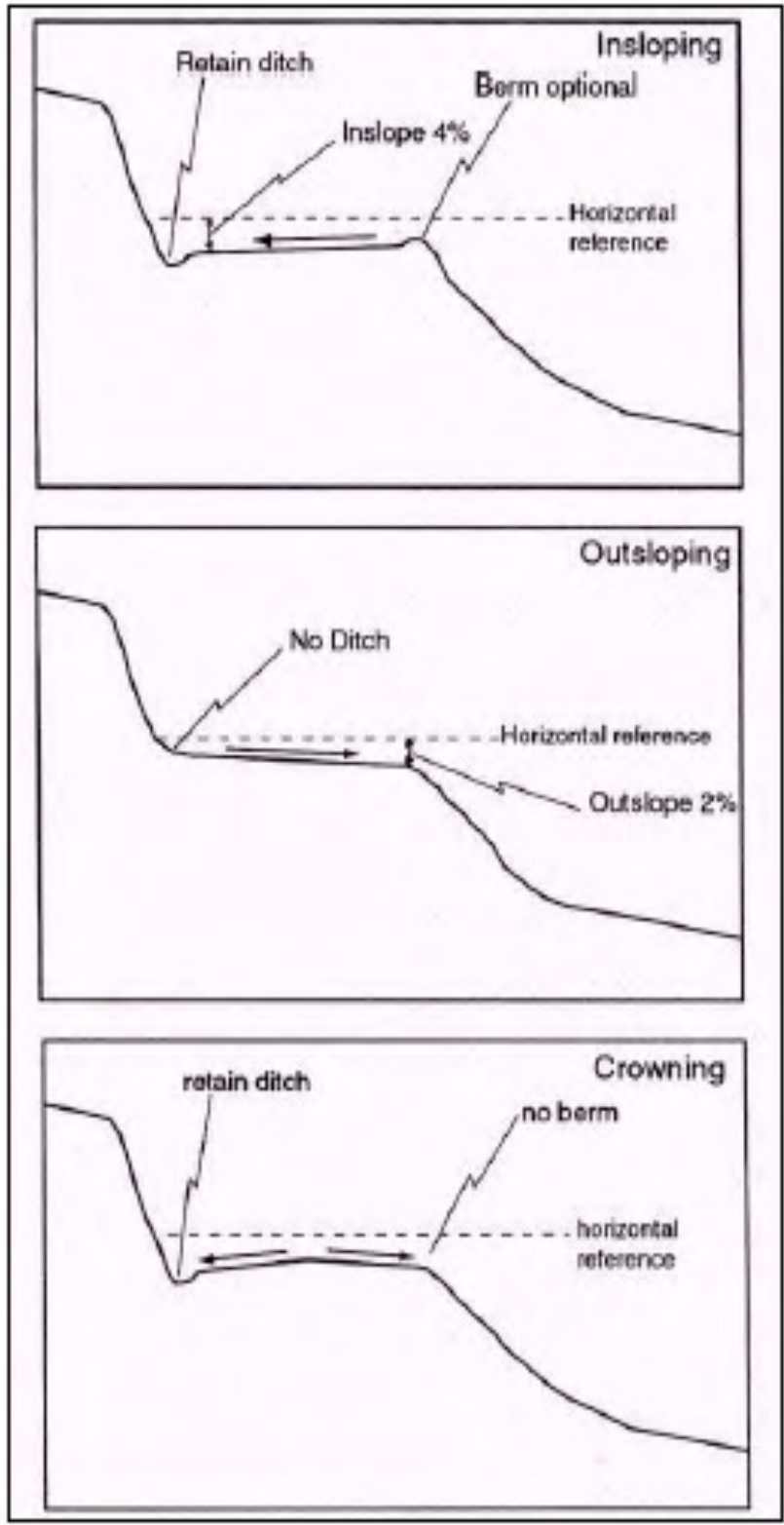

Utilizing road shape to reduce surface run-off rates. (DFG CA Salmonid Stream Habitat Restoration Manual Ch. X)

Maximum suggested road surface drainage spacing based on road gradient and soil composition			
Soil composition	Road gradient (%)		
	2% - 4%	5% - 8%	9% - 12%
Granitic or sandy	400	300	200
Clay or loam	500	400	250
Shale or gravel	600	500	300

te:
 en outsloping, rolling
 s should be used.

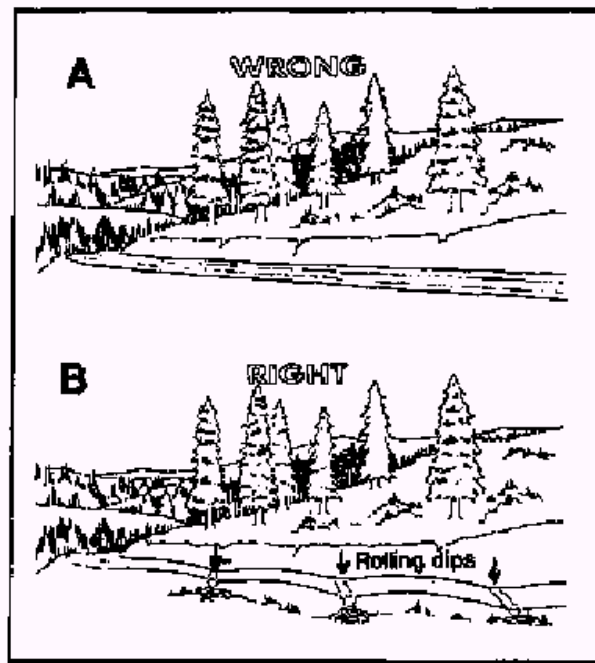

Source:
 Weaver, William E. PhD and Danny Hagans,
 Pacific Watershed Associates. Handbook for
 Forest and Ranch Roads. Prepared for the
 Mendocino County Resource Conservation
 District, June 1994.

OUTSLOPING

Sheet 2 of 2

BMP- DITCH RELIEF CULVERTS

DESCRIPTION

Ditch relief culverts (DRCs) divert water from an inside road ditch to an outside area beyond the outer edge of the road fill. Ditch relief culverts take the flow through or beneath the road surface. See also BMP-Rolling Dip which performs the same function but on top of the road surface. Ditch relief culverts may also be used to filter water in a buffer zone prior to entering a waterway.

LIMITATIONS

- ✓ Culverts should be designed and installed at intervals along the road that are close enough to prevent erosion of the ditch and at the culvert outfall, and at locations where collected water and sediment is not discharged directly into watercourses.
- ✓ Ditches should neither be discharged directly into the inlet of a watercourse crossing culvert, nor should ditch relief culverts discharge into a watercourse without first directing flow through an adequate filter strip.
- ✓ In addition to installing ditch relief culverts on either approach to watercourse crossings, it is also advisable to consider installing ditch drains before curves, above and below through-cut road sections, and before and after steep sections of the road.
- ✓ DRCs should not be used on erosive slopes without a downspout.

CONSTRUCTION GUIDELINES

- 1) In areas of high erosion and/or storm runoff, minimum ditch relief culvert sizes should be 18 inches in diameter, and never less than 12 inches in other areas.
- 2) A 10% grade to the culvert will usually be self cleaning. The culvert grade should also be at least 2% greater than the ditch which feeds it. The culvert should be placed at a 30 degree skew to the ditch to improve inlet efficiency and prevent plugging and erosion at the inlet.
- 3) Culverts should be installed at the gradient of the original ground slope, so it will emerge on the ground surface beyond the base of the fill. If not, either the fill below the culvert outlet should be armored with rock, or the culvert should be fitted with an anchored downspout to carry erosive flow past the base of the fill.
- 4) The pipe should be covered by a minimum of 1 foot of compacted soil, or a depth of 30% of its diameter, whichever is greater.
- 5) Inlet protection, such as rock armoring or drop structures, can be used to help minimize erosion.

- 6) On new roads, ditch flow should be culverted and discharged into buffer areas and filter strips before it reaches a watercourse crossing.
- 7) DRCs must be spaced frequently enough to carry ditch and road surface waters without creating erosive concentrated flows. See attached table for spacing guidelines.

BMP MAINTENANCE

- ✓ Regular inspection and maintenance to remove debris.
- ✓ To ensure proper working condition, culverts need to be inspected and maintained for any signs of erosion after storms.

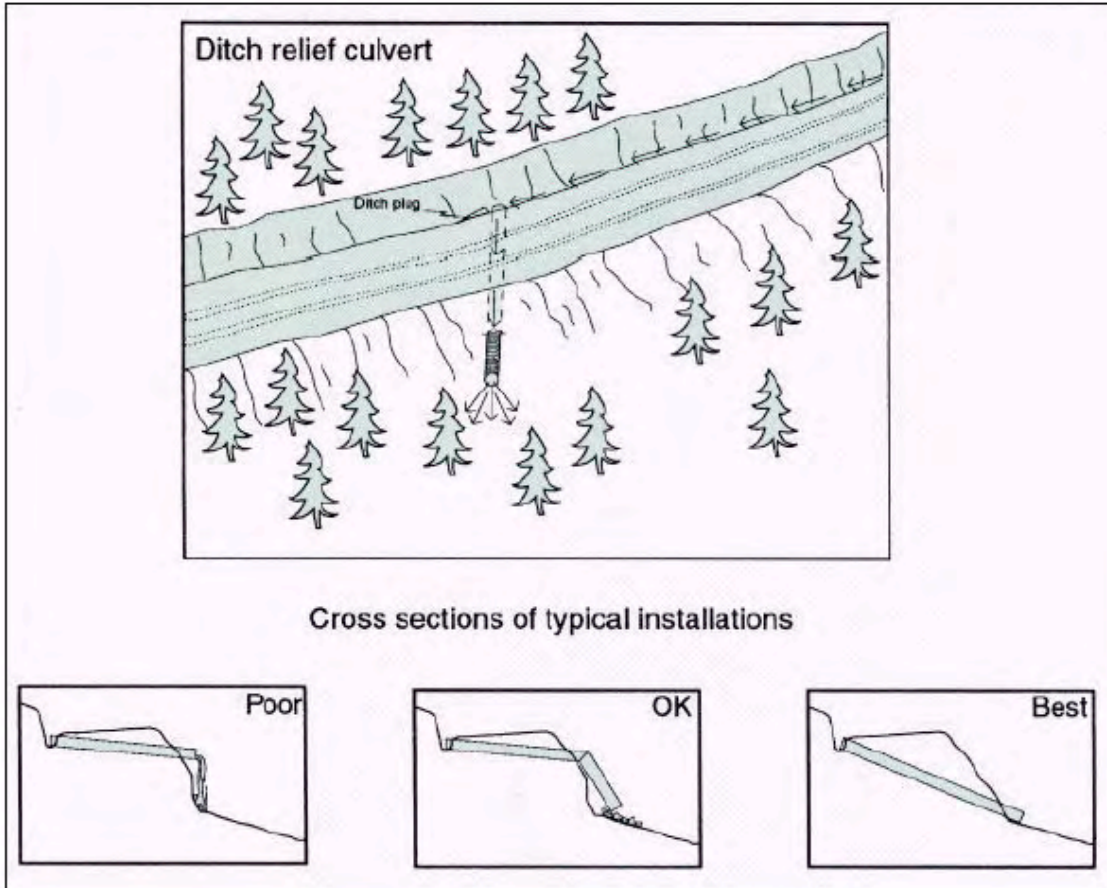

Typical ditch relief culvert installation. (DFG CA Salmonid Stream Habitat Restoration Manual. CH X, 2002).

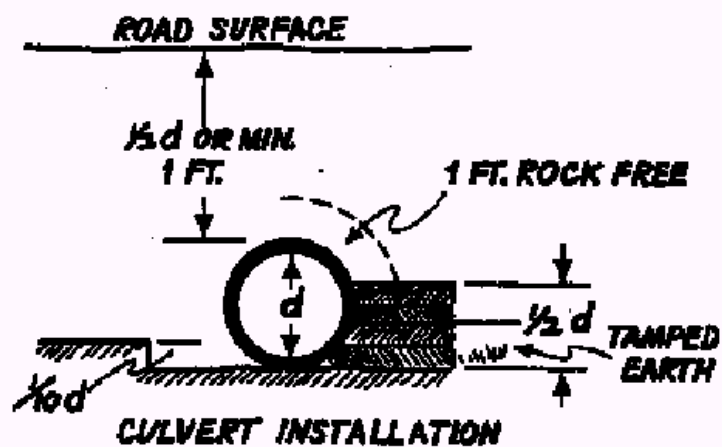
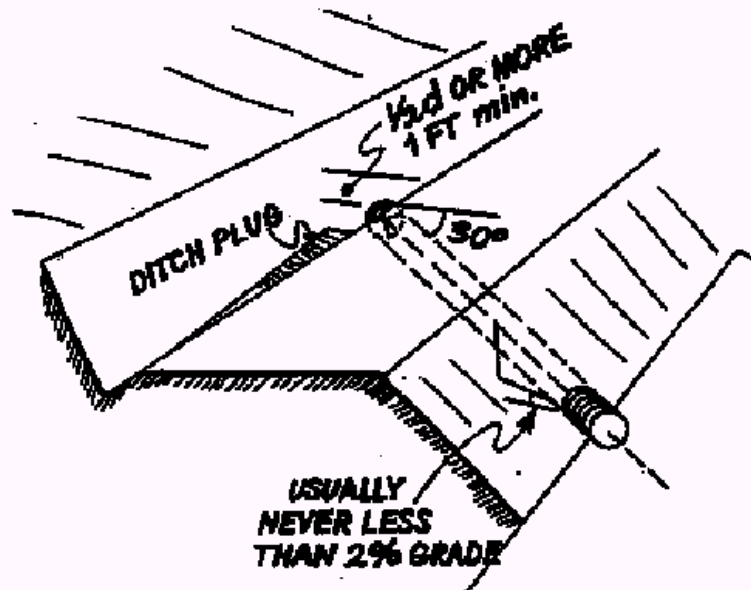

Source:

Weaver, William E. PhD and Danny Hagans,
Pacific Watershed Associates. Handbook for
Forest and Ranch Roads. Prepared for the
Mendocino County Resource Conservation
District, June 1994.

DITCH RELIEF CULVERTS

Sheet 1 of 2

Maximum suggested spacing for ditch relief culverts ¹ (ft)					
Road grade (%)	Soil erodibility				
	very high	high	moderate	slight	very low
2	600-800 ²				
4	530	600-800 ²			
6	355	385	600-100 ²		
8	265	425	525	600-800 ²	
10	160	340	420	535	
12	180	285	350	460	600-800 ¹
14	155	245	300	365	560
16	135	215	270	345	490
18	118	190	240	310	435

1. Adapted from Transportation Handbook U.S.D.A. Forest Service, R-6, 1966.
2. Spacing greater than 600 feet generally not recommended.

Where a road approaches a stream crossing (B), ditch flow should be culverted across the road (A, D) and discharged into a vegetated buffer that can filter the runoff before it reaches the watercourse. If the stream culvert plugs with debris or is topped by flood flows, flow will spill over the road at the change-in-grade at location "C" and back into the stream channel. (modified from M.D.S.L., 1991)

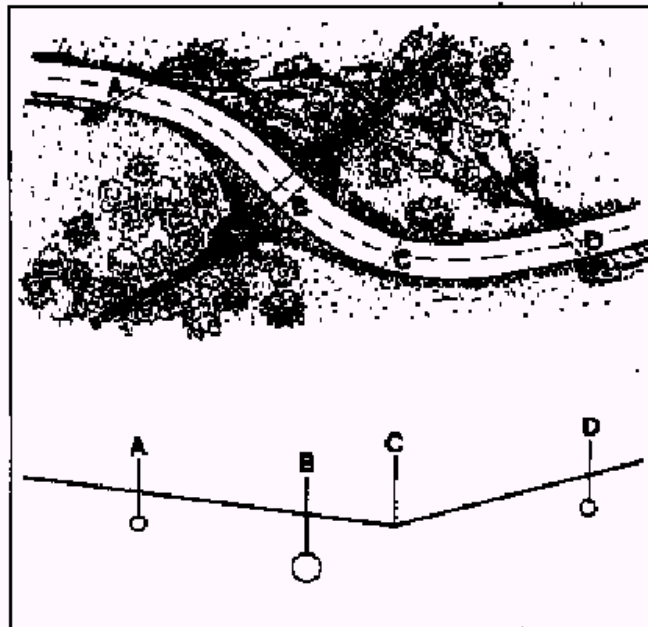

Source:
Weaver, William E. PhD and Danny Hagans,
Pacific Watershed Associates. Handbook for
Forest and Ranch Roads. Prepared for the
Mendocino County Resource Conservation
District, June 1994.

DITCH RELIEF CULVERTS

Sheet 2 of 2

BMP- CRITICAL DIP

DESCRIPTION

A relief outlet or drainage feature in the roadbed which captures overflow from culverted crossings and redirects the overflow back into the original channel. Construction may be similar to BMP – Rolling Dip (Road Surface BMPs).

APPLICATIONS

For stream crossings with high diversion potential wherever the road climbs through the crossing and one approach slopes away from the stream crossing. The Critical Dip will prevent stream diversion down the road if the culvert plugs.

LIMITATIONS

- ✓ Must be deep enough that it is not obliterated by normal grading, but not so deep that it is difficult to negotiate or a hazard to normal traffic.

CONSTRUCTION GUIDELINES

- 1) Stream crossings should be constructed to prevent diversion of flood overflow if the culvert were to become plugged. This can be done by designing the road to dip into and out of the stream at the crossing site or by installing a broad rolling dip on the down-road side of the crossing. This will allow the overflow to be directed back into the natural stream channel.
- 1) Road surface and fill slopes at the critical dip should be rocked or otherwise stabilized.
- 2) See BMP-Rolling Dip for more details.

BMP MAINTENANCE

- ✓ Instruct road maintenance personnel as to the function and design of rolling dips.
- ✓ Check outlet for erosion and repair as needed.
- ✓ Periodically inspect before and during rainy season. Remove sediment buildup, repair ruts.

BMP REMOVAL

- ✓ N/A

SOURCE

Weaver, William E. PhD and Danny Hagans, Pacific Watershed Associates. Handbook for Forest and Ranch Roads. Prepared for the Mendocino County Resource Conservation District, June 1994.

Upgraded stream crossing with Critical Dips installed to direct drainage.(DFG CA Salmonid Stream Habitat Restoration Manual Ch. X, 2002).

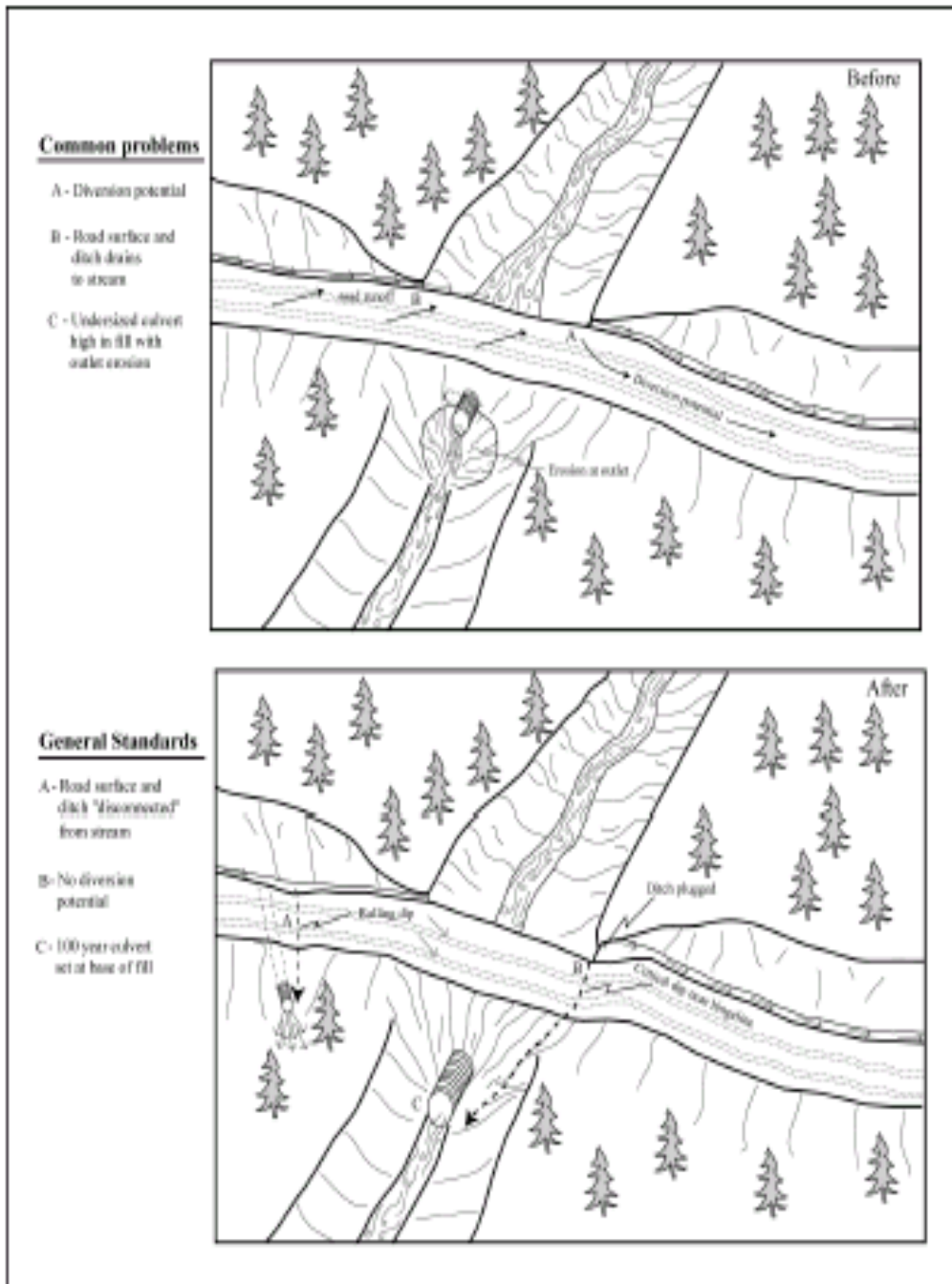

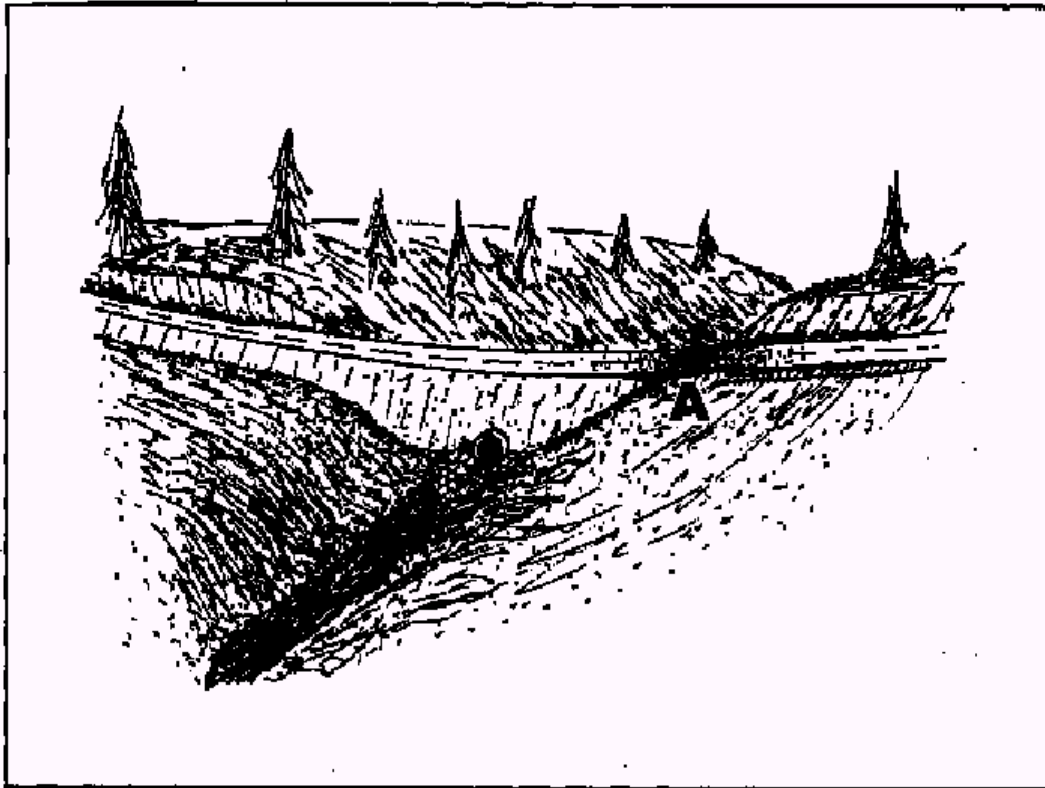

If culvert plugs, flow would reach the road surface and flow back into the channel at location "A" where the road changes grade.

See also: Rolling Dip

Source:
Weaver, William E. PhD and Danny Hagans,
Pacific Watershed Associates. Handbook for
Forest and Ranch Roads. Prepared for the
Mendocino County Resource Conservation
District, June 1994.

CRITICAL DIP

BERM REMOVAL

DESCRIPTION

This BMP refers to removal of specific berms (see below) along roadsides that have been created either as side-cast from road grading operations, constructed as roadside safety bumpers, or as water diversion barriers. These types of berms are typically made of soil or road base to a height of one-half to one and a half feet in height. Berms on the downslope side or outside of an outsloped road can allow water to concentrate on road surfaces for long distances.

APPLICATIONS

Removal or frequent breaching of berms in many cases is recommended to prevent water from concentrating and forming rills and gullies. *Frequent dispersal* of water off road surfaces is the key to road-related erosion control.

LIMITATIONS

- 1) Care must be taken so that spoils from berm removal are not deposited into a watercourse.
- 2) Some berms must be left in place where it is necessary to keep water from flowing onto sensitive areas.
- 3) Some berms may keep vehicles from sliding off the road – there are alternatives, however such as coarse road base with good traction, less road outslope, insloped or crowned road surfaces, or guard rails.

CONSTRUCTION GUIDELINES

- 1) Mark the specific areas for berm removal before grading begins.
- 2) Consider whether the berm or an alternative device is needed where slippery road surfaces are present, especially where roads outslope on steep embankments.
- 3) Wherever possible, pull the berm material back into the road and incorporate into the road surface. Care must be taken not to interrupt other drainage facilities such as **rolling dips** or **critical dips**. Moistening and compacting the material may be required.
- 4) If there is too much material to incorporate into the road surface, the material must be end-hauled to a stable area where it will not erode into a watercourse.
- 5) In some cases, specifically gentle slopes away from watercourses, pushing the material off the side of the road may be warranted. All areas of bare soil greater than 100 square feet should be seeded and mulched before the end of October.
- 6) The final surface grade where berms have been removed must be outsloped to allow water to run off the road surface to the downhill side.

BMP MAINTENANCE

- ✓ Where berm breaches plug, they must be unplugged. Winter monitoring before and/or after major storm events may be required.
- ✓ Where berms re-form, they must be removed.
- ✓ Tire tracks and ruts in dirt road surfaces may short-circuit the benefits of berm removal. Re-grading or digging ditch outlets by hand may be required.

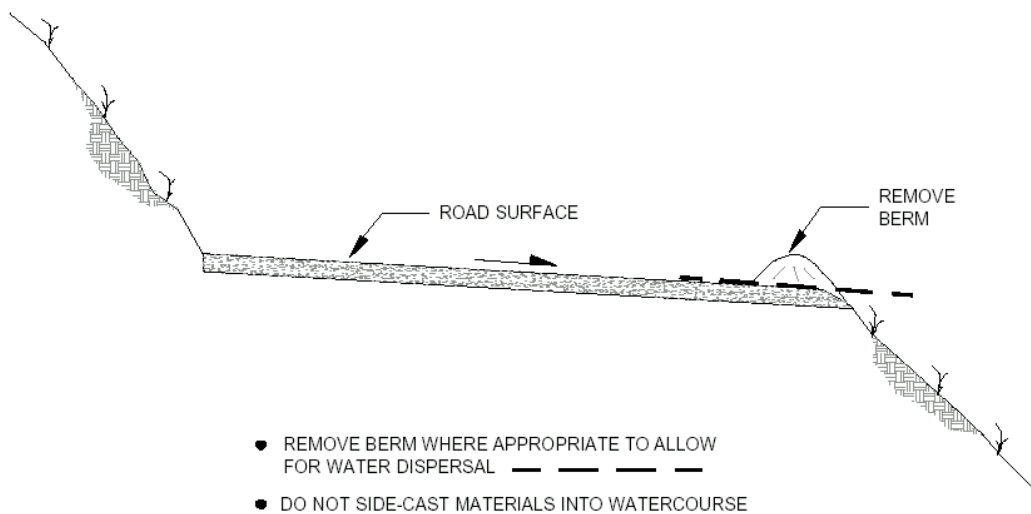

Source:
©Prunuske Chatham, Inc.
Occidental, CA

**BERM
REMOVAL**

Culvert BMPs

CULVERT HYDRAULICS- DIAGRAM	A-29
CULVERT PLUGGING- DIAGRAM.....	A-31
CULVERT SIZING.....	A-33
CULVERT INLET SEDIMENT TRAP.....	A-39
TRASH RACKS.....	A-41
ENERGY DISSIPATER.....	A-43
BACK-FLOODING WEIRS	A-45
BAFFLES FOR FISH PASSAGE IMPROVEMENT	A-47

Note: For detailed specifications on fish passage through county structures, see NOAA Fisheries Guidelines for Salmonid Passage at Stream Crossings, found in this manual in Appendix C, and Passage Criteria for All Aquatic Life Forms, in Chapter IX of the California Salmonid Stream Habitat Restoration Manual CDFG, 2002 and also found at <http://www.dfg.ca.gov/nafwb/pubs>.

DIAGRAM - CULVERT HYDRAULICS

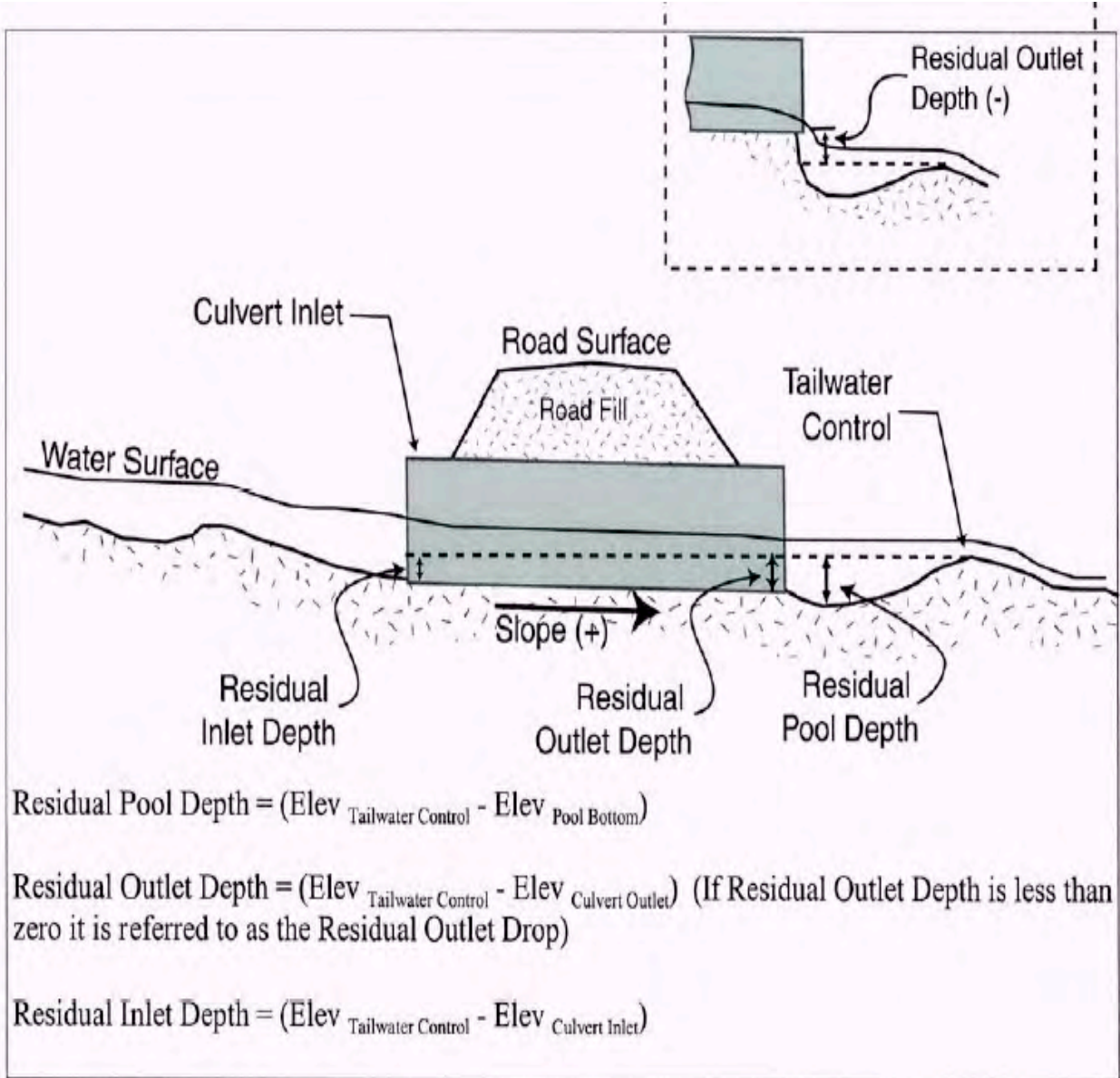

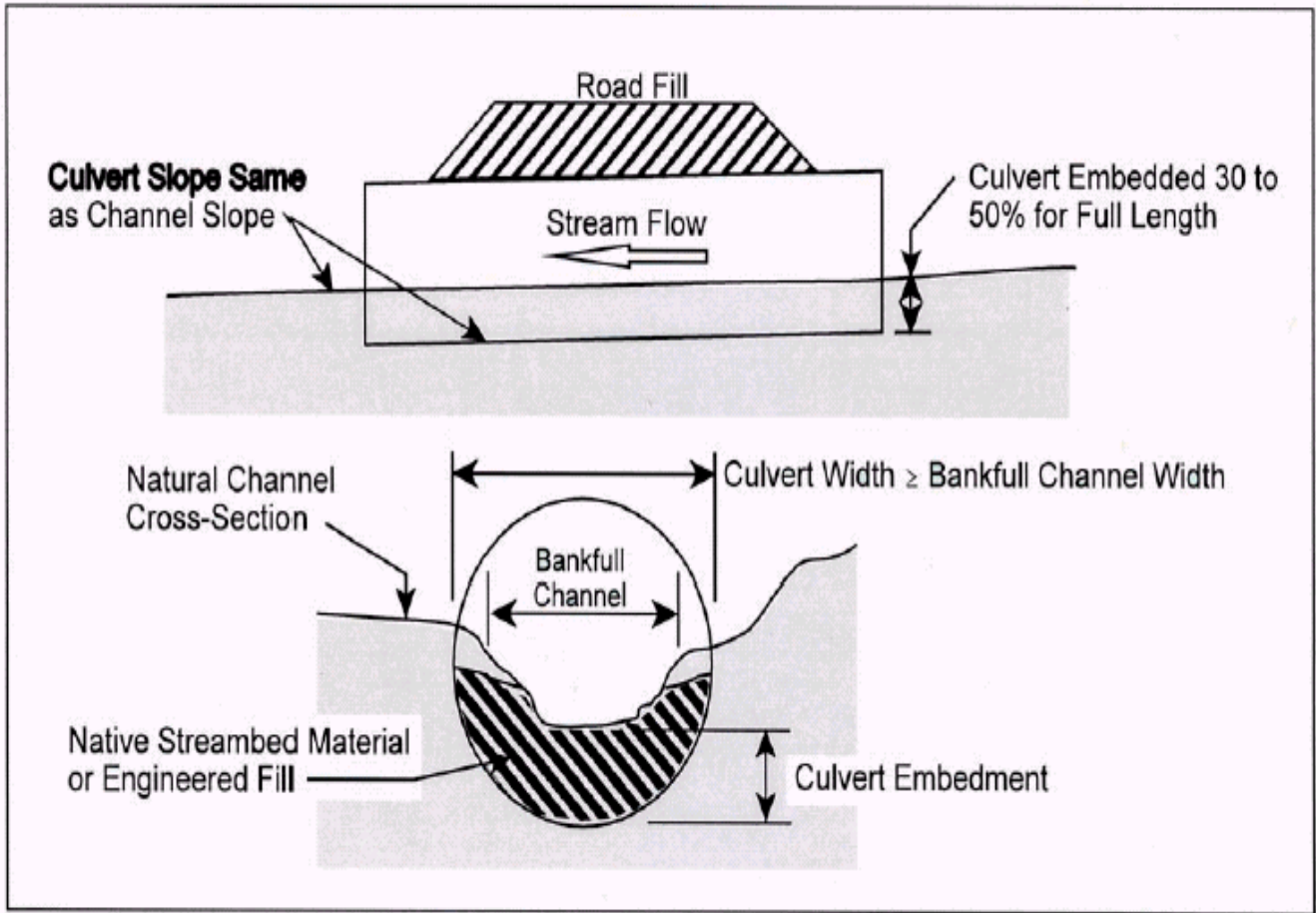

Stream simulation strategy option for installing culverts for fish passage. (DFG CA Salmonid Stream Habitat Restoration Manual. CH IX, 2002)

DIAGRAM - CULVERT PLUGGING

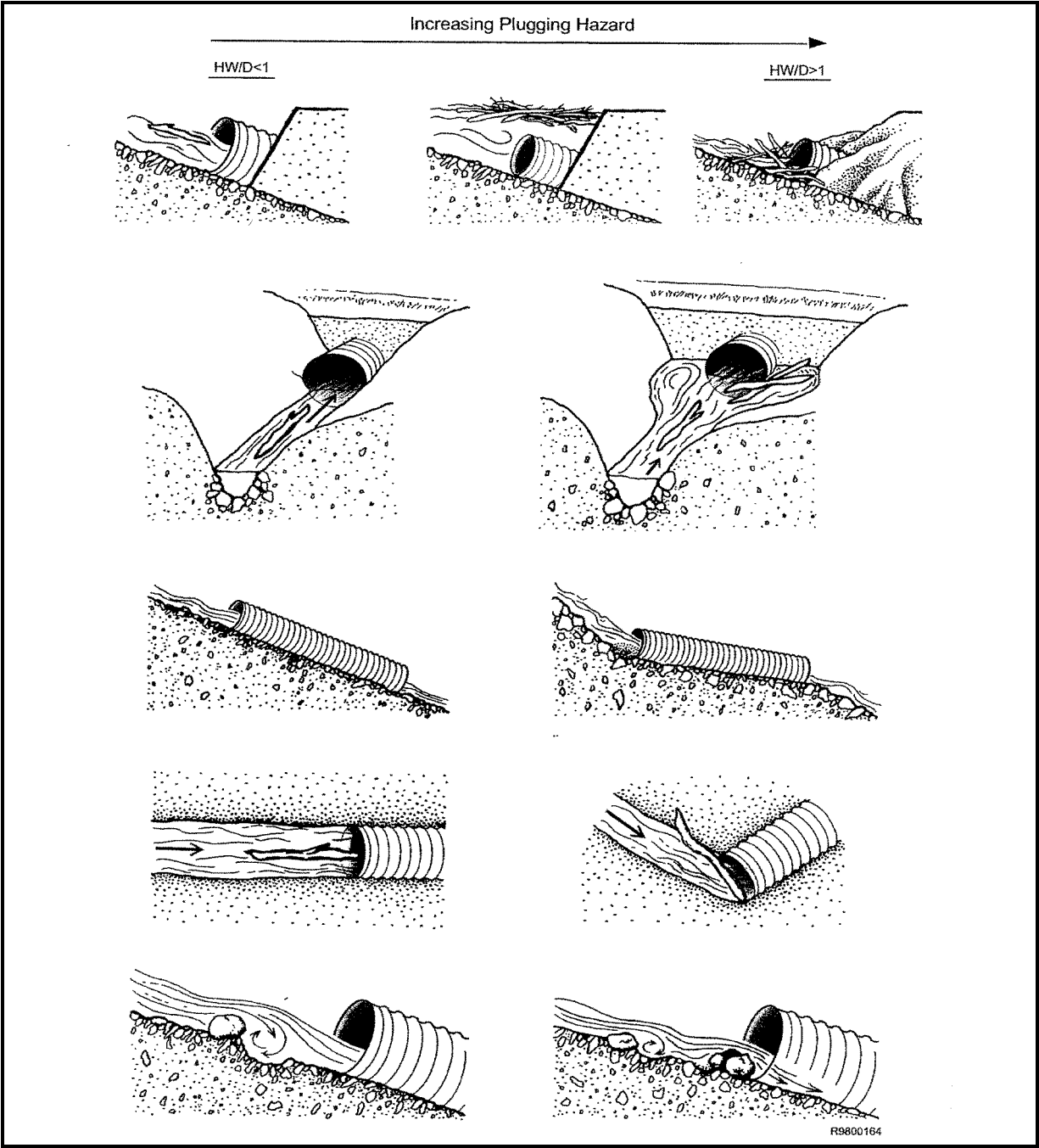

Source: USDA Forest Service (USFS). 2000. Water/Road Interaction Technology Series: “Diversion Potential at Road-Stream Crossings”, By M. Furniss et al., Technology and Development Program. San Dimas, CA.

BMP - CULVERT SIZING

DESCRIPTION

Current state and federal guidelines for new crossing installation aim to provide unimpeded passage for both adult and juvenile salmonids. Guidelines have also been developed for sizing culverts on non-fish bearing streams. For detailed specifications see Appendix C: NOAA Fisheries Guidelines for Salmonid Passage at Stream Crossings and Fish and Game Passage Criteria for All Aquatic Life Forms Chapter IX of the California Salmonid Stream Habitat Restoration Manual CDFG, 2002.

APPLICATIONS

Three design guidelines have been created by state and federal agencies for designing new and replacement culverts. The three methods are:

1. The Active Channel Design Method is a simplified design that is intended to size a culvert sufficiently large and embedded enough into the channel to allow for natural movement of bedload and formation of a stable bed inside the culvert. Used for streams under 3% natural slope and for culverts less than 100 feet in length.
2. The Stream Simulation Design Method is a design process that is intended to mimic the natural stream processes within a culvert. Fish passage, sediment transport, flood and debris conveyance with the culvert are intended to function as they would in a natural channel. Stream simulation culverts require a greater level of information on hydrology and geomorphology (topography of the stream channel) and a higher level of engineering expertise than Active Channel Design Method.
3. The Hydraulic Design Method is a design process that matches the hydraulic performance of a culvert with swimming abilities of a target species and age class of fish. Determination of high and low flow fish passage design flows, water velocity, and water depth are required for this method.

LIMITATIONS

- ✓ It is the responsibility of the project sponsor to obtain the most current version of the culvert criteria for fish passage. Copies of the current criteria are available from the California Department of Fish and Game through the appropriate regional office.
- ✓ Obtain all applicable permits for modification of the bed or bank of a stream.
- ✓ Culvert installation can generate sediment so erosion and sediment control measures need to be implemented.
- ✓ All culverts are prone to failure. Examine alternatives to culverts such as bridges and wet crossings.

CONSTRUCTION GUIDELINES

- 1) Choose the appropriate method from the three sketches presented.
- 3) All culverts should be designed to pass the 100-year storm at less than 100% of the culverts height. This allows for passage of woody debris during extreme high flows. The size of the culvert as determined by methods 1, 2, or 3 should be checked to pass the 100-year storm. The 100-year storm flow can be determined by using the rational method, local stream gage data, or regional flood estimation equations. The culvert size should then be checked using a simple hydraulic program such as Culvert Master or Fish-Xing now available on-line.
- 4) Culvert width should be at least as wide as the active channel. This reduces constriction of flows at the inlet.
- 5) The culvert bottom should be buried below the streambed allowing for a natural bottom, creating a smooth entrance at the upstream and downstream end without excessive drops.
- 6) Minimize stream diversion potential by providing an outslope (see BMP - Outsloping) or dip (see BMP - Critical Dip) in the road grade at the crossing so that when the culvert plugs, water passes over the road and returns to its original course without being diverted down the road or road ditch.
- 7) Place the culvert parallel to the natural channel so that the inlet will not plug, and flow from the outlet will not erode either of the channel banks.
- 8) Whenever possible, the road should cross at right angles to the stream channel.
- 9) Prevent discharge of soil and other pollutants into the watercourse. Prevention methods include: construction when there is no water in the stream (see BMP – Seasonal Planning), diverting the water around the construction site or installing a temporary dam (see BMP - Aqua Barrier), and installing other silt barrier and control BMPs.
- 10) Debris-free fill soil, preferably with some clay content, must be properly compacted in layers along the length of the pipe to prevent water piping on the outside of the culvert. See also BMP - Ditch Relief Culvert for installation details.
- 11) Fill slopes at the inlet and outlet should be armored with the appropriate size rock or well- vegetated with perennial vegetation. Fill slopes should be no steeper than 2:1 (H:V).
- 12) Maintain copies of permits on-site during construction.

BMP MAINTENANCE

- ✓ Culverts require a high degree of maintenance to prevent plugging. Trash racks for small culverts such as the Single-Post Trash Rack BMP may help to reduce plugging but still must be checked and cleaned before and during the rainy season.
- ✓ Check around the culvert for piping or by-passing. Plug any gaps.
- ✓ Maintain the integrity of fill-slope protection of both the inlet and outlet sides.
- ✓ Check culverts for rusted bottoms or joint separation.

BMP REMOVAL

- ✓ If the crossing is to be abandoned or cannot receive annual maintenance, remove the culvert and slope back the banks to the original grade. Seed and mulch all bare soil areas with the appropriate weed free seed and mulch. Dispose of fill in an upland stable location, and stabilize with seed and mulch.

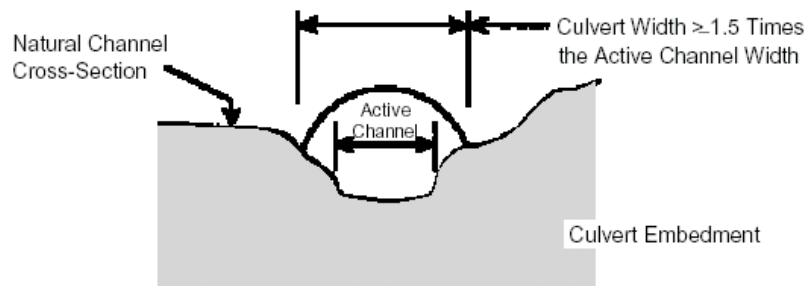
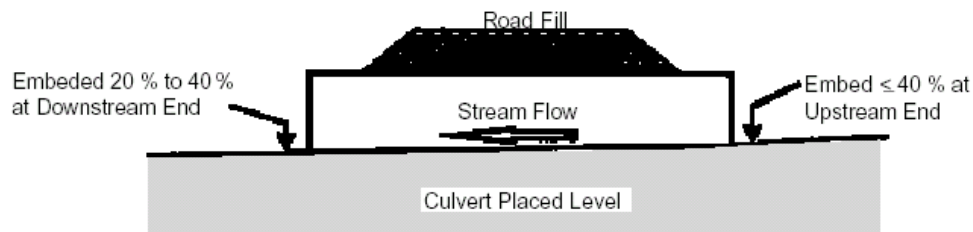

Active Channel Design Option :

- New and replacement culvert installations
- Simple installations on very small streams with channel slopes less than 3 %
- Short culvert length (less than 100 feet)
- Passage required for all fish

Choose a culvert size 1.5 times the width of the active channel. The active channel is that width indicated by the end of perennial vegetation and bed materials scoured a several storm events per year. Install the culvert at 0% or less slope. Embed the culvert so that the downstream end is 20 % to 40% embedded, and the upstream end is equal to or less than 40 % embedded.

Source:
California Fish Passage Workshop 2001

CULVERT SIZING
OPTION #1

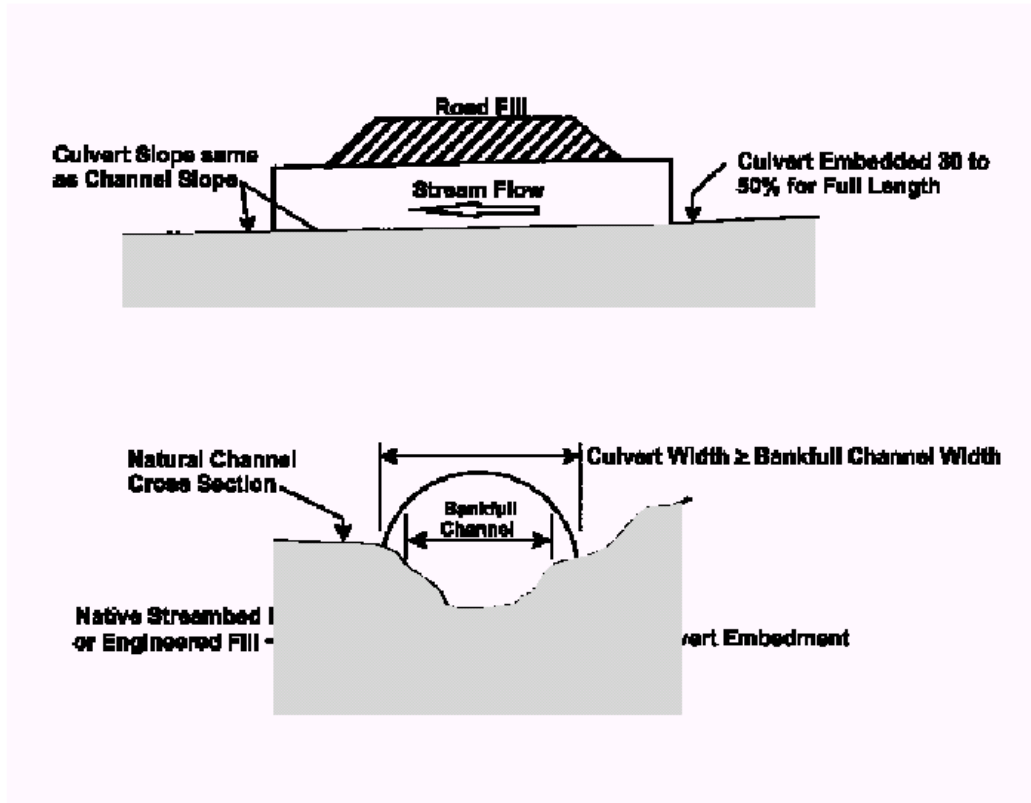

Stream Simulation Design Option:

- New and replacement culvert installations
- Minimum Culvert width = 6 feet
- Simple installations with channel slopes less than 6 %
- Moderate to long culvert length (greater than 100 feet)
- Passage required for all fish
- Ecological connectivity required

Need topographic survey, hydrology, channel forming discharge geometry. See Sept. 2000 Army Corps waterways experiment station report "Channel Forming Discharge"

See California Department of Fish & Game, 2002. California Salmonid Stream Habitat Restoration Manual, chapter IX.

Source:
California Fish Passage Workshop 2001

CULVERT SIZING
OPTION #2

Fish passage can be computed by Roads Engineers by using Fish Xing Software for culvert design and assessment, found at <http://www.fs.fed.us.fishxing/>

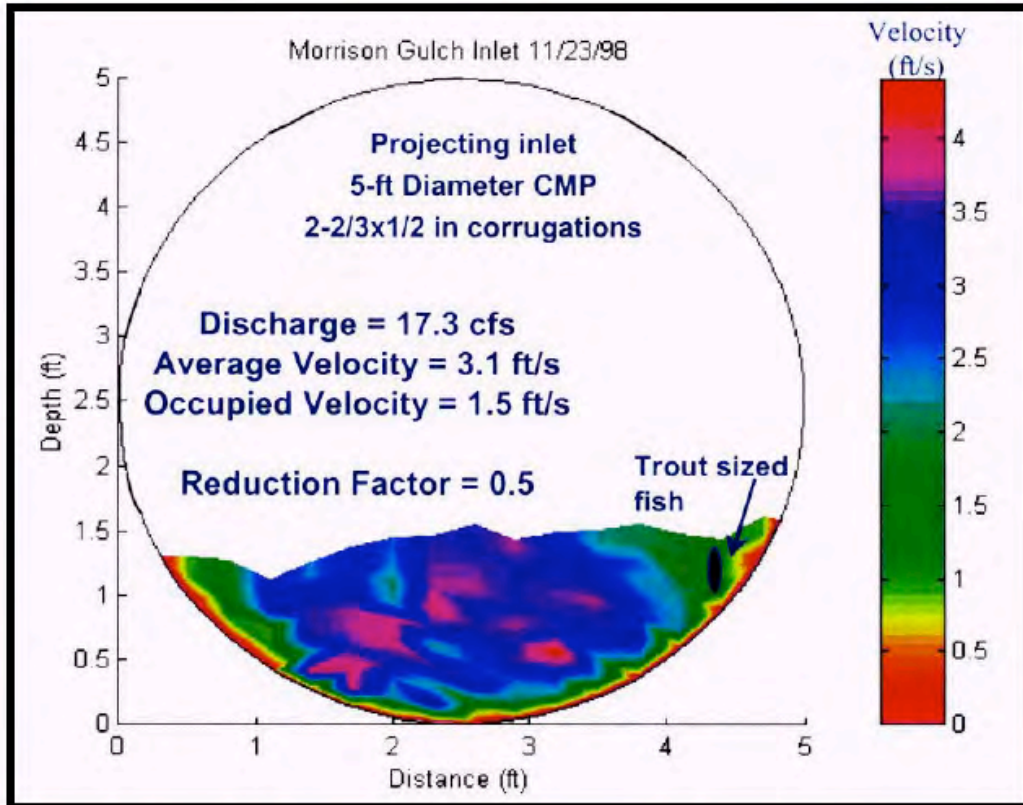

On Quarry Road at Morrison Gulch, tributary to Jacoby Creek, Humboldt Bay watershed.

Hydraulic Design Option :

- New, replacement, and retrofit culvert installations
- Minimum Culvert width = 3 feet
- Low to moderate channel slopes less than 3 %
- Active Channel Design or Stream Simulation Option is not physically feasible
- Swimming ability and behavior of target species of fish is known
- Ecological connectivity not required
- Evaluation of proposed improvements to existing culverts

Detailed design matching hydraulic performance of culvert with swimming ability of target species and age class of fish. High level of engineering expertise, hydrologic data analysis needed. Fish passage software for culvert design and assessment is available on the net at www.stream.fs.fed.us/fishxing/

Source:

California Fish Passage Workshop 2001

CULVERT SIZING
OPTION #3

BMP - CULVERT INLET SEDIMENT TRAP

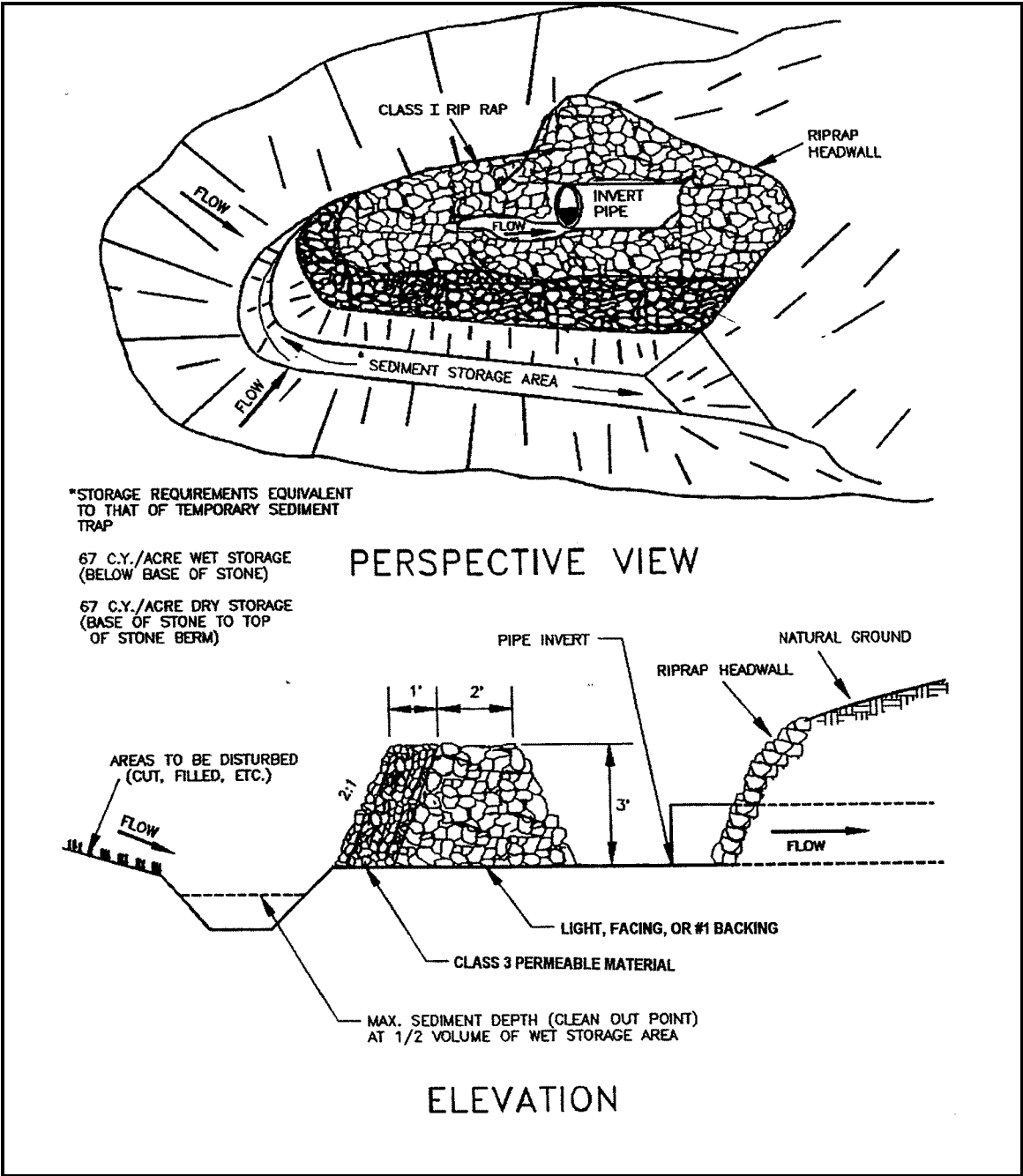

Source: Association of Bay Area Governments (ABAG). 1995. Manual of Standards for Erosion & Sediment Control Measures. 2nd edition. Oakland CA.

BMP- TRASH RACK- SINGLE POST

DESCRIPTION

A single-post trash rack is placed upstream of a culvert in small streams to turn floating branches and debris along the direction of flow so that they will pass through the culvert.

APPLICATIONS

A trash rack can be used in small drainages when woody debris may contribute to the failure of a culvert by hanging up across the culvert opening.

LIMITATIONS

- ✓ Trash racks require frequent maintenance to remain effective.
- ✓ Larger debris may hang up on the post and create an upstream blockage. Depending on channel entrenchment, debris could cause water to bypass the culvert.
- ✓ Culverts must be sized for the 100-year storm or larger when using the single post trash rack in order to pass debris.
- ✓ Culverts and trash racks must be constructed with other fall-back measures such as a critical dip in the road (see BMP-Critical Dip) to take overflow and fill slope protection with rock armoring.

CONSTRUCTION GUIDELINES

- 1) A galvanized steel post with a diameter $1/12^{\text{th}}$ the diameter of the culvert is installed upstream of the culvert.
- 2) The post is driven into the ground centered at a distance upstream equal to the diameter of the culvert. Example: a 3 foot diameter culvert would have a post placed 3 feet upstream from the culvert inlet in the center of the channel.
- 3) $2/3^{\text{rd}}$ of the post length must be secured into the ground to be kept in place.

BMP MAINTENANCE

- ✓ Trash racks must be checked on a regular basis and cleared after storm events to prevent the complete failure of the culvert.

BMP REMOVAL N/A

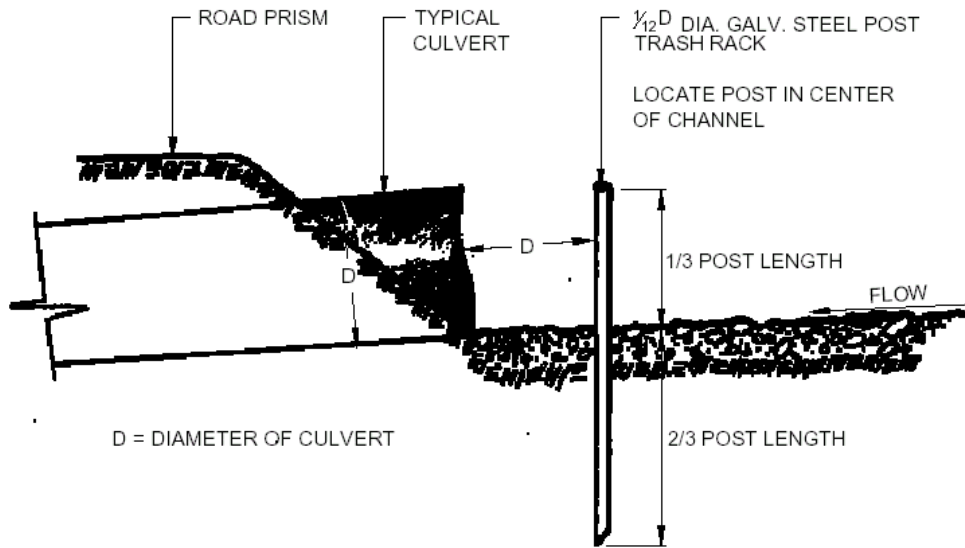

NOTE: THIS DESIGN KNOCKS BRANCHES AROUND POST TO PASS THROUGH CULVERT. FOR SMALL STREAMS ONLY.

Source:
 ©Prunuske Chatham, Inc.
 Occidental, CA

**TRASH RACK:
 SINGLE POST**

BMP - ENERGY DISSIPATER

DESCRIPTION

An energy dissipater is a structure designed to control erosion at the outlet of a culvert or conduit by reducing the velocity of flow and dissipating the energy.

APPLICATIONS

This BMP is required at the outlet of any new or replacement drainage culvert. The outlets of channels, conduits, and other structures are points of high erosion potential. To prevent scour and undermining, an outlet stabilization structure is needed to absorb the impact of the flow and reduce the velocity to non-erosive levels. Evaluate existing culverts and schedule upgrades of energy dissipater installations as appropriate.

A riprap-lined apron is a commonly used practice for this purpose because of its relatively low cost and ease of installation. Extend the riprap apron downstream until stable conditions are reached, even though this may exceed the length calculated for design velocity control. Down drains may also be used as energy dissipaters. Rock aprons may also be required below down drains depending on slope steepness and soil conditions.

LIMITATIONS

- ✓ Do not use this BMP below the mean high water line of any water body before obtaining appropriate permits. Due to issues relative to Corps 404 jurisdiction sometimes energy dissipaters are not placed below the ordinary high water mark which results in increased erosion
- ✓ Consider other energy dissipaters such as concrete impact basins, paved outlet structures, or a half culvert where site conditions warrant.
- ✓ Rock/riprap dissipaters may require containment in mattresses to maintain their effectiveness.

CONSTRUCTION GUIDELINES

- 1) Adequately compact berm material to prevent failure.
- 2) Apply temporary seeding and mulch to all surfaces of a soil diversion berm according to the BMP-Seasonal Planning.

BMP MAINTENANCE

- ✓ After heavy rains, inspect outlet structures for erosion or dislodged stones. Immediately make all needed repairs to prevent further damage.

BMP REMOVAL

- ✓ BMP removal should not be necessary.

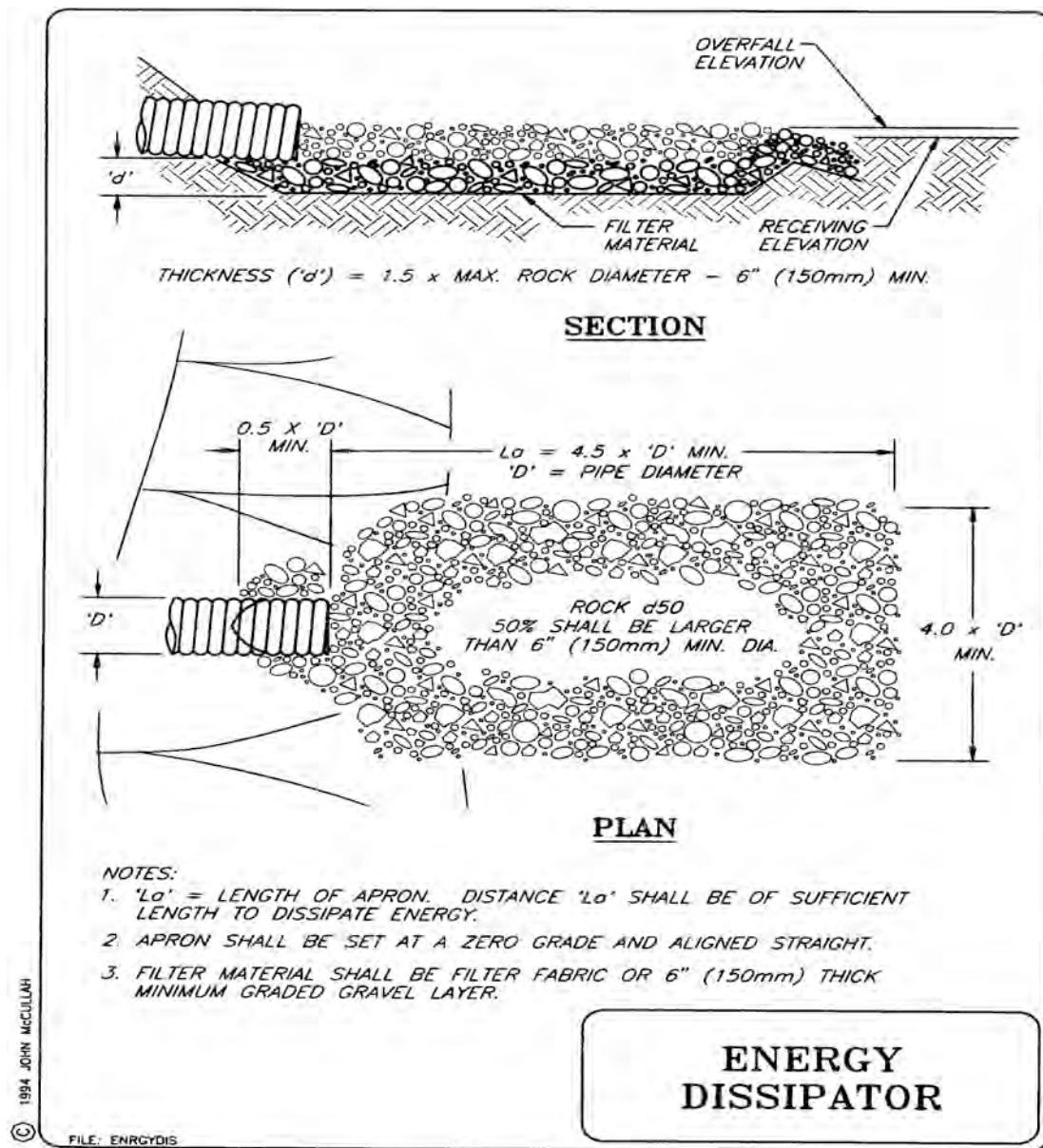

BMP - BACK-FLOODING WEIRS

APPLICATIONS

This BMP should be used when a culvert is *not* installed with at least 1/4 of its diameter at or below stream grade. The purpose is to help pass adult and juvenile fish where a jump barrier was created by scour at the downstream end of culverts.

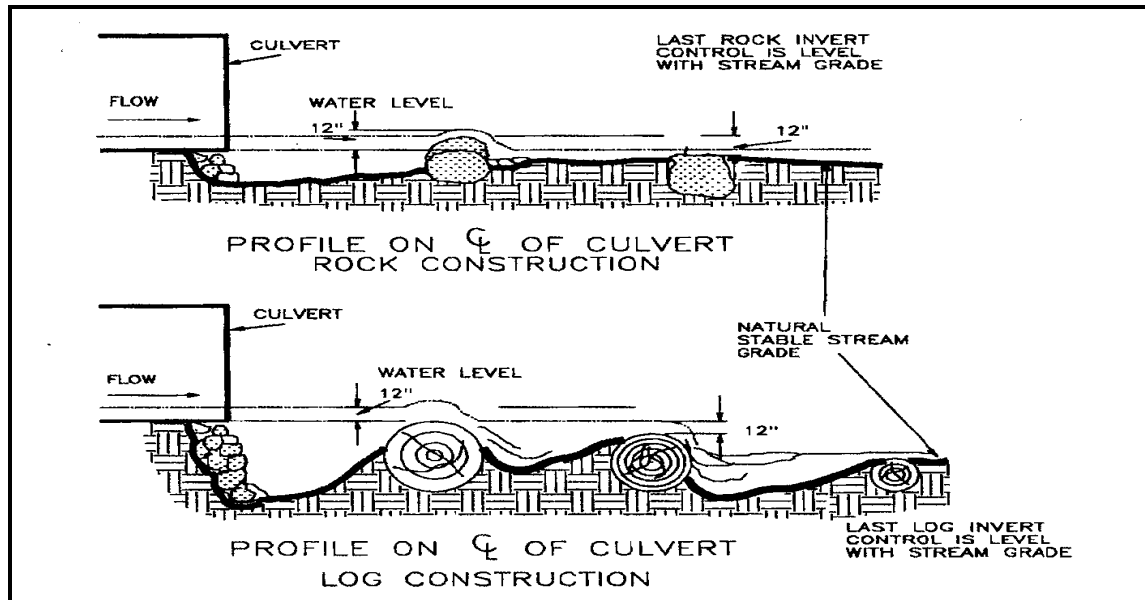

Source: California Dept. of Fish and Game (CDFG). 1998. California Salmonid Stream Habitat Restoration Manual. By Gary Flosi, et al. Inland Fisheries Div., 3rd edition.

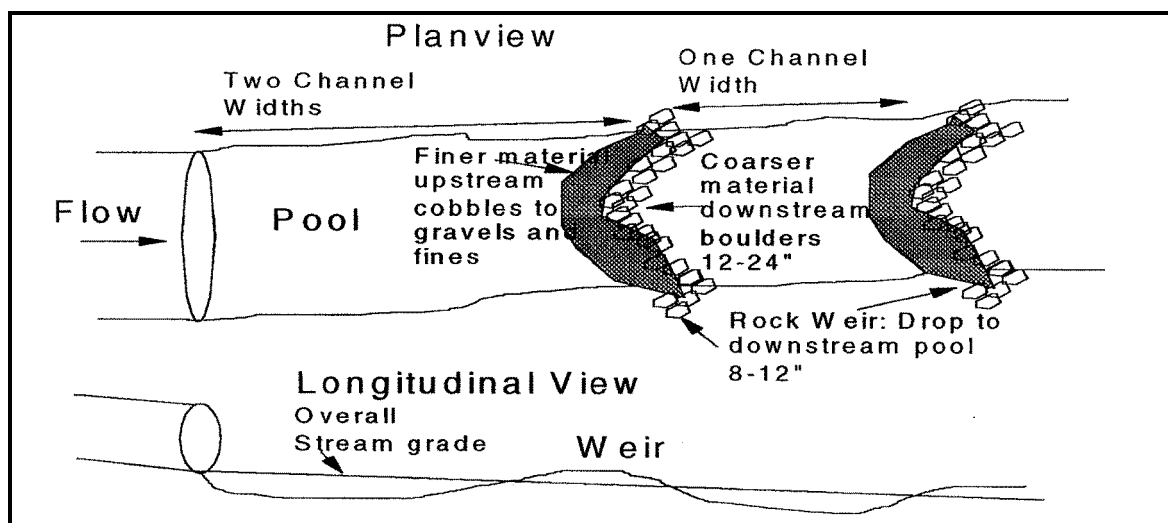

Source: Robison, E., A. Mirati, and M. Allen. 1999. Oregon Road/Stream Crossing Restoration Guide. Advanced Fish Passage Training Version. Salem OR.

BMP- BAFFLES FOR FISH PASSAGE

DESCRIPTION

Baffles are added to a culvert to increase the hydraulic roughness of the culvert and therefore reduce the average cross-section velocity. The purpose is to improve fish passage, mainly for adults.

Note: In general, we *do not* recommend baffled culverts except as a last resort. In many cases the culvert should simply be removed.

APPLICATIONS

To provide for adult fish passage in an existing culvert in a low gradient stream with good habitat upstream, and where funding is not available to replace with a bridge or open bottomed culvert. Cost and maintenance usually make this choice a last resort.

LIMITATIONS

Again, this BMP is usually a last resort, for reasons including:

- ✓ Baffles within a culvert are not a desired solution to meeting velocity criteria and are not appropriate for new culvert installations.
- ✓ Baffles should not be installed in culverts with less than 5 feet of headroom or in high gradient streams (>3.5% slope) with large bedload and debris moving through.
- ✓ Culverts with baffles are more prone to clog with debris and sediment. Baffles can rip out and damage the culvert or cause it to fail.
- ✓ Cost of maintenance is high.
- ✓ Permit process is longer and more difficult than for other solutions, thereby requiring more advance planning

CONSTRUCTION GUIDELINES

- 13) The figure below depicts two baffle styles for round culverts and one for box culverts. They are all designed with a continuous alignment of notches along one wall rather than alternating back and forth. This design allows less resistance to high flows and an uninterrupted line of fish passage along one or both sides. This feature is particularly important for weak fish which would be forced to cross the high velocity zone at every baffle in an alternating baffle design.
- 14) Two details of angled baffles are shown for box culverts; the continuously sloped baffle is generally used for juvenile passage situations and in culverts 6 feet wide and less. The notch baffle style is especially useful in large culverts and can be

applied to slopes of 2.5-3.5%. Corner baffles generally apply to culverts with slopes from 1.0-2.5%.

- 15) To avoid reducing the culvert capacity, the upstream baffle should be placed at least one culvert diameter downstream of the inlet and should be high enough to ensure subcritical flow at the inlet at the high design flow. A modification of the culvert, such as a mitered end or wingwalls, may also be required to improve its hydraulic efficiency.

Baffles for Round and Box Culverts

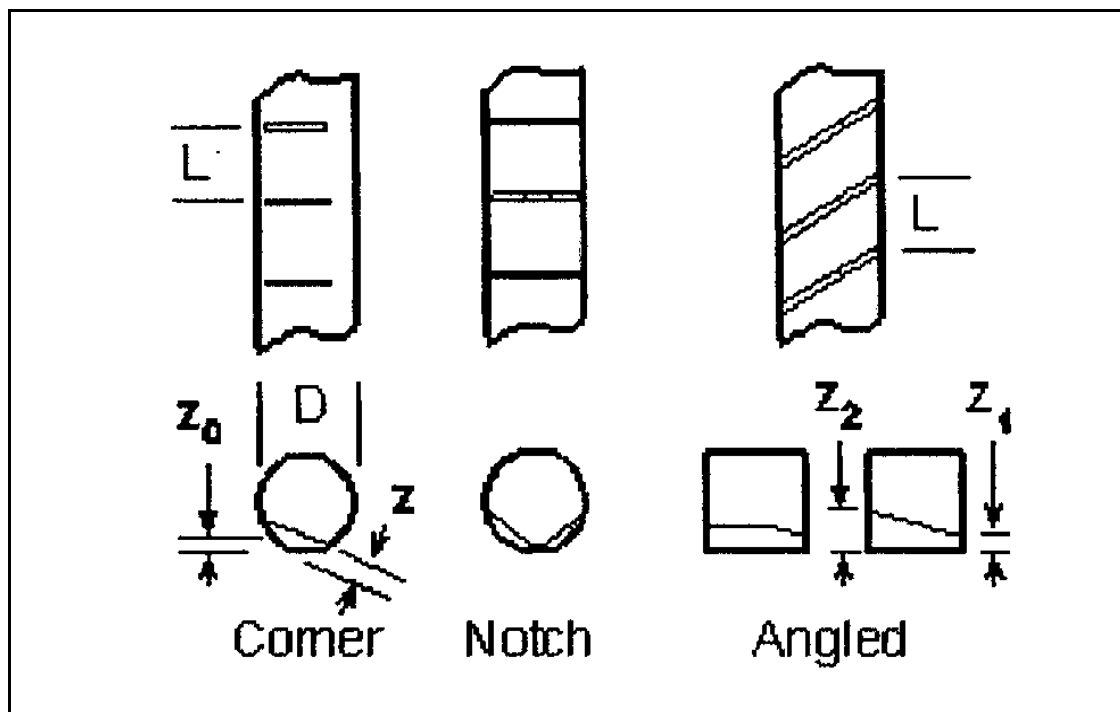

Source: Washington Dept. of Fish and Wildlife. 1999. Fish Passage Design at Road Culverts: A design manual for fish passage at road crossings. Olympia WA.

Washington Baffles with Separator Wall

(for culverts > 7 ft. width)

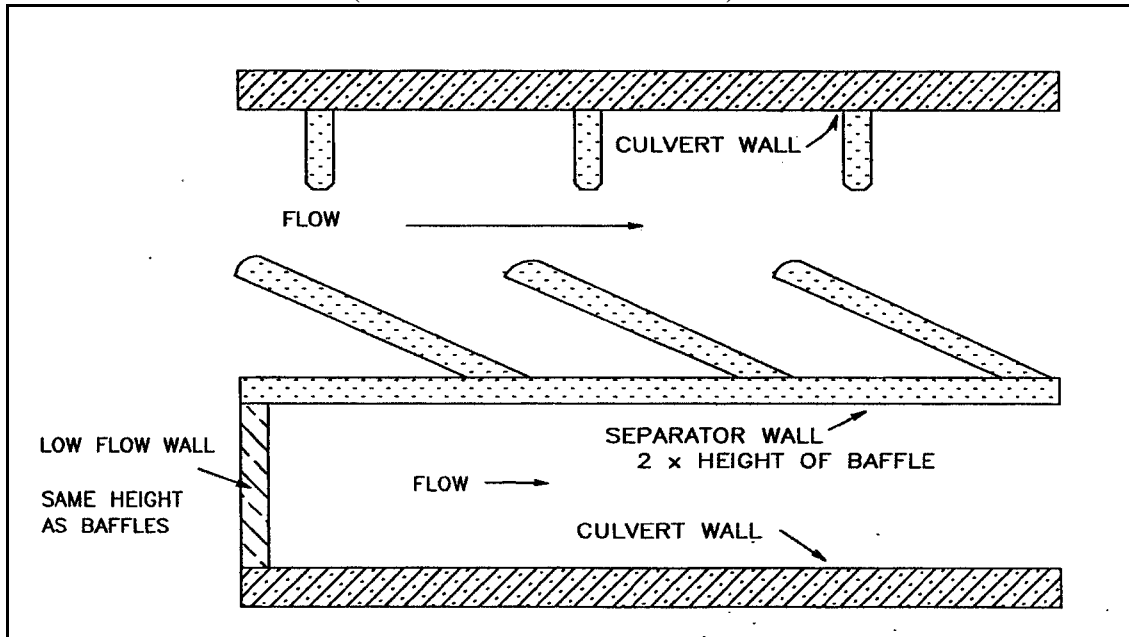

Source: CDFG, 1998

Washington Baffles

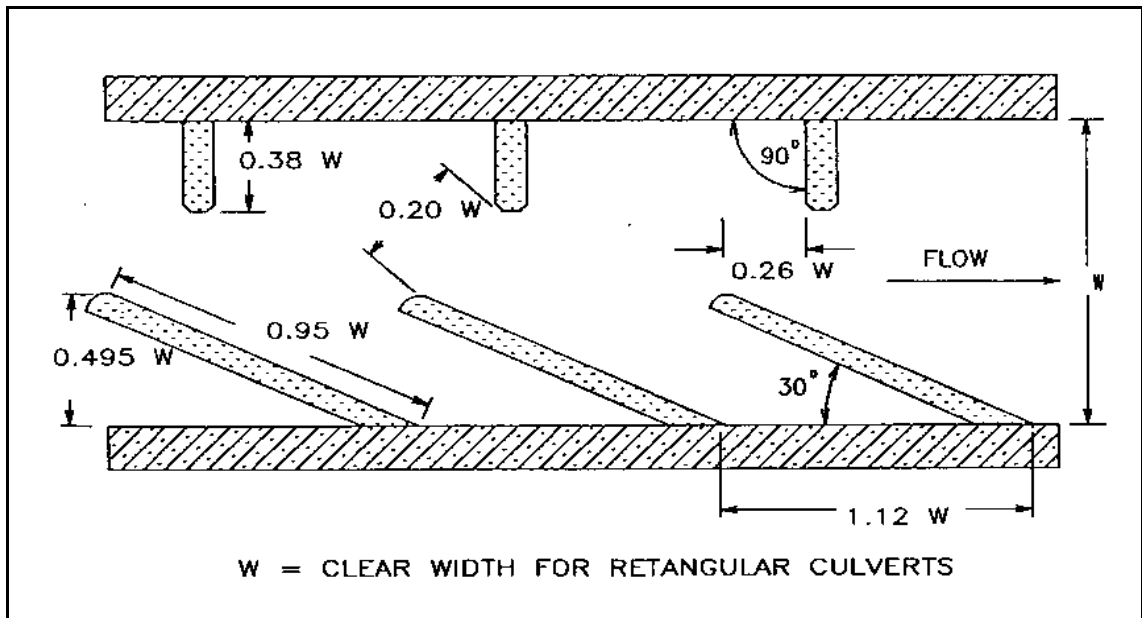

Source: CDFG, 1998

Redwood Washington Baffle Construction

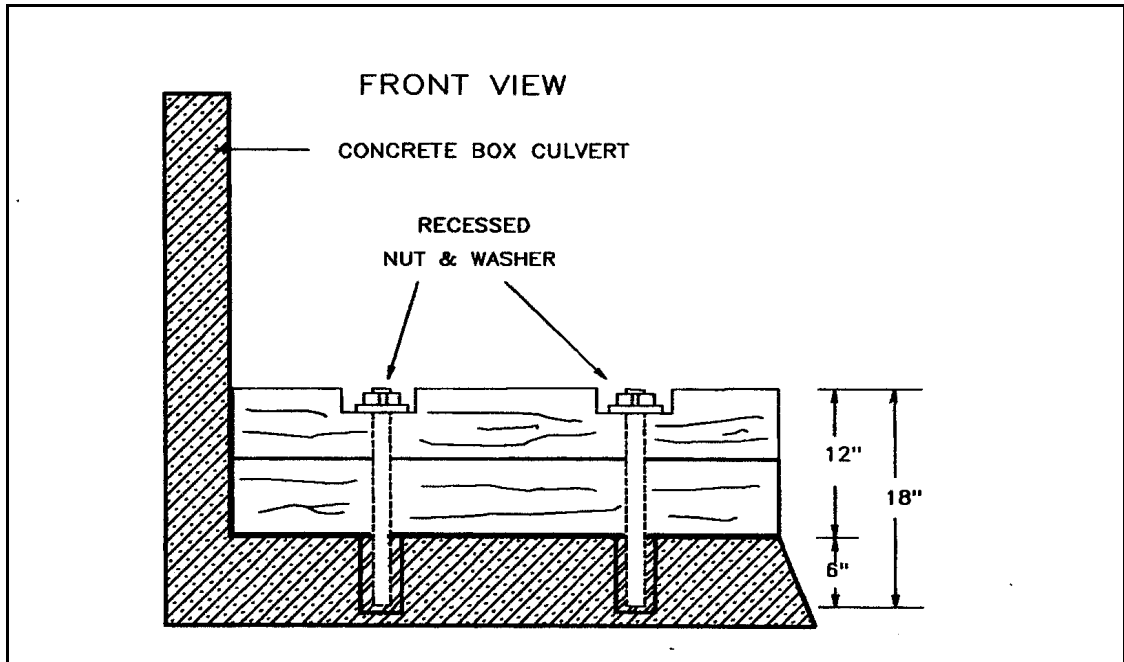

Source: CDFG, 1998

Steel Washington Baffle

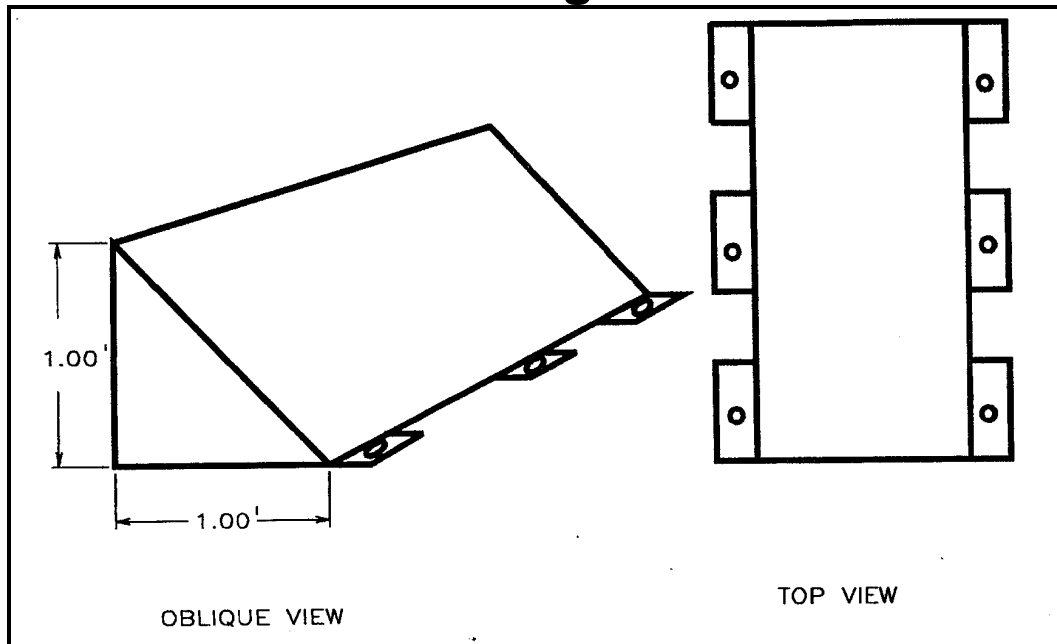

Source: CDFG, 1998

EROSION CONTROL BMPs

□	BLANKETS/GEOTEXTILE FABRICS	A- 53
□	COIR FABRIC-NETTING.....	A- 61
□	COIR LOGS/STRAW ROLLS.....	A- 63
□	BROADCAST SEEDING.....	A-67
□	HYDROSEEDING.....	A-69
□	MULCHING.....	A- 71
□	PLANTING	A- 73
□	SURFACE ROUGHENING & SOIL TRACKING	A-77
□	STEPPED OR TERRACED SLOPE	A-82
□	PLASTIC COVERING	A- 83
□	ROCK BREAST WALL.....	A-85
□	VEGETATED GEOBERM TOE WALL.....	A-87

BMP – BLANKETS/GEOTEXTILE FABRICS

DESCRIPTION

Erosion control blankets and mats are installed to protect the prepared soil surface of a steep slope.

APPLICATIONS

Erosion control blankets are used on steep slopes to temporarily stabilize and protect disturbed soil from raindrop impact and surface erosion, to increase infiltration, decrease compaction and soil crusting, and to conserve soil moisture. Erosion control blankets also protect seeds from predators, reduce desiccation and evaporation by insulating the soil and seed environment. Some types of erosion control blankets and turf reinforcement mats are specifically designed to stabilize channelized flow areas.

LIMITATIONS

- ✓ This BMP should not be used in areas subject to scour from high flows (e.g. streambanks) unless designed by an engineer. Permits shall be obtained prior to any streambank or shoreline installation.
- ✓ Blankets and mats manufactured with plastic netting shall be avoided.

CONSTRUCTION GUIDELINES

- 1) Proper site preparation is essential to ensure complete contact of the protection matting with the soil.
- 2) Grade and shape area of installation.
- 3) Remove all rocks, clods, and vegetative or other obstructions so that the installed blankets, or mats will have direct contact with the soil.
- 4) Prepare seedbed by loosening 2-3 inches (50-75 mm) of topsoil above final grade.
- 5) Seed area before blanket installation for erosion control and re-vegetation. (Seeding after mat installation is often specified for turf reinforcement application.)
- 6) U-shaped wire staples, metal geotextile stake pins, or triangular wooden stakes can be used to anchor mats to the ground surface. Wire staples should be a minimum of 11 gauge. Metal stake pins should be 3/16-inch diameter steel with a

1 1/2 inch steel washer at the head of the pin. Wire staples and metal stakes should be driven flush to the soil surface. All anchors should be 6-8 inches long and have sufficient ground penetration to resist pullout. Longer anchors may be required for loose soils.

Installation on Slopes:

- 1) Begin at the top of the slope and anchor its blanket in a 6 inch deep x 6-inch wide trench. Backfill trench and tamp earth firmly.
- 2) Unroll blanket downslope in the direction of the water flow.
- 3) The edges of adjacent parallel rolls must be overlapped 2-3 inches and be stapled every 3 feet.
- 4) When blankets must be spliced, place blankets end over end (shingle style) with 6-inch overlap. Staple through overlapped area, approximately 12 inches apart.
- 5) Lay blankets loosely and maintain direct contact with the soil - do not stretch.
- 6) Blankets shall be stapled sufficiently to anchor blanket and maintain contact with the soil. Staples shall be placed down the center and staggered with the staples placed along the edges. Steep slopes, 1:1 to 2:1, require 2 staples per square yard. Moderate slopes, 2:1 to 3:1, require 1-2 staples per square yard (1 staple 3' on center). Gentle slopes require 1 staple per square yard.

BMP MAINTENANCE

- ✓ All blankets and mats should be inspected periodically following installation.
- ✓ Inspect installation after significant rainstorms to check for erosion and undermining. Any failure should be repaired immediately.
- ✓ If washout or breakage occurs, re-install the material after repairing the damage to the slope or drainage way.

BMP REMOVAL

- ✓ BMP removal should not be necessary.

Placement of Biodegradable Blankets

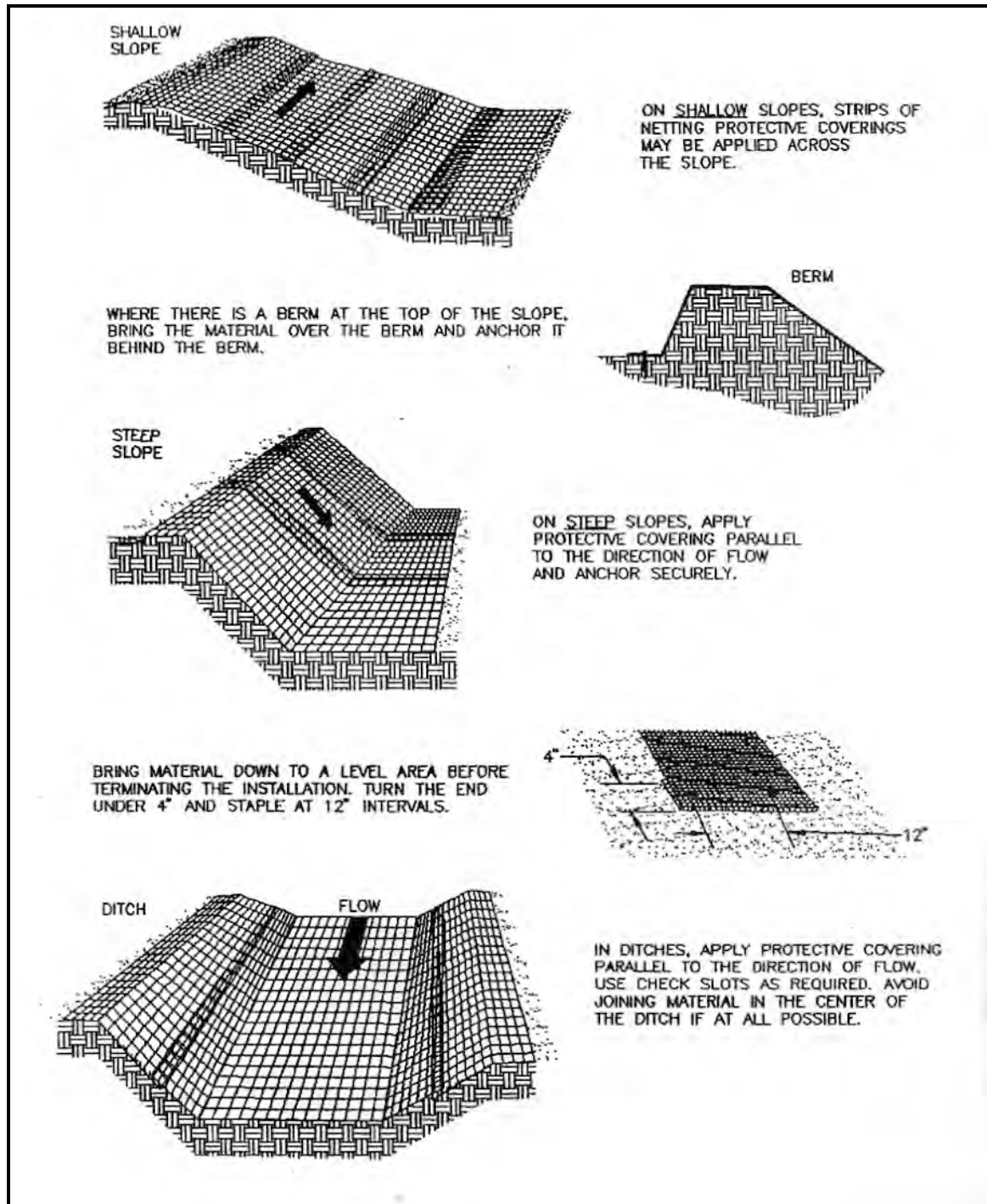

(Source: ABAG. 1995. Manual of Standards for Erosion & Sediment Control Measures. Oakland CA.)

Placement of Non-biodegradable Blankets

*** Important Note:** Non-biodegradable blankets should not be used in fish bearing streams and US Fish and Wildlife Service prohibits their use on stream crossings in the bankful channel.

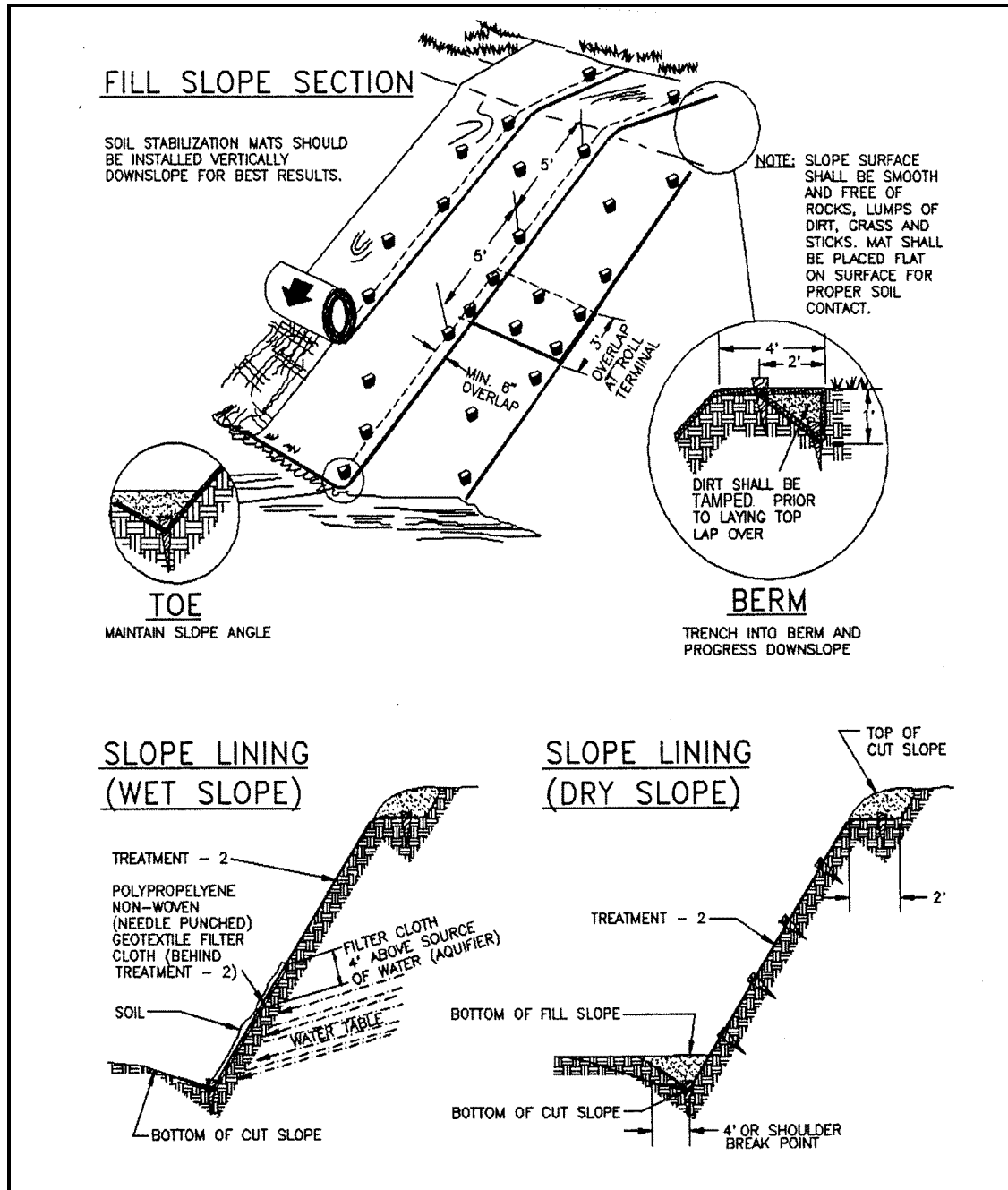

(Source: ABAG. 1995. Manual of Standards for Erosion & Sediment Control Measures. Oakland CA.)

Anchoring of Blankets

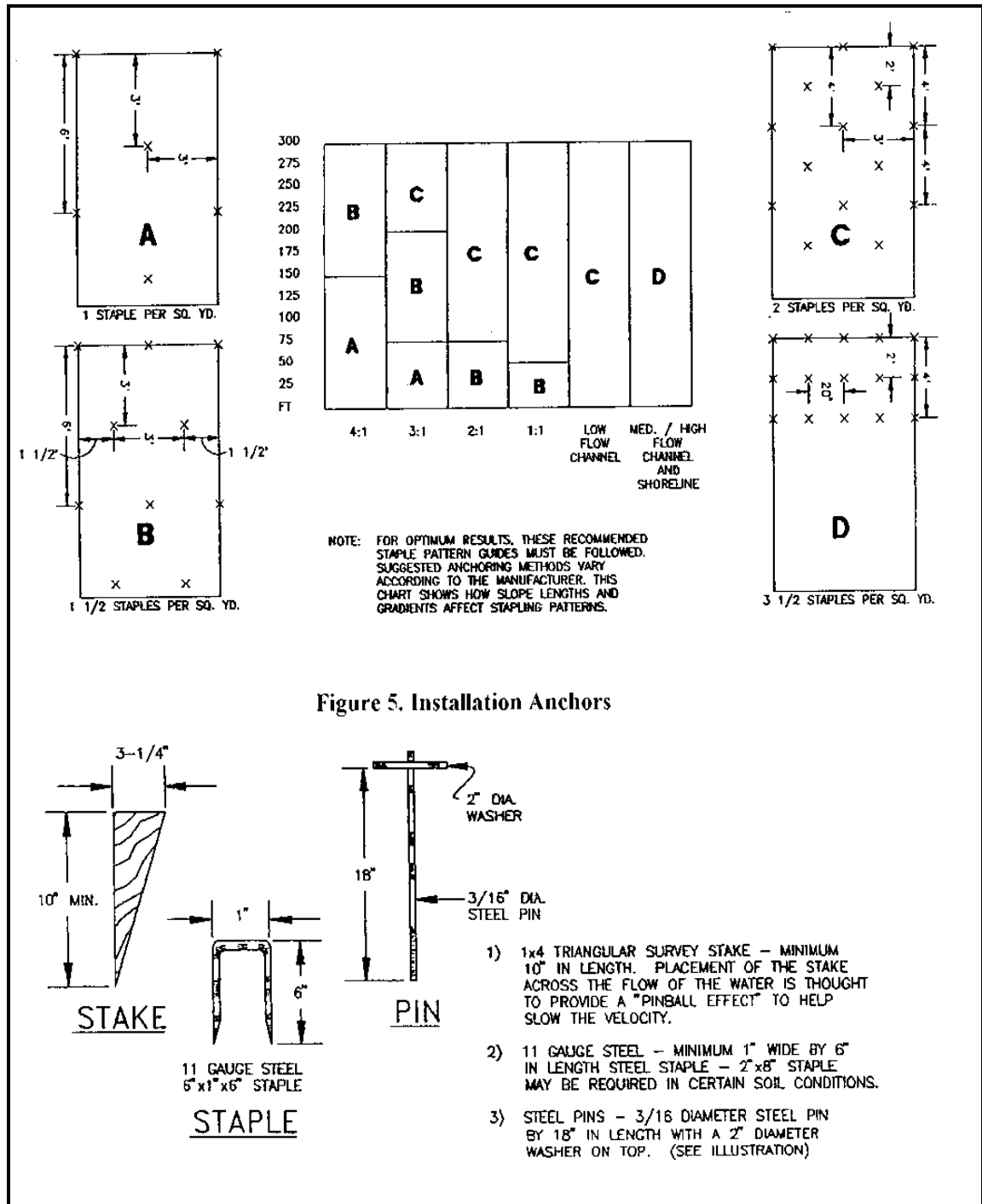

(Source: ABAG. 1995. Manual of Standards for Erosion & Sediment Control Measures. Oakland CA.)

MATS/BLANKETS SHOULD BE INSTALLED VERTICALLY DOWNSLOPE.

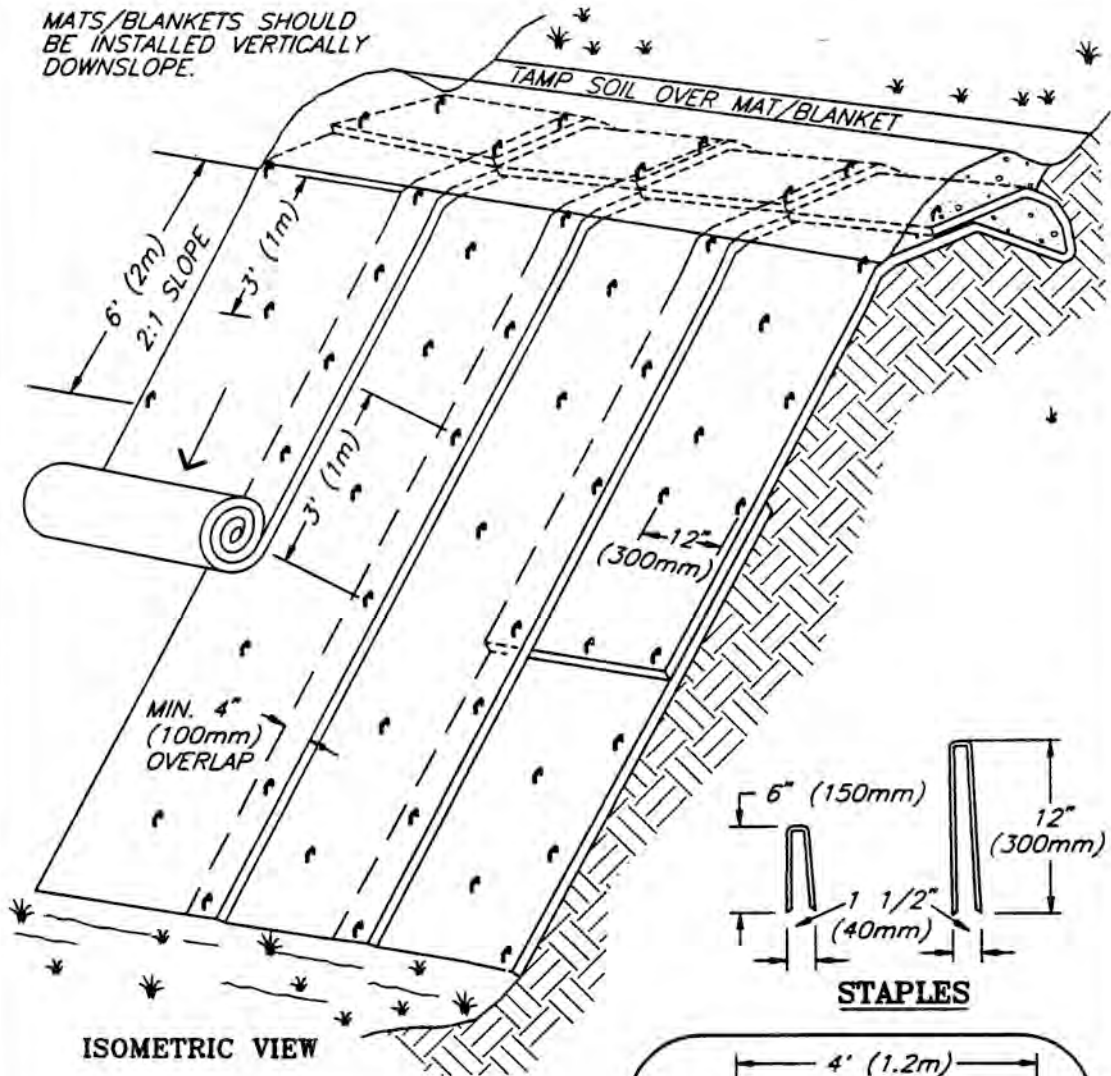

**TYPICAL SLOPE
SOIL STABILIZATION**

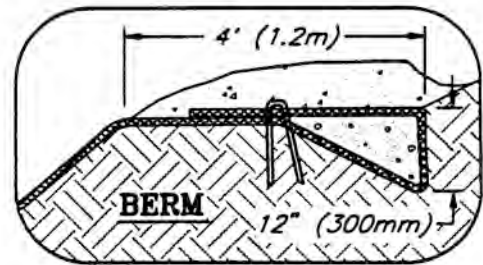
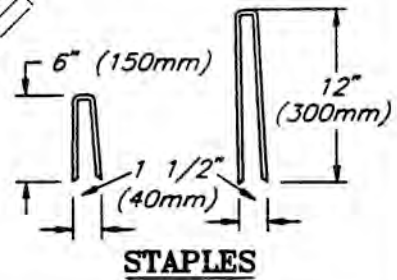

NOT TO SCALE

NOTES:

1. SLOPE SURFACE SHALL BE FREE OF ROCKS, CLODS, STICKS AND GRASS. MATS/BLANKETS SHALL HAVE GOOD SOIL CONTACT.
2. APPLY PERMANENT SEEDING BEFORE PLACING BLANKETS.
3. LAY BLANKETS LOOSELY AND STAKE OR STAPLE TO MAINTAIN DIRECT CONTACT WITH THE SOIL. DO NOT STRETCH.

**EROSION BLANKETS &
TURF REINFORCEMENT MATS
SLOPE INSTALLATION**

© 1994 JOHN McCULLAH

FILE: BLNKTSLP

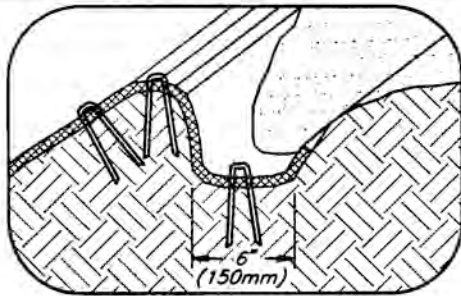

LONGITUDINAL ANCHOR TRENCH

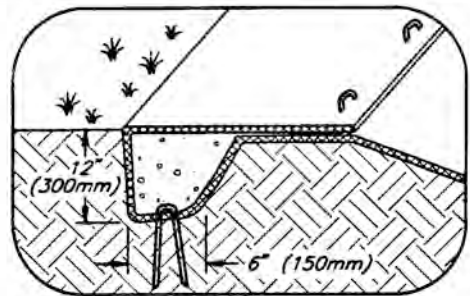

TERMINAL SLOPE AND CHANNEL ANCHOR TRENCH

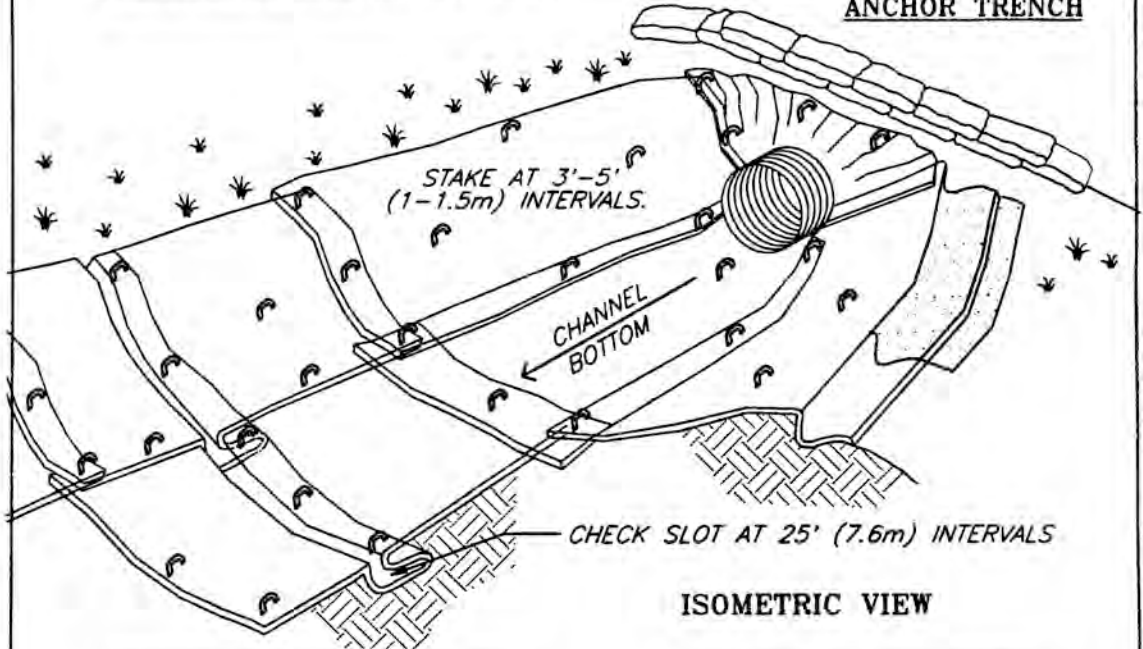

ISOMETRIC VIEW

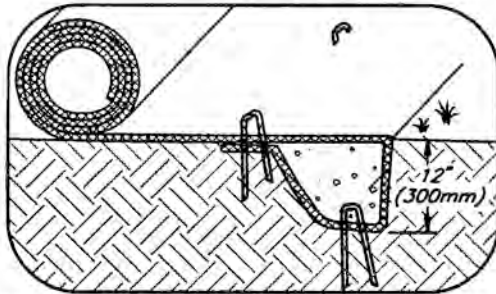

INITIAL CHANNEL ANCHOR TRENCH

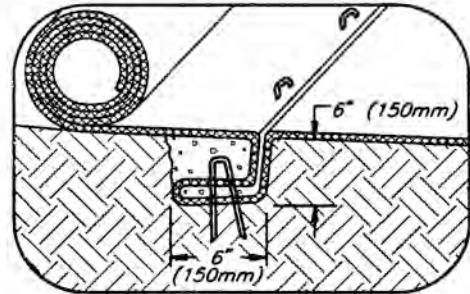

INTERMITTENT CHECK SLOT

NOTES:

1. CHECK SLOTS TO BE CONSTRUCTED PER MANUFACTURERS SPECIFICATIONS.
2. STAKING OR STAPLING LAYOUT PER MANUFACTURERS SPECIFICATIONS.

EROSION BLANKETS & TURF REINFORCEMENT MATS CHANNEL INSTALLATION

© 1994 JOHN McCULLAH
FILE: BLNKCHA

BMP - COIR FABRIC/NETTING

DESCRIPTION

Coir fabric/netting is a geo-textile product made from coconut fibers loosely woven into a fabric usually packaged in roll form. This fabric can be used to provide a reduction in water velocity/erosive forces and/or habitat protection and topsoil stabilization.

APPLICATIONS

This BMP may be used in areas to provide stabilization/protection to the soil surface of steep slopes or stream banks. It can be used in combination with vegetation and/or seeding to reinforce soil in high flow/high velocity waters and on slopes as steep as 1:1. It may be used as bank stabilization before vegetation efforts have occurred. Coir fabric or netting is preferred to jute. Jute fabrics are often treated with preservatives that will discourage the growth of vegetation. Jute will also degrade much more quickly than coir.

LIMITATIONS

This BMP should *not* be used:

- ✓ In the streambed.
- ✓ When short-term biodegradability is desired.

CONSTRUCTION GUIDELINES

- 1) When used near watercourses or streams, coir fabrics/nettings must be used in accordance with permit requirements.
- 2) Fabric may be laid out horizontally or vertically on slope.
- 3) Stakes or staples must be used to anchor fabric to ground.
- 4) Lay loosely on the surface so fabric makes contact with the ground (do not stretch for extra coverage).
- 5) Overlap fabric edges at least 12 inches.
- 6) The fabric should be trenched in at least 12 inches deep at the top and bottom ends of the installation to prevent undercutting.

- 7) If used in conjunction with hand seeding or hydroseeding, place seeding first and cover with fabric.
- 8) Live staking may be done after the fabric is placed by piercing the fabric.

BMP MAINTENANCE

- ✓ During construction, inspect daily during the workweek.
- ✓ Schedule additional inspections during storm events.
- ✓ Make any required repairs immediately.

BMP - COIR LOGS AND STRAW ROLLS

DESCRIPTION

Straw rolls are manufactured from straw wrapped in netting. Coir logs are similar, but are filled with coconut fiber rather than straw. The logs are placed and staked in shallow trenches along the contour of newly constructed or disturbed slopes. They can be used to provide perimeter protection, settling, reduction in water velocity/erosive forces and habitat protection.

APPLICATIONS

The BMP may be used for temporary soil stockpile protection, drop inlet protection, temporary check dams, bank or slope stabilization, and streambank toe protection. This BMP may be used for perimeter sediment control, and is preferred over silt fencing and straw bales. It may also be used to replace missing sections of earthen berms (example: above new ditch relief culverts). Straw rolls should be manufactured of rice straw or a sterile (non-seed bearing) straw to prevent the introduction of non-native grasses. Polypropylene or coir netting is preferred over plastic netting.

LIMITATIONS

This BMP should *not* be used:

- ✓ where flow volume or water velocity inhibit its usefulness.

CONSTRUCTION GUIDELINES

- 1) Logs are placed in 2 to 3 inch deep trenches and staked along the contours of newly constructed or disturbed slopes.
- 2) Log spacing depends on soil type and slope steepness.
- 3) Adjacent logs shall be tightly abutted to prevent water flow and gully formation between logs.
- 4) Ensure that logs are in contact with the ground in the trenches to prevent water flow under logs.
- 5) Live staking may be used in conjunction with logs.

BMP MAINTENANCE

- ✓ During construction, inspect daily during the workweek.
- ✓ Schedule additional inspections during storm events.
- ✓ Make any required repairs immediately.
- ✓ For perimeter control installations (securing spoils, etc.), remove sediment deposits when they reach ½ the height of the log/roll.

BMP REMOVAL

- ✓ Remove sediment buildup in front of BMP.
- ✓ Revegetation of the site may be necessary.
- ✓ Dispose of netting properly. Straw or coir filling may be used as mulch.
- ✓ BMP removal may not be necessary.

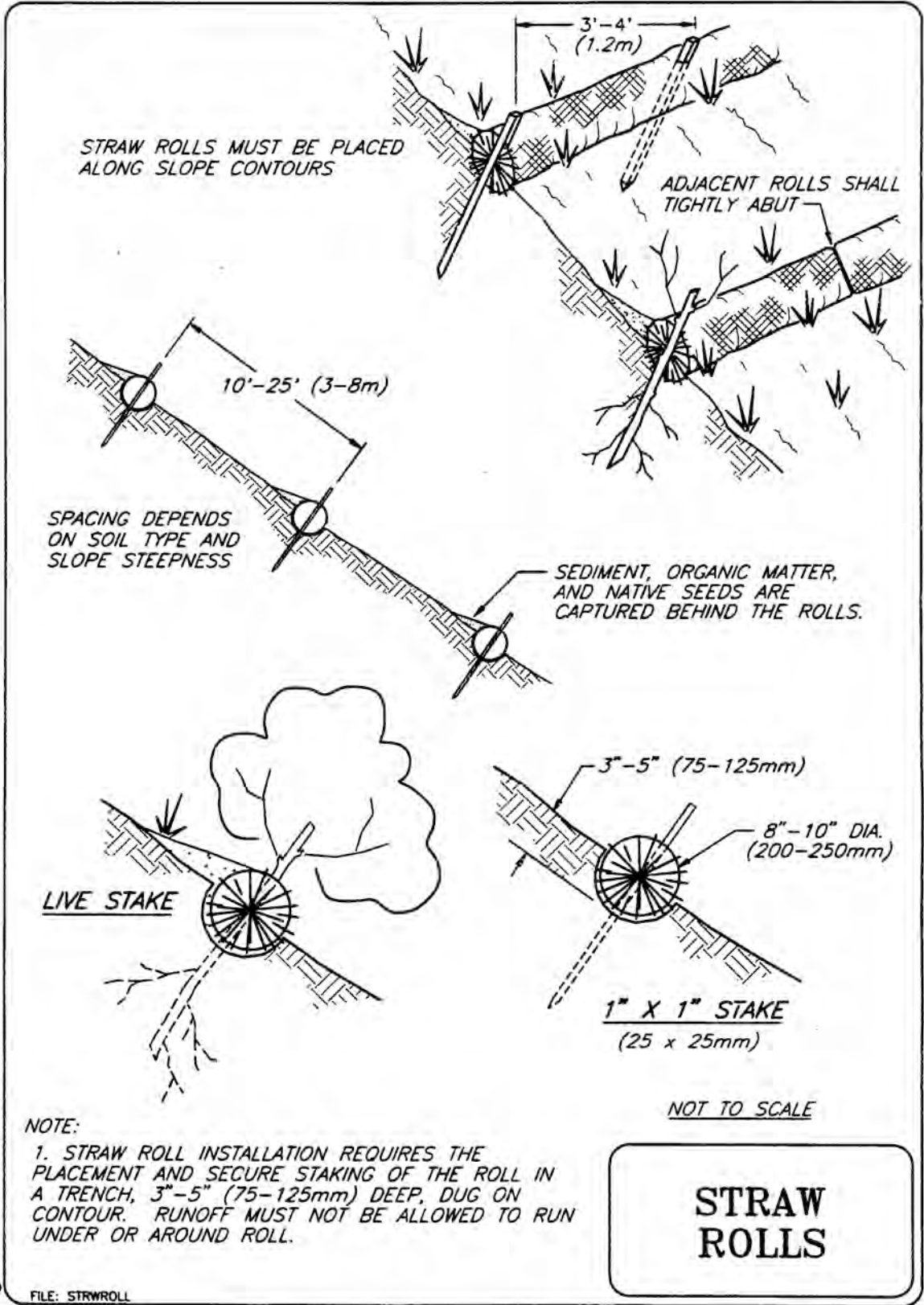

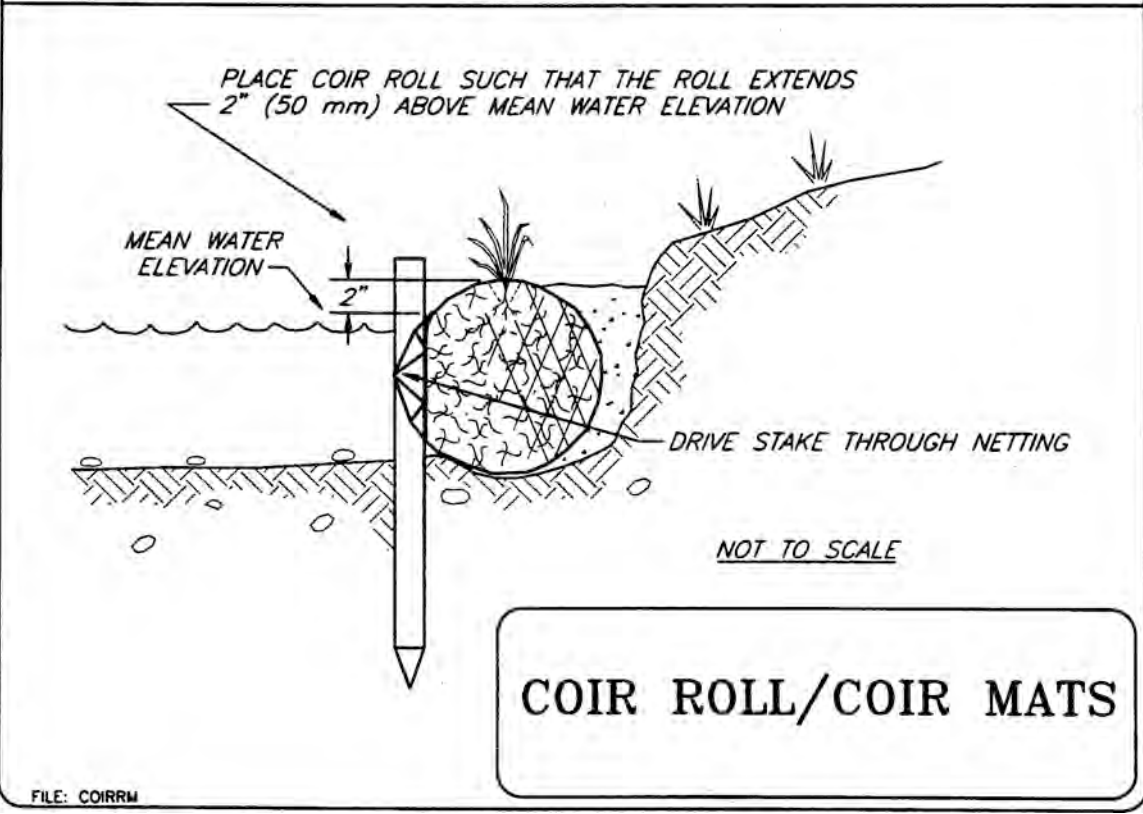
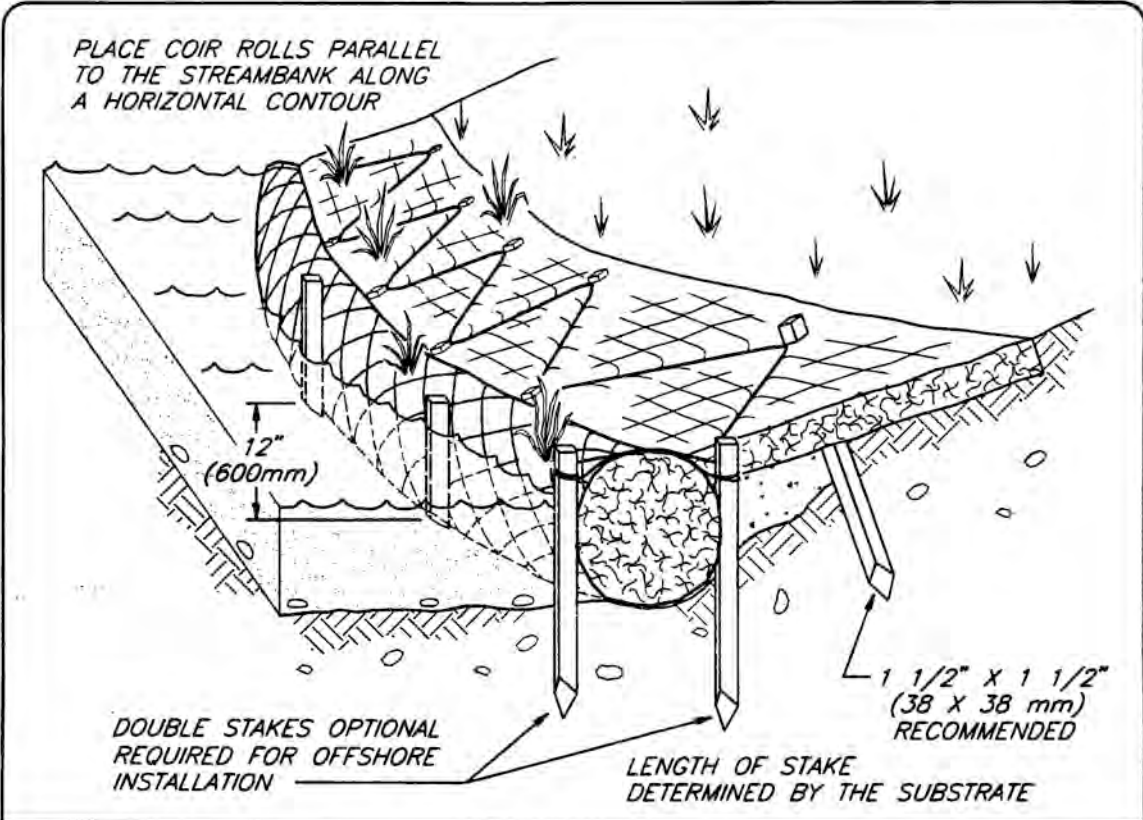

BMP – BROADCAST SEEDING

DESCRIPTION

Hand seeding is broadcasting grass seed on disturbed or bare soil areas by hand or a hand seeding device. This BMP reduces the potential for soil to become water or air borne, reduces erosion after vegetation establishment, provides for vegetative buffers and aids in habitat protection. Seeding with appropriate seed mixes also helps discourage colonization by non-native and invasive plant species.

APPLICATIONS

We encourage hand seeding whenever possible to aid in controlling erosion on construction sites. Seed only areas intended to be left dormant for a year or more, such as soil berms.

LIMITATIONS

- ✓ After broadcast seeding, mulch the area and/or install erosion control blankets or mats.
- ✓ Schedule seeding to fit the germination timing for the specific grasses to be used. Typically this is October and November for cool season California grasses. If seed is applied earlier, increase the seed and mulch quantities.
- ✓

CONSTRUCTION GUIDELINES

- 1) Select seed mixes appropriate to the season and site conditions. Permit conditions and/or sensitive locations may require special seed mixes. Avoid the use of tall growing flashy fuel types or types with known allelopathy such as annual rye grass. Consider native perennials whenever possible.
- 2) Grade as needed and feasible to permit the use of equipment for seedbed preparation.
- 3) Grade and scarify the site as needed and feasible to permit good seed to soil contact. See BMP Surface Roughening and Soil Tracking. Commercial fertilizers are seldom recommended as they can leach into the stream and the high nitrogen promotes broadleaf weed growth over native perennial growth. In areas where there is no longer topsoil, consider amending the soil with mycorrhizal inoculants and/or mature screened compost.

- 4) Install needed erosion control practices, such as sediment basins, diversion dikes and channels, prior to seeding. Divert concentrated flows away from seeded areas.
- 5) Surface roughening: If the area has been recently loosened or disturbed, no further roughening is required. When the area is compacted, crusted or hardened the soil shall be loosened with disking, raking or harrowing.
- 6) Spread seed uniformly and according to manufacturer's recommendations.
- 7) Straw mulch, erosion control blankets or mulch and tackifiers/soil binders should be applied over the seeded areas.

BMP MAINTENANCE

- ✓ Inspect during seed establishment period. Re-seed, due to mortality, as necessary. Areas that fail to establish cover adequate to prevent sheet and rill erosion will be reseeded as soon as such areas are identified. Spot seeding can be done on small areas to fill in bare spots where grass did not grow properly.

BMP REMOVAL

- ✓ BMP removal should not be necessary.

BMP – HYDROSEEDING

DESCRIPTION

Hydroseeding is broadcasting grass seed, tackifier, wood fiber mulch and water on disturbed areas using a hydroseeding machine. This BMP is used to reduce the potential for soil becoming water or air borne, to reduce erosion after vegetation is established, provide vegetative buffers and to aid in habitat protection. Seeding with appropriate seed mixes will also help discourage colonization by non-native and invasive plant species.

APPLICATIONS

Hydroseeding may be used after soil disturbance is completed at construction sites and/or on bare slopes.

LIMITATIONS

- ✓ Hydroseeding should not be used on streambanks or in areas subject to scour.
- ✓ Schedule seeding to fit the germination timing for the specific grasses to be used. Typically this is October and November for cool season California grasses. If seed is applied earlier, increase the seed and mulch quantities

CONSTRUCTION GUIDELINES

- 1) Select seed mixes appropriate to the season and site conditions. Permit conditions and/or sensitive locations may require special seed mixes. Avoid the use of tall growing flashy fuel types or types with known allelopathy ¹such as annual rye grass. Consider native perennials whenever possible. Commercial fertilizers are seldom recommended as they can leach into the stream and the high nitrogen promotes broadleaf weed growth over native perennial growth. In areas where there is no longer topsoil, consider amending the soil with mycorrhizal inoculants and/or mature screened compost
- 2) Install needed erosion control practices, such as sediment basins, diversion dikes and channels, prior to hydroseeding. Divert concentrated flows away from hydroseeded areas.

¹ If a plant type is allelopathic, it exudes chemicals into the surrounding soil that discourage or inhibit other plant types from growing. Eucalyptus is a commonly known allelopathic species.

- 3) Surface roughening: If the area has been recently loosened or disturbed, no further roughening is required. When the area is compacted, crusted or hardened the soil shall be loosened with discing, raking or harrowing.
- 4) Spread hydroseed mix uniformly and according to manufacturer's recommendations.
- 5) Cover hydroseeded areas with other methods as needed.

BMP MAINTENANCE

- ✓ Inspect during seed establishment period. Re-seed, due to mortality, as necessary. Areas that fail to establish cover adequate to prevent sheet and rill erosion will be reseeded as soon as such areas are identified. Spot seeding can be done on small areas to fill in bare spots where grass did not grow properly.

BMP REMOVAL

- ✓ BMP removal should not be necessary.

BMP – MULCHING

DESCRIPTION

Mulching is the application of sterile *weed-free* straw, wood fiber (*as in hydromulch*), local leaf litter, mature screened compost or other suitable materials to the soil surface. This BMP is used to reduce the potential for soil becoming water or air borne, and to encourage vegetation establishment.

Typically, apply an erosion control seed mix to scarified bare ground and cover bare areas where surface erosion and sediment delivery could occur. Rates of about 4,000 pounds/acre, or approximately 50 bales/acre of straw, meet this standard. Use mulch to cover seed to improve microclimatic conditions for germination and seedling survival. Seeding and mulching rates are highly variable, depending on the seed mix used. Consult your local extension office or seed supplier for recommended rates of application and local site conditions.

APPLICATIONS

This BMP may be used to provide protection to the soil surface and to protect newly seeded areas. This BMP may be used in combination with plantings.

LIMITATIONS

- ✓ Mulch may not adhere well to slopes steeper than 2:1.
- ✓ Mulch should not be placed in water bodies or in ditches where water flow is continuous.

CONSTRUCTION GUIDELINES

- 1) Mulch should be applied so that the soil is covered enough to allow seeds to protect against erosion, but still allow seeds to germinate.
- 2) Select the appropriate mulch for the site. Local leaf litter or on-site grass mowings may be preferred if available. Rice straw is relatively weed free in upland areas but not necessarily the best choice for wetlands. Irrigated cereal grains and sterile wheat straw may be appropriate, but residual germination may compete with target revegetation species. Wood fiber mulch provided by hydromulchers is the most sterile medium. Mature screened compost is effective both for erosion control and as a soil builder.”

- 3) In areas subject to runoff or wind erosion, mulch shall be secured to the soil by mechanical or manual crimping, anchoring with branches, plant-derived tackifiers, or other appropriate methods.

BMP MAINTENANCE

- ✓ Conduct periodic inspections and reapply mulch where missing.

BMP REMOVAL

- ✓ BMP removal is not necessary.

BMP – PLANTING

DESCRIPTION

Planting, as outlined in this BMP, involves the establishment of native woody perennial species for the purpose of erosion control and/or habitat enhancement. See also Hand Seeding, Hydroseeding, and Mulching BMPs.

APPLICATIONS

Wherever riparian or upland woody vegetation is required and it is determined that natural recruitment will not be sufficient.

LIMITATIONS

- ✓ Sources of good quality locally native plant materials may be limited.
- ✓ An extended establishment period may require years of maintenance.
- ✓ Sources of water for irrigation may be limited.
- ✓ Permit requirements may guide design and maintenance planning.

CONSTRUCTION GUIDELINES

- 1) Choose the appropriate species for the site as determined by what is growing in the surrounding areas, soil type, water requirements, exposure, wildlife species requirements and permit requirements. Spacing and structure must also be considered.
- 2) Schedule the planting time as appropriate for the species and project maintenance capabilities. Riparian and upland species should be planted in November and December. The planting window for willow sprigs may be extended into the late summer (but not spring) if irrigation is provided. Emergent species may be planted after high flows if sufficient water will be available.
- 3) Order plant materials from a reputable native plant nursery well in advance to allow the nursery time to collect and propagate local species. Nine months to two years lead time may be required.

- 4) Inspect nursery-grown plant materials prior to accepting. Avoid tree species grown in one gallon flat bottom pots which promote root girdling. Revegetation plans typically specify tree size – for example:
 - Tree Species: Trees, with the exception of cottonwood, willows, and dogwood, shall be grown from locally collected seed. Tree species shall be grown in 14-inch deep Treepots™ for at least 9 months and shall have root systems that fill the containers but are not root bound; roots shall show active growing tips. The minimum stem caliper of the main trunk shall be 0.2 inches at 1 inch above the root crown. Tops shall be at least 6 inches tall and have healthy, live buds and/or leaves, with no broken leaders.
 - Shrub and Vine Species: Shrubs and vines shall be grown from seeds or cuttings, except elderberry, which shall be grown from seed. Shrubs and *vines* shall be grown in 10-inch deep Deepots™ or one gallon pots for at least 9 months and shall have root systems that fill the containers but are not root bound; roots shall show active growing tips. The minimum stem caliper of the main trunk of elderberries shall be 0.2 inches at 1 inch above the root crown. All other species shall either have a similar caliper or have sufficient number of stems of a sufficient size to be equivalent to a 0.2-caliper single stem. Tops shall have healthy, live buds and/or leaves.
 - Plants shall show no signs of deleterious infection from bacteria, fungus, or insects. Reject plants with open wounds or unusual swelling of stems or branches.
 - Willow sprigs shall be 0.75 inch to 1.5 inches in diameter at the base and 3 feet long. Sprigs shall be cut clean with sharp hand saws. Branches shall be pruned off with sharp shears close to the main stem but just outside the branch collar. Sprigs with swelling, scar tissue, boring insects, or disease shall be rejected. Sprigs shall be cut from live healthy materials. Donor trees or areas of trees from which sprigs are cut shall be pre-approved by the owner. No more than 50% of an existing cottonwood or willow clump shall be removed for sprigs, unless the clump is scheduled to be destroyed by grading. No sprigs shall be taken from within 20 feet of a willow or cottonwood with an active bird nest in it.
- ✓ Site preparation includes the removal of all vegetation in the planting area. Scalp a 3 foot by 3 foot area free of vegetation and debris down to bare mineral soil.
- 5) Install plants according to attached drawings. If significant rain is not forecast, water-in the plants.
- 6) Where deer or rabbit browse is anticipated, it may be necessary to install browse protectors. If the riparian zone has high velocity floods, wait until early spring to

install protectors. Welded wire cages around cottonwoods may be required if beavers are in the area.

- 7) Schedule irrigation and maintenance requirements according to the needs of the plants and conditions. Maintenance may be required for one to three years. If watering is required, supplemental watering must begin in early spring (March) or as soon as the surface soil begins to dry.

BMP MAINTENANCE

- ✓ Regular inspection of plantings should be anticipated. As often as once per week, but no less than once per month for the first year.
- ✓ Maintenance includes weeding, watering, repair to browse protectors at a minimum.
- ✓ Where irrigation is required, it is essential to begin irrigation in the spring (March or April) before the soil begins to dry. This is the time when the plant and nearby weedy species put on the most growth and have the highest water demand. Transplants are most susceptible to drought in the spring and early summer. At the same time, it is important not to waterlog native species. Allow the soil surface (top ½ inch) to dry between waterings.
- ✓ Monitor plant survival in October to anticipate plant replacement that may be required by permit.
- ✓ Trimming lower branches of willows to allow for unrestricted stream flow may be desirable.

BMP REMOVAL

- ✓ It may be necessary to remove irrigation lines, browse protectors, and other materials at the end of the establishment period.

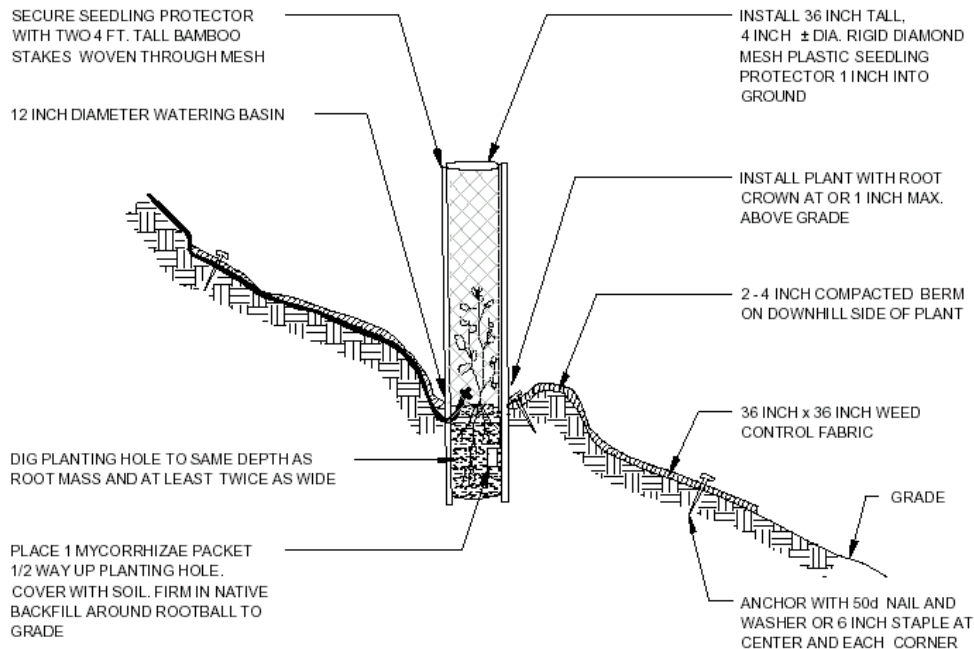
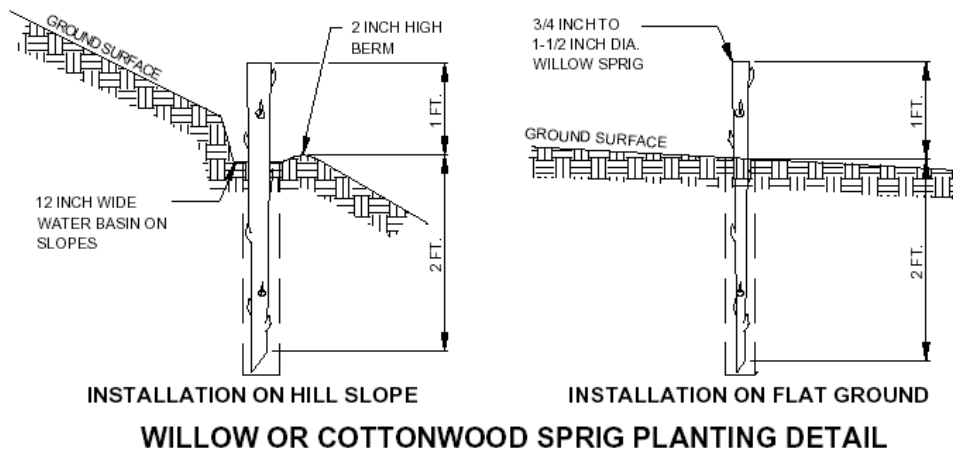

NOTE: SEEDLING PROTECTORS TO BE PLACED ON TREES ONLY. SHRUBS AND VINES TO BE PLANTED AS ABOVE WITHOUT SEEDLING PROTECTOR. REMOVE PROTECTOR AFTER 3 YEARS.

Source:
 ©Prunuske Chatham, Inc.
 Occidental, CA

PLANTING

BMP – SURFACE ROUGHENING and SOIL TRACKING FOR PLANTING PREPARATION

DESCRIPTION

Surface roughening is a technique for roughening a bare soil surface with furrows running across the slope, stair stepping, or tracking with construction equipment. Surface roughening is intended to aid the establishment of vegetative cover from seed, to reduce runoff velocity and increase infiltration, and to reduce erosion and provide for sediment trapping.

APPLICATIONS

All construction slopes require surface roughening to facilitate long-term stabilization with vegetation, particularly slopes steeper than 3:1.

LIMITATIONS

Slopes may be impossible to get machinery on due to steepness of slope or difficult access. Hand raking across the slope may be the only way to roughen the surface.

Do *not* use this BMP:

- ✓ on slopes with a rock surface.
- ✓ unless simultaneous revegetation/seeding is planned.

CONSTRUCTION GUIDELINES

Cut Slope Roughening:

- 1) Stair-step grade or groove the cut slopes that are steeper than 3:1.
- 2) Use stair-step grading on any erodible material soft enough to be ripped with a bulldozer. Slopes consisting of soft rock with some subsoil are particularly suited to stair-step grading.
- 3) Make the vertical cut distance less than the horizontal distance, and slightly slope the horizontal position of the "step" in toward the vertical wall.
- 4) Groove the slope using machinery to create a series of ridges and depressions that run across the slope, on the contour.

Fill Slope Roughening:

- 1) Place fill slopes with a gradient steeper than 3:1 in lifts not to exceed 8 inches, and make sure each lift is properly compacted.

- 2) Ensure that the face of the slope consists of loose, uncompacted fill 4-6 inches deep.
- 3) Use grooving or tracking to roughen the face of the slopes, if necessary.
- 4) Apply seed, fertilizer and straw mulch then track or punch in the mulch with the bulldozer.
- 5) Do not blade or scrape the final slope face.

Roughening With Tracked Machinery:

- 1) Limit roughening with tracked machinery to soils with a sandy textural component to avoid undue compaction of the soil surface.
- 2) Operate tracked machinery up and down the slope to leave horizontal depressions in the soil. Do not back-blade during the final grading operation.
- 3) Immediately seed and mulch roughened areas to obtain optimum seed germination and growth.

BMP MAINTENANCE

- ✓ During construction, inspect BMPs daily during the workweek.
- ✓ Schedule additional inspections during storm events. Check for erosion and sloughing, and make any required repairs.

BMP REMOVAL

- ✓ BMP removal is not necessary.

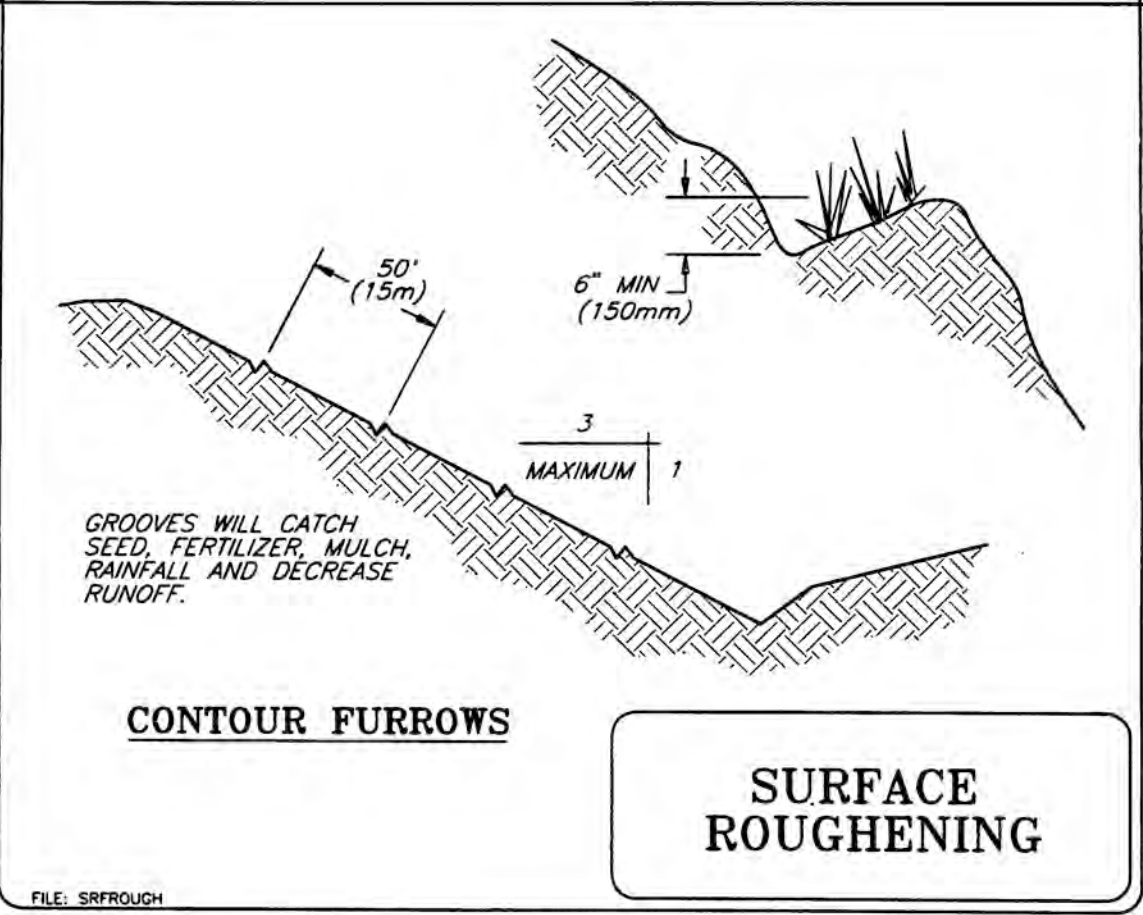
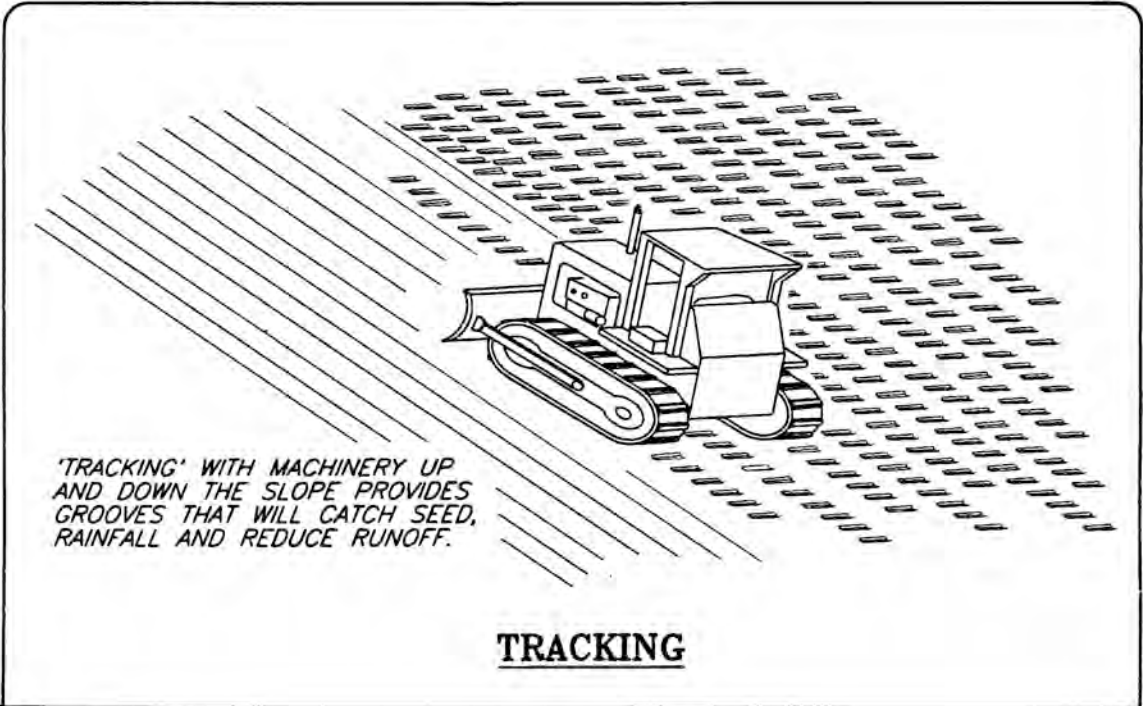

© 1994 JOHN McCULLAH
FILE: SRFROUGH

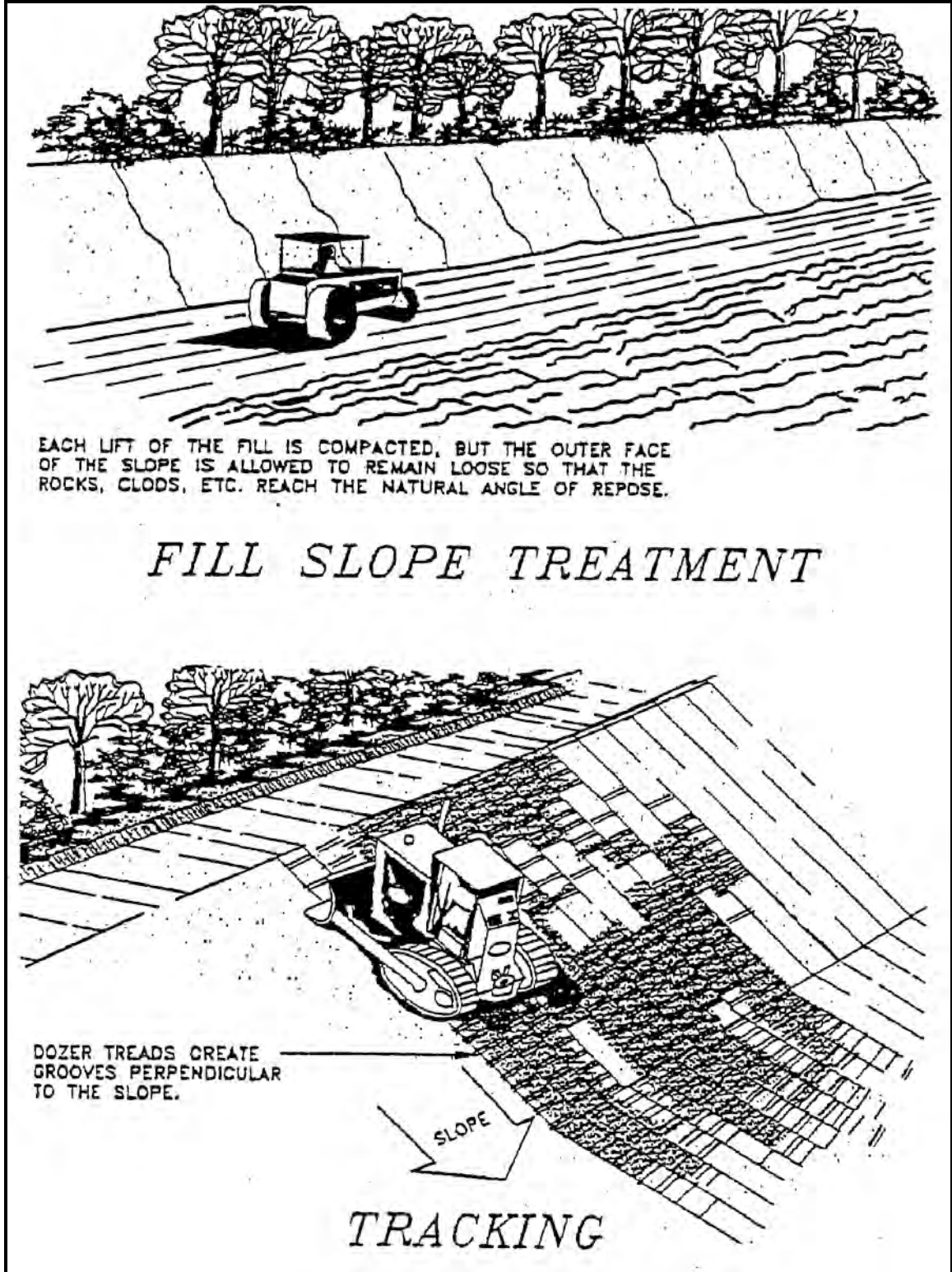

Source: Tri-County Regional Road Maintenance ESA Program Guidelines, Washington State, July 2000

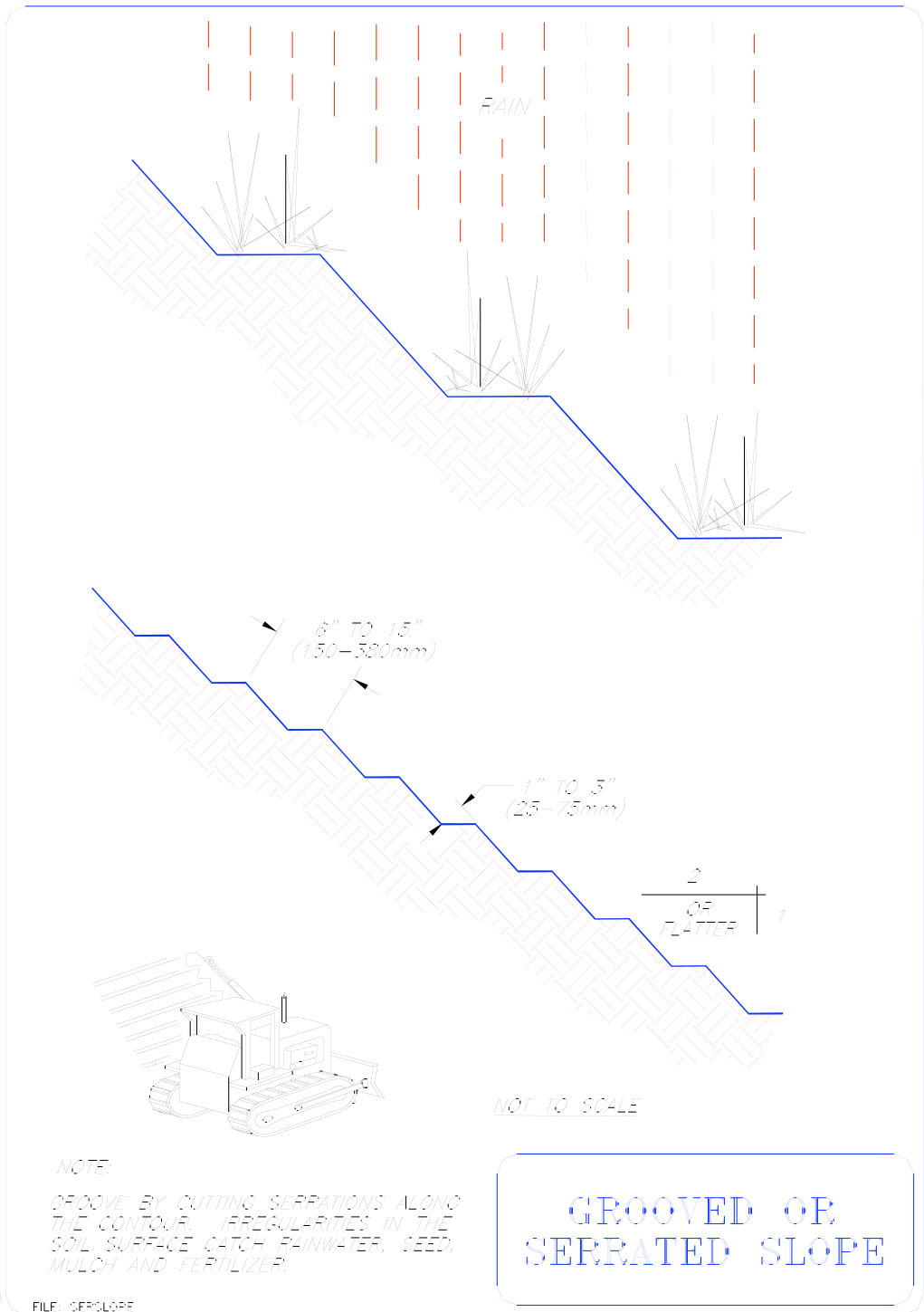

BMP – STEPPED OR TERRACED SLOPE

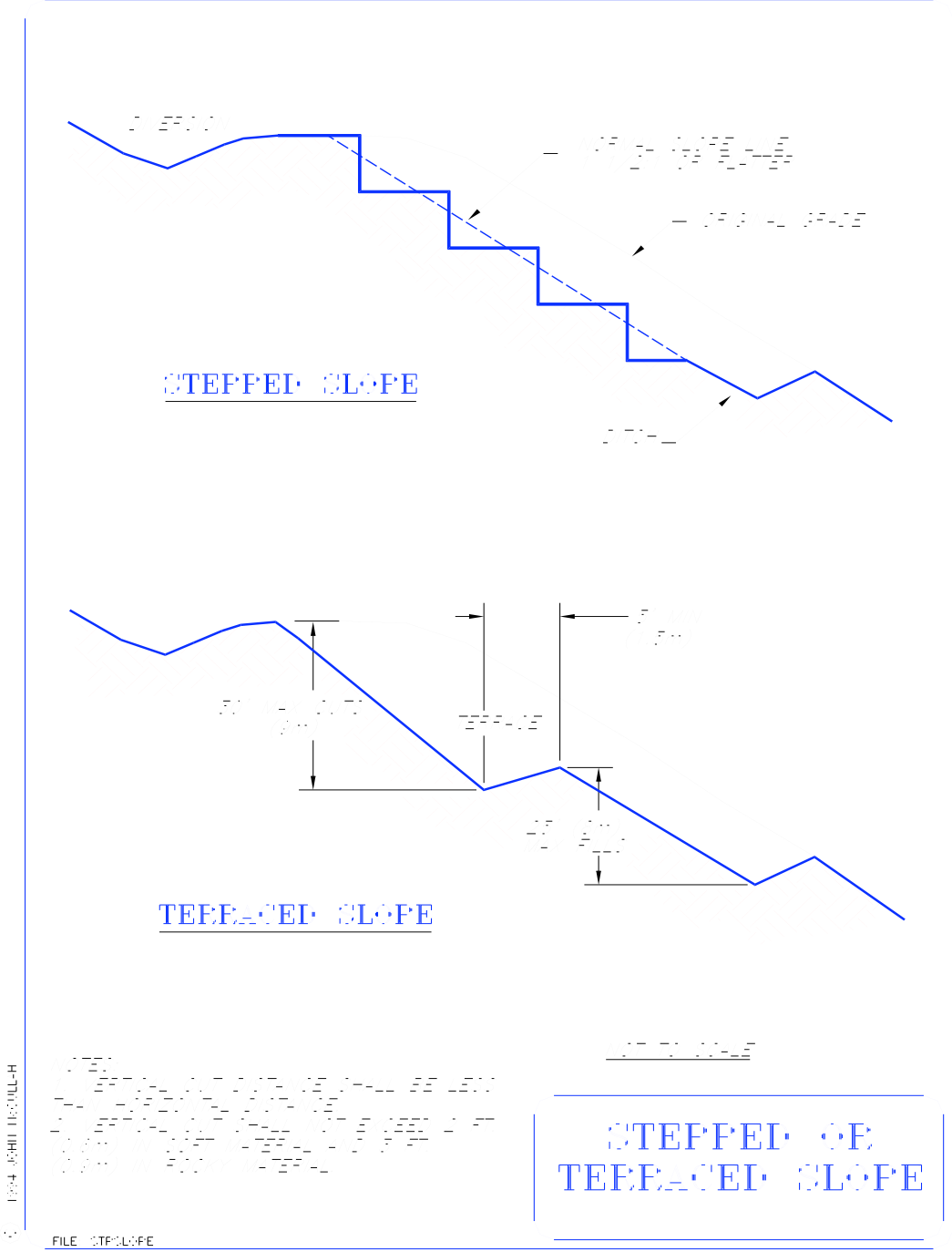

BMP – PLASTIC COVERING

DESCRIPTION

Plastic covering is a temporary soil stabilization method. Material should be polyethylene sheeting at least 6 mils thick.

APPLICATIONS

Plastic covering can be used to stabilize stockpiled materials and unfinished slopes to protect from erosion caused by wind and water. Also used to cover spills during rainfall to reduce pollutant dispersion as clean-up proceeds.

LIMITATIONS

- ✓ Plastic is easily vandalized, torn, and photodegradable and must be disposed of in a landfill.
- ✓ Plastic results in 100% runoff, which may cause serious erosion problems in the areas receiving the increased flow.

CONSTRUCTION GUIDELINES

- 1) Plastic covering should be anchored by sandbags placed no more than 10 feet apart and by keying into the tops of slopes to prevent infiltration of surface waters under the plastic. On steep slopes, attach rope between bags to keep them from sliding.
- 2) Seams should be taped or weighted down along their entire length and there should be at least a 12 to 24-inch overlap of all seams.
- 3) Stockpiles should be located a minimum of 50 feet away from concentrated flows of stormwater, drainage courses, and inlets.
- 4) Perimeter sediment barriers such as silt fences, berms, or straw wattles may be required.

BMP MAINTENANCE

- ✓ Plastic covering should be checked regularly during construction.
- ✓ Installation should be checked during and after any significant storms to check for erosion and undermining.

- ✓ Repair and/or replace perimeter controls and covers as needed to keep them functioning properly.

BMP REMOVAL

- ✓ Plastic covering and related materials may be reused if in good condition, otherwise materials should be removed from the site and disposed of properly.

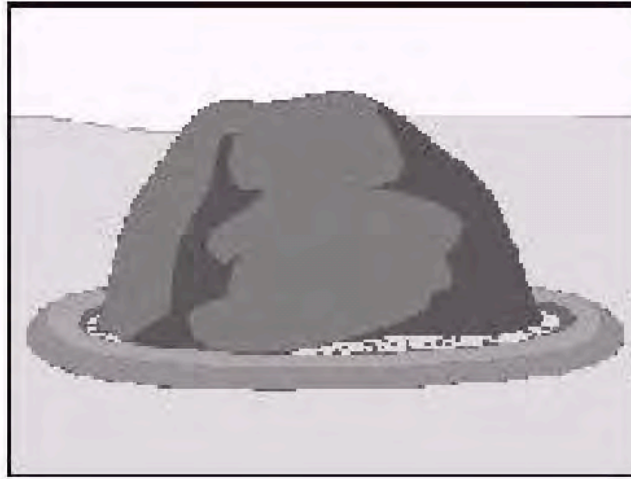

- Plastic sheeting shall be polyethylene and have a minimum thickness of 6 mil.
- No runoff shall be allowed to run under the plastic covering.
- Covering shall be installed and maintained tightly in place by using sandbags on ropes with a maximum 10 foot grid spacing in all directions. All seams shall be taped or weighted down full length and there shall be at least a 12-inch overlap of all seams. For seams parallel to the slope contour, the uphill sheet shall overlap the downhill sheet.
- Drainage from areas covered by plastic sheeting shall be controlled such that no discharge occurs directly onto uncontrolled, disturbed areas of the site.

Source:
CASQA California Stormwater Quality
Association. California Stormwater BMP
Handbook for Construction
www.cabmphandbooks.com and
Cowlitz County, WA www.co.cowlitz.wa.us

**PLASTIC
COVERING:
TEMPORARY**

BMP – ROCK BREAST WALL

DESCRIPTION

A low retaining wall (usually 10 feet or less in height) constructed against the base of a slope. The wall is usually built by stacking rocks atop one another in a single, one-rock width course. Synonyms include gravity wall, loose rock retaining wall, rock armoring.

APPLICATIONS

Constructed to protect the toe of the slope and to prevent slope damage by erosion, especially piping and spring seepage from the face of the slope.

LIMITATIONS

- ✓ Careful rock placement is required to prevent injuries to construction workers and others.
- ✓ Existing slope must be geologically stable.

CONSTRUCTION GUIDELINES

- 1) Toe or footing trench into native material is required as shown.
- 2) Method of placement must meet Caltrans Method A standards for ½ ton class rock: “Larger rocks shall be placed in the footing trench. Rocks shall be placed with their longitudinal axis normal to the embankment face and arranged so that each rock above the foundation course has a 3-point bearing on the underlying rocks. Foundation course is the course placed on the slope in contact with the ground surface. Bearing on smaller rocks which may be used for chinking voids will not be acceptable. Placing of rocks by dumping will not be permitted. Local surface irregularities of the slope protection shall not vary from the planned slope by more than 0.3-m measured at right angles to the slope.”
- 3) Slope face of wall shall not be steeper than 0.5 horizontal to 1 vertical.
- 16) Walls need to be engineered. Rock size, rock thickness, and toe width will vary.

BMP MAINTENANCE

- ✓ Inspect wall for movement and settling. Repair as needed.

ROCK BREAST WALL

Description: A rock breast wall is a low retaining wall (usually 10 feet or less in height) constructed against the base of a slope. The wall is usually built by stacking rocks atop one another in a single, one-rock width course.

Purpose: To defend the toe of the slope and to prevent slope damage by erosion, especially piping and spring sapping as a result of seepage exiting from the face of the slope.

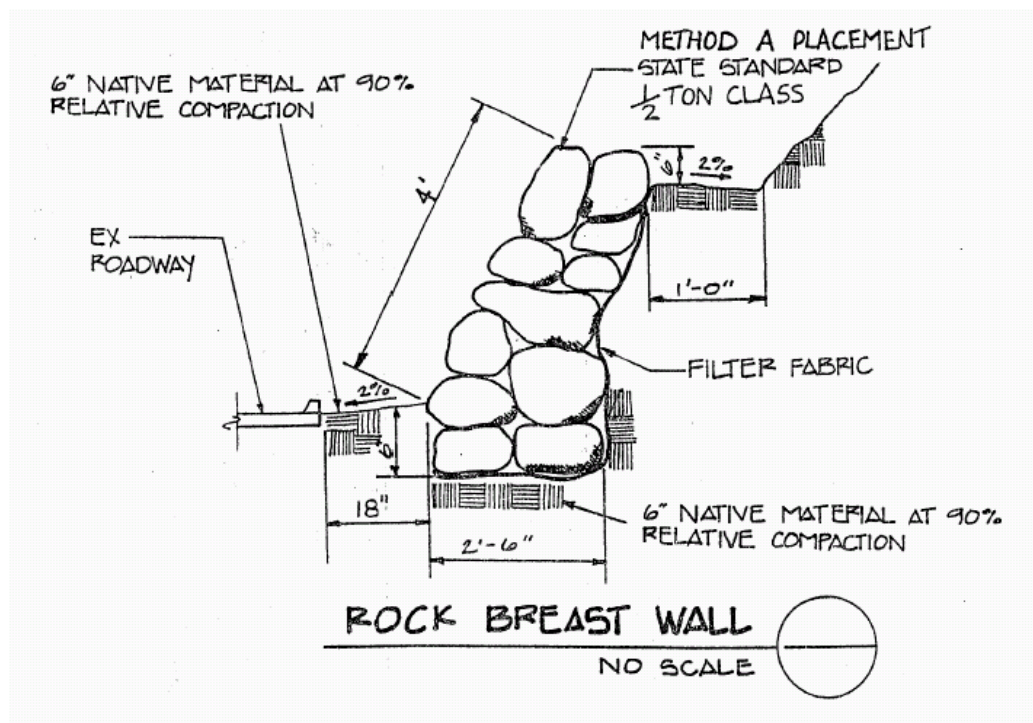

Source: Caltrans – Lake Tahoe district office (1994).

BMP – VEGETATED GEOBERM TOE WALL

DESCRIPTION

A vegetated geoberm toe wall consist of continuous berms that are filled with gravel, sand or soil and then constructed with brush layering techniques. The continuous berms are geotextile tubes filled with soil. They can be used to stabilize and reinforce the toe of the eroding streambanks or the raveling toe of slides and road cuts.

APPLICATIONS

Continuous Berm toe walls can be constructed on over-steepened road cuts and at the toe of shallow landslides on sandy and glacial till material. May be constructed in place of retaining walls, rock toe walls, or slope toe protection measures.

LIMITATIONS

- ✓ Currently, only a Continuous Berm Machine (CBM) can make the berms. A “spreader bar” is necessary to lift the individual berms into place.
- ✓

CONSTRUCTION GUIDELINES

- 1) Geoberm Toe Walls are easy to construct. They are very conducive to brush layering techniques. Branch cuttings, live stakes and pole planting techniques are incorporated into the design and construction. The berms can be made from woven or non-woven geotextile fabric. However 6-10 oz non-woven fabric has worked well in the past.
- 2) For toe walls, construct the first course of berms on a stable base approximately 3 m (10 feet) wide, which is dipping into the slope at an angle. Use MBW Inc.’s CBM or wrap soil lifts with geotextile material to construct the geo revetments. Use Brush Layering techniques between each lift 0.2-0.5 m (8-18 inches) high. Each lift should be moderately compacted with the surface dipping into the slope.
- 3) Place cuttings with butt ends dipping down and into the bank and backfill with gravel and soil if possible. Geo grids can be used in the lifts to further reinforce the slopes.
- 4) Place next berm or soil lift sloped back to the desired angle. Live stakes, driven through the fabric at angles (toe nailed) and pole cuttings may be used to secure

the continuous berms and soil wraps. Install some live stakes and poles deeply to reach moisture and to secure the structure.

BMP MAINTENANCE

- ✓ Conduct periodic inspections and repair berms as necessary.
- ✓

BMP REMOVAL

- ✓ Removal should not be necessary.
- ✓

ADDITIONAL RESOURCES

MBW, Inc. (Continuous Berm Machine), PO BOX 378, 250 Hartford Rd. Slinger, WI 53086-0378, (414) 644-5234, www.mbw.com

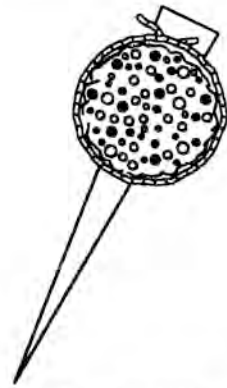

**DETAIL FIBER ROLL
OR WILLOW WATTLE**

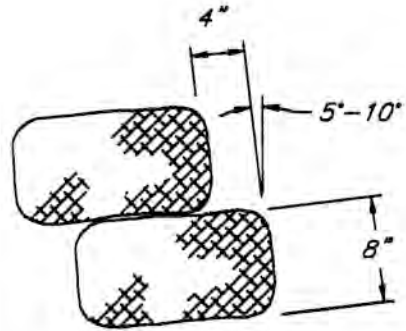

Constructed with continuous berm machine (CBM) using 6-12oz./yd. non woven geotextile filter fabric filled with native soil, sand or gravel.

DETAIL-CONTINUOUS BERM

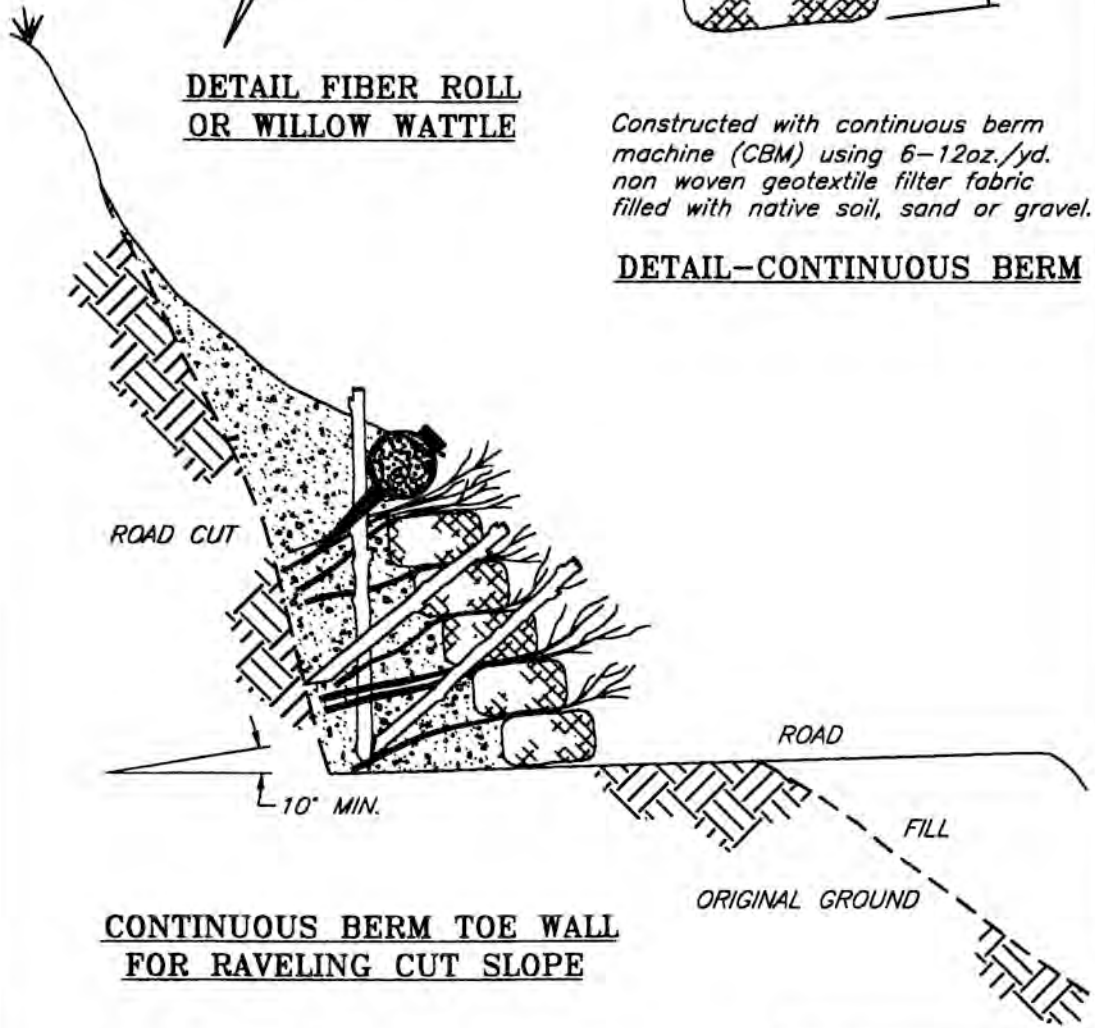

**CONTINUOUS BERM TOE WALL
FOR RAVELING CUT SLOPE**

NOTE:
Toe walls are intended to reduce the angle of repose and stabilize raveling slopes.

**VEGETATED
GEOBERM
TOE WALL**

© 2000 JOHN McCULLAH

FILE: VGBERMTW

SEDIMENT MANAGEMENT BMPS

- **BRUSH PACKING** (Brush Mattress; see Streambank Protection)..... A-93
- **CHECK DAM – ROCK** A-97
- **CHECK DAM – STRAW BALE** A-101
- **CONCRETE WASHOUT**..... A-103
- **CONTAINMENT OF CONCRETE POURS**..... A-107
- **SILT MAT INLET**..... A-109
- **SILT MAT/VEGETATED GRASSY SWALE**.....A-113
- **SILT FENCE** A-117
- **SEDIMENTATION SUMP**..... A-125
- **SILTATION POND/SETTLING POND** A-129
- **STORM DRAIN INLET PROTECTION** A-135
- **SWEEPING** A-139
- **TURBIDITY CURTAIN** A-141

BMP - BRUSH PACKING

DESCRIPTION

Brush packing is a biotechnical gully and slump repair technique. Brush packing utilizes alternating layers of live branch cuttings (from rootable plant species) and soil to repair large rills, gullies, and slumps. The brush packing technique is more appropriate for the repair of gullies on slopes, and it can be implemented with hand labor.

Brush mattresses employ the same principles and are typically used on road slipouts and bioengineered streambank stabilization projects. (See BMP-Brush Mattress, Streambank Protection-Biotechnical BMPs.)

APPLICATIONS

Since brush packing involves refilling the gully with soil between successive layers of branches, this practice is not recommended for gully repair in drainages or ephemeral stream channels. The slope and gully must have soil material available with which to fill the slumps and gullies. Brush packing should be used in conjunction with slope scaling or slope grading activities where rills, gullies, and other channels are removed by re-grading.

LIMITATIONS

- ✓ Not suitable for the stabilization of deep, organic topsoil layers.
- ✓ Live materials should be harvested and constructed during the dormancy stage of plant growth.
- ✓ Permits may be required for installation along stream banks.
- ✓ Usually requires manual labor to fill and re-grade slope.

CONSTRUCTION GUIDELINES

- 1) It is imperative to treat any source of concentrated flows or other causes of gullying, before performing brush-packing treatments. Cut branches to a length which corresponds to the depth of the gully. Branches should extend the entire depth of the rill or gully, with tips protruding from the slope face when grading is complete. Branch cuttings shall be a mixture of younger wood and older wood, from 6-50 mm (¼-2 inches) diameter.

- 2) Fill the bottom of the rill, gully, or slump with soil, approximately 12 inches, and shape and compact the soil terrace such that it dips into the slope. Place branch cuttings, 3-8 inches thick, in a crisscross or overlapping configuration. The growing tips shall protrude 6-12 inches from the slope face, with the basal ends dipping back into the slope. It is important that the basal ends of the branches are lower than the branch tips. Live stakes may be driven through the soil-branch layers for extra stabilization.
- 3) Continue re-grading the slope and cover the brush layer with a 150-300 mm (6-12 inch) layer of soil. Compact to ensure good soil contact with the branch cuttings. Then, continue brush packing and soil layering until the gully is filled and the slope is re-graded. The final installation should match the existing slope with the in-field section slightly higher to ensure that runoff collection and channelization does not occur.
- 4) Seed and mulch the slope. Shallow slopes, generally 3:1 or flatter, may be seeded and mulched by hand. Steeper slopes should have seed applied hydraulically and the mulch shall be anchored with tackifier or other approved methods.

BMP MAINTENANCE

- ✓ Conduct regular inspections and maintenance, particularly during the first year.
- ✓ Immediately correct and repair failures of fill or drainage structures.

MATERIALS

- ✓ Live materials needed include branches and cuttings of deciduous woody plants capable of producing adventitious roots, most appropriately willow. Straw or other mulch can be mixed with soil to help fill in the gully.
- ✓ Coir netting or erosion control blanket material can be wrapped around the soil layers to protect the slope face (see Reinforced Earthfill with Brush Layering).
- ✓ Polypropylene geogrids can be incorporated into the soil layers if additional strength and durability are desired.

BMP REMOVAL

- ✓ Not required.

NOTE:
Rooted, leafed condition of the living
plant material is not representative
of the time of installation.

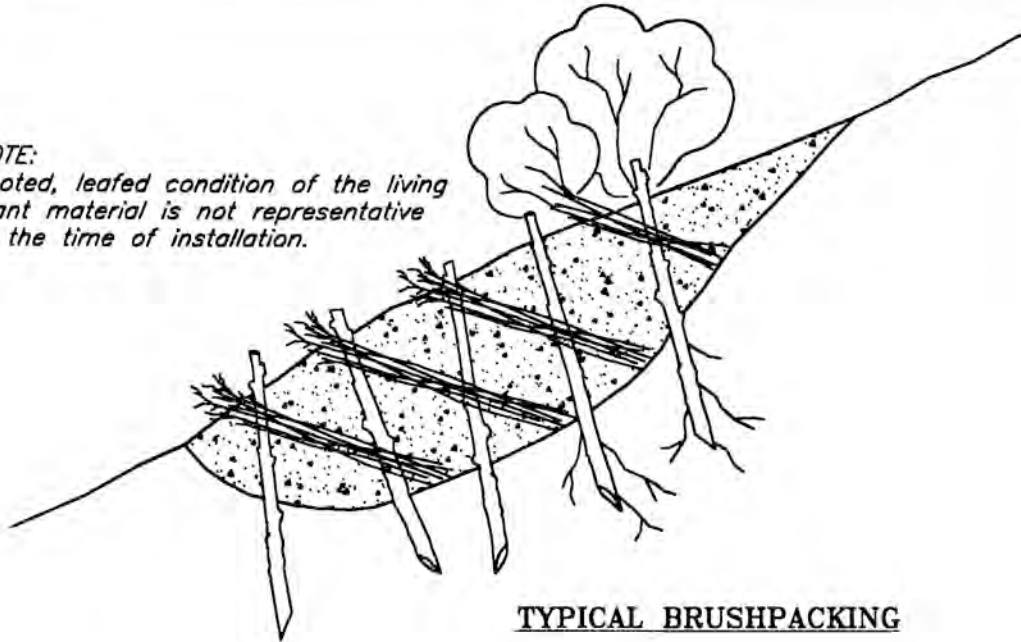

TYPICAL BRUSHPACKING

BOTTOM OF GULLY/SLUMP

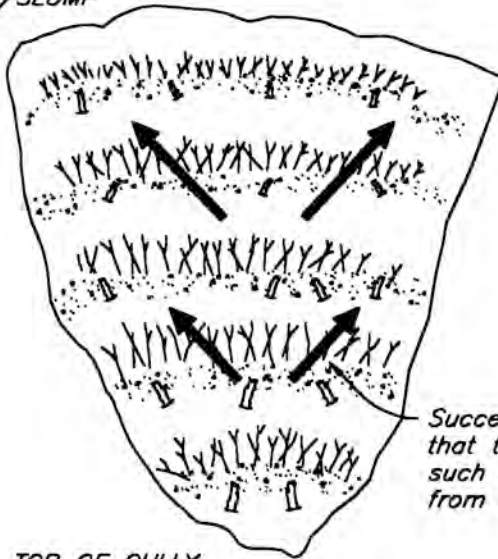

Successful brushpacking requires
that the gully be filled convex
such that runoff drains away
from the center.

TOP OF GULLY

PLAN VIEW

**BRUSHPACKING FOR
SLUMP/GULLY REPAIR**

© 2000 JOHN McCULLAH

FILE: BRSHPSGR

BMP – CHECK DAM: ROCK

DESCRIPTION

A semi-porous rock grade control structure.

APPLICATIONS

Use only in small upland drainages and gullies. Used to provide channel grade stability. May be designed to trap sediment for removal. See BMP Sediment Sump - Trap.

LIMITATIONS

- ✓ Maximum weir height is 5 feet.
- ✓ Check dams tend to flatten the channel grade and can cause upstream meandering which may erode stream banks and cut around the structure.
- ✓ An adequate cutoff trench into competent native ground is essential.
- ✓ The rock on the weir must be correctly placed and sized or the structure will fail.
- ✓ Cannot be used in fish bearing streams.

CONSTRUCTION GUIDELINES

- 1) Weir opening must be large enough for the design flow (25 year or greater) plus one foot of freeboard.
- 2) Center cutoff trench must be keyed into native ground to a depth of 2 feet both underneath and on the sides of the structure.
- 3) Toe trench at downstream end is critical to prevent undercutting. See drawing.
- 4) Rock is placed in an interlocking matrix with each rock supported at a minimum of three points. Fill voids between large rocks with small rock. Typically rock shall have a minimum specific gravity of 2.7 and a minimum diameter of 18 inches (rock size and density may be specified by project engineer). Use smaller rocks to chink into voids.
- 5) Coir mat, filter fabric, or a gravel blanket is used as shown to prevent fines from moving through rock voids.
- 6) Rock check dams may be constructed in a series with the toe of the upstream dam approximately level with the weir opening of the downstream dam.

- 7) Engineered fill placed to a designed gradient upstream of the check dam is preferable to random sediment accumulation.

BMP MAINTENANCE

- ✓ Adjust rock if displaced.
- ✓ If upstream channel begins to cut around structure, remove rock in middle of weir to widen and lower opening.

BMP REMOVAL

- ✓ N/A

NOTES

TO BE USED IN SMALL UPLAND DRAINAGES AND GULLIES ONLY.

ROCK SIZE AND DENSITY TO BE SPECIFIED BY PROJECT ENGINEER.

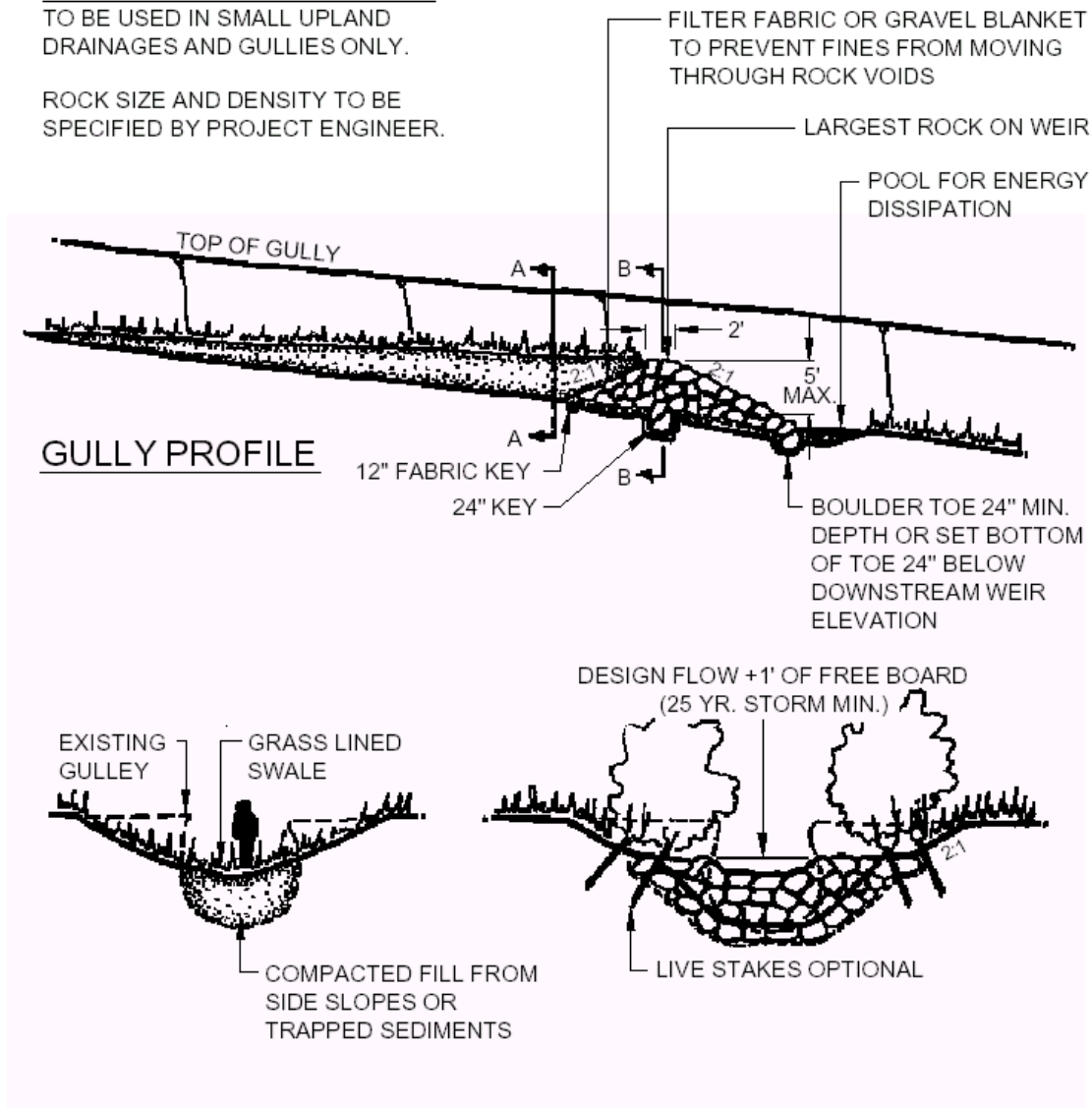

SECTION A A

SECTION B B

Source:
©Prunuske Chatham, Inc.
Occidental, CA

**CHECK DAM:
ROCK**

BMP – CHECK DAM: STRAW BALE

DESCRIPTION

Temporary sediment catchments constructed of straw bales. Also used as grade control structures to facilitate vegetation establishment.

APPLICATIONS

Use in small upland drainages and gullies only. Used to trap sediment from dewatering operations. (See BMP: Dewatering – Pumping or Draining). May also be used to allow for revegetation in eroded swales.

LIMITATIONS

- ✓ When used as sediment catchments, must be inspected and cleaned out regularly.
- ✓ Temporary structures. Rely on vegetation to stabilize over the long run.
- ✓ Check dams tend to flatten channel grade causing upstream bank-full meandering which may erode stream banks.
- ✓ Adequate cutoff trench into competent native ground is essential. Incorrect installation may cause increased erosion.

CONSTRUCTION GUIDELINES

- 7) Never use metal stakes or rebar to anchor bales unless a provision is included to remove these materials. Metal stakes pose a serious safety hazard.
- 8) Key bales 4 inches into the ground and side banks. Compact moist soil around side banks.
- 9) Center must be lower than sides to act as a spillway. Add rock downstream of center weir bale.
- 10) Secure with a minimum of two wooden stakes per bale.

BMP MAINTENANCE

- ✓ When used as sediment catchments, must be inspected and cleaned out when basin is 60% full.
- ✓ Inspect sediment catchments after each significant storm (1 inch in 24 hours).

BMP REMOVAL

- ✓ Straw bales and stakes used as a catchment basin are removed after the project has stabilized. The area is then smoothed, reseeded and mulched (see Seeding BMP and Mulching BMP).

- ✓ When used as grade control to facilitate vegetation establishment, removal is not required.

CHECK DAM – STRAW BALE

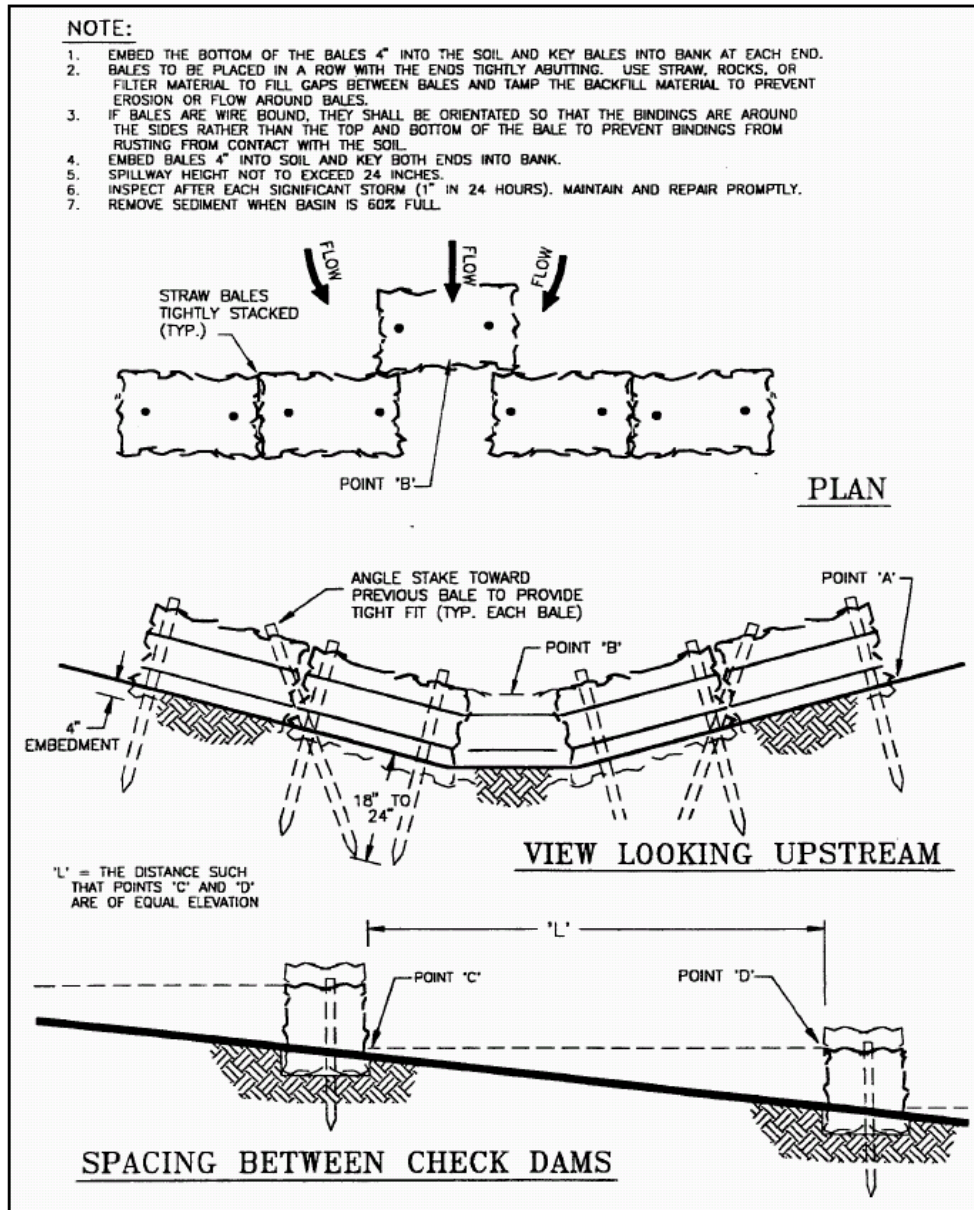

Source: McCullah, J. 1992. Erosion and Sediment Control Standards Design Manual – County of Shasta. Prepared for the Western Shasta RCD. Redding CA. 187 p.

BMP - CONCRETE WASHOUT

DESCRIPTION

Concrete washout areas prevent concrete waste discharges to waterways and storm drains. Concrete and cement-related mortars are toxic to fish and the aquatic environment.

APPLICATIONS

Concrete washouts are applicable for projects that require;

- on-site preparation and use of Portland cement concrete, asphalt concrete, or cement mortar
- equipment washouts

LIMITATIONS

- 4) An appropriate area for the washout must be identified at least 50 feet away from watercourses and storm drains in case of accidental breaching.
- 5) The storage capacity of the basin must be sized correctly for the job.

CONSTRUCTION GUIDELINES

- 1) The location of the concrete washout should be clearly labeled and all employees should be educated about proper concrete disposal.
- 2) Avoid mixing excess amounts of fresh concrete or cement mortar on-site.
- 3) Wash out concrete mixers only in designated washout areas where the water will flow into temporary sealed basins or onto stockpiles of aggregate base or sand. Use as little water as possible to reduce hardening and evaporation time of waste products.
- 4) Construct a basin large enough to contain all liquid and waste concrete materials generated during washout procedures. A minimum basin size is 9 feet x 9 feet and 2 feet deep. Plastic liner materials shall be a minimum of 60-mil polyethylene sheeting free of holes and defects.
- 5) Recycle washout by pumping back into mixers for reuse when possible.

BMP MAINTENANCE

- ✓ The concrete washout should be checked frequently to ensure proper use and effectiveness.
- ✓ At 75% capacity, the washout must be cleaned or new facilities must be constructed and ready for use.

BMP REMOVAL

- ✓ The hardened concrete and materials related to the washout must be broken up, removed, and disposed of in accordance to local regulations.
- ✓ Area disturbed by the concrete washout must be repaired.

REFERENCES AND ADDITIONAL INFORMATION

California Regional Water Quality Control Board. *Erosion and Sediment Control Field Manual*, page 108, Third Edition, July 1999.

Caltrans. *Storm Water Quality Handbooks: Construction Site Best Management Practices Manual*, November 2000.



Source:
California Regional Water Quality Control
Board. Erosion and Sediment Control Field
Manual, Third Edition, July 1999.

**CONCRETE
WASHOUT**

BMP- CONTAINMENT OF CONCRETE POURS

DESCRIPTION

Proper management and techniques of pavement construction materials will greatly reduce or eliminate discharge into waterways resulting from paving, surfacing and the materials related to the removal of paving waste. Concrete and cement-related materials are toxic to fish and the aquatic environment.

APPLICATIONS

Containment of concrete will be necessary when forming, cutting, surfacing, paving, cleaning, or removal activities occur.

LIMITATIONS

- 6) Fine particulate matter may not be removed by the filtering methods.
- 7) Some containment controls become ineffective during wet weather.

CONSTRUCTION GUIDELINES

- 1) Apply concrete in dry weather to prevent runoff.
- 2) Drip pans or absorbent materials should be placed under paving machines when parked or stored on site.
- 3) Straw bales, sand bags, silt mats, or other controls should be used in drainage areas to filter runoff.
- 4) Use as little water as possible to reduce runoff.
- 5) Sweepings should be returned to the stockpile or disposed of in the trash, not washed into the street or a waterway.
- 6) Recycle broken concrete and asphalt.

BMP MAINTENANCE

- ✓ Check filter areas to ensure effective control of concrete waste. Remove waste build-up before filters are filled to capacity.
- ✓ Inspect and maintain machinery to minimize leaks and drips.
- ✓ Check with employees and subcontractors to ensure that measures are being followed.

BMP REMOVAL

- ✓ Drip pans, absorbent materials, wash water, and solids must be disposed of at approved facilities.

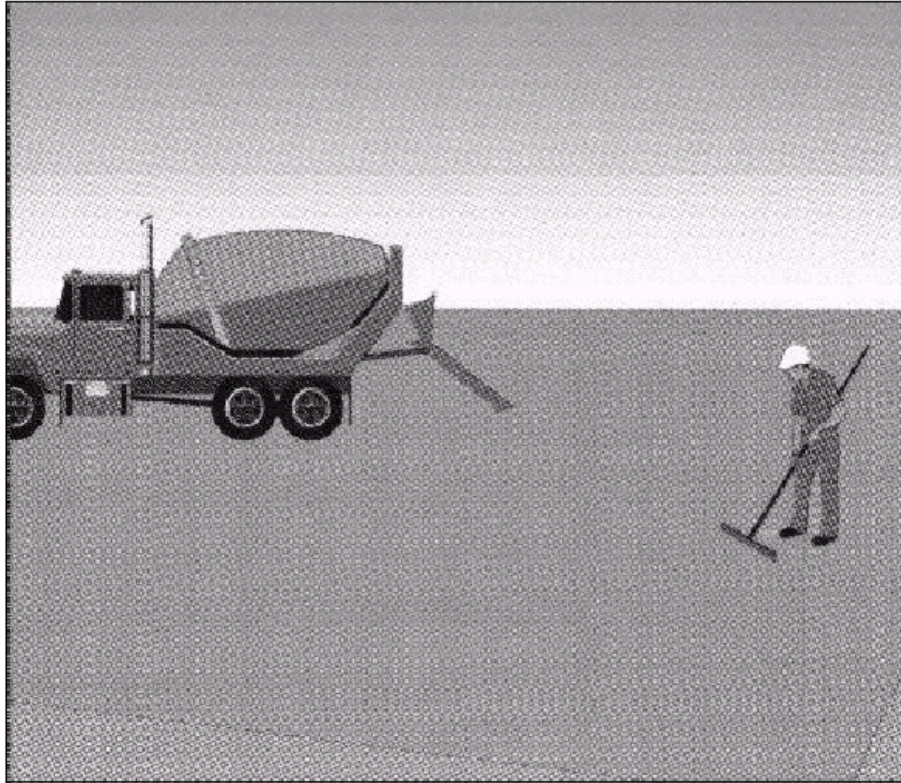

Source:
California Regional Water Quality Control
Board. Erosion and Sediment Control Field
Manual, Third Edition, July 1999.

CONTAINMENT, CONCRETE POUR

BMP – SILT MAT INLET

DESCRIPTION

A silt mat inlet protector is a filter fabric with an erosion control blanket and riser placed over a storm drain drop inlet to help reduce the introduction of sediment into the watercourse during construction.

APPLICATIONS

During construction, silt mats are the last line of defense to trap sediment before runoff enters the storm drain.

LIMITATIONS

- ✓ The silt mat inlet protection is only effective at low flows.
- ✓ Only effective for drop inlets which have been designed in a concave area – not for use on street side curb gutters.
- ✓ Inlet filters may cause stormwater to by-pass the inlet only to re-enter the watercourse at an unprotected location.
- ✓ Silt mat inlet protection must be monitored and maintained frequently.

CONSTRUCTION GUIDELINES

- 1) All upstream erosion control measures must be in place prior to installation of silt mat.
- 2) Clear and smooth the area to be covered by the erosion control blanket.
- 3) Roll out the blanket over the cleared area. Secure the edges of the blanket with staples or washed angular gravel.
- 4) Install the inlet protection device to the blanket as shown in the attached manufacturer's details.

BMP MAINTENANCE

- ✓ Filter maintenance requirements vary with the application. Silt mats should be inspected before and after every rain event.
- ✓ During extended periods of rainfall, inspection should be at least every 24 hours.
- ✓ Silt and debris should be removed when the depth exceeds three inches (3") and disposed of in accordance with local agency requirements.

- ✓ The silt mat should be replaced when ripped or damaged.

BMP REMOVAL

- ✓ Silt mat can be removed when no longer necessary for inlet protection. All materials should be disposed of properly.

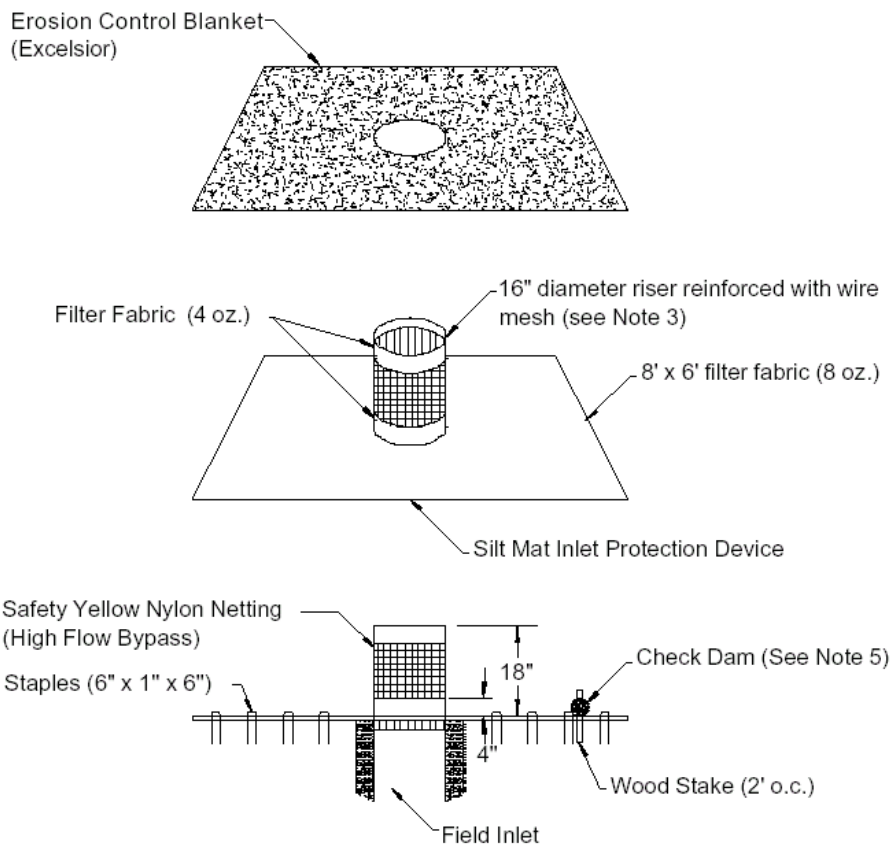

NOTES:

1. Clear and level area (6'-0" x 8'-0" min.) surrounding field inlet.
2. Roll out mat and center riser over inlet grate.
3. Install wire mesh frame into riser.
4. Secure mat in place using staples (6" x 1" x 6" min.) at approximately 1'-0" o.c.e.w. On hard surfaces, anchor with washed angular gravel or rock.
5. Side(s) of erosion control blanket may be rolled to form check (silt) dam to further slow or direct flows. Stake in place as shown.
6. Inspect inlet protection device before and after rain events, and weekly throughout the rainy season. During extended rain events, inspect at least once every 24 hours.
7. Remove and properly dispose of accumulated silt and debris to allow for proper function of device.

Source:
www.kristar.com/media/pdf/siltmat.pdf
 KriStar Enterprises, Inc., Santa Rosa, CA
 (800) 579-8819

SILT MAT - INLET

BMP – SILT MAT/VEGETATED GRASSY SWALE

DESCRIPTION

An erosion control blanket installed in a swale or drainage ditches and outlets at construction sites, functioning to both prevent erosion and collect water-borne sediments. The mat maybe seeded to establish vegetation which aides in sediment entrapment.

APPLICATIONS

A last line of defense to trap sediments before construction site waters enter the natural watercourse.

LIMITATIONS

- ✓ Not for large volumes or high flows – swale slope must be low gradient.
- ✓ Plastic netted erosion control blankets may entrap wildlife. Use plastic-netted erosion control blankets only when the design shear stress exceeds the manufacturer's recommendations for non-plastic products and wildlife entrapment will not be an issue.

CONSTRUCTION GUIDELINES

- 5) All upstream erosion control measures must be in place prior to installation of silt mat.
- 6) Where installation is downstream of a discharge point such as a culvert or discharge hose, a rock energy dissipater will be required over a portion of the silt mat.
- 7) There are many types and grades of erosion control blanket. The blanket chosen should be non-plastic, consisting of natural fibers such as coir or excelsior. The blanket must meet the manufacturer's design specifications for the flow rates, velocities, and shear stresses anticipated.
- 8) Install as per manufacturer's instructions. See accompanying details. It is essential that pre-installation soil surfaces are smooth to provide good soil to silt mat contact without tenting.
- 9) If used with an appropriate perennial seed mix, the effectiveness of the silt mat may increase as the grass grows. (see Broadcast Seeding BMP)
- 10) Do not use fertilizers in conjunction with the silt mat and seeding, as the fertilizer may mobilize and contaminate downstream waters.

BMP MAINTENANCE

- ✓ Inspect silt mat during and after flow events. Re-fasten any loose areas, or replace damaged sections.

BMP REMOVAL

- ✓ Removal may not be required as the natural materials decompose on site.

SILT MAT- SWALE

Purpose: To capture sediment and prevent erosion at culvert discharge points where there are no high flow rates.

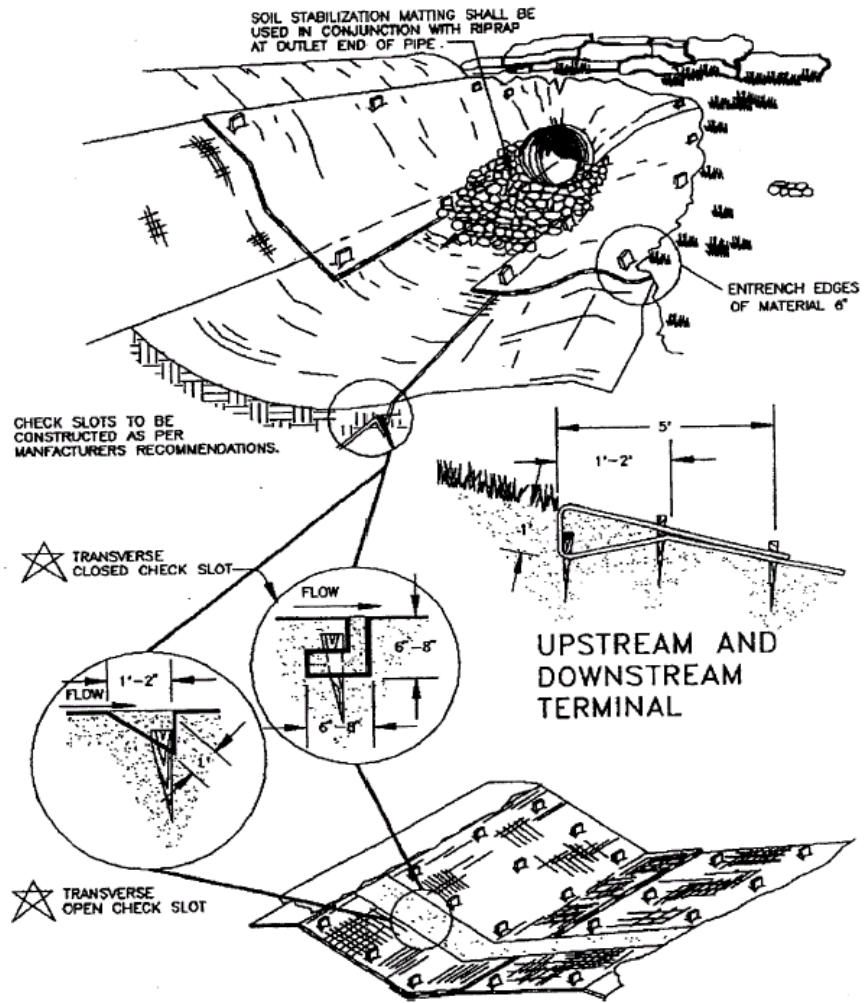

Source: King County. 2000. Regional Road Maintenance Endangered Species Act Program Guidelines.

BMP- SILT FENCE

DESCRIPTION

A silt fence is a temporary sediment barrier consisting of filter fabric entrenched into the soil and attached to supporting posts. Silt fence installed with a trencher or by slicing is the most effective installation method to ensure against common silt fence failures.

The slicing method for silt fence installation utilizes an implement towed behind a tractor to “plow” or slice the silt fence material into the soil. The slicing method requires the “Tommy” silt fence machine or equivalent. Silt fence machines install the silt fence by slicing through the soil, rather than excavating it. Slicing minimally disrupts the soil upward and slightly displaces the soil, maintaining the soil’s profile and creating an optimal condition for future mechanical compaction. Compacted soil resists water infiltration and moisture saturation, thus nearly eliminating washouts.

APPLICATIONS

Silt fence is a sediment control practice. Silt fence is intended to be installed where sediment-laden water can pond, thus allowing the sediment to fall out of suspension and separate from the runoff. It is not intended to be an erosion control practice. Improperly applied or installed silt fence will increase erosion. Only install silt fence where water can pond. Silt fence placed off contour will effectively divert runoff if that is desired.

Silt fence can be used where:

- ✓ sheet and rill erosion would occur;
- ✓ protection of adjacent property or areas beyond the limits of grading is needed (perimeter control);
- ✓ the size of the drainage area is no more than 1/4 acre per 100 linear feet of silt fence;
- ✓ the maximum flow path length above the barrier is 100 feet (30.5 m);
- ✓ the maximum slope gradient above the barrier is 2:1;
- ✓ small swales are carrying silt, the slope is less than 2%, and the drainage area is less than 2 acres (0.8 ha);
- ✓ silt fence is the only feasible option.

LIMITATIONS

The high failure rate of silt fences is often due to:

- ✓ Improper placement on the site
- ✓ Inadequate quantities relative to the area contained
- ✓ Shallow trenches with little or no soil compaction.
- ✓ Inadequate attachment to posts
- ✓ Failure to maintain the silt fence after installation.

When installing, remember these important facts:

- ✓ No formal design is required. Silt fences have a useful life of one season. Their principal mode of action is to slow and pond the water and allow soil particles to settle. Silt fences are not designed to withstand high heads of water, and therefore should be located where only shallow pools can form. Their use is limited to situations in which sheet or overland flows are expected.
- ✓ Silt fences should be placed on contour to be most effective. Site perimeters and property boundaries rarely follow slope contour. If silt fences are placed along property boundaries, water may be diverted to the low point and failure may occur.
- ✓ The slicing method has the capability to turn in a short distance, thus properly installing silt fence where needed. Turning enables upturns on the ends of silt fence runs, maneuvering around obstacles on construction sites, protection along property lines, and following contours as prescribed in Best Management Practices.
- ✓ Silt fences normally cannot filter the volumes generated by channel flows. When installed across a concentrated flow path, undercutting of the fence often occurs. Silt fences should not be designed to impound sediment or water more than 18 inches (0.5 m) high. Sediment shall be cleaned from behind the fence when it reaches 50% of the designed impoundment height (9 inch (0.2 m)).

CONSTRUCTION GUIDELINES

Some design considerations include:

- 1) Determine what kind of runoff, and how much, is coming onto the site; too much volume of water per silt fence area means failure will happen;
- 11) Determine where and how the total volume is going to exit; total drainage area is the prime consideration of silt fence quantity, not necessarily slope;

- 12) Soil type can play a role in the placement and quantity requirements; sandy soils might require more silt fence per area to contain the volume of potential sediment; clay soils might need fewer fences because the volume of potential sediment loss is less, although the volume of water might be greater because clay soils allow less rainfall infiltration;
- 13) Type, size and spacing of fence posts; wood posts are inadequate and should not be used; steel t-posts weighing at least 1.25 lbs per ft. are required, as they can be driven 24 inches into compacted soil, which is necessary to hold a horizontal load 18 inches high, and they can also be recycled and used repetitively; improper spacing of posts causes failures;
- 14) Type of filter cloth; if all the elements of the silt fence installation are properly adhered to, the fabric does not make much difference; even lightweight non-woven fabric will hold 18 inches of sediment; wire supported fence is costly and ineffective.
- 15) Typical silt fence specifications were written 25 years ago and have changed little since. Some states have recognized some of the inherent problems, such as inadequate trench depth, and implemented minor changes to improve efficacy. The 25 year-old specifications, referred to as the trenching method, have never been tested for efficacy and proven worthwhile. A trencher was simply the only piece of equipment available at the time capable of securing the fabric into the soil, regardless of efficacy. Today, many contractors just open a furrow with a blade and backfill onto the fabric with the crumbs. Loose soil, both from the trencher or the blade, absorbs water quickly and becomes saturated easily, washing out under the fabric.
- 16) The soil should be sliced and the fabric mechanically installed into the soil
- 17) The height of a silt fence shall not exceed 36 inches (0.9 m). Storage height and ponding height shall never exceed 18 inches (0.5 m).
- 18) To minimize erosion, install silt fence at the head of a slope to slow velocity and to create a large storage area.
- 19) The fence line shall follow the contour as closely as possible.
- 20) The ends of the fence should be turned uphill.
- 21) Steel support posts should be utilized, properly spaced and driven into compacted soil
- 22) Post spacing shall not exceed 6 feet (1.8 m).
- 23) The filter fabric is stapled or wired directly to the posts. Filter fabric shall not be stapled to existing trees.

- 24) Fabric should be attached to the posts with three diagonal ties
- 25) Set any silt fence placed at the toe of a slope at least 6 feet (1.8 m) from the toe in order to increase ponding volume.

BMP MAINTENANCE

- ✓ Inspect silt fences and filter barriers weekly after each significant storm, i.e. 1 inch (25.4 mm) in 24 hours. Make any required repairs immediately.
- ✓ Remove sediment when it reaches 1/3 height of the fence or 9 inches (0.3 m) maximum.
- ✓ The removed sediment shall conform to the existing grade and be vegetated or otherwise stabilized.

BMP REMOVAL

- ✓ Once a silt fence has served its purpose, make sure you permanently stabilize the upslope area and remove any sediment stored behind the silt fence *before* removing it.

ADDITIONAL RESOURCES

Silt Fence That Works, Thomas Carpenter, CPESC, 2000. Tommy Silt Fence Machine, 3718 S.W. Court Ave., Ankeny, Iowa, 50021 (800) 965-4665 www.tommy-sfm.com
Installation of Silt Fence Using the Tommy® Static Slicing Method, Environmental Technology Verification Report, Washington, DC, 2000

J-HOOKS OR 'SMILES' ARE PREFERABLE TO LINEAR INSTALLATION

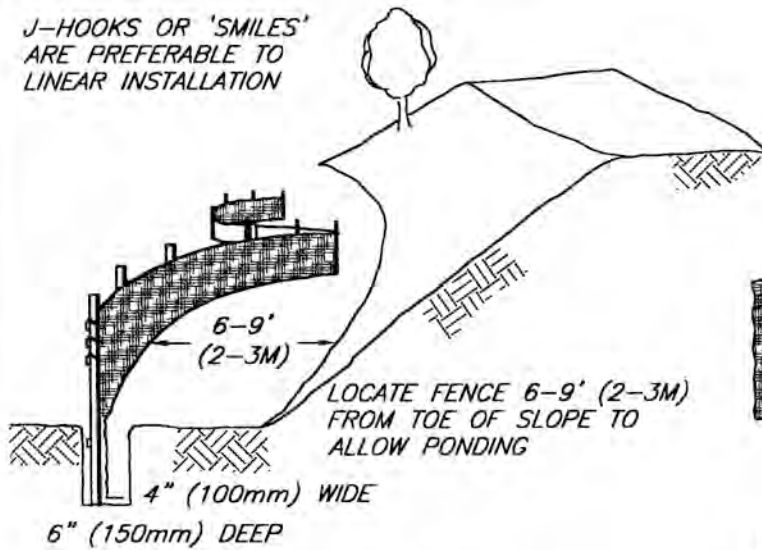

LOCATE FENCE 6-9' (2-3M) FROM TOE OF SLOPE TO ALLOW PONDING

'BEST' TRENCHING METHOD

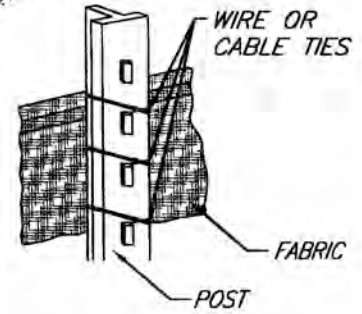

'BEST' T-POST WITH ATTACHMENT TO POST

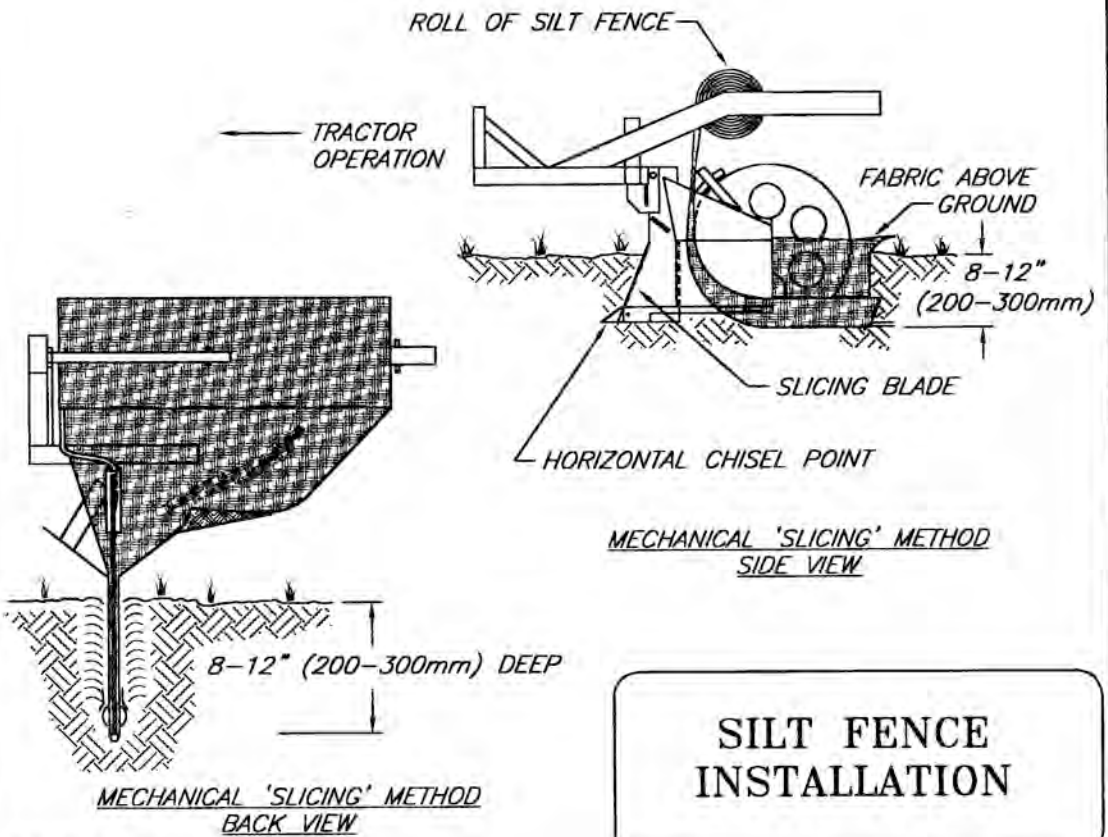

MECHANICAL 'SLICING' METHOD SIDE VIEW

MECHANICAL 'SLICING' METHOD BACK VIEW

SILT FENCE INSTALLATION

FILE: SF-Methods

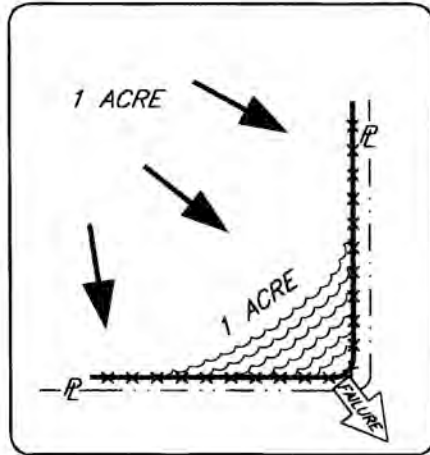

Incorrect – *Do Not* layout "perimeter control" silt fences along property lines. All sediment laden runoff will concentrate and overwhelm the system.

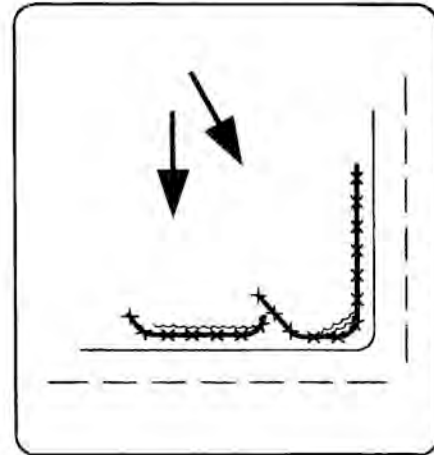

Correct – Install J-hooks

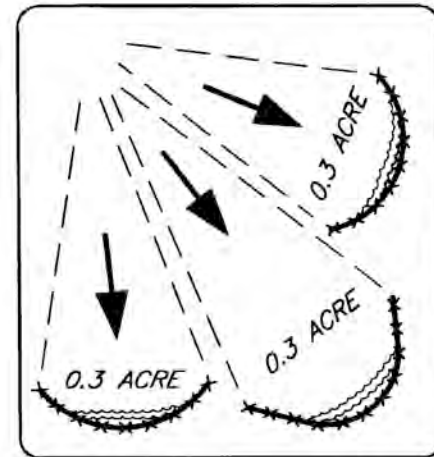
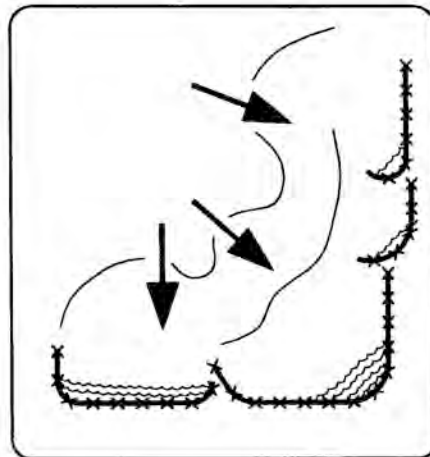

Discreet segments of silt fence, installed with J-hooks or 'smiles' will be much more effective.

SILT FENCE PLACEMENT FOR PERIMETER CONTROL

FILE: SF-Perimeter Control

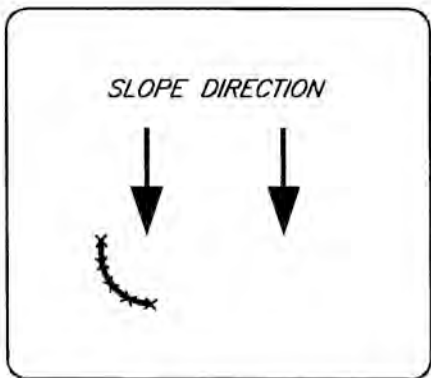
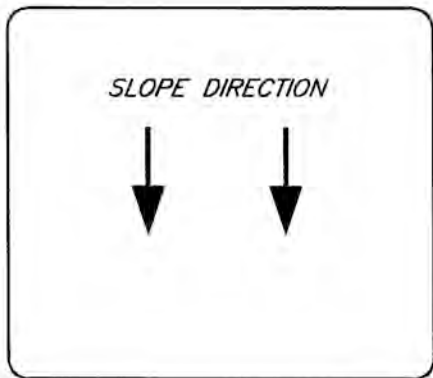

STEP 1 – CONSTRUCT LEG

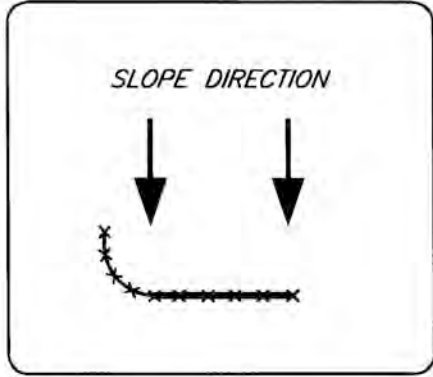

STEP 2 – CONSTRUCT DAM

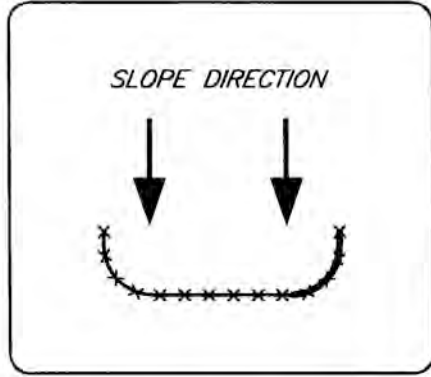

STEP 3 – CONSTRUCT LEG 2

INSTALLATION WITH J-HOOKS OR 'SMILES' INCREASE SILT FENCE EFFICIENCY.

**SILT FENCE
TYPICAL PLACEMENT—ONE SLOPE**

FILE: SF-One Slope

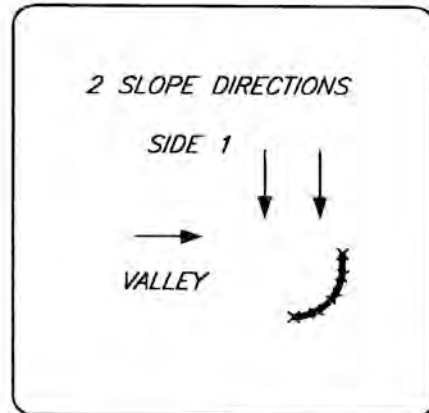
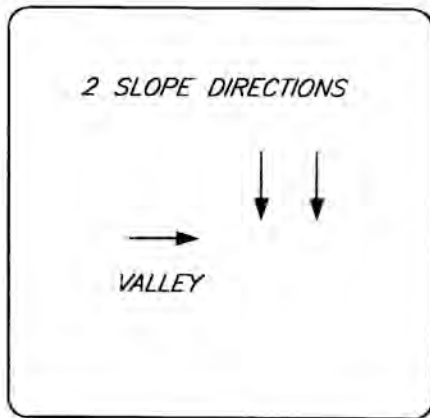

STEP 1 - CONSTRUCT A DAM

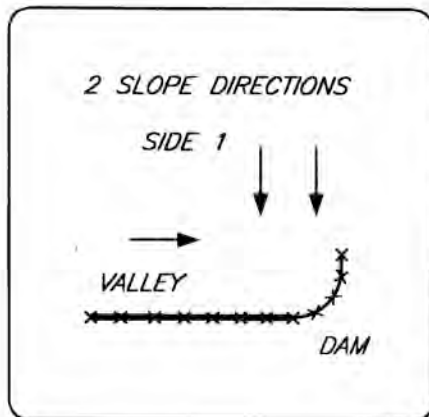

STEP 2 - CONSTRUCT SIDE 2

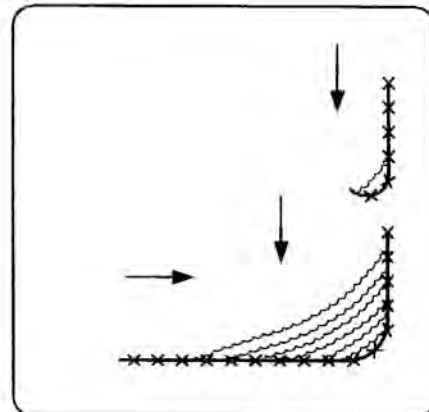

STEP 3 - CONSTRUCT J-HOOKS AS NEEDED

INSTALLATION WITH J-HOOKS WILL INCREASE SILT FENCE EFFICIENCY AND REDUCE EROSION-CAUSING FAILURES.

SILT FENCE TYPICAL PLACEMENT-TWO SLOPES

FILE: SF-Two Slopes

BMP – SEDIMENT TRAP OR SUMP

DESCRIPTION

A sediment sump (also known as a sediment trap) is a small basin with a controlled release structure. The basin is formed by excavating or by constructing an earthen embankment, straw bale check dam, or gravel bag barrier across the drainage path. The trap is used only to retain larger size sediment and should only be used in conjunction with upstream erosion control measures and downstream sediment controls.

APPLICATIONS

Sediment traps may be used during wet construction periods for small drainages of less than 5 acres where sediment-laden storm water may enter the storm drain system or watercourse. See also BMP – Siltation Pond.

LIMITATIONS

- ✓ Requires an area large enough to settle water.
- ✓ Not appropriate for drainage areas greater than 5 acres or within fish bearing streams.
- ✓ Removes only larger materials (not excessive fines) and must be used in conjunction with other erosion control methods.
- ✓ May require safety fencing to keep people out.
- ✓ Not to be used in a live stream.
- ✓ Location must be approved by appropriate agencies to avoid unintended impacts to wetlands or other key habitats.

CONSTRUCTION GUIDELINES

- 1) Sediment traps should be constructed prior to rainy season and construction activities.
- 2) Trap shall be located: 1) by excavating a suitable area or where a low embankment can be constructed across a swale, 2) where failure would not cause loss of life or property damage, and 3) to provide access for maintenance, including sediment removal and sediment stockpiling in a protected area.
- 3) Trap shall be sized to accommodate a settling zone and sediment storage zone with recommended minimum volumes of 67 cubic yards/acre and 33 cubic yards/acre of contributing drainage area, respectively, based on 0.5 inches of runoff volume over a 24 hour period. Multiple traps and/or additional volume may be required to accommodate site specific rainfall and soil conditions.

- 4) Traps with an impounding levee greater than 4.5 feet tall, measured from the lowest point to the impounding area to the highest point of the levee, and traps capable of impounding more than 1300 cubic yards, shall be designed by a professional Civil Engineer registered with the state of California.
- 5) Areas under embankments, structural work, and sediment traps shall be cleared and stripped of vegetation.
- 6) Trap length to width ratio shall be greater than 3:1 (L:W) or baffles are required to prevent short circuiting of the inlet flow.
- 7) Trap inlets shall be located to maximize the travel distance to the trap outlet. Use rock or vegetation to protect the trap outlets against erosion.
- 8) To dewater the trap, the outlet shall be constructed in one of the following two ways: 1) Use corrugated metal, high density polyethylene (HDPE), or reinforced concrete riser pipe with dewatering holes encased in gravel to prevent floating debris from flowing out of the trap or obstructing the system; or 2) Construct a crushed stone outlet section of the embankment at the low point of the trap. The stone section serves as a non-erosive spillway outlet for flood flows and the bottom section provides a means of dewatering the trap between rainfall events.

BMP MAINTENANCE

- ✓ Inspect sediment traps before and after rainfall events and weekly during the rest of the rainy season. During extended rainfall events, inspect sediment traps at least every 24 hours.
- ✓ Check trap banks for seepage and structural soundness.
- ✓ Check outlet structure and spillway for any damage or obstructions. Repair damage and remove obstructions as needed.
- ✓ Check outlet area for erosion and stabilize if required.
- ✓ Remove accumulated sediment when the volume has reached one-third the original trap volume.
- ✓ Properly dispose of sediment and debris removed from trap.
- ✓ Check fencing for damage and repair as needed.

BMP REMOVAL

- ✓ Once site has stabilized, remove dam structure, re-grade to original contours, mildly compact if fill is placed, seed and mulch, or otherwise stabilize areas of bare soil.
- ✓ Dispose of imported fill material in approved stable areas away from watercourses.

✓ Pdf of sediment sump and trap

BMP – SILTATION POND/SETTLING POND

DESCRIPTION

A siltation pond or desilting basin is a temporary basin formed by excavating and/or constructing an embankment so that sediment-laden runoff is temporarily detained under quiescent conditions, allowing sediment to settle out before the runoff is discharged. It is a last line of defense to prevent sediment from entering a watercourse after all other pertinent upslope erosion control measures have been installed.

APPLICATIONS

Desilting basins can be used on large construction projects with disturbed areas during the rainy season, and where sediment laden water may enter the drainage system or watercourses, or at outlets of disturbed soil with areas between 5-10 acres.

LIMITATIONS

- ✓ All erosion control BMPs must be in place to minimize amount of sediment entering the basin.
- ✓ Requires large surface area to permit settling of sediment.
- ✓ Not appropriate for areas greater than 30 ha (75 acres).
- ✓ Not to be located in live fish bearing streams.
- ✓ If safety is a concern, basins may require protective fencing.

CONSTRUCTION GUIDELINES

- 1) Limit the contributing area to the desilting basin to only runoff from the disturbed soil areas. Use temporary concentrated flow conveyance controls to divert runoff from undisturbed areas away from the desilting basin.
- 2) Desilting basins shall be designed to have a capacity equivalent to 100 cubic meters of storage (as measured from the top of the basin to the principal outlet) per hectare of contributory area. This design is less than the required size to capture the 0.01 mm particle size but larger than that required to capture particles 0.02 mm or larger.
- 3) The length of the basin shall be more than twice the width of the basin; the length shall be determined by measuring the distance between the inlet and the outlet.
- 4) The depth must be no less than one (1) meter nor greater than 1.5 m.
- 5) Basins with an impounding levee greater than 1.5 m tall, measured from the lowest point to the impounding area to the highest point of the levee, and basins

- capable of impounding more than 1000 cubic meters shall be designed by a professional Civil Engineer registered with the state of California.
- 6) Design and locate desilting basins so that they can be maintained (cleaned out). Construct desilting basins prior to the rainy season and construction activities.
 - 7) Desilting basins, regardless of size and storage volume, shall include features to accommodate overflow or bypass flows that exceed the design storm event.
 - 8) Basins shall be designed to drain within 72 hours following storm events.
 - 9) The outflow from the desilting basin shall be provided with outlet protection to prevent erosion and scouring of the embankment and channel.
 - 10) Basin shall be located: 1) by excavating a suitable area or where a low embankment can be constructed across a swale, 2) where post-construction (permanent) detention basins will be constructed, 3) where failure would not cause the loss of life or property damage, and 4) where the basins can be maintained on a year-round basis to provide access for maintenance, including sediment removal and sediment stockpiling in a protected area, and to maintain the basin to provide the required capacity.
 - 11) Areas under embankments, structural work, and sediment traps shall be cleared and stripped of vegetation.
 - 12) Basin inlets shall be located to maximize water travel distance to the basin outlet.
 - 13) Rock or vegetation shall be used to protect the basin inlet and slopes against erosion.
 - 14) A forebay, constructed upstream of the basin, may be provided to remove debris and larger particles.
 - 15) Principal outlet shall consist of a corrugated metal, high density polyethylene (HDPE), or reinforced concrete riser pipe with dewatering holes and an anti-vortex device and trash rack attached to the top of the riser to prevent floating debris from flowing out of the basin or obstructing the system. This principal structure shall be designed to accommodate the inflow design storm.
 - 16) Structure shall be placed on a firm, smooth foundation with the base securely anchored with concrete or other means to prevent floatation.
 - 17) Attach riser pipe (watertight connection) to a horizontal pipe (barrel) which extends through the embankment to toe of fill. Provide anti-seep collars on the barrel.
 - 18) Cleanout level shall be clearly marked on the riser pipe.
 - 19) Avoid dewatering of groundwater to the desilting basin during the rainy season. Insignificant quantities of accumulated precipitation may be dewatered to the desilting basin unless precipitation is forecasted within 24 hours.
 - 20) Area may require fencing if safety is a concern.
 - 21) One of the dewatering configurations shown below for the principal outlet may be used. The Contractor shall verify that the outlet is properly designed to handle the design and peak flows.
 - 22) Outlet #1 (see drawing): Perforate the top one-third of the riser with 13 mm (0.5 in) diameter holes spaced 200 mm (8 in) vertically and 250 mm (10 in) -300 mm (12 in) horizontally. Place 19 mm (0.75 in) gravel over perforated holes to approximately 50 mm (2 in) minimum thickness to assist in prevention of

clogging of dewatering holes. Gravel will naturally settle into a cone surrounding the riser pipe.

- 23) Outlet #2 (see drawing): Perforate the lower one-half of the riser pipe with 13 mm (0.5 in) diameter holes spaced approximately 75 mm (3 in) apart, in each outside valley (corrugated metal pipe). Place 19 mm (0.75 in) gravel over perforated holes to approximately 50 mm (2 in) minimum thickness to assist in prevention of clogging of dewatering holes. Gravel will naturally settle into a cone surrounding the riser pipe.
- 24) Outlet #3 (see drawing): Provide two 25 mm (1 in) diameter holes above the sediment storage volume on opposite sides of the non-perforated riser pipe. This will typically provide sufficient detention time for basins to drain approximately 4 ha (10 ac). Construct an emergency spillway to accommodate flows not carried by the principal spillway. Spillway shall consist of an open channel (earthen or vegetated) over undisturbed material (not fill) or constructed of a non-erodible riprap. Spillway control section, which is a level portion of the spillway channel at the highest elevation in the channel, shall be a minimum of 6 m (20 ft) in length. Use outlet protection at the pipe outlet.

BMP MAINTENANCE

- ✓ Inspect temporary desilting basins before and after rainfall events and weekly during the rest of the rainy season. During extended rainfall events, inspect sediment traps at least every 24 hours.
- ✓ Examine basin banks for seepage and structural soundness.
- ✓ Check inlet and outlet structures and spillway for any damage or obstructions. Repair damage and remove obstructions as needed.
- ✓ Check inlet and outlet areas for erosion and stabilize if required.
- ✓ Remove sediments when storage zone is one-third full.
- ✓ Properly dispose of sediment and debris removed from trap.
- ✓ Check fencing for damage and repair as needed.

BMP REMOVAL

- ✓ Re-grade dam and basin area to original slope unless another configuration is specified.
- ✓ Stabilize areas of bare soil with seed and mulch prior to the rainy season.

SOURCE

Caltrans. Storm Water Quality Handbooks: Construction Site Best Management Practices Manual, page SC-2, November 2000.

Pdf page 1 of siltation pond

Pdf of siltation pond page 2

Pdf siltation pond page 3

BMP – STORM DRAIN INLET PROTECTION

DESCRIPTION

Curb inlet sediment barriers on storm drains are temporary barriers constructed from concrete block and gravel or gravel filled sandbags.

APPLICATIONS

Curb inlet sediment barriers reduce the sediment discharged into storm drains by ponding the runoff and allowing the sediment to settle out. The structures allow for overflow from high runoff events and the gravel allows the ponds to dewater rapidly. Use this BMP where new construction, reconstruction and/or private development is generating sediment or polluted runoff.

LIMITATIONS

- ✓ Do *not* use this BMP on steep sloping streets.
- ✓ Consider this BMP a “backup,” used *in addition to* controlling potential erosion at the source.

CONSTRUCTION GUIDELINES

- 1) Place the barriers on gently sloping streets where water can pond.
- 2) The barriers must allow for overflow from a severe storm event. A spillway shall be constructed with the sandbag structures to allow overflow.
- 3) Sandbags shall be filled with 3/4-inch drain rock or 1/4-inch pea gravel.
- 4) The sandbags shall be placed in a curved row from the top of curb at least 3 feet into the street. The row should be curved at the ends, pointing uphill.
- 5) Several layers of bags should be overlapped and packed tightly.
- 6) Leave a one-sandbag gap in the top row to act as a spillway.

BMP MAINTENANCE

- ✓ Inspect and clean barrier during and after each significant storm and remove sediment from behind sandbag structure after every storm.
- ✓ Any sediment and gravel shall be immediately removed from the traveled way of roads.

- ✓ The removed sediment shall be placed where it cannot enter a storm drain, stream, or be transported off site.
- ✓ If the gravel becomes clogged with sediment, it must be carefully removed from the inlet and either cleared or replaced.

BMP REMOVAL

- ✓ BMP removal should not be necessary.

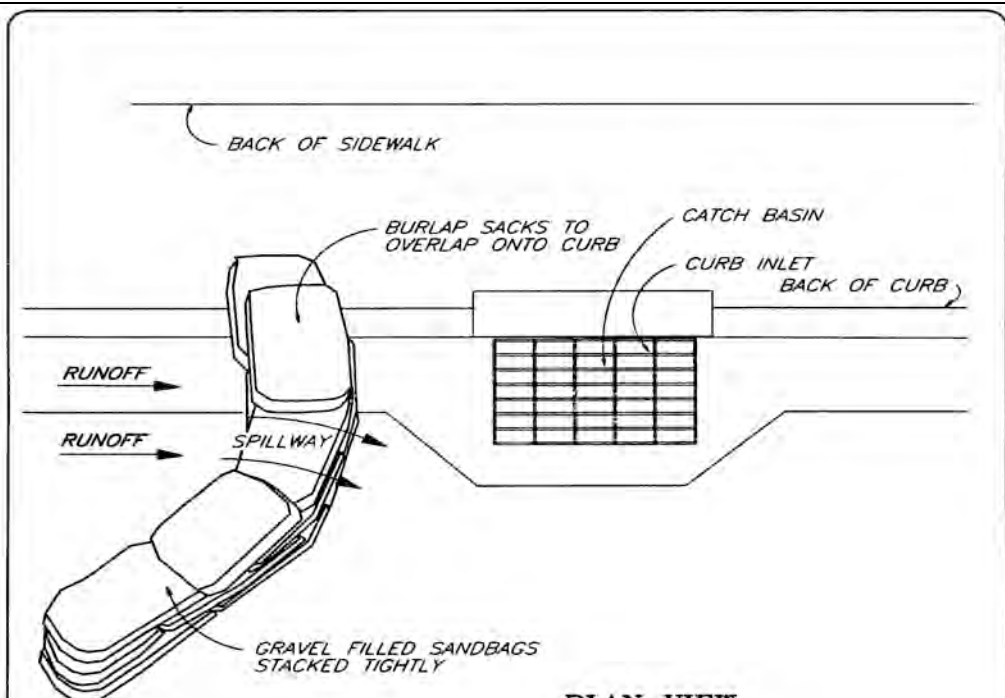

PLAN VIEW

NOTES:

1. PLACE CURB TYPE SEDIMENT BARRIERS ON GENTLY SLOPING STREET SEGMENTS, WHERE WATER CAN POND AND ALLOW SEDIMENT TO SEPARATE FROM RUNOFF.
2. SANDBAGS OF EITHER BURLAP OR WOVEN 'GEOTEXTILE' FABRIC, ARE FILLED WITH GRAVEL, LAYERED AND PACKED TIGHTLY.
3. LEAVE A ONE SANDBAG GAP IN THE TOP ROW TO PROVIDE A SPILLWAY FOR OVERFLOW.
4. INSPECT BARRIERS AND REMOVE SEDIMENT AFTER EACH STORM EVENT. SEDIMENT AND GRAVEL MUST BE REMOVED FROM THE TRAVELED WAY IMMEDIATELY.

**CURB AND GUTTER
SEDIMENT
BARRIER**

© 1994 JOHN McCULLAH

FILE: CURBGTR

BMP – SWEEPING

DESCRIPTION

Sweeping performed by hand or mechanical means is an effective way to clean debris and reduce the possibility for runoff into storm drains, watercourses, and streams.

APPLICATIONS

Sweeping is preferred to the use of water to clean up soil particles and debris. Use sweeping to help suppress dust on roadways and at construction sites. Sweeping and vacuuming are suitable anywhere sediment is tracked from the project site onto public or private paved streets and roads, typically at points of egress.

LIMITATIONS

- ✓ Some dust particles may become air-born.
- ✓ May not be effective when sediment is wet or when tracked soil is caked (caked soil may need to be scraped loose).

CONSTRUCTION GUIDELINES

- 1) To prevent inhalation of dust and fine sediment, use respiratory protection.
- 2) Controlling the number of points where vehicles can leave the site will allow sweeping and vacuuming efforts to be more focused and effective.
- 3) Collect waste and dispose of at permitted facilities. If material is not mixed with debris or trash, consider incorporating the removed sediment back into the project.
- 4) Use a minimum amount of water with mechanical brooms.
- 5) Do not pick up suspicious debris but instead call the appropriate agency or HazMat contractor.

BMP MAINTENANCE

- ✓ Keep brooms and sweeping machinery in good condition. Repair any leaks.
- ✓ Inspect potential sediment tracking locations daily.

BMP REMOVAL

- ✓ Collect waste frequently and dispose properly.



Source:
California Regional Water Quality Control
Board. Erosion and Sediment Control Field
Manual, Third Edition, July 1999.

SWEEPING

BMP – TURBIDITY CURTAIN

DESCRIPTION

A turbidity curtain is a temporary floating geotextile structure used to contain the flow of silt and debris in a waterway during construction. The curtain functions by limiting the flow of water to allow the sediments to settle out. **Other names:** floating boom, turbidity barrier, silt curtain, stillwater screen.

APPLICATIONS

Silt and debris must be contained by law to protect aquatic resources. The turbidity curtain can be ordered to specification depending on flow, depth, length, filtering properties, and the desired length of deployment.

LIMITATIONS

- ✓ Use of a turbidity curtain in a waterway is subject to federal, state, and local permits.
- ✓ The curtain is intended to be used as an enclosure, not a dam for turbid waters to settle out.
- ✓ Custom curtains are available.
- ✓ A site survey is required to assess the velocity, depth, and sediment type to select the proper curtain.

CONSTRUCTION GUIDELINES

- 1) Construction of the turbidity curtain varies with vendor: see manufacturer's specifications.
- 2) Choose the appropriate height and length of turbidity curtain.
- 3) Add a suitable weight or anchoring system to the bottom of the curtain
- 4) Ensure that water discharged from turbidity curtain meets permit requirements at point of discharge.

BMP MAINTENANCE

- ✓ Careful monitoring of the mud levels will be required to conform to the curtain's capability to hold the material.
- ✓ Anchor lines must be checked and replaced with any signs of wear.
- ✓ Tears and leaking connections must be checked and repaired.

BMP REMOVAL

- ✓ Remove curtain in such a manner as to minimize turbidity. Remaining soil particles shall be sufficiently settled before removing the curtain.
- ✓ Discharge of turbid water will be subject to discharge requirements in waterways.

TURBIDITY CURTAIN

Figure 1. Turbidity Curtain – Type III, including tidal situation.

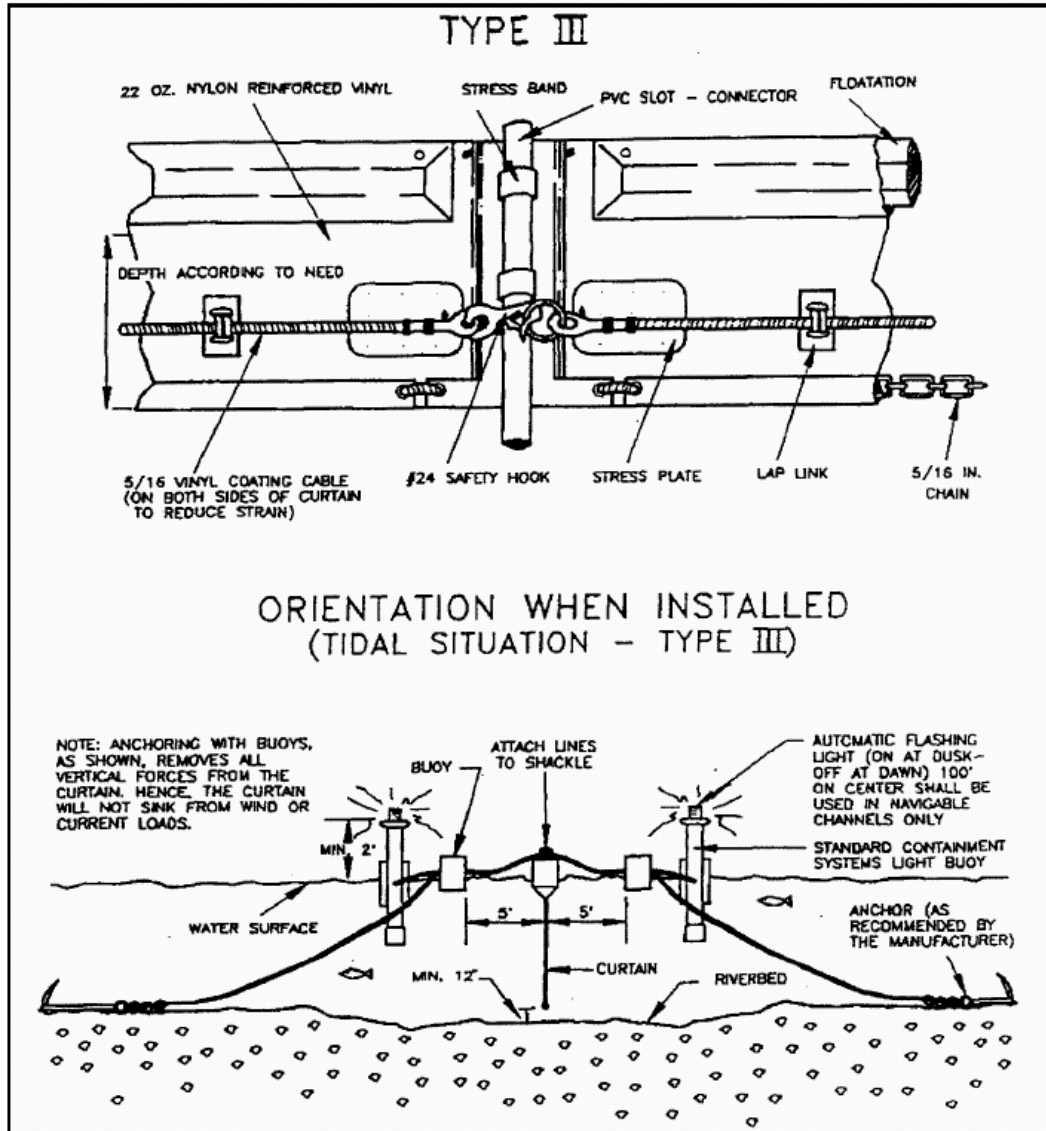

Source: King County. 2000. Regional Road Maintenance Endangered Species Act Program Guidelines.

TURBIDITY CURTAIN

Figure 2. Two typical layouts of a turbidity curtain.

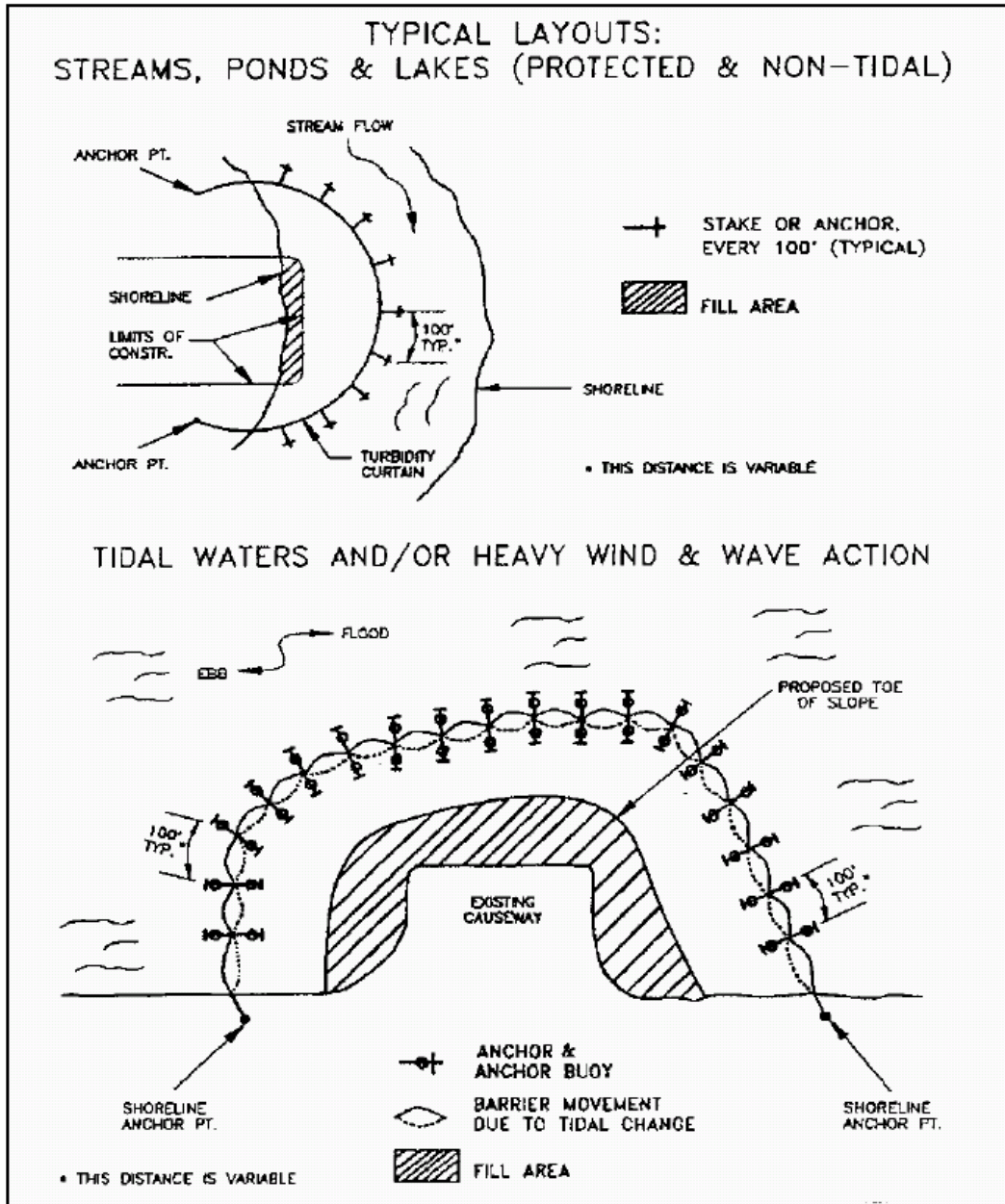

Source: King County, 2000. [Regional Road Maintenance Endangered Species Act Program Guidelines](#).

WATER MANAGEMENT BMPs

□ ASPHALT BERM.....	A-147
□ AQUA BARRIER	A-149
□ COFFERDAM.....	A-151
□ DEWATERING	A-157
□ DIVERSION BERM	A-161
□ FISH EXCLUSION	A-163
□ LEVEL SPREADER.....	A-165
□ SANDBAG.....	A-169
□ SLOPE DRAIN – TEMPORARY.....	A-171
□ SLOPE DRAIN – OVERSIDE.....	A-175
□ SLOPE DRAIN- SWALE	A-179
□ STREAM BYPASS (WATER DIVERSION)	A-181

BMP - ASPHALT BERM

DESCRIPTION

An asphalt berm is a ridge of asphalt concrete or “cutback” constructed at the top of a disturbed slope. The purpose of the BMP is to direct stormwater runoff away from an unstable slope.

APPLICATIONS

This BMP may be used wherever stormwater runoff must be diverted away from a disturbed slope and toward a sediment containment facility or stable runoff.

LIMITATIONS

Do *not* use this BMP:

- ✓ to concentrate runoff onto unstable, eroded areas.
- ✓ near edges of slides or streambanks where cutback berms could slip into a stream.

CONSTRUCTION GUIDELINES

- 1) Construct asphalt berm to the minimum height and width needed to divert runoff without adding unnecessary weight.
- 2) Asphalt berms may be striped or marked for traffic safety.
- 3) Asphalt berms may be used to anchor temporary plastic sheeting.

BMP MAINTENANCE

- ✓ Conduct periodic inspections, and repair berms as necessary.

BMP REMOVAL

- ✓ Asphalt berm removal may not be necessary, or may be conducted during permanent slope or streambank repair activities.
- ✓ Recycle or reuse asphalt berm material.

BMP – AQUA BARRIER

DESCRIPTION

Aqua barriers are temporary, re-usable water-filled plastic tubes installed as dams. An aqua barrier can be used as a type of coffer dam.

APPLICATIONS

Aqua barriers can be used in any situation where water damming, water diversion, or silt containment is necessary. The dams are portable, re-usable, and come in a variety of sizes to fit any project.

LIMITATIONS

- ✓ Use of aqua barriers in a waterway are subject to federal, state, and local permits.
- ✓ A portable pump and abundant local water supply must be available.
- ✓ Sharp objects will puncture the plastic.
- ✓ Not suitable for steep channel gradients.
- ✓ Presents a temporary barrier to migrating aquatic species.

CONSTRUCTION GUIDELINES

- 1) Instructions for aqua barriers vary by manufacturer; however they are generally put in place in the waterway then filled with water.
- 2) Although the barriers are flexible and conform to varied terrain, some smoothing and leveling of the ground surface may be needed.
- 3) Substrate beneath the barriers must be of sufficient strength and uniformity to support the load.
- 4) Safety issues regarding potential breach of dam must be addressed in the planning stages.
- 5) 25% minimum freeboard is required. More freeboard may be needed for slick or weak soils, or higher velocities over 3 feet per second.

BMP MAINTENANCE

- ✓ Aqua barriers should be checked routinely for tears and stability.

BMP REMOVAL

- ✓ Water released from the aqua barrier on-site may require additional measures to ensure environmental compliance.
- ✓ An energy dissipating device is required to prevent erosion from draining water.

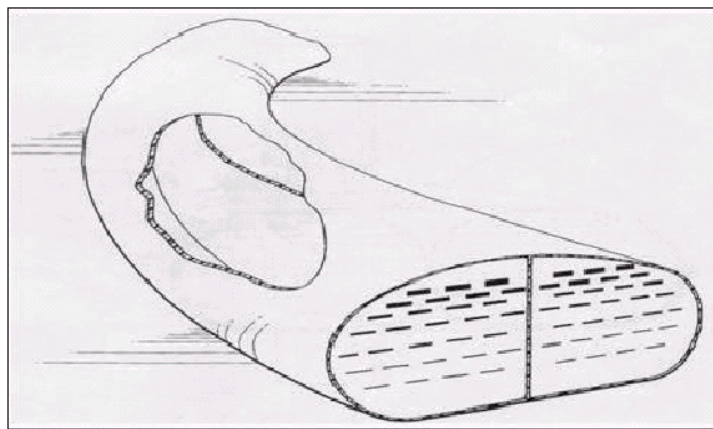

PORTABLE, WATER-FILLED DAM

- Water diversion for dewatering
- Cofferdam
- Silt containment

Source:
AquaDams/Water Structures Unlimited
[www.waterstructures.com/
Applications/page1.html](http://www.waterstructures.com/Applications/page1.html)

AQUA BARRIER

BMP- COFFERDAM

DESCRIPTION

A cofferdam is a temporary structure built into a waterway to enclose a construction area and reduce sediment pollution from construction work in or adjacent to water. Cofferdams may be made of rock, sand bags, wood or aqua barriers.

APPLICATIONS

This BMP may be used in construction activities such as streambank stabilization, culvert installation, bridges, piers or abutments. It may be used in combination with other methods such as clean water bypasses and/or pumps.

LIMITATIONS

A cofferdam is a potentially serious “taking” issue (could cause harm to listed species) and is not a routine road maintenance BMP. For information on incidental take permits for fish habitats, see Chapter 2-Permits. Consultation with a fisheries biologist and agency biologists is imperative if there are salmonids present in the stream system. A Streambed Alteration Agreement (1600permit) is needed from DFG which will outline the terms and conditions to protect aquatic habitat and species.

Do *not* use this BMP:

- ✓ if there is insufficient stream flow to support aquatic species.
- ✓ in deep water unless designed or reviewed by an engineer.
- ✓ to completely dam stream flows.

CONSTRUCTION GUIDELINES

- 1) When used in watercourses or streams, cofferdams must be used in accordance with permit requirements. Materials for cofferdams should be selected based on ease of maintenance and complete removal following construction activities.
- 2) Construct cofferdams of sandbags, placed by hand. Sandbags should be filled with clean river run gravels.
- 3) Cover dam covered in visqueen to minimize water infiltration

BMP MAINTENANCE

- ✓ During construction, inspect daily during the work week.
- ✓ Schedule additional inspections during storm events.
- ✓ Immediately repair any gaps, holes or scour.

BMP REMOVAL

- ✓ Remove sediment buildup.
- ✓ Remove BMP. Recycle or re-use if applicable.
- ✓ Revegetate areas disturbed by BMP removal if applicable.

BENEFITS/LIMITATIONS

- Difficult to dewater*
- Inexpensive*
- Labor intensive to install and remove*
- Sand may be deposited in stream if bags break, better to use clean gravel*

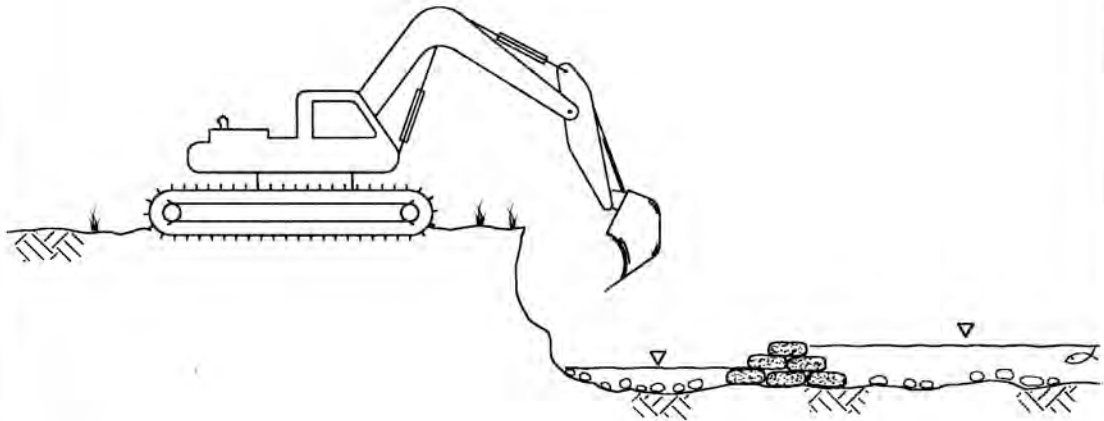

SAND BAG/GRAVEL BAG TECHNIQUE

**INSTREAM EROSION AND SEDIMENT
CONTROL ISOLATION TECHNIQUES**

FILE: Instream Techniques3

BENEFITS/LIMITATIONS

- Allows partial dewatering*
- Relatively inexpensive*
- Useful for small streams*
- Minimal TSS when removed*

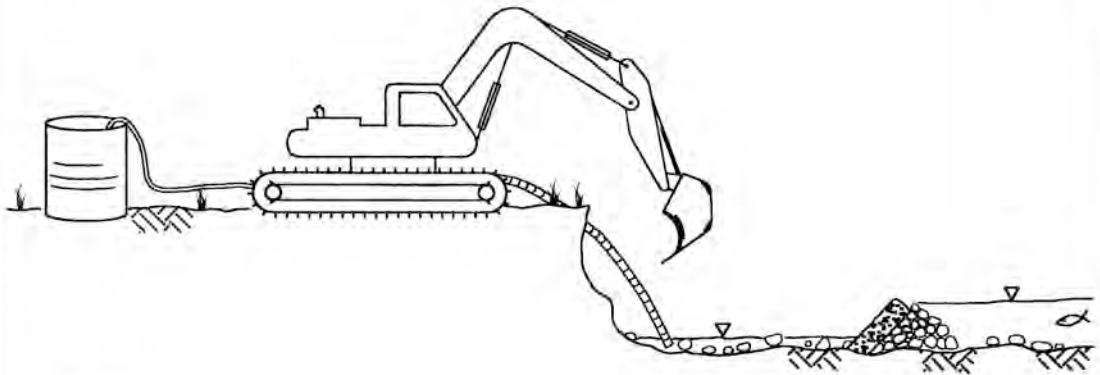

NOTES:

- Step 1. Install clean gravel*
- Step 2. Place impermeable soil*
- Step 3. Do work*
- Step 4. Decommission berm by removing soil layer first*
- Step 5. Pump work area. Head differential will cause turbo water to flow into work area*
- Step 6. Remove or spread gravel*

**GRAVEL/SOIL BERM INSTREAM
ISOLATION TECHNIQUE**

FILE: Berm Instream Techniques

BENEFITS/LIMITATIONS

- Allows full dewatering
- Relatively expensive
- Useful in large rivers, lakes, high velocity
- Not really appropriate for small streams
- Requires staging and heavy equipment access areas

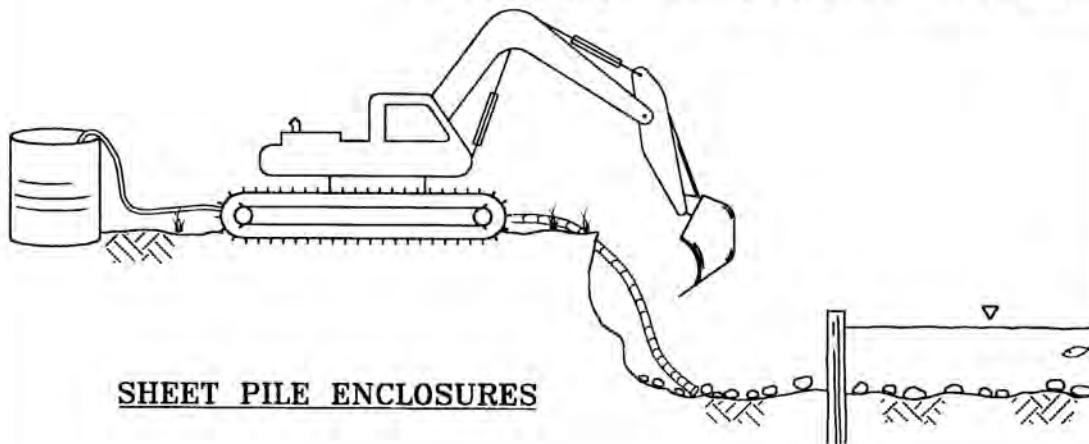

SHEET PILE ENCLOSURES

BENEFITS/LIMITATIONS

- Allows partial dewatering
- Moderately expensive
- Ease of installation and removal unknown
- Can be designed for small streams to large rivers

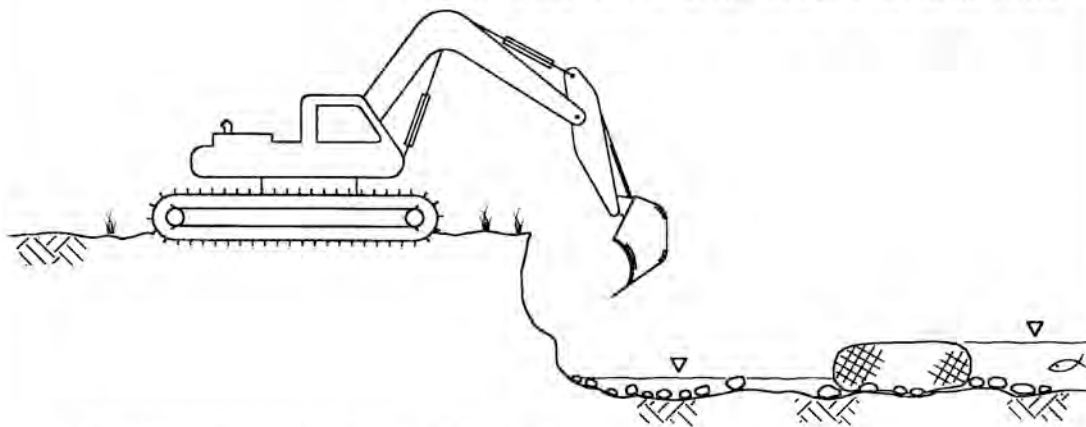

WATER-FILLED GEOTEXTILE (AQUA DAM)

**INSTREAM EROSION AND SEDIMENT
CONTROL ISOLATION TECHNIQUES**

FILE: Instream Techniques2

BENEFITS/LIMITATIONS

- Allows partial dewatering*
- Many different types available*
- Relatively expensive*
- Can be designed for large and small streams*
- Ease of installation and removal unknown*

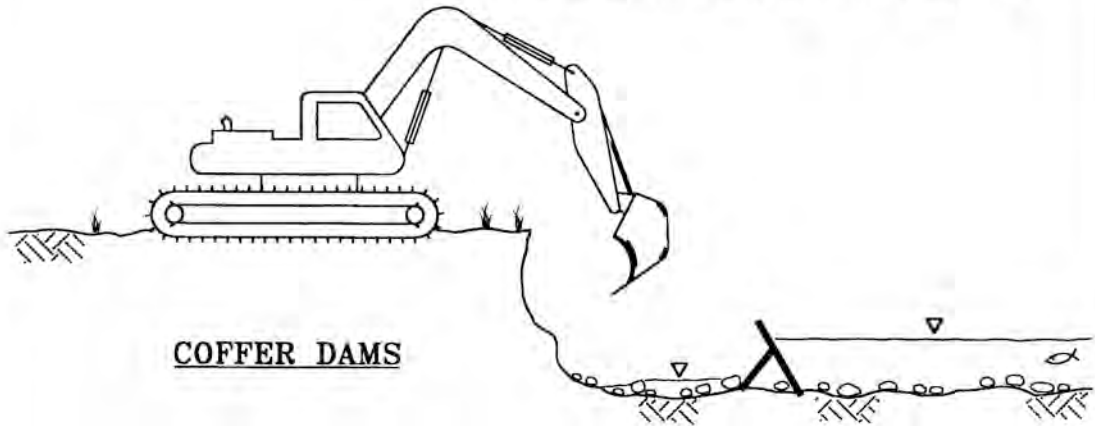

COFFER DAMS

BENEFITS/LIMITATIONS

- Does not allow dewatering*
- Inexpensive*
- Used in slow water lakes only*
- Not very effective especially when removing*

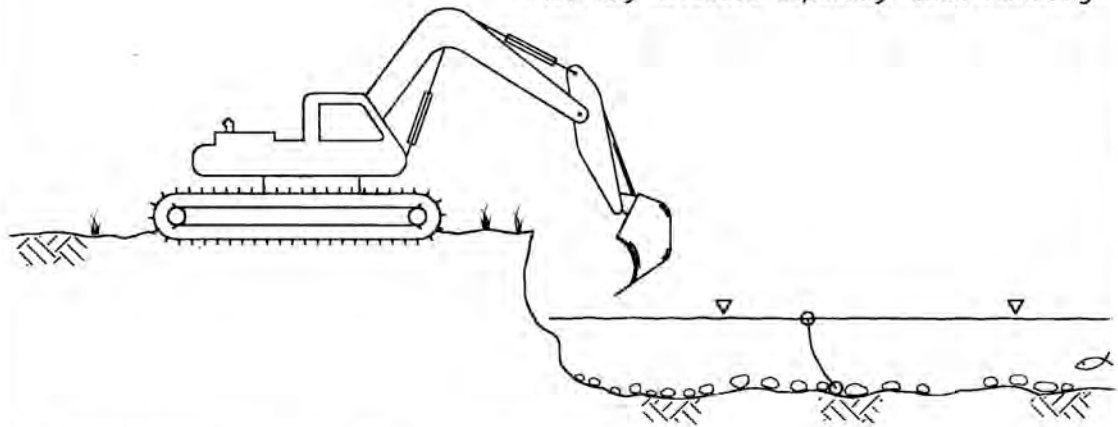

GEOTEXTILES, SILT BARRIERS, CURTAINS

**INSTREAM EROSION AND SEDIMENT
CONTROL ISOLATION TECHNIQUES**

FILE: Instream Techniques1

BMP – DEWATERING

DESCRIPTION

A temporary method to remove and filter water from excavated areas on construction sites prior to discharge to the storm drain or surface waters. See also Aqua Barrier, Cofferd Dam, and Stream Bypass BMPs.

APPLICATIONS

Used for draining creeks, lakes, ponds, sediment traps, basins, or excavations on construction sites. Also used wherever sediment-laden water must be removed from the construction site using a dewatering pump.

LIMITATIONS

- ✓ Conditions at individual sites will determine the scope and applicability of dewatering.
- ✓ Dewatering is subject to federal, state, and local permits.
- ✓ The discharge of sediment-laden water from a dewatering site into any water of the State without filtration is prohibited.
- ✓ A fish or aquatic wildlife rescue plan may be required.

CONSTRUCTION GUIDELINES-

See Chapter 6.5- Dewatering for detailed Best Management Practices to minimize impact on fish and other aquatic organisms when dewatering a project site.

- 1) A dewatering structure should be sized to allow water to flow through any filtering media without overflowing the structure.
- 2) Adequate erosion and sediment control measures are to be considered first. Dewatering practices should be considered as a last-resort control measure.
- 3) Check water for odors, discoloration, or an oily sheen. If present, have the water tested by a certified lab. Discuss test results with Regional Water Quality Control Board Staff to determine how and where to discharge.
- 4) An energy dissipater may be needed to prevent erosion at the outlet.

BMP MAINTENANCE

- ✓ Inspect and clean sediment control devices frequently to prevent build-up or blockage of the sediment filters.
- ✓ Monitor effluent to ensure that no sediment is discharged into a storm drain or water of the State.

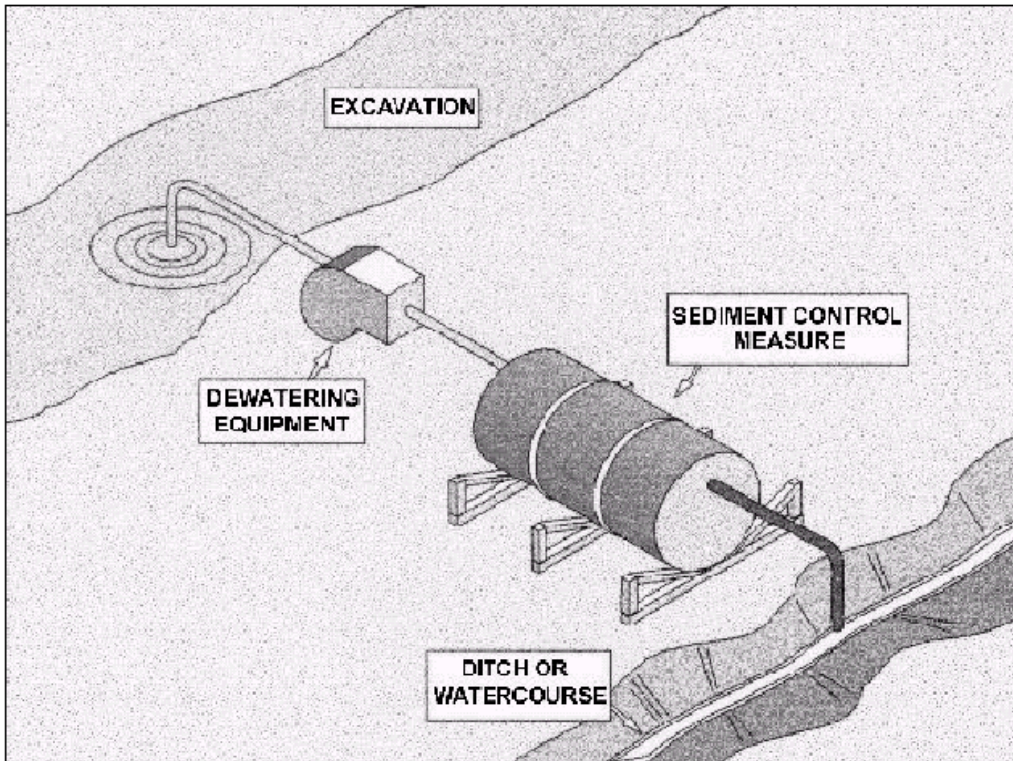

SEE ALSO;
AQUA BARRIER
STREAM BYPASS (WATER DIVERSION)
COFFER DAM.

Source:
Caltrans. Storm Water Quality Handbooks:
Construction Site Best Management Practices
Manual, November 2000.

**DEWATERING
& FILTERING**
(PUMPING OR DRAINING)

BMP - DIVERSION BERM

DESCRIPTION

A diversion berm is a temporary ridge of compacted soil or aggregate base material, sandbags or continuous bag berm constructed at the top or base of a disturbed slope. The purpose of the BMP is to direct stormwater runoff away from an unstable slope.

APPLICATIONS

This BMP may be used to temporarily divert stormwater runoff away from a disturbed slope and toward a sediment containment facility or stable runoff.

LIMITATIONS

A diversion berm is a potentially serious “taking” issue for endangered salmon and is not a routine road maintenance BMP. For information on incidental take permits for fish habitats, see *Chapter 2-Permits*.

Do *not* use this BMP:

- ✓ in fast flowing water.
- ✓ as a replacement for failing roadway shoulders.
- ✓ as slide debris storage within 150 feet of any water body.

CONSTRUCTION GUIDELINES

- 1) Adequately compact berm material to prevent failure.
- 2) Apply temporary seeding and mulch to all surfaces of a soil diversion berm according to the BMP-Seasonal Planning.

BMP MAINTENANCE

- ✓ Conduct periodic inspections, and repair berms as necessary.

BMP REMOVAL

- ✓ Evaluate site to determine BMP is no longer needed :verify that the area has stabilized and is no longer a potential source of sediment-laden water. .
- ✓ Remove sediment buildup.
- ✓ Remove BMP – recycle and/or re-use if applicable.
- ✓ Re-vegetate area disturbed by BMP removal.

BMP – FISH EXCLUSION

DESCRIPTION

Road maintenance activities may require work within streams that contain fish and other aquatic resources. Some of these activities require water to be diverted around the work site (see BMP – Stream Bypass) with the fish removed, relocated upstream of the work area, and excluded from the work site until work is completed.

APPLICATIONS

Fish exclusion may be necessary when work is done in watercourses and streams (slope stabilization, sediment removal, vegetation or habitat management, debris removal) and for repair, replacement, maintenance, or installation of stream crossings (pipes, culverts, fish ladders) and bridges.

LIMITATIONS

- ✓ Fish exclusion from the work site prior to dewatering must be with authorization from the National Marine Fisheries Service and the California Department of Fish and Game. Fish exclusion is done only under the supervision of a qualified fisheries biologist with the appropriate State and Federal permits.

CONSTRUCTION GUIDELINES

- 1) Isolate the work area (block nets).
- 2) Remove as many fish as possible using seines and relocate upstream or downstream in pools of adequate size.
- 3) Gradually dewater work area.
- 4) Remove as many remaining fish as possible using seines and dip nets, and relocate.
- 5) Electroshock, if required by permit, to avoid any strandings in pools where other methods are ineffective.

BMP MAINTENANCE

- ✓ Keep records of fish exclusion activities.
- ✓ Obtain any needed training from the qualified fishery biologist.
- ✓ Only assist the supervising fisheries biologist in accordance with State and Federal procedures when requested.

- ✓ Help clean fish screens of leaves and debris as necessary, and report any mortality to the supervising biologist.

BMP REMOVAL

- ✓ Once work is completed, gradually return the stream to its original condition so as not to cause a surge downstream or strand fish upstream.

SOURCES

Five Counties Salmonid Conservation Program. 2002. A Water Quality and Stream Habitat Protection Manual for County Road Maintenance in Northwestern California Watersheds. [<http://www.5counties.org/>]

BMP - LEVEL SPREADERS

DESCRIPTION

A non-erosive outlet for concentrated runoff constructed to disperse flow uniformly across a slope.

APPLICATIONS

Use to convert concentrated flow to sheet flow and release it uniformly over a stabilized area. The level spreader is most often used as an outlet for temporary or permanent diversions and diversion dikes. Runoff water containing high sediment loads must be treated in a sediment-trapping device before release in a level spreader.

LIMITATIONS

Use this BMP if:

- ✓ sediment-free storm runoff can be released in sheet flow down a stabilized slope without causing erosion.
- ✓ a level lip can be constructed without filling.
- ✓ the area below the spreader lip is uniform with the slope of 10% or less and is stable for anticipated flow conditions, preferably well vegetated.
- ✓ the runoff water will not re-concentrate after release.
- ✓ there will be no traffic over the spreader.

CONSTRUCTION GUIDELINES

- 1) The level spreader is a relatively low-cost structure to release small volumes of concentrated flow where site conditions are suitable. The outlet area must be uniform and well vegetated with slopes of 10% or less. Take particular care to construct the outlet lip completely level in a stable, undisturbed soil. Any depressions in the lip will concentrate the flow, resulting in erosion.
- 2) Determine the capacity of the spreader by estimating peak flow from the 10-year storm. Restrict the drainage area so that maximum flows into the spreader will not exceed 30 cfs.
- 3) When water enters the spreader from one end, as from a diversion, select the appropriate length, width, and depth of the spreader from the table below:

Design Flow (cfs)	Entrance Width (ft)	Depth (ft)	End Width (ft)	Length (ft)
0-10	10	0.5	3	10
10-20	16	0.6	3	20
20-30	24	0.7	3	30

- 26) Construct the level lip on undisturbed soil to uniform height and zero grade over the length of the spreader. (However, aprons frequently cannot be set at zero grade due to slope.) Protect it with an erosion-resistant material, such as erosion control blankets or mats, to prevent erosion and allow vegetation to become established.
- 27) The blankets or matting should be a minimum of 4 ft wide extending 6 inches over the lip and buried 6 inches deep in a vertical trench on the lower edge. The upper edge should butt against smoothly cut sod and be securely held in place with closely spaced heavy-duty wire staples at least 12 inches long.
- 28) Ensure that the spreader lip is level for uniform spreading of storm runoff.
- 29) Construct the level spreader on undisturbed soil (not on fill).
- 30) Construct a 20-ft transition section from the diversion channel to blend smoothly to the width and depth of the spreader.
- 31) Disperse runoff from the spreader across a properly stabilized slope not to exceed 10%. Make sure the slope is sufficiently smooth to keep flow from concentrating.
- 32) Immediately after its construction, appropriately seed the disturbed area with native grasses and mulch.

BMP MAINTENANCE

- ✓ Inspect level spreaders after every rainfall until vegetation is established, and promptly make needed repairs. After the area has been stabilized, make periodic inspections and keep vegetation in a healthy, vigorous condition.

BMP REMOVAL

- ✓ Removal is not necessary.

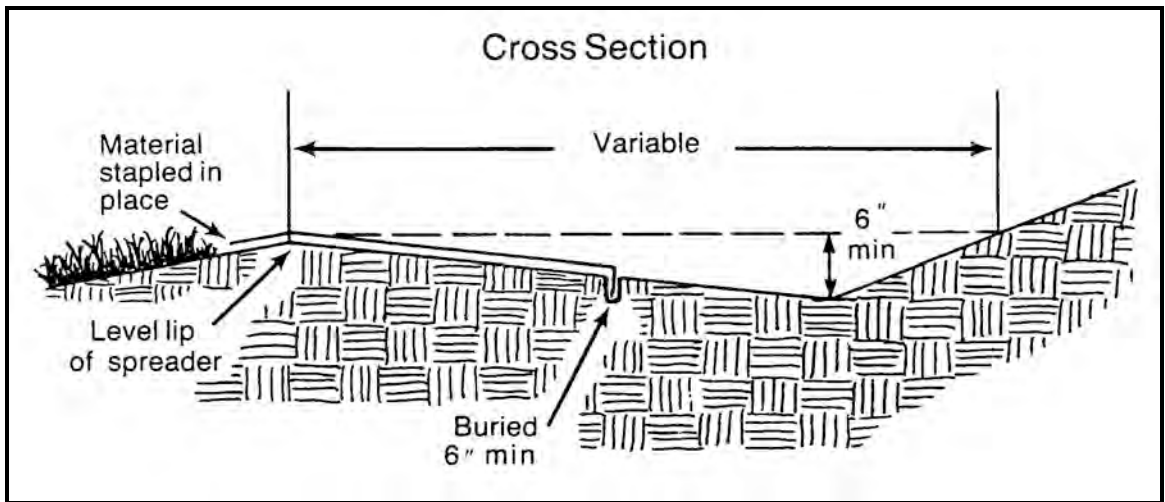
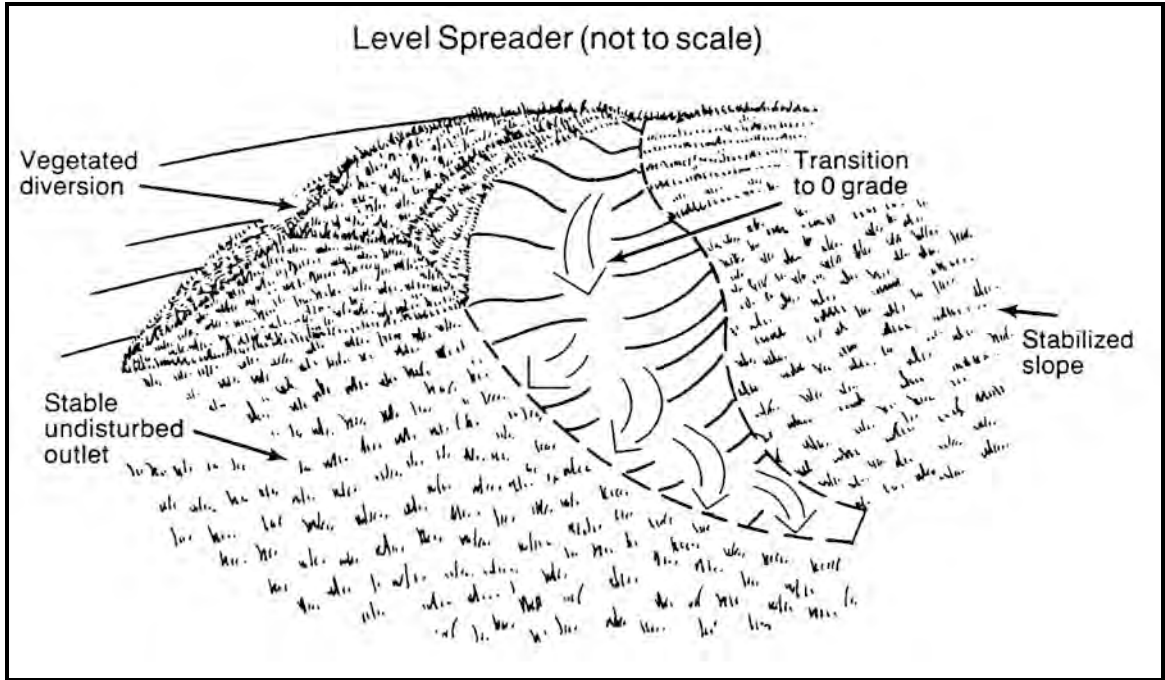

BMP – SANDBAG

DESCRIPTION

A sandbag is a pre-manufactured cloth or plastic bag filled with sand or gravel. Sandbags can be used to keep water away from work areas and unstable slopes, and to construct curb inlet sediment barriers. Sandbags are also used as protection against flooding, as ballast, and in the construction of cofferdams and clean water bypasses.

APPLICATIONS

This BMP may be used during emergencies to control the flow and level of water. It may be used during construction to form dewatered areas such as cofferdams and clean water bypasses.

LIMITATIONS

Do *not* use this BMP where prohibited by permit conditions or as a permanent structure.

CONSTRUCTION GUIDELINES

- 1) When using this BMP in water bodies, fulfill appropriate permit conditions.
- 2) Secure ends of sandbags to ensure material does not scatter.
- 3) When used as a barrier, stack bags tightly together and in alternative (bricklayer) fashion.
- 4) Fill bags with clean sand or gravel.

BMP MAINTENANCE

- ✓ During construction, inspect daily with additional inspections during storm s.
- ✓ Replace damaged sandbags.
- ✓ Remove sediment when deposits reach the height of the sandbag barrier.

BMP REMOVAL

- ✓ Evaluate site to determine when BMP is no longer needed.
- ✓ Remove sediment buildup in front of BMP.
- ✓ Remove BMP, recycle and/or re-use if applicable.
- ✓ Revegetate area disturbed by BMP removal and spread material in sandbags on slopes and stable areas where allowed by permit conditions.

BMP – SLOPE DRAIN – TEMPORARY

DESCRIPTION

A slope drain is a pipe used to temporarily intercept and divert runoff into stabilized areas. May be used with lined ditches to intercept and direct surface flow away from slope areas.

APPLICATIONS

Slope drains may be used at construction sites where slopes may be eroded by surface runoff.

LIMITATIONS

- ✓ Severe gully erosion may occur if the drain fails.

CONSTRUCTION GUIDELINES

- 1) The slope drain should be heavy duty flexible PVC, ABS or comparable pipe.
- 2) A dike should be used to direct runoff to the drain. The inlet should be lined with filter cloth.
- 3) The drainage area should be no larger than 10 acres per pipe.
- 4) Slope should be no greater than 2:1 (H:V).
- 5) Riprap or other energy dissipation device should be used at the outlet.
- 6) Drains should be perpendicular to the contour of the slope.
- 7) Compact soil around and under entrance, outlet, and along the length of the pipe.
- 8) The drain should be anchored and stabilized into the soil with water tight connections.
- 9) For drains 12 inches and larger a standard flared end section should be used.

BMP MAINTENANCE

- ✓ Check connections, inlet and outfall areas frequently for signs of distress to prevent slope drain failure.

- ✓ Inspect drains before and after rainfall or heavy use for signs of erosion or scour. Additional energy dissipaters or reduced flow may be necessary to accommodate flow.
- ✓ Remove sediment accumulation. If necessary, flush out debris from pipe and trap sediment before it enters a waterway.

BMP REMOVAL

- ✓ When site is stabilized, remove structure, grade out slope, seed and mulch bare areas.

SOURCE

Caltrans. Storm Water Quality Handbooks: Construction Site Best Management Practices Manual, page SS-11.3, November 2000.

SLOPE DRAIN - TEMPORARY

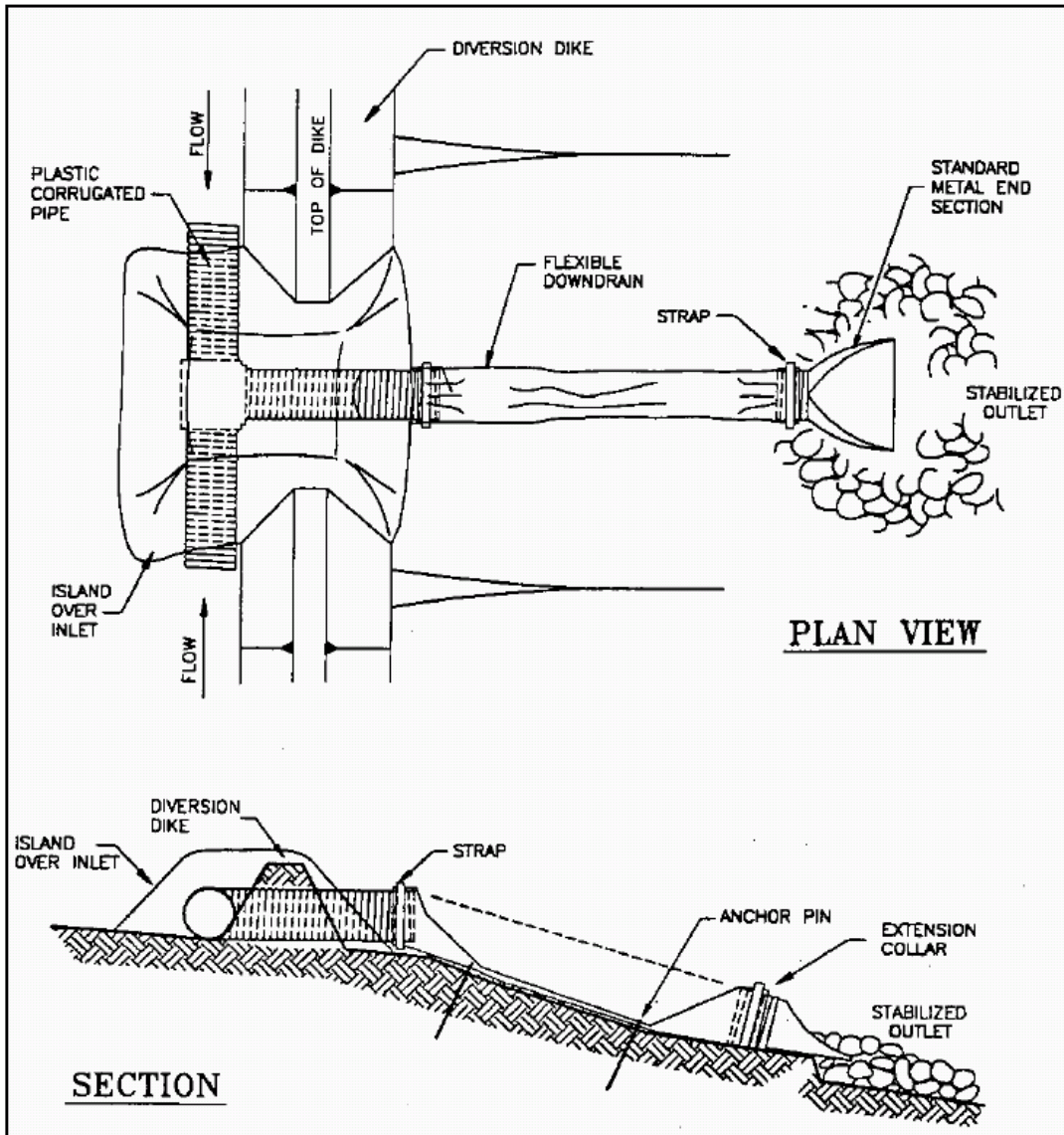

Source: McCullah, J. 1992. Erosion and Sediment Control Standards Design Manual
- County of Shasta. Prepared for the Western Shasta RCD. Redding CA. 187 p.

BMP – SLOPE DRAIN –OVERSIDE

DESCRIPTION

A slope drain is a pipe or open chute used to intercept and divert runoff into stabilized areas.

APPLICATIONS

Slope drains may be used to drain certain bench or road way configurations where it is necessary to minimize flow onto cut or fill slopes.

LIMITATIONS

- ✓ Severe gully erosion may occur if the drain fails.

CONSTRUCTION GUIDELINES

- 1) The slope drain should be heavy duty flexible PVC, ABS, corrugated metal, or comparable pipe. It may be open trough shape (half culvert, lengthwise).
- 2) A dike should be used to direct runoff to the drain. The inlet should be lined with filter cloth.
- 3) The drainage area should be no larger than 10 acres per pipe.
- 4) Slope should be no greater than 2:1 (H:V).
- 5) Riprap or other energy dissipation device should be used at the outlet.
- 6) Drains should be perpendicular to the contour of the slope.
- 7) Compact soil around and under entrance, outlet, and along the length of the pipe.
- 8) The drain should be anchored and stabilized into the soil with water tight connections.
- 9) For drains 12 inches and larger a standard flared end section should be used.
- 10) Drains must be anchored to the slope with water tight connections.

See also: CalTrans Standard Plans, "Overside Drains," Plan #D87D.
www.dot.ca.gov/hq/esc/oe/project_plans/index.htm

BMP MAINTENANCE

- ✓ Check connections, inlet and outfall areas frequently for signs of distress to prevent slope drain failure.
- ✓ Inspect drains before and after rainfall or heavy use for signs of erosion or scour. Additional energy dissipaters or reduced flow may be necessary to accommodate flow.
- ✓ Remove sediment accumulation. If necessary, flush out debris from pipe and trap sediment before it enters a waterway.

BMP REMOVAL

- ✓ N/A

SLOPE DRAIN - OVERSIDE

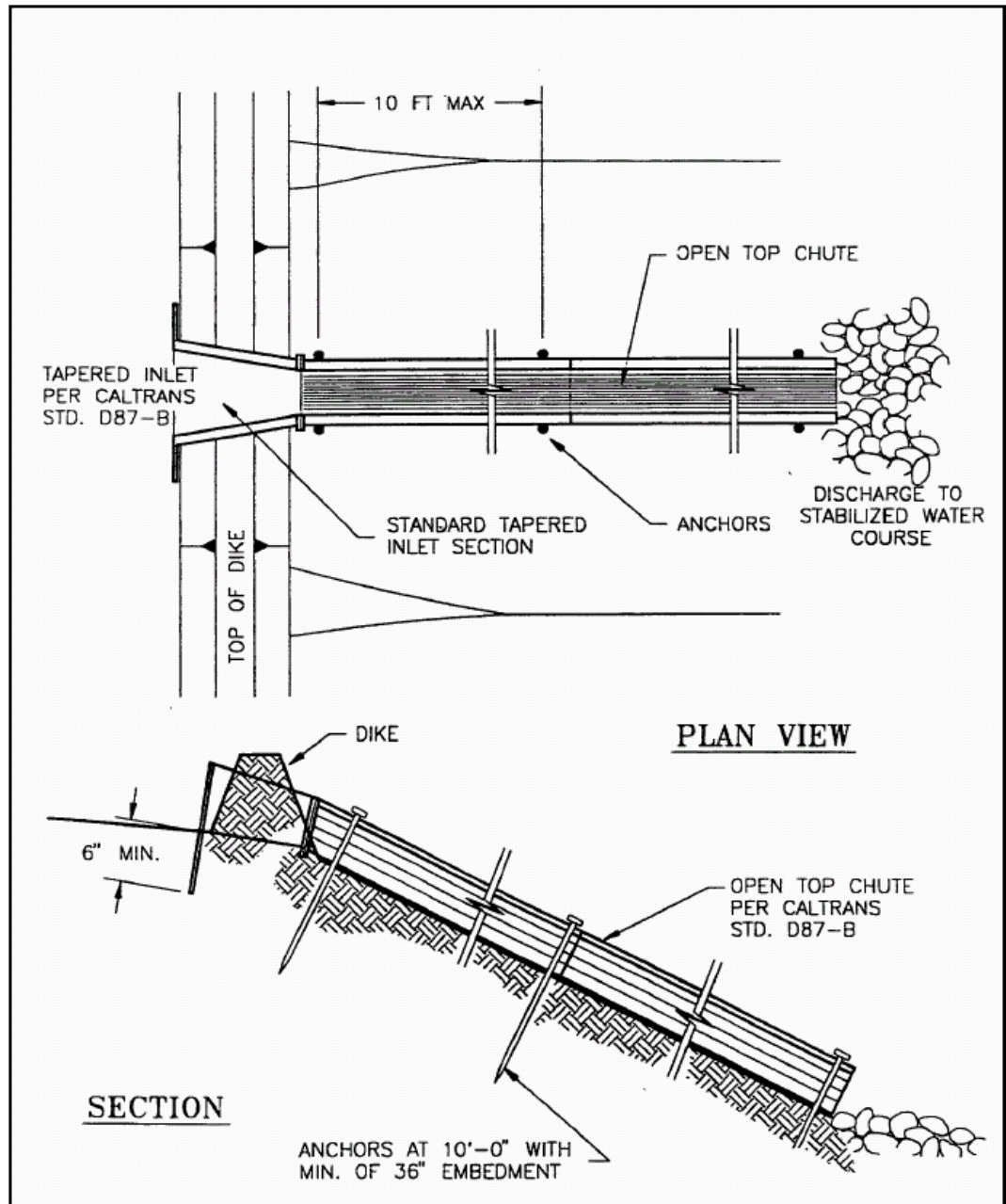

Source: McCullah, J. 1992. Erosion and Sediment Control Standards Design Manual - County of Shasta. Prepared for the Western Shasta RCD. Redding CA. 187 p.

✓

BMP – SLOPE DRAIN –SWALE

DESCRIPTION

A constructed water channel excavated into a side hill or built with an earthen dike. Typically built nearly parallel to the hillslope contour with a 2% or greater flowline grade.

APPLICATIONS

Swales or ditches are used to divert and convey surface run-on away from the work site or unstable area, into a stable area in order to prevent erosion. Also used below steep grades where runoff begins to concentrate, at the top of slopes, and as slope breaks.

LIMITATIONS

- ✓ Not suitable as sediment trapping devices
- ✓ May be necessary to use other soil stabilization and sediment controls such as check dams, erosion control blankets, turf reinforcement mat, or rock to prevent scour and erosion in newly graded swales.

CONSTRUCTION GUIDELINES

- 1) Slope drain swales must be correctly sized to accommodate the flows of the contributing watershed.
- 2) Conveyances must be stabilized by compaction, vegetation, matting and/or hard armor depending on the calculated flow velocity.
- 3) Water should be outlet back to the natural watercourse as soon as possible and not diverted into another watershed if possible.
- 4) Provide stabilized outlets.

BMP MAINTENANCE

- ✓ Inspect newly constructed swales prior to the rainy season, after rainfall events, and regularly during the rainy season.
- ✓ Replace lost riprap, lining, or soil stabilizers as needed.
- ✓ Inspect channel linings, embankments, and beds of ditches and berms for erosion and accumulation of debris and sediment. Remove debris and sediment, and repair linings and embankments as needed.

BMP REMOVAL

- ✓ If temporary, remove as soon as the surrounding drainage area has been stabilized, recontour the slope, seed and mulch bare areas.

✓ SLOPE DRAIN SWALE PDF

BMP - STREAM BYPASS (WATER DIVERSION)

DESCRIPTION

A stream diversion is a temporary bypass through a pipe, flume, or excavated channel that carries water flow around work areas.

APPLICATIONS

Commonly used for culvert installation or replacement. Where possible, a stream diversion should be the first choice to control erosion and sediment during the construction of culverts or other instream structures.

Maintaining a live channel is always the utmost priority. Therefore, we recommend a partial bypass. [BL: New NOAA comment. Also, NOAA says “Pumps should not be used” and “Stream diversions should not be used”. I’m obviously missing something - They’re not asking to remove this entire BMP, are they?]

LIMITATIONS

The stream diversion technique you use depends upon the type of work involved, physical characteristics of the site, and the volume of water flowing through the project.

Advantages of a pumped diversion include:

- ✓ Downstream sediment transport can almost be eliminated.
- ✓ De-watering of the work area is possible.
- ✓ Pipes can be moved about to allow construction operations.
- ✓ The dams can serve as temporary access.
- ✓ Increased flows can be managed by adding more pumping capacity.

Some disadvantages of a pumped diversion are:

- ✓ Flow volume is limited by pump capacity.
- ✓ Requires 24-hour monitoring of pumps.
- ✓ Sudden rain could overtop dams
- ✓ Creates in-stream disturbance to install and remove dams.

Advantages of excavated channels and flumes are:

- ✓ Isolates work from water flow and allows dewatering
- ✓ Can handle larger flows than pumps.

Disadvantages of excavated channels and flumes are:

- ✓ Bypass channel or flume must be sized to handle flows, including possible floods.
- ✓ Channels must be protected from erosion.
- ✓ Flow diversion and then re-direction with small dams causes in-stream disturbance and sediment.

Do not use stream diversions;

- ✓ without identifying potential impacts to the stream channel.
- ✓ until all necessary permits have been obtained. A stream bypass is a potentially serious “taking” issue and is not a routine road maintenance BMP (for information on incidental take permits for fish habitats, see Chapter 2-Permits).

CONSTRUCTION GUIDELINES

- 1) Guidelines vary based on existing site conditions.
- 2) The preferred option is a partial bypass, which maintains a live stream channel.
- 3) Size pipes adequately to allow fish passage.

BMP MAINTENANCE

- ✓ Closely monitor and maintain all stream diversions
- ✓ Pumped diversions require 24-hour monitoring of pumps

BMP REMOVAL

- ✓ Once the work is completed, remove the stream diversion and redirect the flow through the new culvert or back into the original stream channel.

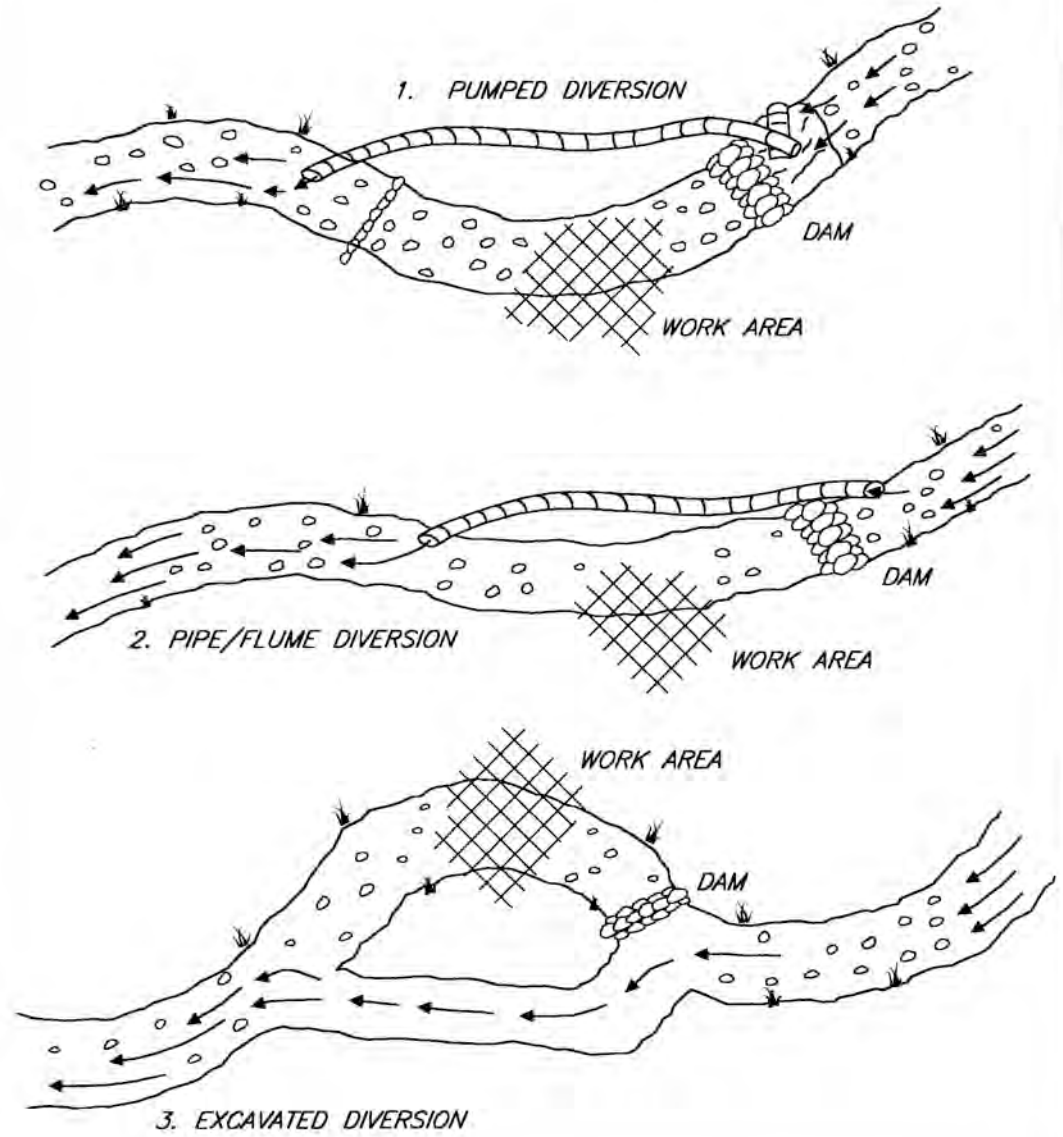

**TYPICAL STREAM
DIVERSION TECHNIQUES**

FILE: Stream Diversion

STREAMBANK PROTECTION BIOTECHNICAL BMPs

- **BRUSH MATTRESS**..... A-187
- **HARVESTING AND HANDLING OF WOODY CUTTINGS**A-193
- **LARGE WOODY DEBRIS REVETMENT**..... A-195
- **WILLOW WALL REVETMENT**.....A-199
- **LIVE POLE DRAIN**..... A-203
- **LIVE STAKES**..... A-205
- **FABRIC REINFORCED EARTH FILL WITH BRUSH LAYERING** A-209
- **WATTLES/FASCINES**..... A-213

BMP – BRUSH MATTRESS

DESCRIPTION

A brush mattress or brush mat is a revegetation technique that provides a protective covering to a slope or streambank as soon as it is installed. A brush mattress is typically constructed using live willow branches or other species that root easily from cuttings, but can also be constructed with any brushy, woody branches in order to provide immediate and effective slope protection.

Brush mattresses quickly stabilize a slope or streambank by providing a dense network of branches, which prevent superficial erosion, while also collecting soil and native seeds. The overlapping branches provide an ideal environment for native seeds to germinate and establish. As the live branches root and grow, the soil is reinforced with an underground matrix of spreading roots. If used on streambanks, a brush mat traps sediments during high water, and eventually the plant growth on the stabilized streambank provides aquatic habitat. Brush mattresses work well for stabilizing reconstructed stream channels, as they provide immediate cover for fish and instant bank protection, even before they become established and grow.

Of all the streambank biotechnical practices, brush mattresses can withstand the highest velocities. Studies conducted by Christoph Gerstgraser, (Universitat fur Bodenkultur, Vienna, Austria), demonstrated that brush mattresses stabilized the bank in a test flume against velocities exceeding 7 mps (20 f/s), while other techniques, even rock riprap, failed.

APPLICATIONS

Brush mattresses are ideal for eroding streambank slopes where immediate protection is needed. Installing a brush mattress along an eroding reach can rapidly stabilize streambanks in danger of being scoured due to high erosive forces.. The mattress's dense layer of brush helps deflect water from the bank and protect it from scouring, while also providing habitat directly along the water's edge. Brush mattresses also work well for shoreline protection. The mat's density breaks the impact of waves and instantly provides a thick protective layer of brush along the shoreline.

If the desire is to stabilize and revegetate an eroding streambank or shoreline and discourage foot trails along sensitive areas, brush mats work well as impenetrable barriers, giving time for vegetation to become established. On slopes, brush mattressing provides rapid protection against superficial erosion. Brush mats are often combined with other soil stabilization techniques such as vegetated riprap, wattles, live facines, root wads, live siltation, or coir logs, which may be needed to secure the toe of the slope. The brush mattress technique is usually most effective on slopes no steeper than 2H:1V.

For gully repair on steeper slopes, see *Sediment Control- Brush Packing*.

LIMITATIONS

- ✓ A brush mattress requires large numbers of cuttings, probably more than any other biotechnical method. Carefully evaluate availability of plant material before including this technique in a revegetation design.
- ✓ Brush mat installation is a labor-intensive construction method.
- ✓ In areas with little rainfall, brush mattresses installed on dry slopes may not survive long, as this technique does not entrench the branches deeply into the soil.
- ✓ If constructing a brush mattress on a streambank, do not leave loose overhanging branches. They may catch on material floating down the stream channel and the mattress may be ripped from the streambank.
- ✓

CONSTRUCTION GUIDELINES

- 1) Use wooden construction stakes and/or live stakes (such as willow). The length of stakes will vary based on soil conditions. Biodegradable natural fiber rope is usually preferable to wire.
- 2) Prepare the slope or streambank by clearing away large debris, and grading the slope so that branches will lie flat on the bank. Do not disturb the slope or bank any more than necessary.
- 3) Excavate a horizontal trench, 8 to 12 inches deep, at the toe of the streambank or at the base of applicable area on the slope. The basal ends of the branches should extend into moist soil.
- 4) Lay the cuttings flat against the graded slope, slightly crisscrossed, with the basal ends placed as deeply into the trench as possible. Continue to lay the cuttings along the face of the bank or slope until about 80% groundcover is achieved (about 6-12 inches thick).
- 5) If the cuttings are shorter than the slope or bank,, stagger and overlap the cuttings so the entire area has adequate coverage.
- 6) You may plant rooted plants within the brush mattress, before the branches are laid. It is too difficult to plant through the mattress afterward.
- 7) Pound in a grid of 24 to 36 inch long stakes into the mattress at 3 to 4 foot centers (see typical drawing: Brush Mattress). Do not pound the stakes completely in, as this will be done after tying. Use longer stakes in less cohesive (sandy) soil.

- 8) Secure the brush mattress by using cord, rope, or 10-12 gauge-galvanized wire tied in a diamond pattern between each row of stakes. (Tie the cord or wire to the stakes in such a manner that if it breaks, the integrity of the remaining cord or wire is still maintained). Notching or drilling stakes may make securing cord or wire to stakes easier, but is not necessary.
- 9) After networking the mattress with cord or wire, drive the stakes in further to compress the mattress tightly against the slope.
- 10) Secure the toe of the mattress using the technique best suitable for the site conditions. To secure the toe of the mattress using a willow wattle, first construct a wattle the length of the area to be treated (see wattle technique). Make sure the wattle is tied together tightly. Place the wattle in the trench over the cut ends of the brush mattress. Secure the wattle with 18 to 48 inch long wedge-shaped wooden stakes every 3-4 feet. In some cases, such as small streams or gentle slopes, simply placing large locally collected rocks around and on top of the basal ends of the cuttings is enough to secure the toe of the mattress. Other techniques that may be used include vegetated riprap, wattles, live facines, rootwad revetments, live siltation, or coir logs.
- 11) Backfill around and in between the branches of the mattress by using material excavated from the trench, working the soil in well. Buckets of water will help to wash the soil down into the stems. It is most important for the thicker, basal ends of the mattress to get good soil cover for rooting, but generally cover at least 1/4 of the depth of the mattress with soil. If installed along a stream, make sure the upstream end of the mattress and wattle is keyed into the streambank to prevent high flows from scouring behind the mattress. It is also a good idea to protect this area with some revetment, large rocks, or tree trunks. If possible, tie the mattress to existing vegetation or roots on the bank for extra security.
- 12) Cover entire mattress with a thin layer (1 to 1.5 inches) of fine dirt.

BMP MAINTENANCE

- ✓ Make sure you periodically monitor the brush mattress after it has been installed. This will provide valuable insight into the stabilization process and for future biotechnical projects. If the willow does not grow, the mattress will still provide stability, especially if it is backfilled and seeded with native grasses, sedges, or rushes.
- ✓ Periodic maintenance includes making sure the stakes and cord/wire are still securing the mattress to the streambank. Carefully check the upstream end to make sure flows are not getting behind the mattress.
- ✓ Irrigate through first two growing seasons.

BMP REMOVAL

- ✓ BMP removal is not necessary.

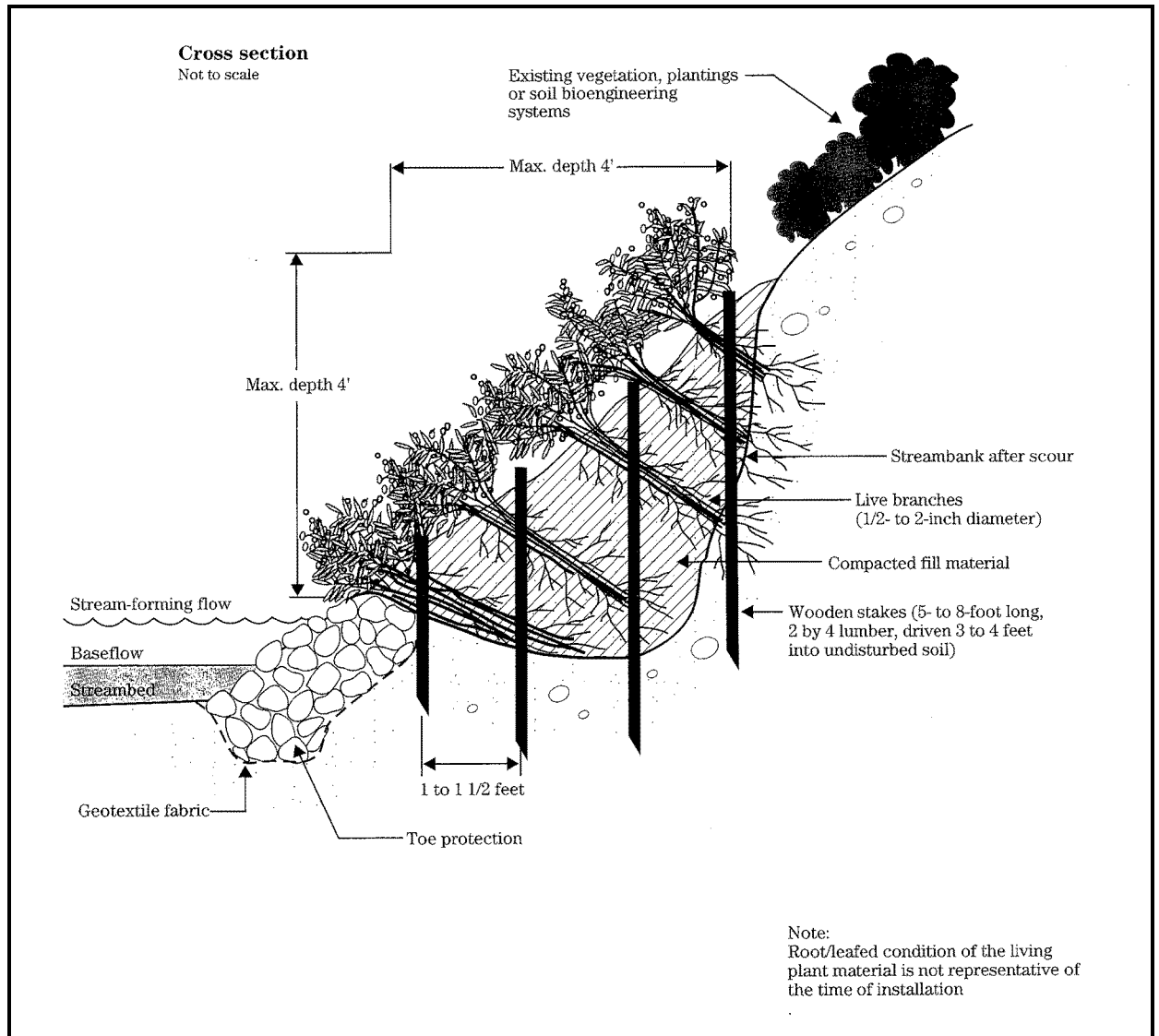

Note: CDFG encourages planting to below bankfull elevation and the addition of large woody debris (see B-7.4). Source: USDA Natural Resources Conservation Service. 1996. Engineering Field Handbook – Streambank and Shoreline Protection. Part 650, Chapter 16.

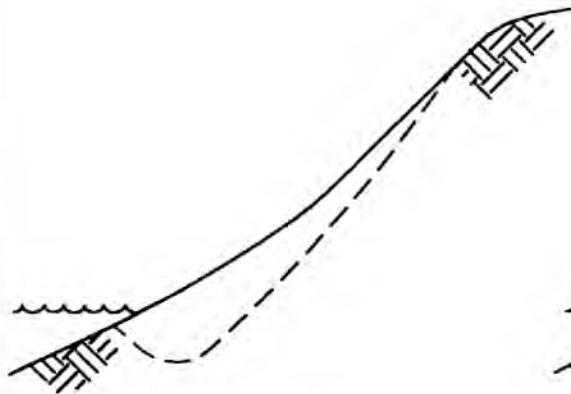

Step 1: Excavate trench and grade bank.

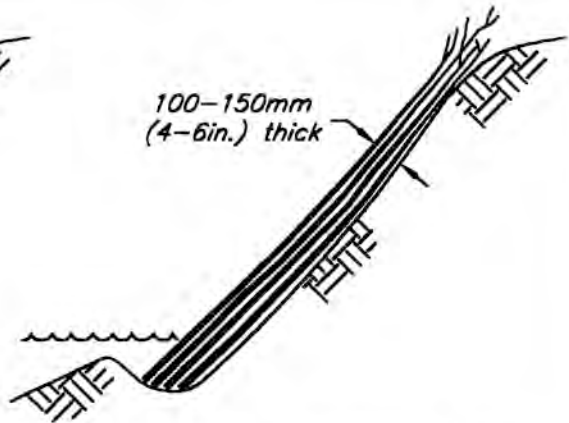

Step 2: Place willow branches making sure that the butt ends reach the bottom.

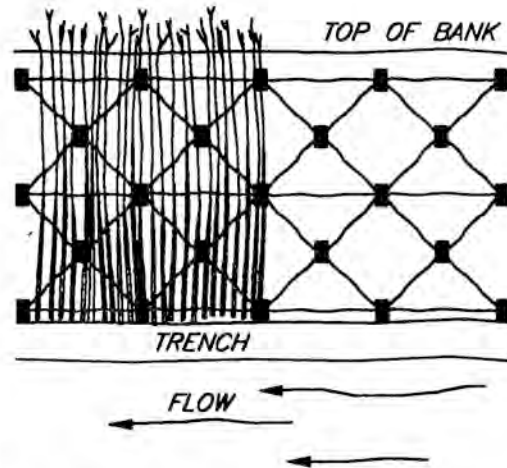

Step 3: Place stake (notched) on 1.0m (3ft.) centers and secure the mattress with twine, rope or wire.

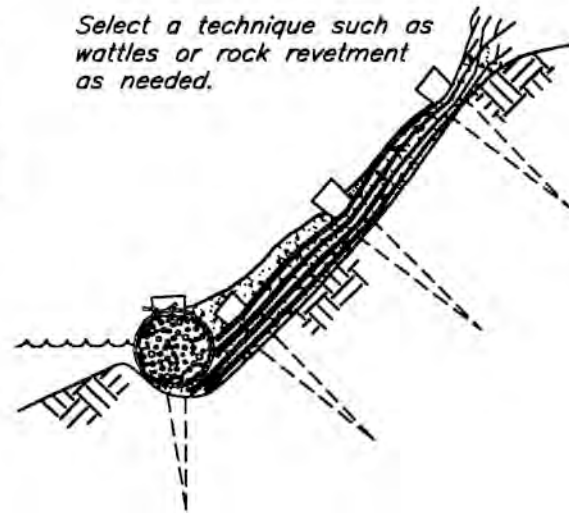

Step 4: Drive the stakes deeply into the bank to tightly compress the branches against the soil. Cover and partially bury the mattress to encourage rooting.

BRUSH MATTRESS

BMP - HARVESTING AND HANDLING OF WOODY CUTTINGS

DESCRIPTION

Proper harvesting and handling of live woody cuttings is essential to plant growth establishment. Cuttings must be harvested at optimum times of the year and safely transported without drying out. Willow and cottonwood species are typically used. See also BMP – Planting; BMP – Fabric Reinforced Earth Fill with Brush Layering (Vegetated Geodrid).

APPLICATIONS

Live woody cuttings are used in riparian plantings for habitat enhancement and streambank stabilization projects using soil bioengineering.

LIMITATIONS

- ✓ There may be limited quantities of harvestable cutting within a reasonable distance from the project site. Native cutting should ideally be from the watershed in which the project is implemented.
- ✓ There is a limited period during which cuttings can be collected and planted. The ideal time in Northern coastal California is October through January, although cuttings may be taken as early as August if the planting site is properly irrigated.
- ✓ Planting woody cuttings in the spring is not recommended as the plant's energy goes primarily to leaf production with an accompanying high evapo-transpiration demand at that time, especially on south facing slopes with coarse textured soils.
- ✓ Site conditions must be conducive to growth of the selected species: soil texture, moisture, and site aspect must be considered.

CONSTRUCTION GUIDELINES

- 1) Choose the right species from either the *Salix* (willow) or *Populus* (cottonwood) genus, depending upon what is growing naturally in the area. Plant form or structure (tree or shrub) may be an important criteria depending on the project goals (e.g., willowfly catcher habitat = shrubby vs. flood conveyance = tall, over-arching, shading). The willow genus includes low-growing, multiple stem shrubby species (arroyo, sandbar willow) and taller single stem forms (red, black, and yellow).

- 2) Hardwood cuttings are generally divided into three categories: Sprigs (or stakes) that are 0.75 to 1.5 inches in diameter and 36 to 48 inches long; Poles that are 1.5 to 3 inches in diameter and 5 to 8 feet long; and Branch Cuttings or Weavers which are no thinner than 1/2 inch and 6 to 12 feet long depending on the application (wattles, layering, willow wall revetments).
- 3) A good source of willow is along road right-of-ways. Another possible source is along drainage or irrigation canals. Donor trees or areas of trees from which cuttings are taken shall be pre-approved by project manager or biologist. No more than 50% of an existing cottonwood or willow clump shall be removed, unless the clump is scheduled to be removed by grading. Try to remove cuttings from inside the crown of the existing plant and spread the harvesting activity throughout the stand to minimize visual impact. No cuttings shall be taken from within 40 feet of a willow or cottonwood with an active bird nest in it.
- 4) Cuttings shall be cut clean with sharp hand saws or loppers. Branches of sprigs and poles shall be pruned off with sharp shears close to the main stem but just outside the branch collar. Some side branches may be left on the branch cuttings intended for brush layering and fascines. Trim the terminal bud (the bud at the growing tip) so the plant energy will be rerouted to the lateral buds and adventitious tissue. Cuttings with swelling, scar tissue, boring insects, or disease shall be rejected. Cuttings shall be cut from live healthy materials. The bottom end of the pole shall be cut at a 45° angle (approximately) and the top shall be cut flat, straight across (90° to the length of the pole).
- 5) Transportation: During cutting and transportation, keep cutting moist and in the shade by using wet burlap or wet sawdust and tarps. Never let the cuttings dry out or be exposed to sunlight until planted.!
- 6) Storage: Ideally, cuttings should be planted within 48 hours of harvest. Between time of harvest and planting, the bottom ends of the cuttings must be submerged and the tops kept moist. They should be soaked in a pond or river backwater and kept in the shade.
- 7) Installation: In most cases, a 1.5 foot radius area around the planting spot should be bare mineral soil. A planting hole may be prepared using an auger, water-jet, or by pounding a foundation stake into the ground (depending on planting depth). When the stake is pounded, the top should be protected with a cap or wire wraps, and any splits should be cut off. Ideally, the cutting should be long enough to extend into the capillary fringe of the water table. A minimum of two-thirds of the cutting should be below the ground surface.

BMP - LARGE WOODY DEBRIS REVETMENT

DESCRIPTION

Large woody debris (LWD) is any large piece of woody material generally defined as 6 inches and larger in diameter and at least 10 feet long, including the trunk and root mass, including stumps or rootwads.

APPLICATIONS

When incorporating woody material into projects, it is necessary to identify the desired performance and habitat benefits. Each project must be specifically tailored to meet the objectives identified for the habitat and any structures to be protected. It can be used in combination with other BMPs.

LWD in coastal streams creates exceptional habitat for salmonids and should be properly sized at 1.5 times channel width.

LIMITATIONS

Do *not* use this BMP:

- ✓ without identifying potential impacts to upstream and downstream banks, structures and facilities.
- ✓ when specific design requirements and desired habitat benefits have not been identified.
- ✓ in or adjacent to water bodies until all necessary permits have been obtained.

CONSTRUCTION GUIDELINES

- 1) Guidelines will vary based on existing site conditions, size and shape of the wood, forces exerted by moving water, etc.
- 2) Construct in accordance with design and permit conditions.

BMP MAINTENANCE

- ✓ Monitor large woody debris installed to ensure it remains as built. Consult as necessary for adjustments and/or modifications to large woody debris installations.

Large Woody Debris Revetment

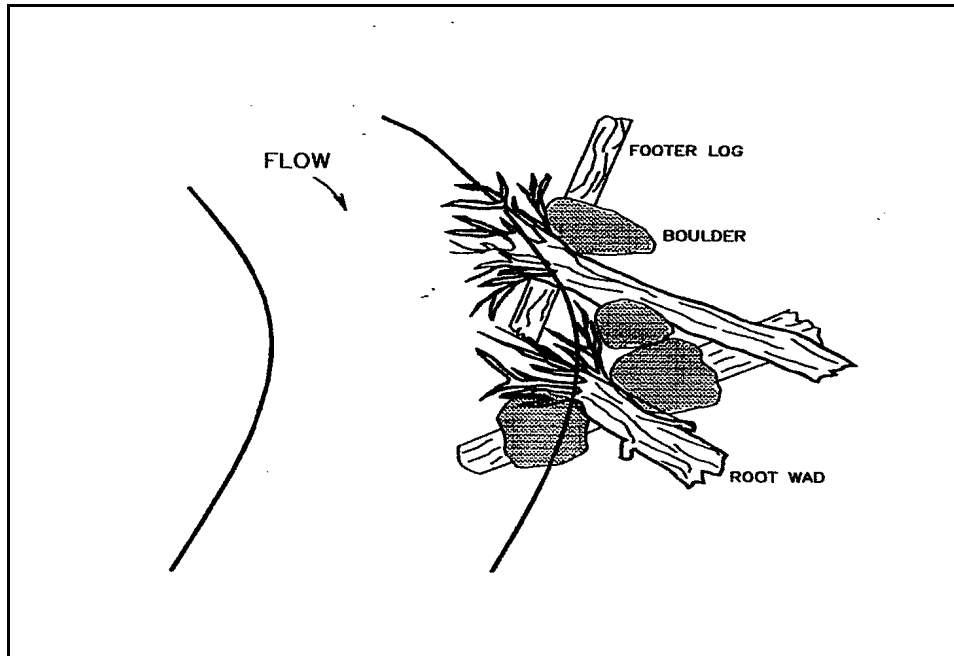

Native material revetment – Plan View. (After Rosgen, 1993)

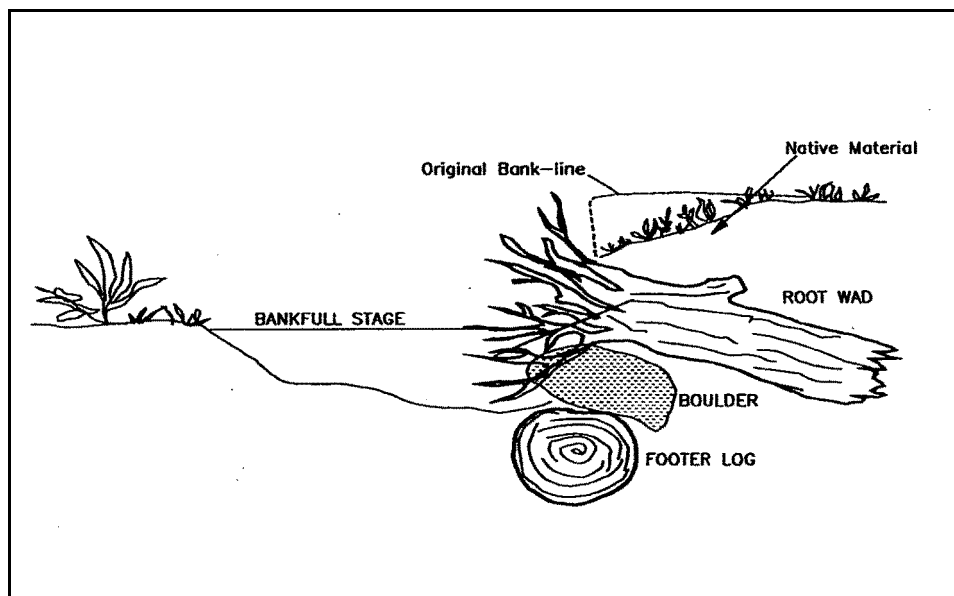

Native material revetment – Side View. (After Rosgen, 1993).

Source: California Dept. of Fish and Game (CDFG). 1998. California Salmonid Stream Habitat Restoration Manual. By Gary Flosi, et al. 3rd edition. Sacramento, CA.

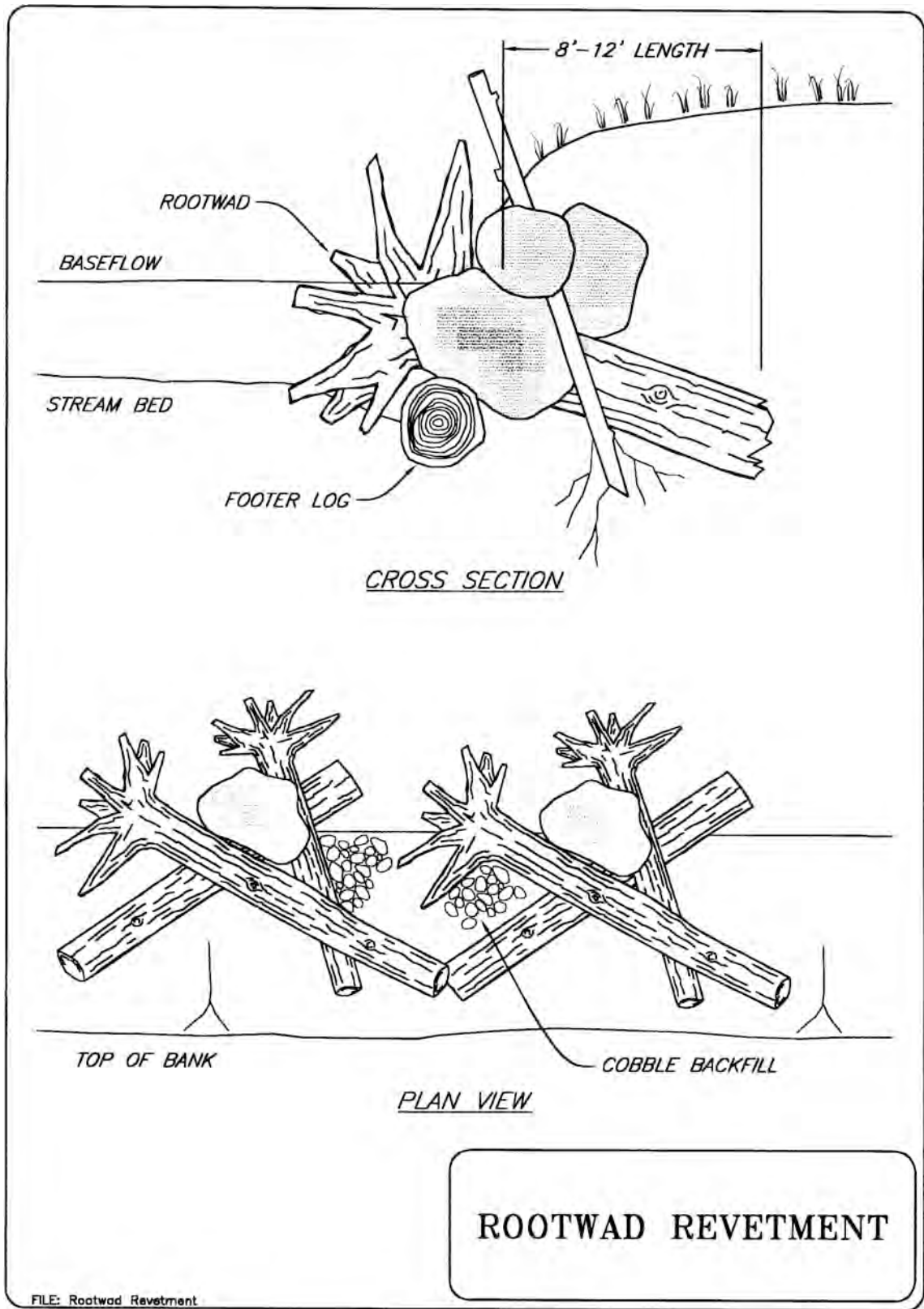

NOTES:

1. Willow pole planting and brushlayering shall be installed during bank grading and riprap placement to ensure good contact with 'native ground' and soil fill.
2. Willow poles and brush layers shall extend down into expected soil moisture zones (vadose).
3. Cut small holes or slits in filter fabric as necessary.
4. Place soil fill (cobbles, gravel, soil) around cuttings.

Permits are required for the placement of any rock or backfill below the mean high water (MHW) line of any lake or stream.

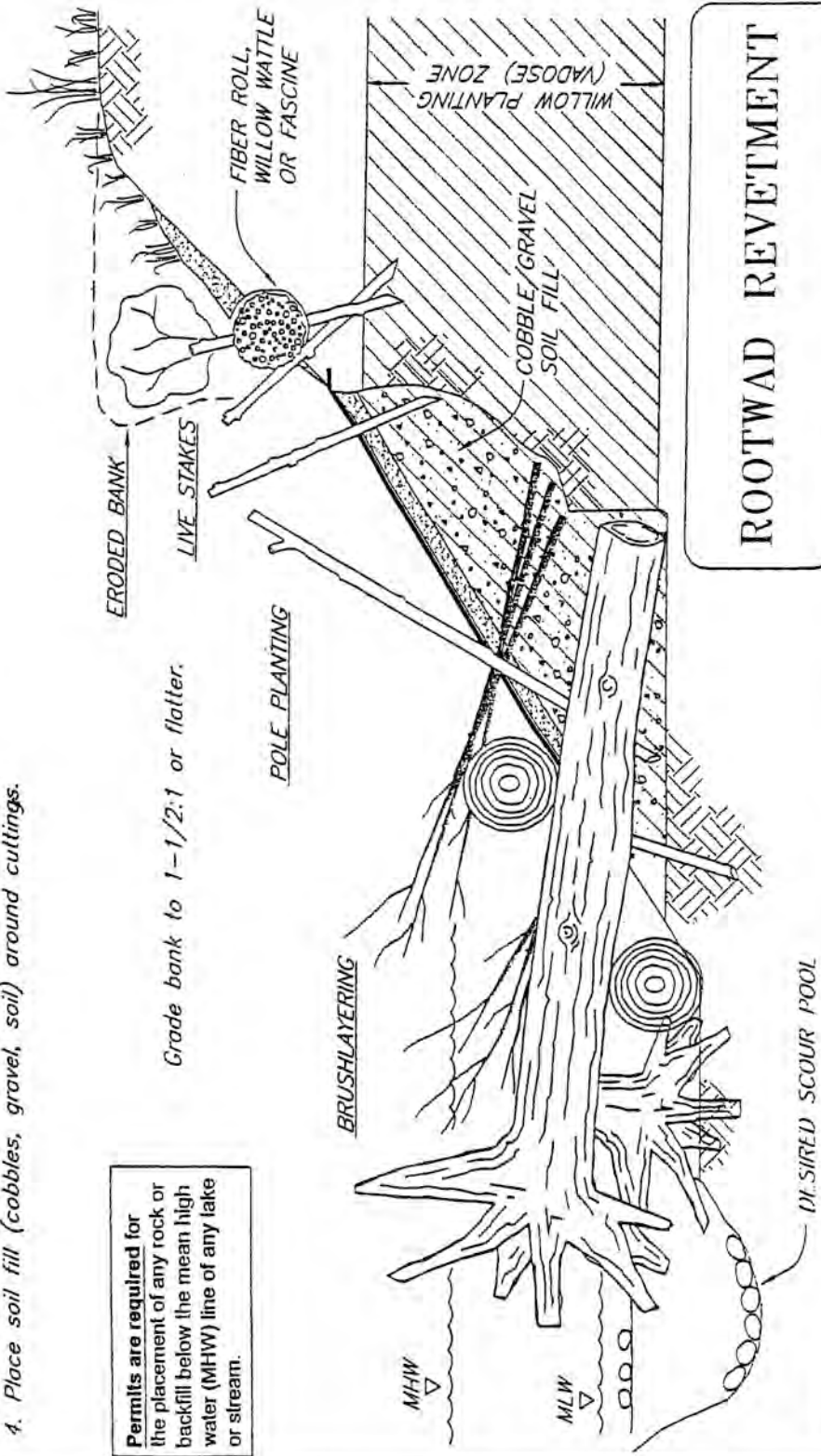

ROOTWAD REVEITEMENT

ROOTWIREY

BMP – WILLOW WALL REVETMENT

DESCRIPTION

A living revetment built along an eroding stream bank to rebuild the bank and protect it from further erosion.

APPLICATIONS

Useful for stream bank protection and re-construction in small to medium river systems. As a living system, the roots grow into the fill soil forming a flexible, porous structure. Provides valuable stream bank habitat for aquatic and terrestrial species.

LIMITATIONS

- ✓ Not suitable for deeply slumped, landslide areas.
- ✓ Drainage areas should be relatively small (generally less than 2,000 acres) with stable streambeds.
- ✓ The system must be built during low flow conditions. May need to divert water around the site and/or dewater.
- ✓ Live cuttings should be taken no earlier than the end of August and kept moist until the rainy season.
- ✓ Willows require nearly full sun conditions to be vigorous. Not to be used in heavy shade. Check to see if willows are growing in the area to confirm if this technique can be used.
- ✓ Maximum height of revetment is three feet, but can be constructed in multiple stair-step under the right moisture regime.
- ✓ Not to be used in a down-cutting stream.

CONSTRUCTION GUIDELINES

- 1) See drawing for details.
- 2) Toe of wall starts between the low flow and bank full level. Lay out post positions at 3-foot intervals to conform to bank. Upstream and downstream ends must be tucked into a stable bank feature or keyed with rock.
- 3) If toe scour is an issue, a boulder toe may be required.

BMP MAINTENANCE

- ✓ Keep soil and live cuttings moist by overhead irrigation until the rainy season begins.
- ✓ Keep livestock away from the live cuttings. If possible protect from deer for the first year.

NOTE: SEED & MULCH ALL DISTURBED AREAS.

FABRIC KEY 6" MIN.

OPTIONAL LIVE WILLOW STAKES @ 3' O.C.

LEAN POLES @ A MIN. OF 10 DEGREES TOWARDS BANK

8' LIVE WILLOW POLE 2" - 3" DIA., 3' O.C.

EXISTING TOP OF BANK

COMPACTED FILL

DENSELY PACKED WILLOW BRUSH FROM POLE TRIMMINGS.

COIR EROSION CONTROL BLANKET

1/2" - 1 1/2" DIA. WOVEN WILLOW BRANCHES

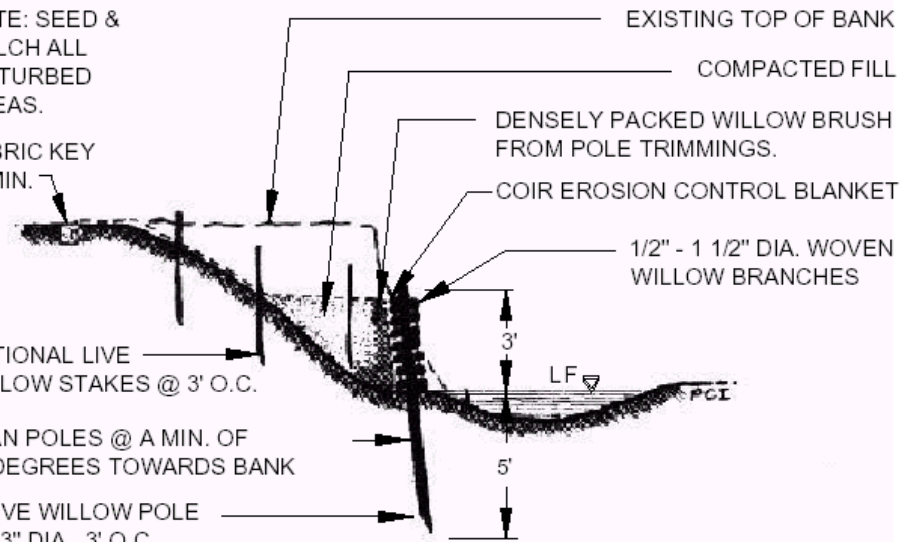

SECTION
AFTER INSTALLATION

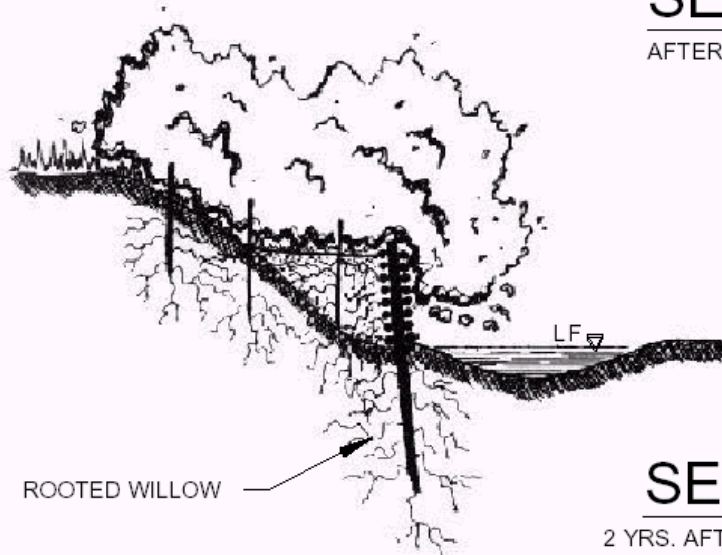

SECTION
2 YRS. AFTER INSTALLATION

CONCEPTUAL DRAWING

NOT FOR CONSTRUCTION

Source:
©Prunuske Chatham, Inc.
Occidental, CA

**WILLOW WALL
REVETMENT**

BMP - LIVE POLE DRAIN

DESCRIPTION

A live pole drain is a biotechnical and reclamation technique intended to drain excess moisture away from an unstable site. The plants used to construct the bundles (willow) will sprout and grow, with the moisture continuing to drain from the lower end. The bundles of cuttings are usually placed in shallow trenches in a manner that they intersect and collect excessive slope moisture. That excess water is then allowed to drain onto a stabilized area.

APPLICATIONS

This BMP may be used on unstable slopes, landslide repairs, and small slumping gullies.

LIMITATIONS

- ✓ Live pole drains are not effective in larger, well defined channels with concentrated flows, as the pole drains will simply plug the channel and cause more erosion as the channel adjusts to maintain capacity.
- ✓ Installation should be conducted at times of the year when weather conditions are cool and moist and the plant material is dormant.

CONSTRUCTION GUIDELINES

- 1) Install the drains in the areas of seepage, either by excavating a shallow trench or utilizing an existing drainage gully, so the drains intercept and control the excess moisture. Use wattle/fascine techniques to construct the bundles. The bundles should be tied tightly with twine or rope. Place the bundle of cuttings in the trench. Construct side drains as needed. Key the bundles into each other by jamming the ends firmly together.
- 2) Use construction stakes and/or live stakes to hold the fascines in place. Insert the stakes adjacent to the rope ties for additional support. Stake the pole drains at 3-6 foot intervals. Lightly backfill the bundles with native soil. Some twigs and branches should be left above the ground as the willow material requires some sunlight exposure to grow.

BMP MAINTENANCE

- ✓ Conduct regular inspections and maintenance, particularly during the first year.
- ✓ Immediately correct and repair failures of fill or drainage structures.

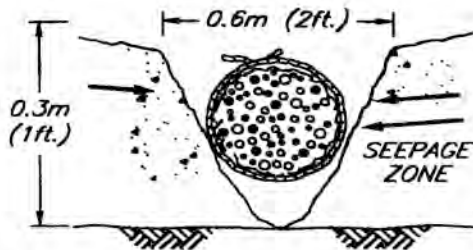

Excavate a shallow trench or utilize existing "seepage gully" (small 2ft.^2).

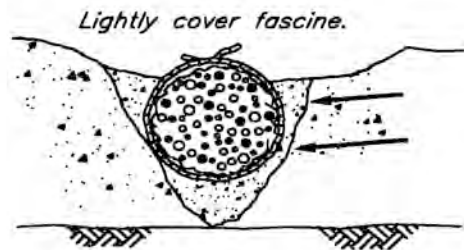

Place bundle of cuttings (fascine) in the trench and lightly backfill with native material.

NOTES:

1. Live pole drain is a biotechnical/reclamation technique which drains excess moisture from the site and provides an initial cover of woody vegetation.
2. The cuttings used to form the fascines are intended to sprout and grow while the excess moisture continues to drain from the lower end.
3. The key to successful live pole drain construction is to establish the drains in the area of seepage so they provide a controlled alternative for excess moisture to escape.

LIVE POLE DRAIN

© 2000 JOHN JOHN McCULLAH
FILE: LIVEPOLE

BMP - LIVE STAKES

DESCRIPTION

Live staking involves the insertion of live, vegetative cuttings into the ground in a manner that allows the cutting (stake) to take root and grow. This BMP is used to reduce the potential for soil to become water borne, to reduce water velocity and erosive forces, and to aid in habitat protection. Poles used in willow walls and through rip rap may be a structural application. Sprigs may be used in individual planting spots along a streambank. See *BMP- Harvesting and Handling of Woody Cuttings*.

APPLICATIONS

This BMP may be used to repair small slips and slumps, to reinforce or enhance stream banks, and to anchor and enhance the effectiveness of wattles, fascines, straw logs and other erosion control materials. It may also be used in conjunction with approved rip rap installations (vegetated rip rap).

LIMITATIONS

Do *not* use this BMP:

- ✓ where vegetation growth will interfere with maintenance or facility access.
- ✓ where vegetation growth will create safety issues.
- ✓ for immediate soil stabilization results.

CONSTRUCTION GUIDELINES

- 1) Before cutting and gathering materials, see *BMP Harvesting and Handling of Woody Cuttings* to ensure greatest success for plant material to sprout and grow.
- 2) Live staking must be implemented during the dormancy period of chosen plant species, late fall to winter (October through January is ideal in Northern Coastal California). If native willows or cottonwood are not found in the vicinity, live staking may not be a good option.
- 3) Hardwood cuttings are generally divided into three categories: Sprigs (or stakes) that are 0.75 to 1.5 inches in diameter and 36 to 48 inches long; Poles that are 1.5 to 3 inches in diameter and 5 to 8 feet long; and Branch Cuttings or Weavers which are no thinner than 1/2 inch and 6 to 12 feet long depending on the application (wattles, layering, willow wall revetments).
- 4) Don't allow stakes to dry out. Soak all cuttings in water for a minimum of 24 hours. Soaking significantly increases the survival rate of the cuttings; however, they must be planted the same day they are removed from water.

- 5) Use an iron stake or bar to make a pilot hole in firm soil. Plant the stakes butt-ends into the ground, with the leaf bud scars or emerging buds always pointing up. Be careful not to damage the buds, strip the bark or split the stake during installation. Plant stakes at random in the most suitable places at a rate of 2-5 cuttings/square yard. Do not plant the stakes in rows or at regular intervals.
- 6) Set the stake as deep as possible into the soil, preferably with 80 percent of its length into the soil and in contact with mid-summer moist soils. The stake should protrude only to a maximum of one-quarter its length above the ground level to prevent it from drying. Stakes should be cut so that cutting extends above competing herbaceous vegetation. At least 2 buds and/or bud scars shall be above the ground after planting. It is essential to have good contact between the stake and soil for roots to sprout. Tamp the soil around the cutting. Do not fertilize.

BMP MAINTENANCE

- ✓ Periodic inspection, repair and maintenance will be done in accordance with permit requirements. If no permits are required, vegetation will be monitored for the first two years or until the vegetation is established.
- ✓ Staked area may need to be watered during summer months.

BMP REMOVAL

- ✓ BMP removal is not necessary.

Typical use of willow stakes to anchor willow wattles, straw rolls, bio mats, or turf reinforcement mats.

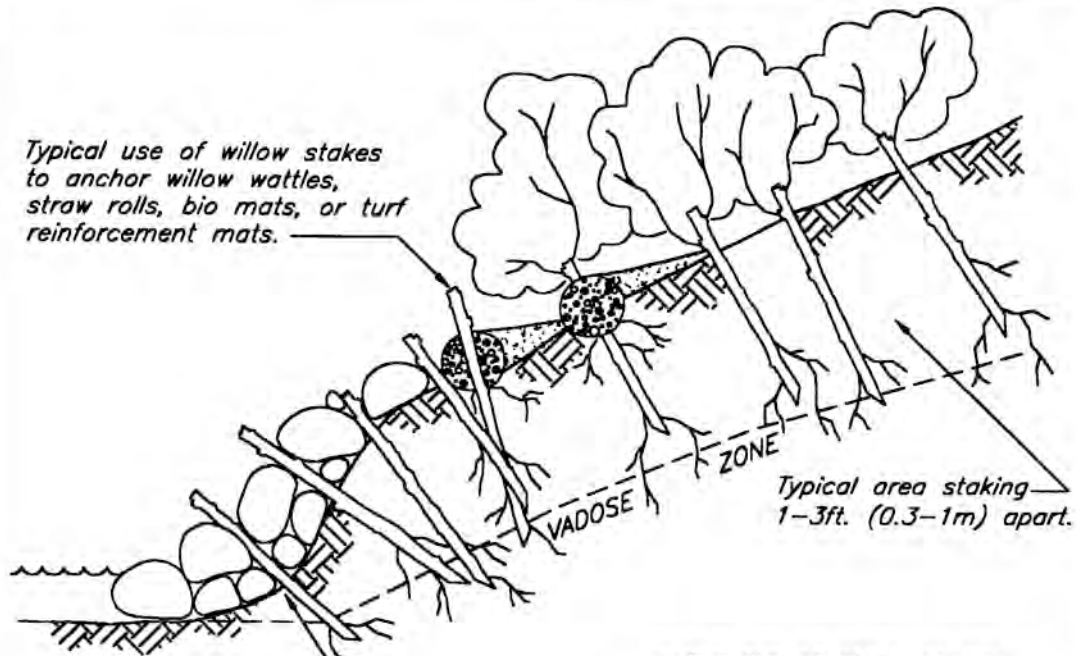

Typical area staking—
1–3ft. (0.3–1m) apart.

Typical – drive or plant willow stakes through openings in riprap or gabions.

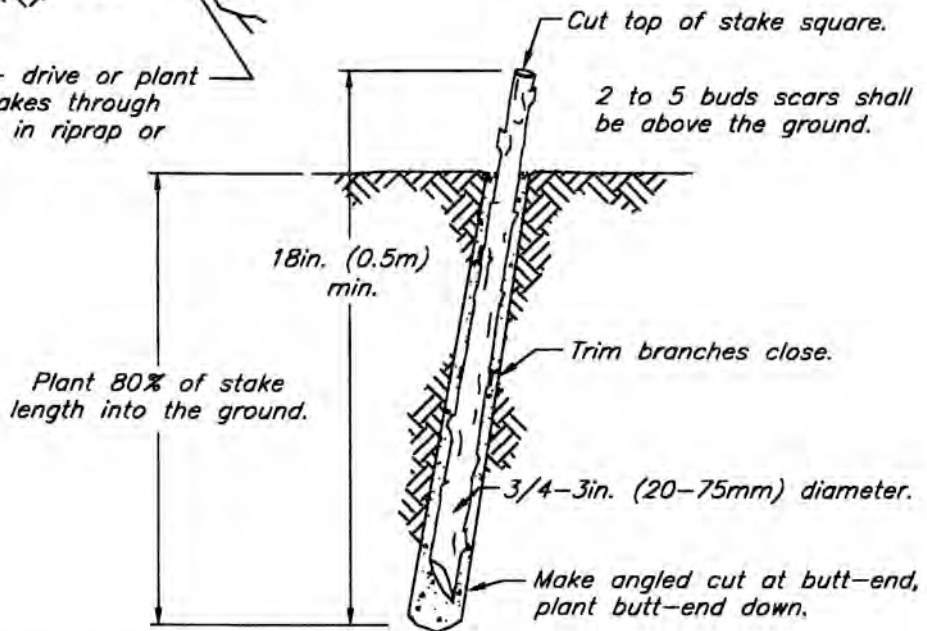

NOTES:

1. Harvest and plant stakes during the dormant season.
2. Use healthy, straight and live wood at least 1 year old.
3. Make clean cuts and do not damage stakes or split ends during installation, use a pilot bar in firm soils.
4. Soak cuttings for 24 hours (min.) prior to installation.
5. Tamp the soil around the stake.

LIVE STAKING AND JOINT PLANTING

© 2000 JOHN McCULLAH
FILE: LVSTJTPL

CONSTRUCTION TECHNIQUES

Plant poles deeply during construction of biotechnical streambank work.

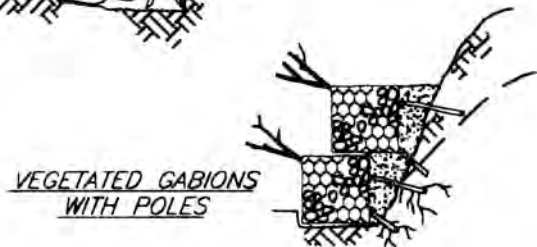
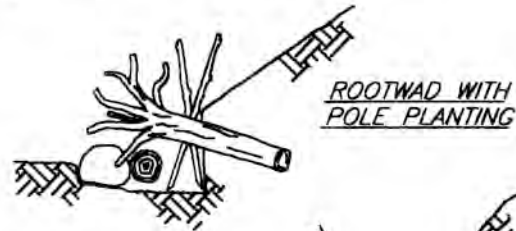
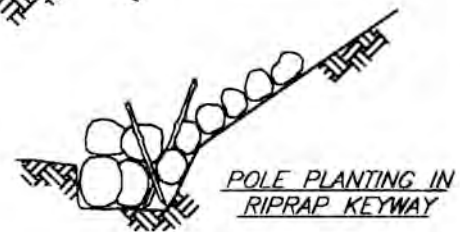
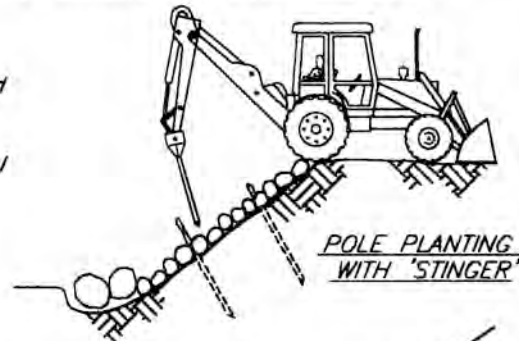
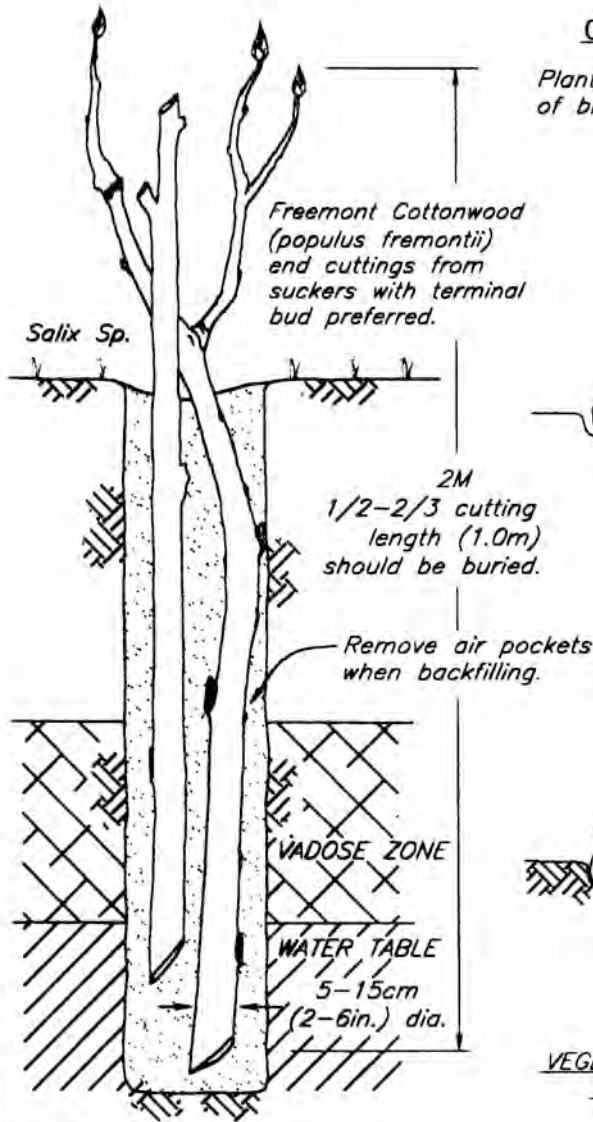

NOTES:

1. Pole cuttings of willow or cottonwood are longer and have a larger diameter than branch cuttings or live stakes.
2. Larger diameter cuttings have a greater supply of stored energy (stored photosynthesis) than smaller diameter cuttings.
3. Pole cuttings are better suited for highly erodible areas and sites with fluctuating water levels.
4. The pole cuttings should extend through the vadose zone and into the permanent water table. At least 1/2 to 2/3 of the pole should be below the ground, at least 1.0m (3 ft.), and long enough to emerge above adjacent vegetation.
5. "Muddying" - filling the hole with water and then soil to make a mud slurry can remove air pockets.

POLE PLANTING

FABRIC REINFORCED EARTH FILL WITH BRUSH LAYERING

DESCRIPTION

A constructed fill slope built with layers of live brush cuttings (usually willow) in between lifts of compacted soil, encapsulated with natural erosion control blankets or synthetic geogrids.

APPLICATIONS

Used for repairing steep slopes, slumps or stream banks above stream-forming flow conditions. Useful in restoring eroding stream banks on outside bends where laying back the bank is not feasible. Can be placed on slopes up to 1:1 or steeper with additional geotechnical analysis. Can help dry wet sites with seeps through transpiration. The willow brush helps reduce near bank stream velocities.

LIMITATIONS

- ✓ Drainage areas should be relatively small (generally less than 2,000 acres). If used on larger stream systems additional toe protection and analysis will be required.
- ✓ Stream system should not be degrading (downcutting) or the structure can be undermined.
- ✓ The system must be built during low flow conditions. May need to divert water around the site and/or dewater.
- ✓ Live cuttings should be taken no earlier than the end of August and kept moist until the rainy season.
- ✓ Willows require nearly full sun conditions to be vigorous. Not to be used in heavy shade. Check to see if willows are growing in the area to confirm if this technique can be used.
- ✓ In-stream construction requires permits from a number of regulatory agencies.

CONSTRUCTION GUIDELINES

- 1) The structure needs to be built on a competent rock or coarse gravel base with a 10:1 (H:V) back slope to counter lateral earth forces. Boulder toe protection should be installed if toe scour is a concern. Toe depth should be several feet below the thalweg of the streambed. Width of lifts will vary by site, however a minimum width of 4 feet should be used for adequate fabric and brush layer depth.

- 2) Beginning at the bankfull elevation, place 8 to 12 live branch cuttings per linear foot on top of the rock filled fabric lift with growing tips at right angles to the streamflow. Live willow cuttings should be 4 feet in length or longer. Place a few inches of select fill around willow between fabric lifts to ensure good soil contact with willow. Water in willow.
- 3) Cover this layer of cuttings with fabric leaving an overhang. Place a 12 to 24-inch layer of soil suitable for plant growth (in compacted 6" lifts) on top of the fabric. Wrap the overhanging portion of fabric over the compacted soil to encapsulate the soil in a wrap. Pull and tighten fabric toward slope and stake in place. The thickness of lifts will vary by soil type, stream shear stress, and velocity. Generally, 12-inch thick lifts are more stable than thicker lifts but are more expensive to build. Lifts typically range from 12-inch to 30-inch with 18-inch lifts being most common.
- 4) Continue this process with alternating layers of cuttings and compacted lifts wrapped in fabric until the bank is restored to its original height or meets desired grade.
- 5) Several fabric options can be used for creating the wraps. Coir twine mats (outside) with a high tensile strength can be used in conjunction with coir erosion control blanket (inside) with a dense weave to prevent soil migration through the blanket. At sites where capitol improvements are in jeopardy or higher shear stresses and velocities are calculated, synthetic geotextile materials can be used (geogrids). Willow roots will grow through the geogrid layers creating a dense matrix of willow roots bonding the structure into a single mass.

BMP MAINTENANCE

- ✓ Keep soil and live cuttings moist by overhead irrigation until the rainy season begins.
- ✓ Keep livestock away from the live cuttings. If possible protect from deer for the first year.

PDF of FABRIC REINFORCED EARTH FILL WITH BRUSH LAYERING

BMP - WATTLES/FASCINES

DESCRIPTION

Wattles and fascines are live branch cuttings, usually willows, bound together into long, tubular bundles used to stabilize slopes and stream banks. Both wattles and live fascines are true biotechnical practices. The live branches and live stakes provide the biological element while the stems, rope ties and wedge shaped wooden stakes all combine to provide the structural elements. Fascines differ from wattles in that the branch cuttings all point in the same direction in fascines, where they may point in either direction in wattles. Wattles are typically aligned on contour, where fascines are angled slightly upslope and thus tend to produce more vigorous growth.

APPLICATIONS

Wattles/fascines may be used for long slopes, road fills, road cuts, gullies or slumped areas, eroded slopes or eroding stream banks. May be used to repair small earth slips and slumps or to protect slopes from shallow slides 1-2 feet deep. Wattles/fascines may be used to stabilize entire cut or fill slopes or localized gully areas of slopes, or may be installed on newly built slopes or as a remedial action on existing slopes. This technique is useful on slopes requiring other planting materials such as woody vegetation, transplants and grasses. Wattles/fascines enhance conditions for natural invasion and the establishment of other plants from the surrounding plant community.

LIMITATIONS

- ✓ Always perform plant material harvest and installation during the dormant season, late fall through early spring.
- ✓ Where increased infiltration may cause slope failures, use fascines instead of wattles to ensure positive drainage.

CONSTRUCTION GUIDELINES

- 1) Pre-soak wattles/fascines for 24 hours, or install on the same day they are harvested and prepared. Wattles/fascines must be stored in the shade and under cover, preferably in water. Use site reconnaissance to identify species and site conditions on adjacent sites and compare their conditions to the construction site.

Planting will be more successful as the soil, site conditions, and species selected match stable and vegetated nearby sites.

- 2) Tie cuttings together to form bundles, tapered at each end, 6-30 feet in length, depending on site conditions or limitations in handling. The completed bundles should be 6-12 inches in diameter. Stagger the cuttings in the bundles so that the tips are evenly distributed throughout the length of the bundle.
- 3) Compress and tightly tie wattle/fascine bundles with rope or twine of sufficient strength and durability. Bundles shall be tied 12-15 inches apart.
- 4) General Installation Guidelines

<i>Slope (H:V)</i>	<i>Slope Length Between Wattles/Fascin es (feet)</i>
<i>1:1 to 1.5:1</i>	<i>3-4</i>
<i>1.5:1 to 2:1</i>	<i>4-5</i>
<i>2:1 to 2.5:1</i>	<i>5-6</i>
<i>2.5:1 to 4:1</i>	<i>6-8</i>
<i>3.5:1 to 4:1</i>	<i>8-12</i>
<i>4.5:1 to 5:1</i>	<i>10-20</i>

- 5) Perform any slope repairs prior to wattle/fascine installation.
- 6) Beginning at the base of the slope, dig a trench on contour. The trench shall be shallow, about ½ : what fraction? Check printout] the diameter of the wattle. The trench width will vary from 12-18 inches depending on the slope angle. Place the wattles immediately after trenching to reduce desiccation of the exposed soil. Wattles shall be staked firmly in place with one row of construction stakes on the downhill side of the wattling, not more than 3 feet apart. second row of stakes shall be placed through the wattles, near the ties, at not more than 5 feet apart. Overlap the tapered ends of adjacent wattles so the overall wattle thickness of the wattle is uniform. Two stakes shall be used at each bundle overlap such that a stake may be driven between the last two ties of each wattle.

- 7) Live stakes, if specified, are generally installed on the downslope side of the bundle. Drive the live stakes below and against the bundle between the previously installed construction stakes. Proper backfilling is essential to the successful rooting of the wattles. Backfill wattles with soil from the slope or trench above. The backfill shall be worked into the wattle interstices and compacted behind and below the bundle by walking on and working from its wattling terrace.
- 8) Repeat the preceding steps to the top of the slope. Place moist soil along the sides of the live bundle. The top of the bundle should be slightly visible when the installation is completed. Plant the slope as specified.
- 9) Seed and mulch slope, if specified. Shallow slopes, generally 3:1 or flatter may be seeded and mulched by hand. Steeper slopes can have seed applied hydraulically and the mulch should be anchored with tackifier or other approved methods.

BMP MAINTENANCE

- ✓ Conduct regular inspections and maintenance of wattle installations, particularly during the first year.
- ✓ Staked area may need to be watered during summer months.
- ✓ Immediately repair rills and gullies around or under wattles.

BMP REMOVAL

- ✓ BMP removal is not necessary.

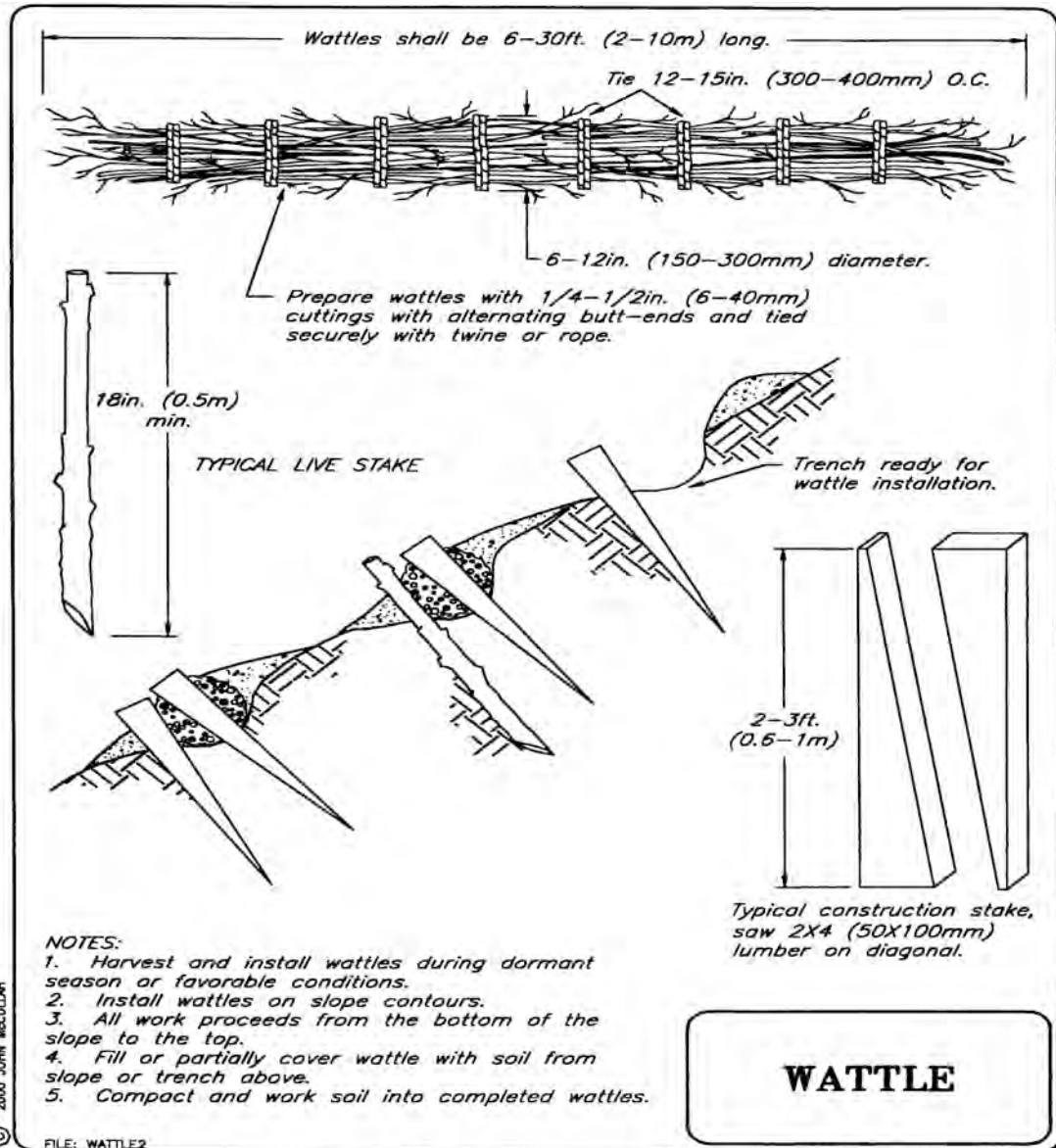

NOTES:

1. Harvest and install wattles during dormant season or favorable conditions.
2. Install wattles on slope contours.
3. All work proceeds from the bottom of the slope to the top.
4. Fill or partially cover wattle with soil from slope or trench above.
5. Compact and work soil into completed wattles.

© 2000 JOHN McCULLAH

FILE: WATTLE2

Fascines placed in trenches on slope face along shallow gradients to enhance drainage.

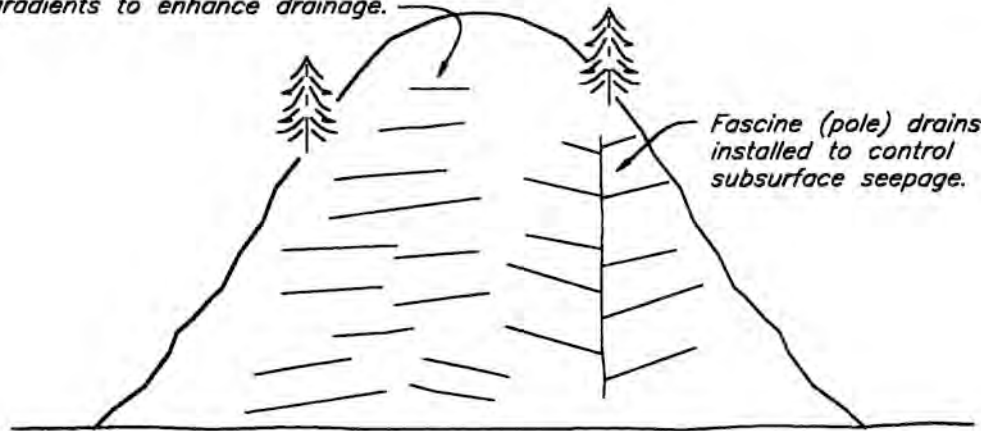

FRONT VIEW OF SLOPE

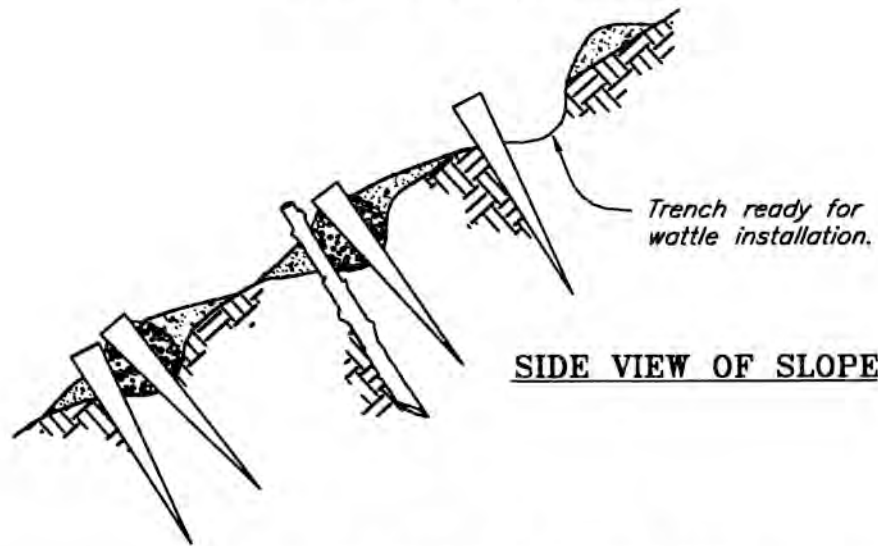

SIDE VIEW OF SLOPE

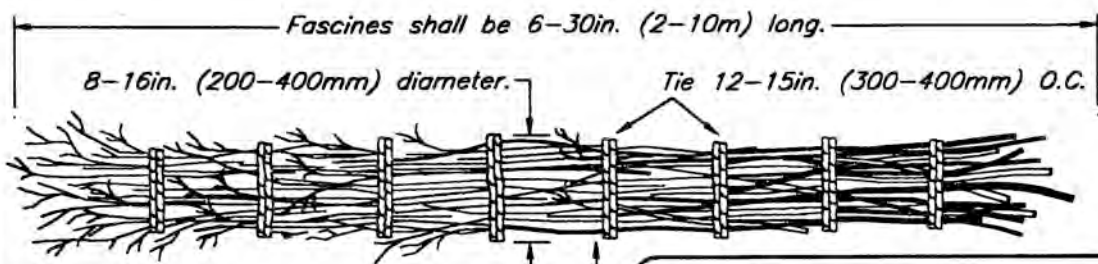

Prepare fascines with 1/4-1/2in. (6-40mm) cuttings, with all bud ends facing the same way.

LIVE FASCINE

NOT TO SCALE

© 1998 JOHN McCULLAH

FILE: LMEFASC

STREAMBANK PROTECTION HARDSCAPE BMPs

- **BOULDER/RIPRAP**..... A-221
- **STREAMBED GRAVEL** A-225
- **VEGETATED CONCRETE CRIBWALL**.....A-227

BMP - BOULDER/RIPRAP

DESCRIPTION

Riprap is a structural method appropriate for supporting slopes and/or reducing erosion in areas where biotechnical methods are unsuitable and where engineered retaining structures are unnecessary.

APPLICATIONS

Riprap may be used to stabilize steep slopes with seepage problems and/or unstable soils that need armoring to prevent sloughing. This BMP should only be used as a last resort in locations where planting or other stabilizing methods are impracticable. Riprap may also be used in combination with biotechnical BMPs. Rip rapped areas should be evaluated for finishing with topsoil and re-vegetation to improve the drainage capacity of the fill and the stability of the riprap matrix.

LIMITATIONS

- ✓ Do not use riprap as a stand-alone method of streambank stabilization.
- ✓ Obtain permits from appropriate agencies before placing any riprap below the mean high water line of any water body, or in other sensitive areas. For example, placing rock riprap in pools at the bottom of culverts is a regulated activity. Road crews frequently fill pools this way, and it is mistakenly believed to have little or no impact. Filling these pools can have a substantial impact!

CONSTRUCTION GUIDELINES

- 1) Perform live staking or pole planting during riprap placement as much as possible.
- 2) Plant native trees during construction (not after) while there is no soil in the riprap interstitial spaces.
- 10) Schedule topsoil and revegetation finish work at an appropriate time of year. Ideally install riprap when soil is moist enough to support the vegetation you plan to incorporate. Often vegetated riprap projects fail due to low soil moisture. Maintain soil moisture during prolonged dry periods to support plant growth and ensure success.
- 3) Key the toe of the riprap slope to a stable foundation at its base, and below scour
- 11) Size for 100-year event.

BMP MAINTENANCE

- ✓ Inspect riprap inspected periodically for scour or dislodged stones and repair immediately.

BMP REMOVAL

- ✓ BMP removal should not be necessary.

NOTES:

1. Willow pole planting and brushlayering shall be installed during bank grading and riprap placement to ensure good contact with 'native ground' and soil fill.
2. Willow poles and brush layers shall extend down into expected soil moisture zones (vadose).
3. Cut small holes or slits in filter fabric as necessary.
4. Place soil fill (cobbles, gravel, soil) around cuttings.
5. Place riprap carefully, do not end dump. Some damage to brush layers and willow poles is unavoidable and acceptable. Deeply planted willow material will regenerate.

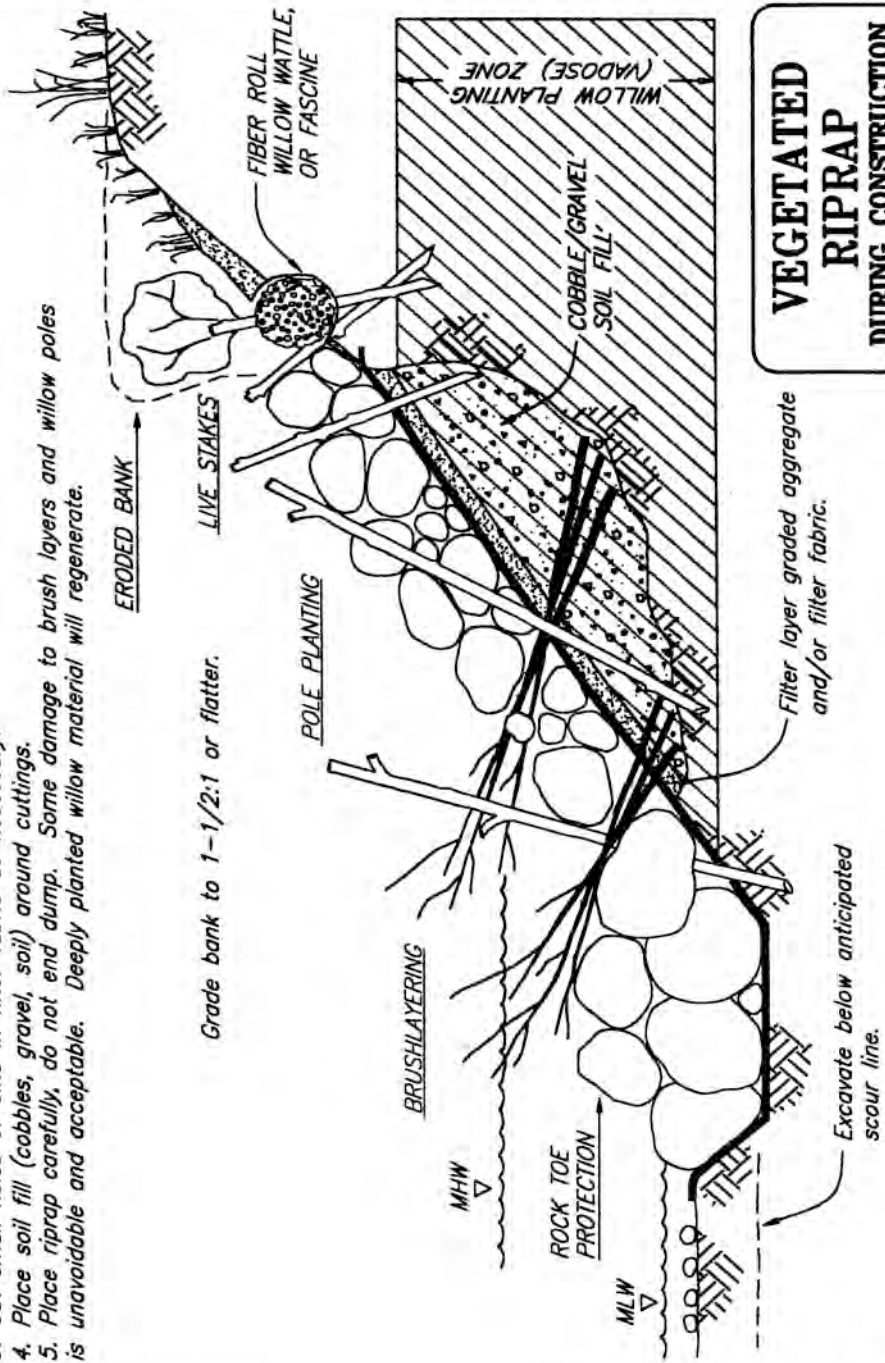

**VEGETATED
RIPRAP
DURING CONSTRUCTION**

1999 JOHN McCULLAH ©
VGRIPRAP

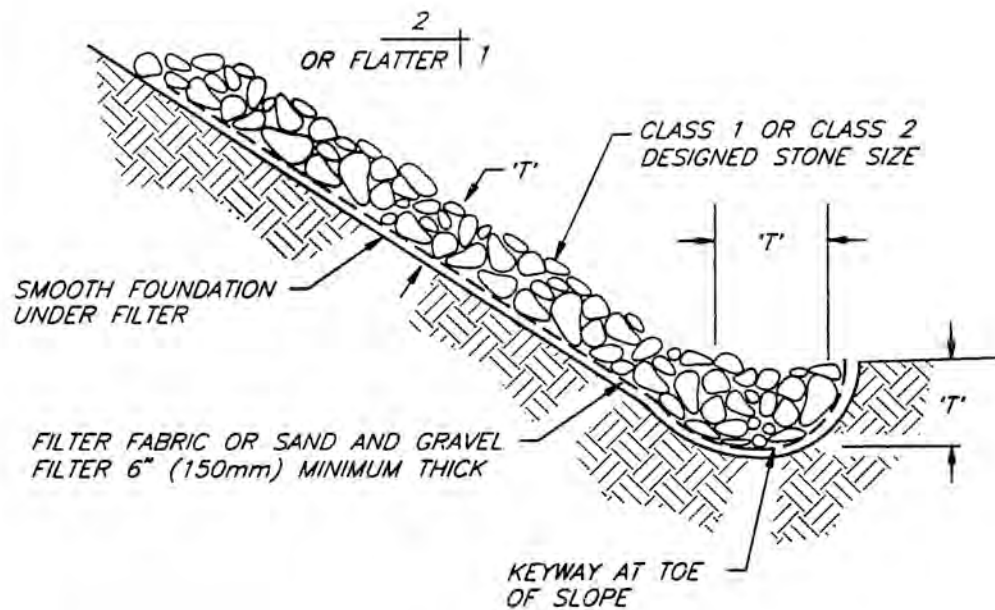

TYPICAL SECTION

NOTE:

'T' = THICKNESS: THICKNESS SHALL BE DETERMINED BY THE ENGINEER.

MINIMUM THICKNESS SHALL BE 1.5x THE MAXIMUM STONE DIAMETER,
NEVER LESS THAN 6" (150mm).

**RIPRAP
PROTECTION**

© 1994 JOHN McCULLAH

FILE: RIPRAP

BMP – STREAMBED GRAVEL

DESCRIPTION

Streambed gravel is clean, alluvial river-run, non-angular (smooth) gravel of variable sizes used for in-stream habitat protection and maintenance, or sometimes in a culvert.

APPLICATIONS

Streambed gravel can be used to provide a natural substrate for fish and for minimizing siltation in ditches and/or stormwater facilities.

LIMITATIONS

- ✓ Placing gravel in streams constitutes fill and must be permitted by the appropriate agencies.
- ✓ Gravel tends to move from the site, downstream, during winter storm run-off.
- ✓ When used as a bedding underneath a culvert, gravel may allow piping of water under the culvert.
- ✓ In some regions, river-run alluvial gravel can be difficult to acquire.

CONSTRUCTION GUIDELINES

- 1) Place gravel in accordance with applicable design and permit conditions.
- 2) Check gravel gradation to ensure it meets design specifications.
- 3) If gravel has excessive fines, wash gravel off-site (at a location where washed water cannot enter watercourses, streams or wetlands) until it runs clear.
- 4) Haul material in clean truck bed.
- 5) Dump cleaned rock onto tarped area on-site.
- 6) Place a cover and berm around clean rock stockpiles. Re-wash rock before using if it becomes dirty.

BMP MAINTENANCE

- ✓ Replace as needed

BMP REMOVAL N/A

BMP - VEGETATED CONCRETE CRIBWALL

DESCRIPTION

A vegetated concrete cribwall consists of a hollow, box-like interlocking arrangement of concrete beams filled with suitable backfill material and layers of live branch cuttings that root inside the crib. The roots of the cuttings will eventually behave as a coherent gravity structure itself.

APPLICATIONS

Vegetated concrete cribwalls are used for the stabilization of embankments and road cuts. They are helpful at the base of slopes where a low toe-wall can be used to reduce the steepness of a slope and stabilize the toe. Vegetation incorporated within the cribwalls has a more natural appearance and is less visually intrusive than a structural treatment alone. Vegetated cribwalls also minimize problems with graffiti and defacement of retaining walls, and they avoid encroachment on limited rights-of-way by use of a more vertical structure.

LIMITATIONS

- ✓ Design and construction of very high cribwalls should be approved by a qualified geotechnical engineer.
- ✓ Place crib walls below scour.
- ✓ Engineer for at least a 100-year event.

CONSTRUCTION GUIDELINES

- 1) Vegetated concrete crib walls must be designed to withstand expected lateral earth forces and must satisfy external stability requirements, as well as meet internal stability from shear stress, bending, and compression. Commercial crib wall systems and standard designs should satisfy these requirements.

BMP MAINTENANCE

- ✓ Check cribwalls periodically to ensure slope stability.
- ✓ Vegetation may need to be periodically trimmed.

BMP REMOVAL

- ✓ Removal is not necessary.

ADDITIONAL RESOURCES

Evergreen Wall, TEC-TON Enterprises, PO BOX 218, E. Pembroke, NY 14056-0218, (716) 762-8314, www.evergreenwall.com

PLANNING AND PREVENTION BMPs

- **SEASONAL PLANNING** A-231
- **SMALL SPILL KIT** A-237
- **LARGE SPILL KIT** A-239

BMP – SEASONAL PLANNING

DESCRIPTION

The purpose is to protect aquatic resources and fisheries to the greatest extent possible through scheduling and sequencing of construction activities with the implementation of erosion and sediment control measures. Minimize the amount and duration of soil exposed to erosion by wind, rain, runoff, and vehicle tracking.

APPLICATIONS

All projects involving land-disturbing activities. Sequencing to minimize land disturbance during the rainy season.

CONSTRUCTION GUIDELINES

- 1) Obtain all required permits well before beginning of construction as unforeseen permitting delays and requirements may require drastic delays in scheduling.
- 2) Create a timetable incorporating water quality and erosion control measures into construction plans.
- 3) Avoid working between October 15 and April 1st to limit impacts during critical periods for aquatic species during the wet season.
- 4) Schedule work to minimize the extent of site disturbance at any one time. Where appropriate, incorporate staged revegetation of graded slopes as work progresses.
- 5) Schedule establishment of permanent vegetation including appropriate planting time and maintenance.
- 6) Maintain year-round sediment control practices even during dry months when unexpected changes in weather could cause a discharge into waterways.
- 7) Plan enough time before rainfall to allow for effective use of vegetation or other soil stabilization methods.

BMP MAINTENANCE

- ✓ During construction, check the schedule frequently and change the schedule to accommodate changes to the work plan.
- ✓ Monitor the weather forecast for rainfall and adjust the construction schedule to allow the implementation of soil stabilization and sediment controls prior to the onset of rain.
- ✓ Be prepared year-round to deploy soil stabilization and sediment control practices. Keep the site stabilized year-round, retain and maintain rainy season sediment trapping devices in operational condition.

SEASONAL RESTRICTIONS BY SPECIES Taken from Mitigation Measures, Monitoring and Reporting Program for the 2005 Fisheries Restoration Grant Program –Appendix B; Dept. of Fish and Game Regional General Permit/Neg. Dec. for Fisheries Restoration Grant projects.

- 1) To avoid impacts to aquatic habitat the activities carried out in the restoration program typically occur during the summer dry season.
 - a) Work around streams is restricted to the period of June 15 through November 1 or the first rainfall. This is to take advantage of low stream flow and avoid the spawning and egg/alevin incubation period of salmon and steelhead.
 - b) Upslope work generally occurs during the same period as stream work. Road decommissioning and other sediment reduction activities are dependent on soil moisture content. Upslope projects do not have seasonal restrictions in the Incidental Take Statement but work may be restricted at some sites to allow soils to dry out adequately. In some areas equipment access and effectiveness is constrained by wet conditions.
 - c) The permissible work window for individual work sites will be further constrained as necessary to avoid the nesting or breeding seasons of birds and terrestrial animals. At most sites with potential for raptor (including northern spotted owls) and migratory bird nesting, if work is conditioned to start after July 31, potential impacts will be avoided and no surveys will be required. For work sites that might contain nesting marbled murrelets, the starting date will be September 15 in the absence of surveys. The work window at individual work sites could be advanced if surveys determine that nesting birds will not be impacted.
 - d) For restoration work that could affect swallow nesting habitat (such as removal of culverts showing evidence of past swallow nesting), construction will occur after August 31 to avoid the swallow nesting period. Alternatively, the suitable bridge nesting habitat will be netted before initiation of the breeding season to prevent nesting. Netting must be installed before any nesting activity begins, generally prior to March 1. Swallows must be excluded from areas where construction activities cause nest damage or abandonment.
 - e) Planting of seedlings shall begin after December 1, or when sufficient rainfall has occurred to ensure the best chance of survival of the seedlings, but in no case after April 1.

Coho Salmon (*Oncorhynchus kisutch*), Chinook Salmon (*Oncorhynchus tshawytscha*), Steelhead (*Oncorhynchus mykiss*), and Coast Cutthroat Trout (*Oncorhynchus clarki clarki*)

- 1) Project work within the wetted stream shall be limited to the period between June 15 and November 1, or the first significant fall rainfall. This is to take advantage of low stream flows and to avoid the spawning and egg/alevin incubation period of salmon and steelhead. Whenever possible, the work period at individual sites shall be further limited to entirely avoid periods when salmonids are present (for example, in a seasonal creek, work will be confined to the period when the stream is dry).

California Red-Legged Frog (*Rana aurora draytonii*)

- 1) Ground disturbing activities in potential red-legged frog habitat will be restricted to the period between July 1 and October 15.

California Freshwater Shrimp (*Syncaris pacifica*)

- 1) Ground disturbing activities in potential shrimp habitat shall be restricted to the period between July 1 and November 1.

Least Bell's Vireo (*Vireo bellii pusillus*)

The potential exists for the noise from heavy equipment work and the harvesting of willow branches for revegetation at these sites to disrupt vireo nesting. To avoid this potential impact, the following mitigation measures will be implemented:

- 1) Work shall not begin within one quarter mile of any site with known or potential habitat for the Least Bell's Vireo until after September 15.
- 2) Harvest of willow branches at any site with potential habitat for the Least Bell's Vireo will not occur between March 1 and September 15.
- 3) The work window at individual work sites may be modified, if protocol surveys determine that nesting birds do not occur within 0.25 miles of the site during the breeding season.

Marbled Murrelet (*Brachyramphus marmoratus*)

The marbled murrelet is listed as endangered under CESA and threatened under ESA. Activities to protect and restore habitat will not remove or degrade suitable habitat for marbled murrelets, however nesting birds could be disturbed by the noise from heavy equipment required for projects such as culvert removal or placement of large woody debris.

- 1) Adverse effects can be avoided by limiting heavy equipment work within 0.25 mile of marbled murrelet habitat to the period between September 16 and March 23.
- 2) Work shall not begin within 0.25 mile of any site with occupied or un-surveyed suitable marbled murrelet habitat between March 24 and September 15.
- 3) The work window at individual work sites near suitable habitat may be modified, if protocol surveys determine that habitat quality is low and occupancy is very unlikely.

Northern Spotted Owl (*Strix occidentalis caurina*)

The northern spotted owl is listed as threatened under ESA. Restoration activities should not alter habitat for northern spotted owls, however nesting birds could be disturbed by the noise from heavy equipment during projects such as culvert removal or placement of large woody debris. Direct injury or mortality of owls is not an issue. The potential exists for heavy equipment work at these sites to disturb spotted owl nesting. To avoid this potential effect, the following mitigation measures will be implemented:

- 1) Disturbance can be avoided by limiting heavy equipment work within 0.25 miles of suitable spotted owl habitat to the period between August 1 and January 31.
- 2) Work at any site within 0.25 miles of suitable habitat for the northern spotted owl will not occur from February 1 to July 31.
- 3) The work window at individual work sites may be advanced prior to July 31, if protocol surveys determine that suitable habitat is unoccupied.

Willow Flycatcher (*Empidonax traillii*)

The potential exists to affect suitable habitat for the willow flycatcher by the harvesting of willow branches for riparian planting and construction of live willow mattresses and live willow walls. The potential also exists for the noise from heavy equipment work or harvesting of revegetation material at project sites to disrupt willow flycatcher nesting. To avoid this potential impact, the following mitigation measures will be implemented:

- 1) Heavy equipment work shall not begin within one quarter mile of any site with known or potential habitat for the *willow flycatcher* until after August 31. Heavy equipment work shall not begin within one quarter mile of any site with known or potential habitat for the *southwestern willow flycatcher* until after September 15.
- 2) Harvest of willow branches at any site with potential habitat for the willow flycatcher will not occur between May 1 and August 31. Harvest of willow branches at any site with potential habitat for the *southwestern willow flycatcher* will not occur between May 1 and September 15.
- 3) The work window at individual work sites may be modified, if protocol surveys determine that nesting birds do not occur within 0.25 miles of the site during the breeding season.

Least Bell's Vireo (*Vireo bellii pusillus*)

The potential exists for the noise from heavy equipment work and the harvesting of willow branches for revegetation at these sites to disrupt vireo nesting. To avoid this potential impact, the following mitigation measures will be implemented:

- 1) Work shall not begin within one quarter mile of any site with known or potential habitat for the Least Bell's Vireo until after September 15.
- 2) Harvest of willow branches at any site with potential habitat for the Least Bell's Vireo will not occur between March 1 and September 15.
- 3) The work window at individual work sites may be modified, if protocol surveys determine that nesting birds do not occur within 0.25 miles of the site during the breeding season.

Point Arena Mountain Beaver (*Aplodontia rufa nigra*)

- 1) No operation of noise generating equipment (e.g. chainsaws) within 100 feet of active burrows during the breeding season (December 15 – June 30).
- 2) No operation of mechanical equipment (e.g. backhoes, excavators) within 100 feet of active burrows during the breeding season (December 15 – June 30), and within 50 feet the remainder of the year.
- 3) No ground disturbance (e.g. dumping of boulders) within 500 feet of active burrows during breeding season, and within 100 feet the remainder of the year. No severe ground disturbance (e.g. driving of bridge piles, blasting) within 500 feet of active burrows at any time.

BMP – SMALL SPILL KIT

DESCRIPTION

Commercial emergency response spill kits contain absorbent material to contain and clean up small chemical spills.

APPLICATIONS

Spill kits typically have the capacity to help clean up 6 to 14 gallon size spills. Use wherever petroleum products, concrete and chemical pollutants may spill. Around heavy machinery with hydraulic fluids and at any on-site designated refueling/servicing areas. Also used to clean up chemical fertilizers and pesticides.

LIMITATIONS

- ✓ Assess the needs of project to match the type and size of kits to ensure proper materials in case of emergency.
- ✓ For larger spills, see “Spill - Large” BMP. Large spills must be reported immediately.

CONSTRUCTION GUIDELINES

- 1) Kits may contain absorbent pads, socks, wattles, pillows, disposal bags, warning labels, and emergency response guidebook.
- 2) Use appropriate personal protective equipment.
- 3) Deploy materials to stop the flow into the ground or off-site. This may require constructing an emergency earthen berm.
- 4) Repair source of leak (containers or machinery) or remove from site.
- 5) Dispose of contaminated materials and soil in an approved location.
- 6) Report all significant spills.

BMP MAINTENANCE

- ✓ Replace spill kits or parts of spill kits when used.

BMP REMOVAL

- ✓ Dispose of contaminated materials in an approved location.



UNIVERSAL NON-AGGRESSIVE 20-GALLON OVERPACK SPILL KIT

DESCRIPTION

1 20-gal Overpack Kit 25 lbs. Absorbs 14 gallons of Oil, Coolants, Solvents & Water, 1-3" x 10' Socks, 4-3" x 4' Socks, 2-18" x 18" Pillows, 15-16" x 20" Heavy-Wt. Pads, 5-Temporary Disposal Bags, 1-Emergency Response Guidebook, 3 Warning & Disposal Labels

Source:
www.dawginc.com/spill-kits/spill-kits.asp

SMALL SPILL KIT

BMP – LARGE SPILL KIT

DESCRIPTION

A palletized boxed spill kit capable of absorbing 148 gallons or more.

APPLICATIONS

Used as first line of defense on larger spills. Immediately notify local emergency response agency by dialing 911. Use wherever petroleum products and/or concrete and chemical pollutants may spill. Around heavy machinery with hydraulic fluids and at any on-site designated refueling/servicing areas. Also used to clean up chemical fertilizers and pesticides.

LIMITATIONS

- ✓ Assess the needs of project to match the type and size of kits to ensure proper materials in case of emergency.
- ✓ Determine whether or not materials are too hazardous to be contained by on site personnel. May require a certified HazMat team.

CONSTRUCTION GUIDELINES

- 1) Follow guidelines in the Stormwater Pollution Prevention Plan for the project.
- 2) Notify the local emergency response agency by dialing 911. Also notify other appropriate local officials. All necessary emergency telephone numbers should be available at the construction site.
- 3) Notify the Governor's Office of Emergency Services Warning Center at (800) 852-7550.
- 4) For spills of federal reportable quantities, notify the National Response Center at (800) 424-8802.
- 5) Notification should first be made by telephone and followed up with a written report as soon as possible.
- 6) If safe, stop the source of the spill and contain the spill's spread. Use appropriate personal protective equipment found in the spill kit (rubber gloves, safety glasses).
- 7) A spill cleanup contractor or HazMat team should be contacted immediately.
- 8) Construction personnel should not attempt to initiate cleanup until appropriate and qualified staff have arrived at the site.
- 9) Other agencies which may need to be consulted include local fire, police, and public works departments, the U.S. Coast Guard, the California Highway Patrol, the California Department of Toxic Substance Control, California Division of Oil and Gas, Cal/OSHA, etc.

BMP MAINTENANCE

- ✓ Replace spill kits or parts of spill kits when used.

BMP REMOVAL

- ✓ Dispose of contaminated materials in an approved location.



HEAVY DUTY CARDBOARD BOX SPILL KIT

DESCRIPTION

1 Kit Container 239 lbs. Absorbs 148 gallons of Oil, Coolants, Solvents & Water. Dawg Products: 20-3" x 10' Socks, 60-3" x 4' Socks, 16-18" x 18" Pillows, 200-16" x 20" Heavy Wt. Pads, 2 Suits, 2 Pr-Gloves, 2 Pr-Goggles, 30-Temporary Disposal Bags, 1-Emergency Response Guidebook, 168 Wipes, 1 Container Box (Dim: 36" Cube)

Source:
[www.dawginc.com/spill-kits/
spill-kit-box-container.asp](http://www.dawginc.com/spill-kits/spill-kit-box-container.asp)

LARGE SPILL KIT

GLOSSARY

Acronyms.....3

Definition of Terms.....5

B

Acronyms

Here is a list of the “alphabet soup” of agencies, laws, programs, and materials that may need translation.

ABAG	Association of Bay Area Governments
AC	Asphalt – concrete
BA	Biological Assessment (under ESA)
BASMAA	Bay Area Stormwater Management Agencies Association
BLM	Bureau of Land Management
BMP	Best Management Practice
BO	Biological Opinion (under ESA)
CAL-EPA	California Environmental Protection Agency
CCC	California Coastal Commission
CCCESU	Central California Coast Evolutionary Significant Unit
CDF	California Dept. of Forestry and Fire Protection
CEQA	California Environmental Quality Act
CESA	California Endangered Species Act
CFR	Code of Federal Regulations
CMA	Calcium Magnesium Acetate (for ice control)
CMP	Corrugated Metal Pipe culvert
COE	Corps of Engineers, U.S. Army
CWA	Clean Water Act
CZMA	Coastal Zone Management Act
DFG	California Dept. of Fish and Game
DOT	Department of Transportation (county, state or federal)
DRC	Ditch Relief Culvert
EIR	Environmental Impact Report (under State CEQA)
EIS	Environmental Impact Statement (under Federal NEPA)
EPA	U.S. Environmental Protection Agency
ERFO	Emergency Relief for Federally Owned Roads
ESA	Endangered Species Act
ESU	Evolutionarily Significant Unit
FHWA	Federal Highway Administration
HBRR	Highway Bridge Rehabilitation or Replacement
HCP	Habitat Conservation Plan
LCP	Local Coastal Plan
LOP	Limited Operating Period
LWD	Large Woody Debris
NFPA	National Fire Protection Association
NMFS	National Marine Fisheries Service (former name for NOAA Fisheries)
NOAA	National Oceanic and Atmospheric Administration
NOAA FISHERIES-	The branch of NOAA responsible for fisheries protection and restoration
NPDES	National Pollution Discharge Elimination System

NRCS	Natural Resource Conservation Service
NWP	Nationwide General Permit (under CWA)
ODOT	Oregon Dept. of Transportation
RCD	Resource Conservation District
RGP	Regional General Permit (under CWA)
RWQCB	California Regional Water Quality Control Board
SHPO	State Historic Preservation Office
SLC	State Lands Commission
SMARA	Surface Mining and Reclamation Act (California)
SPCC	Spill Prevention Control and Countermeasure plan
STIP	State Transportation Improvement Project
SWP	Storm Water Permit
SWRCB	State Water Resources Control Board
TMDL	Total Maximum Daily Load (under Clean Water Act)
USA	Underground Service Alert
USACE	U.S. Army Corps of Engineers (see COE)
USDOT	U.S Dept. of Transportation
USFS	U.S. Forest Service
USFWS	U.S. Fish and Wildlife Service
WDR	Waste Discharge Requirements

Definition of Terms

Abandoned road – A road which is no longer maintained. An abandoned road may or may not still be driveable and may or may not be overgrown with vegetation. [See also *Road abandonment*.]

Accelerated erosion – Erosion that has been caused directly or indirectly by human activities or land management. Typically thought of as erosion which is not “natural” or that which is in excess of that which would have naturally occurred.

Active channel width - See *Ordinary High Water Mark*. Term used by California DFG in its “Culvert Criteria for Fish Passage”.

Active road – A road that is part of the overall road network that needs to be actively inspected and maintained.

Adaptive management – Learning from experience by adapting management practices through the feedback received through monitoring.

Alevin – A juvenile salmonid fish in the early phase, recently emerging from the egg and still carrying a yolk sac.

Anadromous fish – (“*a-nad’-ro-mus*” ; to run upward) - fish that are born and rear in freshwater, move to the ocean to grow and mature, and return to freshwater to reproduce. Salmon, steelhead, and lamprey eel are examples.

Angle of repose – The steepest slope angle at which a material will freely stand without failing or sliding downslope. For material without cohesion, such as sand, the angle is about 33 degrees. It is steeper for cohesive materials. Slopes which are steeper than the angle of repose are likely to be unstable.

Armoring – Protective coverings or structures used to dissipate the erosive energy of water. Aprons and rip-rap are types of armoring.

Bankfull discharge – The stream discharge that just fills the stream to its banks, and which usually occurs approximately every two years on average.

Bearing surface – The driving surface of the road. Road rocking is a common method of increasing the load bearing capacity of the road surface if the subgrade soils are relatively weak.

Berm – A curb or dike constructed to control water and prevent roadway runoff waters from discharging onto roadside slopes and/or to provide material for subsequent road maintenance.

Best Management Practices (BMPs) – A technique, or series of techniques, which is the best known practice available to be effective in protecting water quality and stream habitat.

Borrow site – Locations on the landscape where sand, gravel, and/or rock is excavated for use in road construction activities elsewhere in the watershed.

Buffer strip – An area or strip of land adjacent to a stream containing relatively undisturbed vegetation that acts as a filter or buffer for erosion and runoff from upslope roads or other land management activities.

Check dam (straw bale) – A temporary structure used to contain eroded soil from leaving a disturbed or construction site. Straw bale dams quickly decompose and will usually not provide sediment storage or protection for more than a single season.

Chinook salmon – An anadromous fish species also known as “king salmon”.

CMP – Corrugated metal pipe culvert, often used synonymously with culvert. Metal culverts are typically made from galvanized steel or aluminum.

Coho salmon – An anadromous fish species also known as “silver salmon”.

Controllable – Erosion that would reasonably respond to cost-effective mitigation.

Cross-drain – A culvert, rolling dip, water bar, or outslope area that drains water across a road from an inboard ditch or water collection area. Cross-road drains are more substantial and deeper than conventional waterbars used to drain forest and ranch roads, and are steeper and more abrupt than rolling dips. Well constructed cross-drains will often be deep enough to prevent vehicular access to an area and are typically installed on roads which are being closed permanently or for several years. Cross-road drains are typically constructed (excavated) using a tractor, an hydraulic excavator, or a backhoe.

Culvert – A transverse drain, usually a metal pipe, set beneath the road surface which drains water from the inside of the road to the outside of the road. Culverts are used to drain ditches, springs, and streams across the road alignment.

Cutslope (cutbank) – The artificial face or slope cut into soils or rock along the inside of a road.

Danger tree – Trees or snags, on or near the highway, that are found to be weakened, unsound, undermined, leaning, or exposed so they may fall across the road. When permission to remove the trees cannot be obtained, it is necessary to trim and do whatever else is reasonable to alleviate the hazard.

Debris flow – A rapidly moving mass of rock fragments, soil and mud, with more than half of the particles being larger than sand size. In contrast to debris slides, debris flows are usually saturated with water.

Debris slide – A slow to rapid slide, involving downslope translation of relatively dry and predominantly unconsolidated materials, with more than half of the particles being larger than sand size.

Debris torrent – Rapid movement of a large quantity of materials (wood and sediment) down a stream channel during storms or floods. This action generally occurs in smaller, steep stream channels and results in scouring of the streambed.

Dewatering – The temporary diversion of water away from a work site to protect water quality and allow progression of work. Diversion is accomplished with coffer dams, pipes, or other means. Water is removed from the work site only, and not the entire stream or body of water.

Ditch relief culvert – A drainage structure or facility which will move water from an inside road ditch to an outside area, beyond the outer edge of the road fill.

Diversions potential - Road stream crossing that has the potential to divert flow from a plugged culvert down the length of the road surface, rather than directly across the culvert fill and into its natural drainage channel. This potential carries the risk of causing soil erosion and sediment delivery.

Downspout – A flume or trough attached to a culvert outlet to transport water beyond the erosive road fill to a stable, armored catchment area in order to prevent erosion. Culverts that are placed at the base of the road fill discharge directly into the natural channel or hillslope and usually do not require a downspout.

Drainage basin – See: *Watershed*.

Drainage structure – A structure installed to control, divert or to cross over water, including but not limited to culverts, bridges, ditch drains, fords, waterbreaks, outsloping, and rolling dips.

Drop inlet – A vertical riser on a culvert inlet, usually of the same diameter as the culvert, and often slotted to allow water to flow into the culvert as streamflow rises around the outside. Drop inlets are often used on stream or ditch relief culverts where sediment or debris would otherwise threaten to plug a traditional horizontal inlet.

Emergency – “A situation which would result in an unacceptable hazard to life, a significant loss of property, or an immediate, unforeseen, and significant economic hardship if corrective action requiring a permit is not undertaken within a time period less than the normal time needed to process the application under standard.” (COE Regulations); “A situation involving an act of God, disasters, casualties, national defense or security emergencies, etc., and includes response activities that must be taken to prevent imminent loss of human life or property.” (ESA rules, 50 CFR 402.05); “A sudden, unexpected occurrence, involving a clear and imminent danger, demanding immediate action to prevent or mitigate loss of, or damage to, life, health, property or essential public services. Emergency includes such occurrences as fire, flood, earthquake, or other soil or geologic movements, as well as such occurrences as riot, accident, or sabotage.” (CEQA 15359).

Emergency road maintenance – See: *Storm maintenance*.

Endangered Species – Any species which is in danger of extinction throughout all or a significant portion of its range; an official designation of the California and/or Federal Endangered Species Acts.

Endhauling – The removal and transportation of excavated material to prevent sidecast, and the storage of the material in a stable location where it cannot enter stream channels. Endhauling is usually accomplished using dump trucks, but on larger jobs may be performed by mobile scrapers.

Energy dissipator – A device or material (often rocks) used to reduce the energy of flowing water, typically used at and below culvert outlets and other drainage structures to prevent erosion.

Ephemeral streams - Streams that contain running water only sporadically, such as during and following storm events.

Equipment limitation / equipment exclusion – The terms used when the use of heavy equipment is to be limited or prohibited, respectively, for the protection of water quality, the beneficial uses of water, or aquatic habitat.

Erodible soils – Soils which are relatively prone to erosion by rain drop impact and surface runoff. Granular, noncohesive soils (such as soils derived from sand dunes or from decomposed granite (DG)) are known to be especially erodible.

Erosion – The wearing away of land surface primarily by wind or water. Erosion occurs naturally as a result of weather or runoff, but can be intensified by clearing, grading, or excavation of the land surface. Erosion usually refers to processes of surface erosion (rain drop erosion, rilling, gullyng, and ravelling) and not to mass soil movement (landsliding).

Erosion control - The act of controlling on-going erosion caused by rain drop impact, rilling, gullyng, ravelling, and other surface processes.

Erosion prevention – Preventing erosion before it has occurred. Erosion prevention is typically less expensive and more effective than erosion control.

Erosion-proof – The act of performing erosion control and erosion prevention activities which will protect a road, including its drainage structures and fills, from serious erosion during a large storm and flood.

Excess material – See *Spoil*.

Fail-safe – A term used to describe a stream crossing that has no diversion potential.

Fail soft – A fail-safe stream crossing where the dip or change in road grade occurs over the hinge line between the fill and the natural ground surface. With the road dip or low point in this location, overflow from a plugged culvert will likely result in the least possible amount of erosion. Roads which dip deeply as they cross a stream channel have smaller fills which can be eroded when culvert plugging occurs.

Fillslope – That part of a road fill between the outside edge of the road and the base of the fill, where it meets the natural ground surface.

Fill – The material that is placed in low areas, compacted, and built up to form the roadbed surface.

Filter fabric (geotextile) – A synthetic fabric manufactured and designed for use in, among others, subsurface and surface drainage applications. Filter fabric is especially useful in maintaining a separation between coarse aggregate and finer native soil particles. It comes in a number of different types (with different specifications and uses) and is used in a number of different road building settings. Manufacturer's specifications should always be consulted before using a fabric for drainage or other engineering applications.

Filter strip – See *Buffer*.

Filter windrow – A row of slash and woody debris laid and pressed down along the base of a road fill or sidecast slope to contain soil eroded from the hillslope. Filter windrows are often used to contain erosion from fillslopes and sidecast areas where a road approaches and crosses a stream channel.

Flared inlet – A culvert inlet which is flared or widened to increase its capacity and reduce the chance of inlet plugging and damage. Mitred inlets, usually made by cutting a normal culvert at an angle, are also used on ditch relief culverts to decrease inlet erosion and improve culvert efficiency. Flared inlets are attached to the normal culvert inlet using a band or bolts.

Floodplain – The land area that is covered by water from the overflow of stream channels when their banks are full. The ‘100-year floodplain’ represents the area potentially inundated for an unusual but possible flood event with the probability of occurring once every 100 years on the average.

Fluvial geomorphology – the study of water-shaped landforms. See also *Geomorphology*.

Ford (wet) – A rock, concrete or other hardened structure built on the bed of a live stream which allows vehicle passage during low flow periods.

Ford (dry) - A rock, concrete or other hardened structure built on the bed of a swale, gully or usually dry stream which allows vehicle passage during periods of low or no flow.

French drain – A trench with covered drain rock used to provide subsurface ground water transport from a wet area and discharge it in a safe and stable location. French drains are often lined with filter fabric to keep soil from plugging the drain.

Fry – A juvenile salmonid fish, between the alevin and the smolt phase, in fresh water.

Full bench road – Road construction technique where the road bench cut width equals the road running surface width and no fill is used.

Full fill road – Road construction technique in which no bench cut is made into the hillslope and the road prism is made entirely from imported fill. The ground surface must still be prepared (grubbed and bared) for the fill to bind to the underlying substrate.

Geomorphology - the study of the physical features of the surface of the earth, including their form, nature, origin, and development. See also *Fluvial geomorphology*.

Geotextile – See *Filter fabric*.

Grade-break – The location of a reversal in the slope (grade) of the road from climbing to falling, or from falling to climbing.

Grading – The act of excavating and moving soil along the road alignment to an established grade-line during road construction or reconstruction. Grading also refers to the mechanical smoothing of the road bed to maintain a free-draining, smooth traveling surface.

Ground cover – Matter that covers the soil surface, such as low growing plants, rock and rock fragments, and debris such as leaves and twigs.

Groundwater – The standing body of water beneath the surface of the ground, consisting largely of surface water that has seeped down into the earth.

Gully – An erosion channel formed by concentrated surface runoff which generally has a cross sectional area larger than one square foot (1’ deep by 1’ wide). Gullies often form where road surface or ditch runoff is directed onto unprotected slopes.

Habitat – The place where a plant or animal (including fish and other aquatic life) naturally or normally lives and grows.

Hazard Tree - Trees or snags on or near the highway that are found to be weakened, unsound, undermined, leaning, or exposed so they may fall across the highway, impair sight while driving, or damage structures.

Hazardous waste - A waste, or combination of wastes, which because of its quantity, concentration, or physical, chemical or infectious characteristics, may either cause or significantly contribute to an increase in serious irreversible illness, or pose a substantial present or potential hazard to human health or the environment when improperly treated, stored, transported, disposed of, or otherwise managed. Possesses at least one of four characteristics (ignitability, corrosivity, reactivity, or toxicity), or appears on special EPA or state lists. Regulated under the federal Resource Conservation and Recovery Act and the California Health and Safety Code.

Headcut – The vertical break in slope at the uphill end (head) of a gully. Headcuts migrate uphill and elongate the gully.

Headwater swale – The swale or dip in the natural topography that is upslope from a stream, at its headwaters. There may or may not be any evidence of overland or surface flow of water in the headwater swale.

Hillslope – Sediment erosion site associated with areas above the riparian area.

Horizontal drains – Drains installed in cut slopes and beneath fills to remove subsurface water and guard against slides in problem areas. Typically, they consist of perforated metal or plastic pipes in drill holes that have been bored horizontally into the aquifer or water-bearing formation.

Hydrological connectivity – Degree to which water from a source site or unstable area is conveyed to the network of the natural watercourse of concern.

Hydrologically connected road - Any road segment that, during a design runoff event, has a continuous surface flowpath between any part of the road prism and a natural stream channel..

Hydro-seeding (hydraulic seeding) – An erosion control technique for applying a slurry of seed, fertilizer and mulch by hydraulically spraying the mixture on the ground surface. Hydro-seeding is typically performed on slopes that are too steep for dry seeding.

Impaired- The term used by the EPA and Regional Water Quality Control Boards to designate streams with water quality impacts such as high temperatures, levels of sediment, or other chemical pollutants. If a stream is officially listed as *impaired* under the CWA 303(d) listing, it triggers a requirement for TMDL (Total Maximum Daily Load) non-point source pollution limits to be set for that stream.

Inactive road – A road needed only infrequently, for fire control or other intermittent management activities. These roads remain largely unused for most of the year, or for several years in succession, but have drainage structures intact and require regular inspection and maintenance.

Inboard ditch – The drainage ditch on the inside of the road, usually at the foot of a cutbank.

Infiltration – The movement of water through the soil surface of the soil.

Inner gorge – A stream reach bounded by steep valley walls that terminate upslope into a more gently topography. Common in areas of rapid stream downcutting or uplift.

Insloped road – Road surface that is sloped in toward the cutbank. Insloped roads usually have an inboard ditch that collects runoff from the road surface and cutbank.

Intermittent stream – Any nonpermanent flowing drainage feature having a definable channel and evidence of scour and deposition. Intermittent streams flow in response to rainfall, and then for some period after the cessation of rainfall (being fed by groundwater discharge).

Landslide – The downslope movement of a mass of earth caused by gravity. Includes but is not limited to debris slides, torrents, rock falls, debris avalanches, and creep. It does not include dry ravel or surface erosion by running water. It may be caused by natural erosional processes, by natural disturbances (e.g., earthquakes or fire events) or human disturbances (e.g., mining or road construction).

LWD – Large woody debris; portions of downed trees that collect in the stream and provide channel structure and habitat for aquatic animals.

Maintained road – A road which is regularly inspected and whose cutslopes, road surface, drainage structures and fillslopes are maintained to prevent erosion and deterioration.

Maintenance activities – Routine maintenance activities that may require clearing, grading, or excavation to maintain original line and grade, hydraulic capacity, or original purpose of the facility.

Maintenance facilities – Facilities under County ownership or control that contain such areas as fueling areas, waste storage or disposal facilities, wash racks, equipment or vehicle storage, and materials storage areas.

Mass wasting – Downslope movement of soil mass under force of gravity; often used synonymously with “landslide”.

Mature tree - A tree with width greater than a 12-inch (30cm) diameter at breast height (dbh).

Mitigate – To offset or lessen real or potential negative environmental impacts or effects through the application of additional controls or actions.

Mulch – Material placed or spread on the surface of the ground to protect it from raindrop, rill and gully erosion. Mulches include wood chips, rock, straw, wood fiber, and a variety of other natural and synthetic materials.

Nonpoint source discharge – Discharge from a diffuse pollution source, that is one without a single point of origin or not introduced into a receiving stream from a specific outlet like a pipe.

Oil waste – Oil of any kind or in any form, including but not limited to petroleum, fuel oil, sludge, oil refuse, and oil mixed with wastes other than dredged soil.

Ordinary High Water Mark – “That line on the shore established by the fluctuations of water and indicated by physical characteristics such as a clear, natural line impressed on the bank, shelving, changes in the character of the soil, destruction of terrestrial vegetation, the presence of litter and debris, or other appropriate means that consider the characteristics of the surrounding area.” [33 CFR 328.3(e)]

Organic matter – Material that is derived from living organisms, such as plants.

Outboard fill – The outside road edge fill material, usually generated by side cast road construction. This fill often comprises up to half the running surface width.

Outboard berm – A mounded earthen curb along the outboard edge of the road usually generated by periodic grading of the road. Berms trap water on the road.

Outfall – The discharge from a CMP, quantified by the vertical distance from the CMP outlet to its catchment basin.

Out-migration – The life cycle phase of anadromous salmonid fish, where juveniles move downstream from fresh water to the estuary and then the ocean for their salt water phase.

Outsloped road – Road surface that is sloped out away from the cutbank toward the road’s fillslope. Outsloped roads may or may not have an inboard ditch.

Outsloping – The act of converting an insloped road to an outsloped road. Outsloping can also refer to the act of excavating the fill along the outside of the road and placing and grading it against the cutbank, thereby creating an outsloped surface where the roadbed once existed.

Partial bench – A partial bench road is one in which the road bed is part bench and part fill, somewhere between full bench and a full fill road.

Peak flow (flood flow) – The highest amount of stream or river flow occurring in a year or from a single storm event.

Perched outlet – A condition in which a culvert’s outlet is suspended over the immediate downstream pool, requiring fish to leap into a culvert (DFG).

Perennial stream – A stream that typically has running water on a year-round basis.

Permanent road – A road which is planned and constructed to be part of a permanent all-season transportation system. These roads have a surface which is suitable of use throughout the entire winter period and have drainage structures, if any, at watercourse crossings which will accommodate the 50-year flood flow. Permanent roads receive regular and storm-period inspection and maintenance.

Permeable fill – See *Drainage blanket*.

Photopoint – Established point on the landscape used to conduct photographic monitoring.

Put-to-bed - The process of actively abandoning a road by eliminating all conceivable risks of sediment production until the road is again needed in future years. “Putting-to- bed” or road closure involves completely removing stream crossing fills and associated drainage structures and eliminating the risk of sediment production from roads. (See *Road closure*.)

Range finder – A hand-held field instrument used to measure distances less than about 1000 feet.

Ratio (slope) – A way of expressing slope gradient as a ration of horizontal distance to vertical rise, such as 3:1 (3 feet horizontal for every 1 foot vertical rise of fall).

Ravel (dry ravel) – Soil particles dislodging and rolling down a slope under the influence of gravity. Ravel occurs most rapidly when a cohesionless soil on a steep slope dries out. Ravelling is dramatically increased when frost acts on the exposed soil. Ravel on some steep, bare cutbanks can quickly fill ditches and supply sediment that is then eroded and moved to nearby ditch relief culverts or streams by concentrated ditch flow.

Rearing – The phase of a life cycle for a salmonid fish, where juveniles emerge from eggs and grow to large enough size to become adults or migrate to the ocean (for anadromous forms).

Redd – The nest depression, constructed by spawning salmonid fish in stream gravels, in which the eggs are laid.

Rill – A small erosion channel formed by concentrated surface runoff that is less than one square foot in cross sectional area. It typically forms where rainfall and surface runoff is concentrated on fillslopes, cutbanks, and ditches. Larger channels are called gullies.

Rip-rap – The large rock or other suitable material placed on the ground or along streambanks as an armoring device to prevent or reduce erosion.

Riparian – The banks and other lands adjacent to lakes, watercourse, estuaries, and wet areas. Often refers to water-loving vegetation along the water’s edge.

Riparian zone –Area alongside a stream that provides shade for water temperatures, streambed and flow modification by contributing large woody debris, filtration of organic and inorganic material, upslope stability, bank and channel stabilization and vegetative structure diversity for fish and wildlife habitat. (Source: California Forest Practice Rules, California Department of Forestry and Fire Protection Resource Management-Forest Practice Program, 2003.

River run rock – Aggregate (gravel) that is excavated from a river bed. It is usually well rounded and, unless screened, also contains sand.

Road abandonment – In the past, road abandonment was synonymous with blocking the road and letting it grow over with vegetation. Today, proper road abandonment involves a series of proactive steps and activities that essentially erosion-proof a road so that further maintenance will not be needed and significant erosion will not occur. (See also: *Road closure*)

Road closure – Also called “proactive road abandonment”, it is a method of closing a road so that regular maintenance is no longer needed and future erosion is largely prevented. The goal of road closure is to leave the road so that little or no maintenance is required for stability while the road is unused. Road closure usually involves erosion-proofing techniques including removing stream crossing fills, removing unstable road and landing fills, installing cross road drains for permanent road surface drainage and other erosion prevention and erosion control measures as needed. Proper road closure is not accomplished by blocking a road and walking away from it to let “nature reclaim the road”. (See also: *Road abandonment*)

Road failure – Damage to the roadbed (usually caused by a road bed slump, fill failure, stream crossing washout or major gully) which prevents vehicular passage, but does not usually mean minor cutbank or fill sloughing incidental to road settling.

Road fill excavation – Excavation and removal of unstable or potentially unstable fill and/or sidecast spoil from the outer edge of a road prism. Road fill excavations are performed as a preventive measure to guard against landsliding of unstable material into downslope stream channels.

Road grade – The slope of a road along its alignment.

Road maintenance – The actions taken to prevent erosion and/or the deterioration of a road, including the cutbank, the road surface, the fillslope and all drainage structures. Road maintenance activities include such tasks as grading, ditch cleaning, brushing and culvert cleaning.

Road network – The pattern of all the roads in an ownership, watershed, hillside or other defined area. The road network typically includes main trunk roads, secondary roads, and spur roads (in logging areas).

Road reconstruction – Repair or upgrading of those pre-existing roads that are to be restored or improved to make them useable for traffic. Reconstruction typically refers to road rebuilding when one or more road failures have occurred. (See: *Road failure*)

Road runoff – Surface runoff that collects on and is drained from the road surface, usually as a direct response to rainfall.

Rock armor – Coarse rock that is placed to protect a soil surface, usually from erosion caused by flowing or falling water. Rock armor is one type of material used for energy dissipation at culvert outfalls.

Rock pit – A large outcrop of bedrock that has been developed for aggregate uses, such as road surfacing material and/or larger rock armor. A borrow pit is an excavation from which material is removed for use in another location. (See also: *Borrow site*)

Rolling dip – Shallow, rounded dip in the road where road grade reverses for a short distance and surface runoff is directed in the dip or trough to the outside or inside of the road. Rolling dips are drainage facilities constructed to remain effective while allowing passage of motor vehicles at reduced road speed.

Runoff – Rainfall or snowmelt which flows overland across the surface or hillslopes and along roads and trails.

Rust line – The upper limit of rust inside a CMP which reflects the depth of sustained high water flows through the pipe.

Salmon, Chinook – A salmonid species, also called King Salmon in California.

Salmon, Coho – A salmonid fish species, also called Silver Salmon in California.

Salmonid – A species of fish that is a member of the salmon and trout family.

Sanitary sewer system – Underground pipes that carry off only domestic and industrial waste, not storm water.

Sediment – Organic or inorganic material that is carried or suspended in water and that settles out to form deposits in the storm drain system or receiving waters.

Sediment delivery – Material (usually referring to sediment) which is delivered to a stream channel. Sediment delivery often refers to the percent of material eroded from a site which actually gets delivered to a stream channel (as opposed to that which is stored on the hillslope).

Sheet erosion – The loss of thin layers of soil across a large surface area.

Shotgun culvert – A CMP that protrudes from the road fill with no down spout. The falling water often causes substantial erosion in the catchment area.

Sidecast – The excess earthen material pushed or dumped over the side of roads. Sidecasting usually refers to pushing loose dirt off the road down an embankment (as opposed to leaving loose dirt piled along the shoulder or roadside ditch after activities such as blading. This practice (in this manual) refers to relatively small quantities of soil created through activities such as blading the surface or road shoulders, not large quantities of soil from landslides or other mass wasting events.

Silt fence – A constructed barrier used to contain soil eroded from a construction site. The barrier is made from filter fabric stretched between fence posts placed on contour along a slope.

Slope ratio – See *Ratio*

Slope stability - The resistance of a natural or artificial slope or other inclined surface to failure by landsliding (mass movement).

Slump – An episodic, fast to very slow mass movement process involving the rotation of a block of hillslope or road along a broadly concave slip surface, often referred to as a rotational slide.

Smolt – A juvenile salmonid fish in the later phase of transitioning from fresh water to salt water, before migrating to the ocean.

Spawning – The phase of adult salmonid fish where redds (nests) are made and eggs are laid in gravels of streams.

Species of Special Concern – A designation used by California (CSC) and federal (FSC) agencies to refer to those species of animals (and sometimes plants) that have declining population levels, limited ranges, and/or continuing threats that have made them vulnerable to extinction. They may soon reach the point where they meet criteria for listing as threatened or endangered under the State and/or Federal Endangered Species Acts. No special legal protections are associated with this designation alone.

Spoil disposal site – The location where spoil material (woody debris and excavated soils) can be placed without the threat of accelerated erosion or of initiating slope instability. Stable spoil disposal sites include the cut portion of closed roads, the inside portion of turnouts, and flat or low gradient natural benches.

Spoil (spoil materials) – Material (soil and organic debris) that is not used or needed as a functional part of the road or a landing. Spoil material is generated during road construction, reconstruction, and maintenance activities.

Spur road – A side road off a main trunk road or a secondary road. Most spur roads are dead-end.

Steelhead – The anadromous form of the rainbow trout. Aside from their sea-going habits and large size at spawning, there is little to distinguish them from rainbow trout that are resident in the same streams that steelhead use for spawning.

Storm maintenance (emergency road maintenance) – Road inspection and maintenance that is performed during periods of high rainfall and runoff when drainage structures are most likely to plug, malfunction or fail.

Storm water – Rainfall runoff, snow melt runoff, surface runoff and drainage.

Storm water drainage system – Streets, gutters, conduits, artificial drains, channels and watercourses, or other facilities that are owned, operated, maintained, and used for the purpose of collecting, storing, transporting, or disposing of storm water.

Stream – A natural configuration in the land surface that transports water in a perennial, intermittent, or ephemeral circumstance.

Stream Class – A category of a watercourse based on the its *beneficial* use (based on California Board of Forestry regulations, 2000):

Class I Watercourse: A stream (or lake) that is used for a domestic water supply (including springs) on the site and/or within 100 feet downstream of the operations area; and/or fish always or seasonally present onsite, including habitat to sustain fish migration and spawning. (It typically flows year round, but may flow seasonally.)

Class II Watercourse: A stream (or lake) that has fish always or seasonally present offsite within 1000 feet downstream, and/or aquatic habitat for nonfish aquatic species; excludes Class III waters that are tributary to Class I waters. (These streams may flow year round or seasonally; many springs and wetlands are also included.)

Class III Watercourse: A stream channel (or lake) with no aquatic life present but showing evidence of being capable of sediment transport to Class I or II waters under normal high water flow conditions.

Class IV Watercourse: Man-made watercourses, usually downstream, for established domestic, agricultural, hydroelectric supply or other beneficial use.

Stream crossing – The location where a road crosses a stream channel. Drainage structures used in stream crossings include bridges, fords, culverts and a variety of temporary crossings.

Stream crossing excavation – The excavation of the fill material that was used to build (fill) a stream crossing, specifically a culverted crossing, a log crossing, or a temporary crossing. A stable stream crossing excavation must be dug down to the level of the original stream bed, with side slopes graded (excavated) back to a stable angle (usually 50% or less, depending on soil characteristics).

Subdrainage (subsurface drainage) – The flow of water beneath the surface of the ground. Along roads, specific construction techniques can be used to make sure subsurface drainage is not impeded by the road bed or road fill.

Surface erosion – The detachment and transport of soil particles by wind, water or gravity. Surface erosion can occur as the loss of soil in a uniform layer (sheet erosion), in many rills, gullies, or by dry ravel.

Surface runoff – Precipitation, snow-melt, or irrigation water in excess of what can infiltrate the soil surface and be stored in small surface depressions; a major transporter of non-point source pollutants.

Surfacing (surface course) – The top layer of the road surface, also called the wear course. Rock aggregate and paving are two types of surfacing used to weather-proof the road for winter use.

Swale – A channel-like linear depression or low spot on a hillslope which rarely carries runoff except during extreme rainfall events. Some swales may no longer carry surface runoff under the present climatic conditions.

Take - To harass, harm, pursue, hunt, shoot, wound, kill, trap, capture, or collect, or to attempt to engage in any such conduct (as defined by the federal Endangered Species Act); to hunt, pursue, catch, capture, or kill, or to attempt to do any of these things (as defined by the California Endangered Species Act).

Threatened Species – Any species which is likely to become an endangered species within the foreseeable future throughout all or a significant portion of its range; an official designation under the California and/or Federal Endangered Species Acts.

Through-cut (Double cut) – A road section that has a cutbank on each side of the road, both higher than the road elevation. This condition channels water down the road and usually creates an erosion source until a drainage opportunity occurs at a single cutbank section.

Through-fill – A road which is entirely composed of fill material and which has a berm along both sides of the road, thereby intentionally containing road surface runoff on the road and directing it to a single discharge point, usually a fabricated metal berm-drain. Through-fills are typically found at sensitive stream crossings where the fill is bermed on both sides of the road.

Total Maximum Daily Load (TMDL) – A process under the federal Clean Water Act that provides a tool for implementing State water quality standards and is based on the relationship between pollution sources and instream water quality conditions.

Trash rack – A debris grid built just over or upstream from a culvert inlet to trap floating woody debris before it plugs the culvert inlet.

Turbidity – Water that is cloudy or muddy usually due to sediment.

Unstable areas – Areas characterized by mass movement features or unstable soils, or by some or all of the following: hummocky topography consisting of rolling bumpy ground, frequent benches, and depressions; short irregular surface drainages which begin and end on the slope; visible tension cracks and head wall scarps; irregular slopes which may be slightly concave in upper half and convex in lower half as a result of previous slope failure; evidence of impaired ground water movement resulting in local zones of saturation including sag ponds with standing water, springs, or patches of wet ground; hydrophytic (wet site) vegetation; leaning, jackstrawed or split trees; pistol-butted trees with excessive sweep in areas of hummocky topography.

Unstable soils – These soils are indicated by the following characteristics: 1) unconsolidated, non-cohesive soils (coarser textured than loam) and colluvial debris including sands and gravels, rock fragments, or weathered granitics (e.g., decomposed granite or “DG”). Such soils are usually associated with a risk of shallow-seated landslides on slopes of 65% or more, having non-cohesive soils less than 5 feet deep in an area where precipitation exceeds 4 inches in 24 hours in a 5-year recurrence interval; 2) increase and decrease in volume as moisture content changes. During dry weather, these materials become hard and rock-like exhibiting a network of polygonal shrinkage cracks and a blocky structure resulting from desiccation. Some cracks may be greater than 5 feet in depth. When wet, these materials are very sticky, dingy, shiny and easily molded.

Washed out stream crossing – A stream crossing fill that has been partially or completely eroded and “washed” downstream. Washouts usually occur when a culvert plugs and streamflow backs up and flows over the roadbed during flood events.

Waters of the U.S. – In nontidal waters, this federal legal jurisdiction extends: a) to the ordinary high water mark in the absence of adjacent wetlands; b) beyond the ordinary high water mark to the limit of the adjacent wetlands when present; c) to the limit of the wetland when only wetlands exist.

Waters of the State – Any surface water or groundwater, including saline waters, within the boundaries of the state (§13050(e) of the Porter-Cologne Water Quality Control Act).

Watercourse – Surface water bodies including streams, lakes, bays, estuaries, lagoons, reservoirs, and ponds. The term includes any well defined channel with distinguishable bed and bank showing evidence of having contained flowing water indicated by deposit of rock, sand or gravel.

Water quality – The chemical and biological characteristics of stream and lake water.

Watershed – The area or drainage basin contributing water, organic matter, dissolved nutrients and sediments to a stream or lake.

Wetlands – Areas that are inundated by surface water or ground water with a frequency sufficient to support, and under normal circumstances do or would support, a prevalence of vegetative or aquatic life that require saturated or seasonally saturated soil conditions for growth and reproduction (Executive Order 11990). Wetlands generally include, but are not limited to, marshes, bogs and similar areas.

Winterize – To perform erosion prevention and erosion control work on a road in preparation for winter rains and flood flows.

Sources: Weaver & Hagans (1994); Caltrans (1998); Downie et al. (1998); Lewis et al. (2000); ODOT (1999); various state and federal statutes and regulations.

Appendix C

Technical References

1. **Culvert Criteria for Fish Passage:** California Salmonid Stream Habitat Restoration Manual; Appendix IX-A. (California Department of Fish and Game; Flosi et al, 2002)
<http://www.dfg.ca.gov/fish/Resources/HabitatManual.asp>
2. **Guidelines for Salmonid Passage at Stream Crossings - NOAA Fisheries;** California Salmonid Stream Habitat Restoration Manual; Appendix IX-B. (California Department of Fish and Game; Flosi et al, 2002)
<http://www.dfg.ca.gov/fish/Resources/HabitatManual.asp>
3. **NOAA Fisheries Water Drafting Specifications:** Southwest Region, August 2001
<http://www.swr.nmfs.noaa.gov/hcd/WaterDrafting-02.htm>
4. **CDFG Guidelines for Temporary Water Drafting:** California Department of Fish and Game Timber and Resources Program; DRAFT 2001
5. **Dust Palliative Application Guidelines:** San Francisco Regional Water Quality Control Board; Erosion and Sediment Control Manual 2002.

**CALIFORNIA SALMONID STREAM
HABITAT RESTORATION MANUAL**
FISH PASSAGE EVALUATION IX-A-1 April 2003

APPENDIX IX-A
STATE OF CALIFORNIA RESOURCES AGENCY
DEPARTMENT OF FISH AND GAME

CULVERT CRITERIA FOR FISH PASSAGE

“For habitat protection, ecological connectivity should be a goal of stream-road crossing designs. The narrowest scope of crossing design is to pass floods. The next level is requiring fish passage. The next level includes sizing the crossing for sediment and debris passage. For ecosystem health, "ecological connectivity" is necessary. Ecological connectivity includes fish, sediment, debris, other organisms and channel/floodplain processes.”

Ken Bates – WDFW

INTRODUCTION

The following criteria have been adopted by the California Department of Fish and Game (DFG) to provide for upstream fish passage at culverts. This is not a culvert design manual, rather it is supplemental criteria to be used by qualified professionals for the design of culverts that meet both hydraulic and fish passage objectives while minimizing impacts to the adjacent aquatic and riparian resources. The objective of these criteria is to provide unimpaired fish passage with a goal of providing ecological connectivity.

Previous versions of the DFG Culvert Criteria were based on hydraulic design of culverts to match the swimming performance of adult anadromous salmonids. This revision of the criteria has been expanded to include considerations for juvenile anadromous salmonids, nonanadromous salmonids, native non-salmonids, and non-native fish. While criteria are still included for the hydraulic design option, criteria have been added for two additional design options that are based on the principles of ecological connectivity. The two additional design methods are:

- Active Channel Option
- Stream Simulation Option

The criteria contained in this document are based on the works of several organizations including state and federal agencies, universities, private organizations and consulting professionals. These criteria are intended to be consistent with the National Oceanic and Atmospheric Administration Fisheries, Southwest Region (NOAA-SWR) *Guidelines for Salmonid Passage at Stream Crossings*, as well as being in general agreement with Oregon and Washington Departments of Fish and Wildlife culvert criteria for fish passage. This document is considered a “Work in Progress” and will be revised as new information warrants.

The Caltrans Highway Design Manual defines a culvert as “A closed conduit which allows water to pass under a highway,” and in general, has a single span of less than 6.1 meters (20 feet) or multiple spans totaling less than 6.1 meters. For the purpose of fish passage, the distinction between bridge, culvert or low water crossing is not as important as the effect the structure has on the form and function of the stream. To this end, these criteria conceptually apply to bridges and low water crossings, as well as culverts.

The primary factors that determine the extent to which fish passage will be impacted by the construction of a crossing are:

- The degree of constriction the crossing has on the stream channel
- The degree to which the streambed is allowed to adjust to vertically
- The length of stream channel impacted by the crossing
- The degree to which the stream velocity has been increased by the crossing.

For unimpaired fish passage, it is desirable to have a crossing that is a large percentage of the channel bankfull width, allows for a natural variation in bed elevation, and provides bed and bank roughness similar to the upstream and downstream channel. In general, bridges are preferred over culverts because they typically do not constrict a stream channel to as great a degree as culverts and usually allow for vertical movement of the streambed. Bottomless culverts may provide a good alternative for fish passage where foundation conditions allow their construction and width criteria can be met. In all cases, the vertical and lateral stability of the stream channel should be taken into consideration when designing a crossing.

APPLICATION OF CRITERIA

These criteria are intended to apply to new and replacement culverts where fish passage is legally mandated or is otherwise important to the life histories of the fish and wildlife that utilize the stream and riparian corridor. Not all stream crossings may be required to provide upstream fish passage, and of those that do, some may only require passage for specific species and age classes of fish.

Where existing culverts are being modified or retrofitted to improve fish passage, the Hydraulic Design Option criteria should be the design objective for the improvements. However, it is acknowledged that the conditions that cause an existing culvert to impair fish passage may also limit the remedies for fish passage improvement. Therefore, short of culvert replacement, the Hydraulic Design Option criteria should be the goal for improvement and not the required design threshold.

To determine the biological considerations and applicable criteria for a particular culvert site, the project sponsors should contact the Department of Fish and Game, the National Oceanic and Atmospheric Administration Fisheries (for projects in marine and anadromous waters) and the US Fish and Wildlife Service (for projects in anadromous and fresh waters) for guidance.

It is the responsibility of the project sponsor to obtain the most current version of the culvert criteria for fish passage. Copies of the current criteria are available from the Department of Fish and Game through the appropriate Regional office, which should be the first point of contact for

any stream crossing project. Addresses and phone numbers for the California Department of Fish and Game Regional Offices are shown in Table IX A-1.

Table IX-A- 1. California Department of Fish and Game regional offices

Region	Address	Phone Number
Northern California – North Coast Region	601 Locust Street Redding, CA 96001	(530) 225-2300
Sacramento Valley – Central Sierra Region	1701 Nimbus Drive, Rancho Cordova, CA 95670	(916) 358-2900
Central Coast Region	7329 Silverado Trail, P.O. Box 47, . Yountville, CA 94599	(707) 944-5500
San Joaquin Valley – Southern Sierra Region	1234 E. Shaw Avenue Fresno, CA 93710	(559) 243-4005 x151
South Coast Region	4649 Viewridge Avenue San Diego, CA 92123	(858) 467-4200
Eastern Sierra - Inland Deserts Region	4775 Bird Farm Road Chino Hills, CA 9709	(909) 597-9823

DESIGN OPTIONS

All culverts should be designed to meet appropriate hydraulic capacity and structural integrity criteria. In addition, where fish passage is required, the culvert shall be designed to meet the criteria of the Active Channel Design Option, Stream Simulation Design Option or the Hydraulic Design Option for Upstream Fish Passage. The suitability of each design option is shown in Table IX-A-2.

Table IX-A- 2. Suitability design options.

Allowable Design Options			
Fish Passage Requirement	Active Channel Design Option or Stream Simulation Design Option	Hydraulic Design Option For Upstream Fish Passage	Hydraulic Capacity & Structural Integrity
Adult Anadromous Salmonids	X	X	
Adult Non-Anadromous Salmonids	X	X	
Juvenile Salmonids	X	X	
Native Non-Salmonids	X	Conditional based on species swimming data	
Non-Native Species	X		
Fish Passage Not Required	X		X

Active Channel Design Option

The Active Channel Design Option (Figure IX-A-1) is a simplified design method that is intended to size a crossing sufficiently large and embedded deep enough into the channel to allow the natural movement of bedload and formation of a stable bed inside the culvert. Determination of the high and low fish passage design flows, water velocity, and water depth is

not required for this option since the stream hydraulic characteristics within the culvert are intended to mimic the stream conditions upstream and downstream of the crossing.

The Active Channel Design Option is suitable for the following conditions:

- New and replacement culvert installations
- Simple installations with channel slopes less than 3 percent
- Short culvert length (less than 100 feet)
- Passage required for all fish.

Culvert Setting & Dimensions

Culvert Width - The minimum culvert width shall be equal to, or greater than, 1.5 times the active channel width.

Culvert Slope - The culvert shall be placed level (0 percent slope).

Embedment - The bottom of the culvert shall be buried into the streambed not less than 20 percent of the culvert height at the outlet and not more than 40 percent of the culvert height at the inlet.

Embedment does not apply to bottomless culverts.

See section on Considerations, Conditions, and Restrictions for all design options.

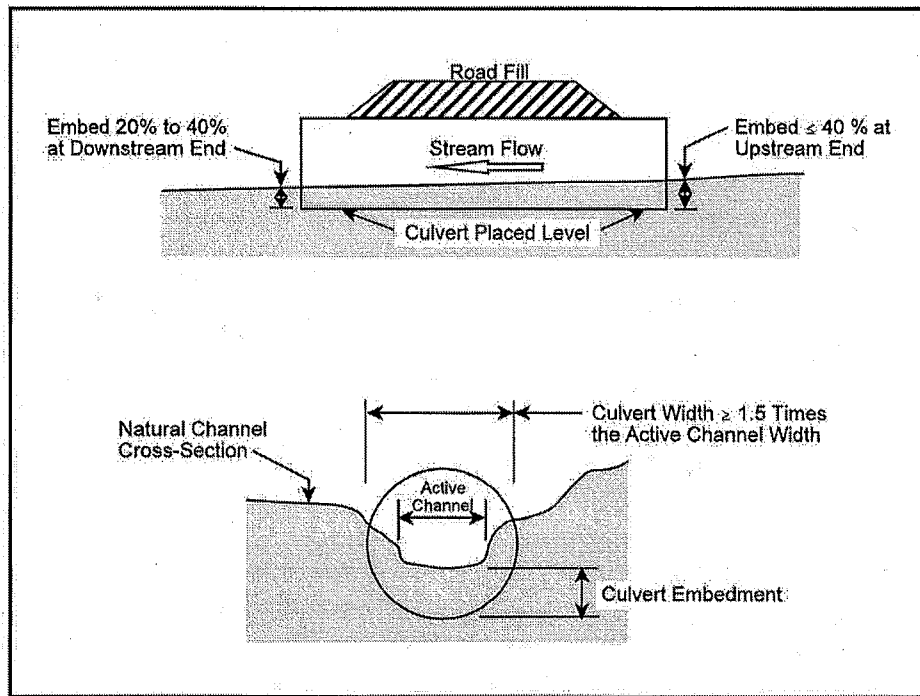

Figure IX-A-1. Active channel design option.

Stream Simulation Design Option

The Stream Simulation Design Option (Figure IX-A-2) is a design process that is intended to mimic the natural stream processes within a culvert. Fish passage, sediment transport, flood and

debris conveyance within the crossing are intended to function as they would in a natural channel. Determination of the high and low fish passage design flows, water velocity, and water depth is not required for this options since the stream hydraulic characteristics within the culvert are designed to mimic the stream conditions upstream and downstream of the crossing.

Stream simulation crossings are sized as wide, or wider than, the bankfull channel and the bed inside the culvert is sloped at a gradient similar to that of the adjacent stream reach. These crossings are filled with a streambed mixture that is resistant to erosion and is unlikely to change grade, unless specifically designed to do so. Stream simulation crossings require a greater level of information on hydrology and topography and a higher level of engineering expertise than the Active Channel Design Option.

The Stream Simulation Design Option is suitable for the following conditions:

- New and replacement culvert installations
- Complex installations with channel slopes less than 6 percent
- Moderate to long culvert length (greater than 100 feet)
- Passage required for all fish
- Ecological connectivity required.

Culvert Setting & Dimensions

Culvert Width - The minimum culvert width shall be equal to, or greater than, the bankfull channel width. The minimum culvert width shall not be less than 6 feet.

Culvert Slope - The culvert slope shall approximate the slope of the stream through the reach in which it is being placed. The maximum slope shall not exceed 6 percent.

Embedment - The bottom of the culvert shall be buried into the streambed not less than 30 percent and not more than 50 percent of the culvert height. Embedment does not apply to bottomless culverts.

Substrate Configuration and Stability

- Culverts with slopes greater than 3 percent shall have the bed inside the culvert arranged into a series of step-pools with the drop at each step not exceeding the limits shown in Table IX-A-7.
- Smooth walled culverts with slopes greater than 3 percent may require bed retention sills within the culvert to maintain the bed stability under elevated flows.
- The gradation of the native streambed material or engineered fill within the culvert shall address stability at high flows and shall be well graded to minimize interstitial flow through it.

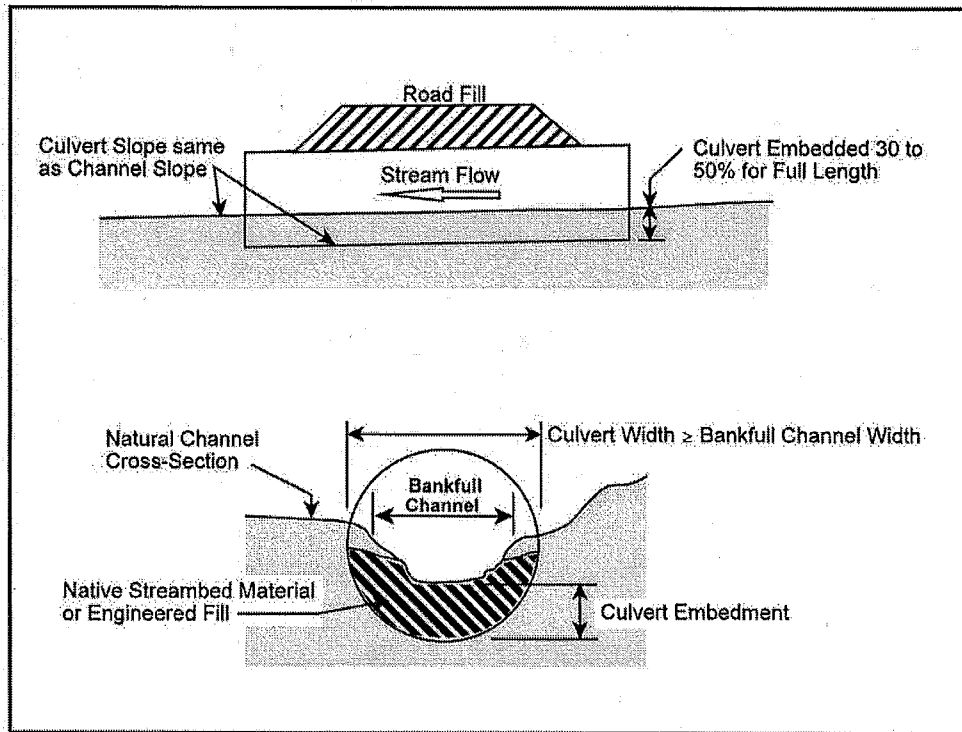

Figure IX-A- 2 Stream simulation design option.

Hydraulic Design Option

The Hydraulic Design Option is a design process that matches the hydraulic performance of a culvert with the swimming abilities of a target species and age class of fish. This method targets distinct species of fish, therefore it does not account for ecosystem requirements of non-target species. There can be significant errors associated with estimation of hydrology and fish swimming speeds that are mitigated by making conservative assumptions in the design process. Determination of the high and low fish passage design flows, water velocity, and water depth are required for this option.

The Hydraulic Design Option requires hydrologic data analysis, open channel flow, hydraulic calculations, and information on the swimming ability and behavior of the target group of fish. This design option can be applied to the design of new and replacement culverts and can be used to evaluate the effectiveness of retrofits for existing culverts.

The Hydraulic Design Option is suitable for the following conditions:

- New, replacement, and retrofit culvert installations
- Low to moderate channel slopes (less than 3 percent)
- Active Channel Design or Stream Simulation Options is not physically feasible
- Swimming ability and behavior of target species of fish is known
- Ecological connectivity not required
- Evaluation of proposed improvements to existing culverts.

High Design Flow for Fish Passage

The high design flow for fish passage is used to determine the maximum water velocity within the culvert. Where flow duration data is available or can be synthesized, use the values for Percent Annual Exceedance Flow shown in Table IX-A-3. If flow duration data is not available the values shown for Percentage of 2-year Recurrence Interval Flow may be used as an alternative.

Table IX-A- 3. High design flow for fish passage.

High Design Flow for Fish Passage		
Species/Life Stage	Percent Annual Exceedance Flow	Percentage of 2-year Recurrence Interval Flow
Adult Anadromous Salmonids	1%	50%
Adult Non-Anadromous Salmonids	5%	30%
Juvenile Salmonids	10%	10%
Native Non-Salmonids	5%	30%
Non-Native Species	10%	10%

Low Design Flow for Fish Passage

The low design flow for fish passage is used to determine the minimum depth of water within a culvert. Where flow duration data is available or can be synthesized, use the values for Percent Annual Exceedance Flow shown in Table IX-A-4. If the Percent Annual Exceedance Flow is determined to be less than the Alternate Minimum Flow, use the Alternate Minimum Flow. If flow duration data is not available, the values shown for Alternate Minimum Flow may be used.

Table IX-A- 4. Low design flow for fish passage.

Low Design Flow for Fish Passage		
Species/Lifestage	Percent Annual Exceedance Flow	Alternate Minimum Flow (cfs)
Adult Anadromous Salmonids	50%	3
Adult Non-Anadromous Salmonids	90%	2
Juvenile Salmonids	95%	1
Native Non-Salmonids	90%	1
Non-Native Species	90%	1

Hydraulics

Maximum Average Water Velocity in Culvert (At high design flow) - Where fish passage is required, the maximum average water velocity within the culvert shall not exceed the values shown in Tables IX-A-5 and IX-A-6.

Minimum Water Depth in Culvert (At low design flow) - Where fish passage is required, the minimum water depth within the culvert shall not be less than the values shown in Table IX-A-5.

Table IX-A- 5. Maximum average water velocity and minimum depth of flow.

Species/Lifestage	Maximum Average Water Velocity(fps)	Minimum Flow Depth(ft)
Adult Anadromous Salmonids	See Table 6	1.0
Adult Non-Anadromous Salmonids	See Table 6	0.67
Juvenile Salmonids	1	0.5
Native Non-Salmonids	Species specific swimming performance data is required for the use of the hydraulic design option for non-salmonids. Hydraulic design is not allowed for these species without this data.	
Non-Native Species		

Table IX-A- 6. Culvert length vs. maximum average water velocity for adult salmonids.

Culvert Length (ft)	Adult Non-Anadromous Salmonids (fps)	Adult Anadromous Salmonids (fps)
<60	4	6
60-100	4	5
100-200	3	4
200-300	2	3
>300	2	2

Maximum Outlet Drop - Hydraulic drops between the water surface in the culvert to the pool below the culvert should be avoided for all cases. Where fish passage is required and a hydraulic drop is unavoidable, its magnitude should be evaluated for both high design flow and low design flow and shall not exceed the values shown in Table IX-A-7. If a hydraulic drop occurs at the culvert outlet, a jump pool of at least 2 feet in depth shall be provided.

Table IX-A- 7. Maximum drop at culvert outlet.

Species/Lifestage	Maximum Drop (ft)
Adult Anadromous Salmonids	1
Adult Non-Anadromous Salmonids	1
Juvenile Salmonids	0.5
Native Non-Salmonids	Where fish passage is required for native non-salmonids, no hydraulic drop shall be allowed at the culvert outlet unless data is presented which will establish the leaping ability and leaping behavior of the target species of fish.
Non-Native Species	

Hydraulic Controls - Hydraulic controls in the channel upstream and/or downstream of a crossing can be used to provide a continuous low flow path through the crossing and stream reach. They can be used to facilitate fish passage by establishing the following desirable conditions:

- Control depth and water velocity within the crossing
- Concentrate low flows
- Provide resting pools upstream and downstream of the crossing
- Control erosion of the streambed and banks.

Baffles - Baffles shall not be used in the design of new or replacement culverts in order to meet the hydraulic design criteria.

Adverse Hydraulic Conditions - The following hydraulic conditions are generally considered to be detrimental to efficient fish passage and should be avoided. The degree to which they impede fish passage depends upon the magnitude of the condition. Crossings designed by the Hydraulic Design Option should be evaluated for the following conditions at high design flow for fish passage:

- Super critical flow
- Hydraulic jumps
- Highly turbulence conditions
- Abrupt changes in water surface elevation at inlet and outlet.

Culvert Setting & Dimensions

Culvert Width - The minimum culvert width shall be 3 feet.

Culvert Slope - The culvert slope shall not exceed the slope of the stream through the reach in which the crossing is being placed. If embedment of the culvert is not possible, the maximum slope shall not exceed 0.5 percent.

Embedment - Where physically possible, the bottom of the culvert shall be buried into the streambed a minimum of 20 percent of the height of the culvert below the elevation of the tailwater control point downstream of the culvert. The minimum embedment should be at least 1 foot. Where physical conditions preclude embedment, the hydraulic drop at the outlet of a culvert shall not exceed the limits specified above.

CONSIDERATIONS, CONDITIONS, AND RESTRICTIONS FOR ALL DESIGN OPTIONS

Anadromous Salmonid Spawning Areas

The hydraulic design method shall not be used for new or replacement culverts in anadromous salmonid spawning areas.

High Design Flow for Structural Integrity

All culvert stream crossings, regardless of the design option used, shall be designed to withstand the 100-year peak flood flow without structural damage to the crossing. The analysis of the structural integrity of the crossing shall take into consideration the debris loading likely to be encountered during flooding.

Headwater Depth

The upstream water surface elevation shall not exceed the top of the culvert inlet for the 10-year peak flood and shall not be greater than 50 percent of the culvert height or diameter above the top of the culvert inlet for the 100-year peak flood.

Oversizing for Debris

In some cases, it may be necessary to increase the size of a culvert beyond that calculated for flood flows or fish passage in order to pass flood-borne debris. Where there is significant risk of inlet plugging by flood borne debris, culverts should be designed to pass the 100-year peak flood without exceeding the top of the culvert inlet. Oversizing for flood-borne debris may not be necessary if a culvert maintenance agreement has been effected and the culvert inlet can be safely accessed for debris removal under flood flow conditions.

Inlet Transitions

A smooth hydraulic transition should be made between the upstream channel and the culvert inlet to facilitate passage of flood borne debris.

Interior Illumination

Natural or artificial supplemental lighting shall be provided in new and replacement culverts that are over 150 feet in length. Where supplemental lighting is required, the spacing between light sources shall not exceed 75 feet.

Adverse Conditions to be Avoided:

- Excessive skew with stream alignment
- Changes in alignment within culvert
- Trash racks and livestock fences
- Realignment of the natural stream channel.

Multiple Culverts

Multiple culverts are discouraged where the design criteria can be met with a single culvert. If multiple culverts are necessary, a multi-barreled box culvert is preferred over multiple individual culverts. Site-specific criteria may apply to multiple culvert installations.

Bottomless Culverts

Bottomless culverts are generally considered to be a good solution where fish passage is required, so long as culvert width criteria are met and the culvert footings are deep enough to avoid scour exposure. Site-specific criteria may apply to bottomless culverts installations.

CULVERT RETROFITS FOR FISH PASSAGE

Culverts that have fish passage problems were generally designed with out regard for fish passage. While these culverts may convey stream flow, they are often undersized for the watershed hydrology, stream fluvial processes, have been placed at a slope that is too steep for fish passage, or have had the outlet raised above the channel bed in order to control the water velocity in the culvert. Most of these problems arise from the culvert being undersized. For undersized culverts it is difficult, if not impossible, to meet the objective of unimpaired fish passage without replacing the culvert. However, in many cases, fish passage can be significantly improved for some species and their life stages without fully meeting the hydraulic criteria for new culverts. In some cases a modest improvement in hydraulic conditions can result in a significant improvement in fish passage.

Where existing culverts are being modified or retrofitted to improve fish passage, the Hydraulic Design Option criteria should be the design objective for improvements. However, it is acknowledged that the conditions that cause an existing culvert to impair fish passage may also limit the remedies for fish passage improvement. Therefore, short of culvert replacement, the Hydraulic Design Option criteria should be the goal for improvement and not the required design threshold.

A protocol for fish passage evaluation at existing culverts is included in the Department of Fish and Game's *California Salmonid Stream Habitat Restoration Manual*. This manual also includes information methods for improving fish passage at road crossings.

Fish passage through existing non-embedded culverts may be improved through the use of gradient control weirs upstream or downstream of the culvert, interior baffles or weirs, or in some cases, fish ladders. However, these measures are not a substitute for good fish passage design for new or replacement culverts.

Gradient Control Weirs

- Downstream Channel - Control weirs can be used in downstream channel to backwater through culvert or reduce an excessive hydraulic drop at a culvert outlet. The maximum drop at the culvert outlet shall not exceed the values in Table IX-A-7.
- Upstream Channel - Control weirs can be used in the channel upstream of the culvert inlet to re-grade the bed slope and improve exit conditions.
- Hydraulic Drop - The individual hydraulic drop across a single control weir shall not exceed the values in Table IX-A-7, except that boulder weirs may drop 1 foot per weir for all salmonids, including juveniles.

Baffles

Baffles may provide incremental fish passage improvement in culverts with excess hydraulic capacity that cannot be made passable by other means. Baffles may increase clogging and debris accumulation within the culvert and require special design considerations specific to the baffle type.

Fishways

Fishways are generally not recommended, but may be useful for some situations where excessive drops occur at the culvert outlet. Fishways require specialized site-specific design for each installation.

SELECT REFERENCES AND INTERNET WEB SITES

Baker, C.O. and F.E. Votapka. 1990. *Fish Passage Through Culverts*. Federal Highways Administration & USDA Forest Service. FHWA-FL-90-006. (Available from USDA Forest Service publications, San Dimas Laboratory, CA)

Behlke, C.E., D.L. Kane, R.F. McLean, and M.D. Travis. 1991. *Fundamentals of Culvert Design for Passage of Weak-Swimming Fish, Final Report*. Alaska DOT&PF and USDT, Federal Highway

Administration, FHWA-AK-RD-90-10.
California Department of Fish and Game: www.dfg.ca.gov

California Department of Fish and Game. 1998. *California Salmonid Stream Habitat Restoration Manual, 3rd Edition*. Habitat Conservation Division.

National Oceanic and Atmospheric Administration Fisheries, Southwest Region. *Stream Crossing Guidelines* <http://swr.nmfs.noaa.gov/habitat.htm>

FishXing software and learning systems for the analysis of fish passage through culverts. USDA. Forest Service. 1999. *Fish Xing. Version 2.2*. Six Rivers National Forest Watershed Interactions Team, Eureka, CA. www.stream.fs.fed.us/fishxing/

USDA Forest Service Water-Road Interaction Technology Series Documents
www.streamfs.fed.us/waterroad/indexhtml

Washington Department of Fish and Wildlife Fish Passage Technical Assistance
www.wa.gov/wdfw/hab/engineer/habeng.htm

Washington Department of Fish and Wildlife, 1999. *Fish Passage Design at Road Culverts*.
www.wa.gov/wdfw/hab/engineer/cm/toc.htm

**CALIFORNIA SALMONID STREAM
HABITAT RESTORATION MANUAL**
FISH PASSAGE EVALUATION IX-B-1 April 2003

APPENDIX IX-B

National Oceanic and Atmospheric Administration Fisheries
Southwest Region

GUIDELINES FOR SALMONID PASSAGE AT STREAM CROSSINGS

INTRODUCTION

This document provides guidelines for design of stream crossings to aid upstream and downstream passage of migrating salmonids. It is intended to facilitate the design of a new generation of stream crossings, and assist the recovery of threatened and endangered salmon species. These guidelines are offered by the National Oceanic and Atmospheric Administration Fisheries, Southwest Region (NOAA-SWR), as a result of its responsibility to prescribe fishways under the Endangered Species Act, the Magnuson-Stevens Act, the Federal Power Act, and the Fish and Wildlife Coordination Act. The guidelines apply to all public and private roads, trails, and railroads within the range of anadromous salmonids in California.

Stream crossing design specifications are based on the previous works of other resource agencies along the US West Coast. They embody the best information on this subject at the time of distribution. Meanwhile, there is mounting evidence that impassable road crossings are taking a more significant toll on endangered and threatened fish than previously thought. New studies are revealing evidence of the pervasive nature of the problem, as well as potential solutions. Therefore, this document is appropriate for use until revised, based on additional scientific information, as it becomes available.

The guidelines are general in nature. There may be cases where site constraints or unusual circumstances dictate a modification or waiver of one or more of these design elements. Conversely, where there is an opportunity to protect salmonids, additional site-specific criteria may be appropriate. Variances will be considered by the NOAA on a project-by-project basis. When variances from the technical guidelines are proposed, the applicant must state the specific nature of the proposed variance, along with sufficient biological and/or hydrologic rationale to support appropriate alternatives. Understanding the spatial significance of a stream crossing in relation to salmonid habitat within a watershed will be an important consideration in variance decisions.

Protocols for fish-barrier assessment and site prioritization are under development by the California Department of Fish and Game (DFG). These will be available in updated versions of the *California Salmonid Stream Habitat Restoration Manual*. Most streams in California also support important populations of non-salmonid fishes, amphibians, reptiles, macroinvertebrates, insects, and other organisms important to the aquatic food web. Some of these may also be

threatened or endangered species and require "ecological connectivity" that dictate other design criteria not covered in this document. Therefore, the project applicant should check with the local Fish and Game office, the US Fish and Wildlife Service (USFWS), and/or tribal biologists to ensure other species are fully considered.

The California Department of Transportation Highway Design Manual defines a culvert as "A closed conduit which allows water to pass under a highway," and in general, has a single span of less than 20 feet or multiple spans totaling less than 20 feet. For the purpose of fish passage, the distinction between bridge, culvert or low water crossing is not as important as the effect the structure has on the form and function of the stream. To this end, these criteria conceptually apply to bridges and low water crossings, as well as culverts.

PREFERRED ALTERNATIVES AND CROSSINGS

The following alternatives and structure types should be considered in order of preference:

- Nothing - Road realignment to avoid crossing the stream
- Bridge - spanning the stream to allow for long term dynamic channel stability
- Streambed simulation strategies - bottomless arch, embedded culvert design, or ford
- Non-embedded culvert - this is often referred to as a hydraulic design, associated with more traditional culvert design approaches limited to low slopes for fish passage
- Baffled culvert, or structure designed with a fishway - for steeper slopes.

If a segment of stream channel where a crossing is proposed is in an active salmonid spawning area then only full span bridges or streambed simulations are acceptable.

DESIGNING NEW AND REPLACEMENT CULVERTS

The guidelines below are adapted from culvert design criteria published by many federal and state organizations including the California Department of Fish and Game (DFG 2002). It is intended to apply to new and replacement culverts where fish passage is legally mandated or important.

Active Channel Design Method

The Active Channel Design method is a simplified design that is intended to size a culvert sufficiently large and embedded deep enough into the channel to allow the natural movement of bedload and formation of a stable bed inside the culvert. Determination of the high and low fish passage design flows, water velocity, and water depth is not required for this method since the stream hydraulic characteristics within the culvert are intended to mimic the stream conditions upstream and downstream of the crossing. This design method is usually not suitable for stream channels that are greater than 3 percent in natural slope or for culvert lengths greater than 100 feet. Structures for this design method are typically round, oval, or squashed pipes made of metal or reinforced concrete.

- Culvert Width - The minimum culvert width shall be equal to, or greater than,
- 1.5 times the active channel width.
- Culvert Slope - The culvert shall be placed level (0 percent slope).

- Embedment - The bottom of the culvert shall be buried into the streambed not less than 20 percent of the culvert height at the outlet and not more than 40 percent of the culvert height at the inlet.

Stream Simulation Design Method

The Stream Simulation Design method is a design process that is intended to mimic the natural stream processes within a culvert. Fish passage, sediment transport, flood and debris conveyance within the culvert are intended to function as they would in a natural channel. Determination of the high and low fish passage design flows, water velocity, and water depth is not required for this option since the stream hydraulic characteristics within the culvert are designed to mimic the stream conditions upstream and downstream of the crossing. The structures for this design method are typically open bottomed arches or boxes but could have buried floors in some cases. These culverts contain a streambed mixture that is similar to the adjacent stream channel. Stream simulation culverts require a greater level of information on hydrology and geomorphology (topography of the stream channel) and a higher level of engineering expertise than the Active Channel Design method.

- Culvert Width - The minimum culvert width shall be equal to, or greater than, the bankfull channel width. The minimum culvert width shall not be less than 6 feet.
- Culvert Slope - The culvert slope shall approximate the slope of the stream through the reach in which it is being placed. The maximum slope shall not exceed 6 percent.
- Embedment - The bottom of the culvert shall be buried into the streambed not less than 30 percent and not more than 50 percent of the culvert height. For bottomless culverts the footings or foundation should be designed for the largest anticipated scour depth.

Hydraulic Design Method

The Hydraulic Design method is a design process that matches the hydraulic performance of a culvert with the swimming abilities of a target species and age class of fish. This method targets distinct species of fish and therefore does not account for ecosystem requirements of non-target species. There are significant errors associated with estimation of hydrology and fish swimming speeds that are resolved by making conservative assumptions in the design process. Determination of the high and low fish passage design flows, water velocity, and water depth are required for this option.

The Hydraulic Design method requires hydrologic data analysis, open channel flow hydraulic calculations and information on the swimming ability and behavior of the target group of fish. This design method can be applied to the design of new and replacement culverts and can be used to evaluate the effectiveness of retrofits of existing culverts.

- Culvert Width - The minimum culvert width shall be 3 feet.
- Culvert Slope - The culvert slope shall not exceed the slope of the stream through the reach in which it is being placed. If embedment of the culvert is not possible, the maximum slope shall not exceed 0.5 percent.
- Embedment - Where physically possible, the bottom of the culvert shall be buried into the streambed a minimum of 20 percent of the height of the culvert below the elevation of the tailwater control point downstream of the culvert. The minimum embedment should

be at least 1 foot. Where physical conditions preclude embedment, the hydraulic drop at the outlet of a culvert shall not exceed the limits specified above.

Hydrology for Fish Passage under the Hydraulic Design Method

High Flow Design For Fish Passage - The high flow design for adult fish passage is used to determine the maximum water velocity within the culvert. Where flow duration data is available or can be synthesized the high fish passage design flow for adult salmonids should be the 1 percent annual exceedance. If flow duration data or methods necessary to compute them are not available then 50 percent of the 2 year flood recurrence interval flow may be used as an alternative. Another alternative is to use the discharge occupied by the cross-sectional area of the active stream channel. This requires detailed cross-section information for the stream reach and hydraulic modeling. For upstream juvenile salmonid passage the high design flow should be the 10 percent annual exceedance flow.

Low Flow Design For Fish Passage - The low flow design for fish passage is used to determine the minimum depth of water within a culvert. Where flow duration data is available or can be synthesized the 50 percent annual exceedance flow or 3 cfs, whichever is greater, should be used for adults and the 95 percent annual exceedance flow or 1 cfs, whichever is greater, should be used for juveniles.

Maximum Average Water Velocities in the Culvert at the High Fish Passage Design Flow

Average velocity refers to the calculated average of velocity within the barrel of the culvert. Juveniles require 1 fps or less for upstream passage for any length culvert at their High Fish Passage Design Flow. For adult salmonids use the following table to determine the maximum velocity allowed.

Table IX-B- 1. Water velocity for culvert length.

Culvert Length (ft)	Velocity (fps) - Adult Salmonids
<60	6
60-100	5
100-200	4
200-300	3
>300	2

Minimum Water Depth at the Low Fish Passage Design Flow

For non-embedded culverts, minimum water depth shall be twelve inches for adult steelhead trout and salmon, and six inches for juvenile salmon.

Juvenile Upstream Passage

Hydraulic design for juvenile upstream passage should be based on representative flows in which juveniles typically migrate. Recent research (NOAA 2001, in progress) indicates that providing for juvenile salmon up to the 10 percent annual exceedance flow will cover the majority of flows in which juveniles have been observed moving upstream. The maximum average water velocity at this flow should not exceed 1 fps. In some cases, over short distances, 2 fps may be allowed.

Maximum Hydraulic Drop

Hydraulic drops between the water surface in the culvert and the water surface in the adjacent channel should be avoided for all cases. This includes the culvert inlet and outlet. Where a hydraulic drop is unavoidable, its magnitude should be evaluated for both high design flow and low design flow and shall not exceed 1 foot for adults or 6 inches for juveniles. If a hydraulic drop occurs at the culvert outlet, a jump pool of at least 2 feet in depth should be provided.

Structural Design and Flood Capacity

All culvert stream crossings, regardless of the design option used, shall be designed to withstand the 100-year peak flood flow without structural damage to the crossing. The analysis of the structural integrity of the crossing shall take into consideration the debris loading likely to be encountered during flooding. Stream crossings or culverts located in areas where there is significant risk of inlet plugging by flood borne debris should be designed to pass the 100-year peak flood without exceeding the top of the culvert inlet (Headwater-to-Diameter Ratio less than one). This is to ensure a low risk of channel degradation, stream diversion, and failure over the life span of the crossing. Hydraulic capacity must be compensated for expected deposition in the culvert bottom.

Other Hydraulic Considerations

Besides the upper and lower flow limit, other hydraulic effects need to be considered, particularly when installing a culvert:

- Water surface elevations in the stream reach must exhibit gradual flow transitions, both upstream and downstream.
- Abrupt changes in water surface and velocities must be avoided, with no hydraulic jumps, turbulence, or drawdown at the entrance.
- A continuous low flow channel must be maintained throughout the entire stream reach.

In addition, especially in retrofits, hydraulic controls may be necessary to provide resting pools, concentrate low flows, prevent erosion of streambed or banks, and allow passage of bedload material.

Culverts and other structures should be aligned with the stream, with no abrupt changes in flow direction upstream or downstream of the crossing. This can often be accommodated by changes in road alignment or slight elongation of the culvert. Where elongation would be excessive, this must be weighed against better crossing alignment and/or modified transition sections upstream and downstream of the crossing. In crossings that are unusually long compared to streambed width, natural sinuosity of the stream will be lost and sediment transport problems may occur even if the slopes remain constant. Such problems should be anticipated and mitigated in the project design.

RETROFITTING CULVERTS

For future planning and budgeting at the state and local government levels, redesign and replacement of substandard stream crossings will contribute substantially to the recovery of salmon stocks throughout the state. Unfortunately, current practices do little to address the

problem: road crossing corrections are usually made by some modest level of incremental, low cost "improvement" rather than re-design and replacement. These usually involve bank or structure stabilization work, but frequently fail to address fish passage. Furthermore, bank stabilization using hard point techniques frequently denigrates the habitat quality and natural features of a stream. Nevertheless, many existing stream crossings can be made better for fish passage by cost-effective means. The extent of the needed fish passage improvement work depends on the severity of fisheries impacts, the remaining life of the structure, and the status of salmonid stocks in a particular stream or watershed.

For work at any stream crossing, site constraints need to be taken into consideration when selecting options. Some typical site constraints are ease of structure maintenance, construction windows, site access, equipment, and material needs and availability. The decision to replace or improve a crossing should fully consider actions that will result in the greatest net benefit for fish passage. If a particular stream crossing causes substantial fish passage problems which hinder the conservation and recovery of salmon in a watershed, complete redesign and replacement is warranted. *Consolidation and/or decommissioning of roads can sometimes be the most cost effective option.* Consultations with NOAA or DFG biologists can help in selecting priorities and alternatives.

Where existing culverts are being modified or retrofitted to improve fish passage, the Hydraulic Design method criteria should be the design objective for the improvements. However, it is acknowledged that the conditions that cause an existing culvert to impair fish passage may also limit the remedies for fish passage improvement. Therefore, short of culvert replacement, the Hydraulic Design method criteria should be the goal for improvement but not necessarily the required design threshold.

Fish passage through existing non-embedded culverts may be improved through the use of gradient control weirs upstream or downstream of the culvert, interior baffles or weirs, or in some cases, fish ladders. However, these measures are not a substitute for good fish passage design for new or replacement culverts. The following guidelines should be used:

- Hydraulic Controls - Hydraulic controls in the channel upstream and/or downstream of a culvert can be used to provide a continuous low flow path through culvert and stream reach. They can be used to facilitate fish passage by establishing the following desirable conditions: Control depth and water velocity within culvert, concentrate low flows, provide resting pools upstream and downstream of culvert and prevent erosion of bed and banks. A change in water surface elevation of up to one foot is acceptable for adult passage conditions, provided water depth and velocity in the culvert meet other hydraulic guidelines. A jump pool must be provided that is *at least* 1.5 times the jump height, or a minimum of two feet deep, whichever is deeper.
- Baffles - Baffles may provide incremental fish passage improvement in culverts with excess hydraulic capacity that cannot be made passable by other means. Baffles may increase clogging and debris accumulation within the culvert and require special design considerations specific to the baffle type. Culverts that are too long or too high in

gradient require resting pools, or other forms of velocity refuge spaced at increments along the culvert length.

- Fishways - Fishways are generally not recommended, but may be useful for some situations where excessive drops occur at the culvert outlet. Fishways require specialized site-specific design for each installation. A NOAA or DFG fish passage specialist should be consulted.
- Multiple Culverts - Retrofitting multiple barrel culverts with baffles in one of the barrels may be sufficient as long as low flow channel continuity is maintained and the culvert is reachable by fish at low stream flow.

OTHER GENERAL RECOMMENDATIONS

Trash racks and livestock fences should not be used near the culvert inlet. Accumulated debris may lead to severely restricted fish passage, and potential injuries to fish. Where fencing cannot be avoided, it should be removed during adult salmon upstream migration periods. Otherwise, a minimum of 9 inches clear spacing should be provided between pickets, up to the high flow water surface. Timely clearing of debris is also important, even if flow is getting around the fencing. Cattle fences that rise with increasing flow are highly recommended.

Natural or artificial supplemental lighting should be provided in new and replacement culverts that are over 150 feet in length. Where supplemental lighting is required, the spacing between lightsources shall not exceed 75 feet.

The NOAA and the DFG set instream work windows in each watershed. Work in the active stream channel should be avoided during the times of year salmonids are present. Temporary crossings, placed in salmonid streams for water diversion during construction activities, should meet all of the guidelines in this document. However, if it can be shown that the location of a temporary crossing in the stream network is not a fish passage concern at the time of the project, then the construction activity only needs to minimize erosion, sediment delivery, and impact to surrounding riparian vegetation.

Culverts shall only be installed in a de-watered site, with a sediment control and flow routing plan acceptable to NOAA or DFG. The work area shall be fully restored upon completion of construction with a mix of native, locally adapted, riparian vegetation. Use of species that grow extensive root networks quickly should be emphasized. Sterile, non-native hybrids may be used for erosion control in the short term if planted in conjunction with native species.

Construction disturbance to the area should be minimized and the activity should not adversely impact fish migration or spawning. If salmon are likely to be present, fish clearing or salvage operations should be conducted by qualified personnel prior to construction. If these fish are listed as threatened or endangered under the federal or state Endangered Species Act, consult directly with NOAA and DFG biologists to gain authorization for these activities. Care should be taken to ensure fish are not chased up under banks or logs that will be removed or dislocated by construction. Return any stranded fish to a suitable location in a nearby live stream by a method that does not require handling of the fish.

If pumps are used to temporarily divert a stream to facilitate construction, an acceptable fish screen must be used to prevent entrainment or impingement of small fish. Contact NOAA or DFG hydraulic engineering staff for appropriate fish screen specifications. Unacceptable wastewater associated with project activities shall be disposed of off-site in a location that will not drain directly into any stream channel.

POST-CONSTRUCTION EVALUATION AND LONG TERM MAINTENANCE AND ASSESSMENT

Post-construction evaluation is important to assure the intended results are accomplished, and that mistakes are not repeated elsewhere. There are three parts to this evaluation:

- Verify the culvert is installed in accordance with proper design and construction procedures
- Measure hydraulic conditions to assure that the stream meets these guidelines
- Perform biological assessment to confirm the hydraulic conditions are resulting in successful passage.

NOAA and/or DFG technical staff may assist in developing an evaluation plan to fit site-specific conditions and species. The goal is to generate feedback about which techniques are working well, and which require modification in the future. These evaluations are not intended to cause extensive retrofits of any given project unless the as-built installation does not reasonably conform to the design guidelines, or an obvious fish passage problem continues to exist. Over time, the NOAA anticipates that the second and third elements of these evaluations will be abbreviated as clear trends in the data emerge.

Any physical structure will continue to serve its intended use only if it is properly maintained. During the storm season, timely inspection and removal of debris is necessary for culverts to continue to move water, fish, sediment, and debris. In addition, all culverts should be inspected at least once annually to assure proper functioning. Summary reports should be completed annually for each crossing evaluated. An annual report should be compiled for all stream crossings and submitted to the resource agencies. A less frequent reporting schedule may be agreed upon for proven stream crossings. Any stream crossing failures or deficiencies discovered should be reported in the annual cycle and corrected promptly.

REFERENCES

- Baker, C.O. and F.E. Votapka. 1990. *Fish Passage Through Culverts*. Federal Highways Administration & USDA Forest Service. FHWA-FL-90-006. 67 pages. (Available from USDA Forest Service publications, San Dimas Laboratory, CA)
- Bates, K. 1992. *Fishway Design Guidelines for Pacific Salmon*. Working paper 1.6. (Available from Ken Bates, Lands and Restoration Program Chief Engineer, Washington Dept. of Fish and Wildlife. 600 Capitol Way North, Olympia, WA, 98501-1091.)

- Beechie, T., E. Beamer, and L. Wasserman. 1994. Estimating Coho Salmon Rearing Habitat and Smolt Production Losses in a Large River Basin, and Implications for Habitat Restoration. *North Am. J. Fish. Mgt.* 14:797 - 811.
- Behlke, C.E., D.L. Kane, R.F. McLean, and M.D. Travis. 1991. *Fundamentals of Culvert Design for Passage of Weak-Swimming Fish, Final Report*. Alaska DOT&PF and USDT, Federal Highway Administration, FHWA-AK-RD-90-10. 177 pages.
- California Department of Fish and Game. 1998. California Salmonid Stream Habitat Restoration Manual, 3rd Edition, Part IX Fish Passage Evaluation At Road Crossings. California Department of Fish and Game. 2001. *Culvert Criteria for Fish Passage*.
- Clay, C.H. 1995. *Design of Fishways and Other Fish Facilities, 2nd Edition*. Lewis Publishers, CRC Press (imprint), Boca Raton, FL. 248 pages.
- Evans, W.A. and B. Johnston. 1980. *Fish Migration and Fish Passage: a Practical Guide to Solving Fish Passage Problems*. US Forest Service, EM - 7100 - 2, Washington, D.C.
- Furniss, M.J., T.D. Roelofs, and C.S. Yee. 1991. *Road Construction and Maintenance*. American Fisheries Society Special Publication 19:297-323.
- Gebhards, S., and J. Fisher. 1972. *Fish Passage and Culvert Installations*. Idaho Fish and Game Rep. 12 pages.
- Groot, C., and L. Margolis, editors. 1991. *Pacific Salmon Life Histories*. Univ. British Columbia Press, Vancouver. 564 pages.
- Hassler, T.J. 1987. Species Profiles: Life Histories and Environmental Requirements of Coastal Fishes and Invertebrates (Pacific Southwest) Coho Salmon. US Fish Wildl. Serv. Biol. Rep. 82(11.70). US Army Corps of Engineers, TR EL-82-4. 19 pages.
- Johnson, A. and J.F. Orsborn. Undated, circa 1990. *Welcome to Culvert College*. Washington Trout, Duvall, WA. 67 pages.
- Kay, AR., and R.B. Lewis. 1970. *Passage of Anadromous Fish Through Highway Drainage Structures*. California Division of Highways, Dist. 01 Res. Rep. 629110. 28 pages.
- Katopodis, C. 1992. *Introduction to Fishway Design*. Working Document from Fish Passageways and Diversion Structures Course presented by National Education and Training Center, USFWS.
- Lauman, J.E. 1976. *Salmonid Passage at Stream-Road Crossings*. Oregon Dept. of Fish and Wildlife. McClellan, T.J. 1970. *Fish Passage Through Highway Culverts*. US Dept. Trans., Federal Highway Administration and Oregon State Game Comm., Portland OR. 16 pages.
- Meehan, W.R., editor. 1991. *Influences of Forest and Rangeland Management on Salmonid Fishes and Their Habitats*. American Fisheries Society Special Publication 19. ODFW, 1997. Oregon Department of Fish and Wildlife *Guidelines and Criteria for Stream-Road Crossings*. 7 pages.
- Pearsons, T.N., G.A. McMichael, S.W. Martin, E.L. Bartrand, A. Long, and S.A. Leider. 1996. *Yakima*

Species Interactions Studies Annual Report 1994. US Department of Energy, Bonneville Power Administration Annual Report 1994. No. DOE/BPB99852-3.

Poulin, V.A., and H.W. Argent. 1997. *Stream Crossing Guidebook for Fish Streams, a Working Draft*. Prepared for British Columbia Ministry of Forests. 80 pages.

Sandercock, F.K. 1991. *Life History of Coho Salmon*. Pages 397-445 in C. Groot and L. Margolis (ed.s.), *Pacific salmon life histories*. Univ. British Columbia Press, Vancouver. 564 pages.

Shirvell, C.S. 1994. Effect of changes in streamflow on the microhabitat use and movement of sympatric juvenile coho salmon (*Oncorhynchus kisutch*) and chinook salmon (*O. tshawytscha*) in a natural stream. *Can. J. Fish. Aquat. Sci.* 51:1644-1652.

Salmonid Restoration Federation Conference. 1996. *Culvert Fish Passage Design and Retrofitting Workshop*. Fortuna, CA. 30 pages.

USD.A., Forest Service, 1999. *Water Road Interaction Series*.

US Fish and Wildlife Service. 1983-19___. *Species Profiles: Life Histories and Environmental Requirements of Coastal Fishes and Invertebrates*. US Fish Wildlife Service, Biol. Rep. 82(11). US Army Corps of Engineers, TR EL-82-4.

Waples, R.S. 1991. *Definition of "Species @ under the ESA: Application to Pacific Salmon*. US Dep. Commer., NOAA Tech. Memo., NMFS, F/NWC-194, 29 pages.

Washington State Department of Fish and Wildlife, 1999. *Design Guidelines for Fish Passage Design at Road Culverts*.

Washington State Department of Transportation. 1998. *Juvenile and Resident Salmonid Movement and Passage Through Culverts. Final Report. Rept. No. WA-RD 457.1*. (Available through the National Technical Information Service, Springfield, VA 22616).

Washington State Department of Transportation. 1997. *Fish Passage Program Department of Transportation Inventory Final Report*. G. Johnson (Project Leader) and nine others. 58 pages.

Washington State Department of Transportation. 1996. *Investigation of Culvert Hydraulics Related to Juvenile Fish Passage. Final Report. Rept. No. WA-RD 388.1*. (Available through the National Technical Information Service, Springfield, VA 22616)

Weaver, W.E., and D.K. Hagans. 1994. *Handbook for Forest and Ranch Roads*. Mendocino County Resource Conservation District. 161 pages.

Wietkamp, L.A., T.C. Wainwright, G.J. Bryant, G.B. Milner, D.J. Teel, R.G. Kope, and R.S. Waples. 1995. *Status Review of Coho Salmon from Washington, Oregon, and California*. US Dep. Commer., NOAA Tech. Memo., NMFS-NWFSC-24, Northwest Fisheries Science Center, Seattle, Washington. 258 pages.

Ziemer, G.L. 1961. *Fish Transport in Waterways*. Alaska Dept. of Fish and Game. 2 pages.

INTERNET RESOURCES

California Department of Fish and Game

<http://www.dfg.ca.gov>

National Oceanic and Atmospheric Administration Fisheries Southwest Region

<http://swr.nmfs.noaa.gov>

Washington Department of Fish and Wildlife Fish Passage Technical Assistance

<http://www.wa.gov/wdfw/hab/engineer/habeng.htm>

Oregon Road/Stream Crossing Restoration Guide, Spring 1999 (with ODFW criteria)

<http://www.nwr.noaa.gov/1salmon/salmesa/4ddocs/orfishps.htm>

FishXing software and learning systems for the analysis of fish migration through culverts

<http://www.stream.fs.fed.us/fishIXing/>

USDA Forest Service Water-Road Interaction Technology Series Documents

<http://www.stream.fs.fed.us/water-road/indeIX.html>

British Columbia Forest Practices Code Stream Crossing Guidebook for Fish Streams

<http://www.for.gov.bc.ca/tasb/legsregs/fpc/fpcguide/stream/str-toc.htm>

Please direct questions regarding this material to:

National Oceanic and Atmospheric Administration Fisheries Phone: (707) 575-6050

Hydraulic Engineering Staff Fax: (707) 578-3425

777 Sonoma Avenue, Suite 325

Santa Rosa, CA 95404

Email: nmfs.swr.fishpassage@noaa.gov

WATER DRAFTING SPECIFICATIONS

National Marine Fish Service

Southwest Region

August 2001

"Water-drafting" is a short-duration, small-pump operation that withdraws water from streams or impoundments to fill conventional tank trucks or trailers. Usually, this water is used to control road dust, or for wildfire management.(1) Short term water drafting is also used to temporarily de-water a construction site, or to temporarily divert water around a construction site.

The specifications below are given primarily for the protection of juvenile anadromous salmonids, in waters where they are known to exist; but they also may be applied to protect a host of other aquatic organisms as well. The issue of sufficient in-stream flow for life support of the aquatic ecosystem should be addressed by a local Fish & Game biologist. Temporal and cumulative effects should be considered on a watershed scale. While we give some guidelines in that area, the actual impact of water drafting on stream ecology should be assessed and monitored at the local level by qualified personnel.

The main focus of this guidance is the construction, operation, and maintenance of a fish screen module(s) that must be installed at the in-stream end of the drafting hose to protect small salmon and steelhead fry from being entrained in the hose, or impinged on the surface of the screen. The specifications are based on the critical "approach velocity" at the screen surface(2), and a recognition that many temporary screens will not be outfitted with automatic cleaning devices to remove debris buildup. Since it is difficult to measure water velocities in the field, only the construction, pumping capacities, and operations are specified. Variances from these specifications may be considered on a case-by-case basis.

Operating Guidelines

1. Operations are restricted to one hour after sunrise to one hour before sunset.(3)
2. Pumping rate shall not exceed 350 gallons per minute.
3. The pumping rate shall not exceed ten percent of the stream flow.(4)
4. Seek streams and pools where water is deep and flowing, as opposed to streams with low flow and small isolated pools.
5. Pumping shall be terminated when the tank is full. The effect of single pumping operations, or multiple pumping operations at the same location, shall not result in obvious draw-down of either upstream or downstream pools.
6. Each pumping operation shall use a fish screen. The screen face should be oriented parallel to flow for best screening performance. The screen shall be designed and used such that it can be submerged with at least one-screen-height-clearance above and below the screen.
7. Operators shall keep a log on the truck containing the following information: *Operator's Name, Date, Time, Pump Rate, Filling Time, Screen Cleaned (Y or N), Screen Condition, Comments*. These guidelines should be included as instructions in a logbook with serially numbered pages. This assures each truck operator easy access to this information.

Screen Construction Criteria

1. Surface Area

The total (unobstructed) surface area of the screen shall be at least 2.5 square feet, based on the upper limit of pumping of 350 gpm(5). Larger surface areas are recommended where debris buildup is anticipated, and where stream depth is adequate to keep the screen submerged at approximately mid-depth.

2. Screen Mesh

Screen Mesh must be in good repair and present a sealed, positive barrier- effectively preventing entry of the "design fish" into the intake. The design fish in this case is a immature (20-30mm) salmon or steelhead fry.

The screen mesh size shall be: Round openings - maximum 3/32 inch diameter (.09 inch)

Square openings - maximum 3/32 inch diagonal (.09 inch)

Slotted openings - maximum 1/16 inch width (.07 inch)

3. Screen Design

Water drafting screens may be off-the-shelf products, but they are often custom-made devices appropriate to the scale and duration of pumping operation. To keep the screen supported and correctly positioned in the water column, adjustable support legs are advised. Screen geometry can be configured either as rectangular or cylindrical, i.e.- as a shallow "box-shape" or tubular. The intake structure shall be designed to promote uniform velocity distribution at all external mesh surfaces. This can be accomplished with a simple internal baffle device that distributes the flow evenly across the entire surface of the screen. In order to accomplish this, the designer needs to understand the hydraulic characteristics of these devices. There is a tendency for most of the intake water to enter the screen near the hose end, so a typical internal baffle would consist of a pipe (or a manifolded set of pipes) which have variable porosity holes at predetermined spacing. We recommend starting near the hose end with approximately 5-10% average open area, and gradually increasing the porosity toward the length of the screen. At a point where screen length exceeds three times the diameter of the suction hose, the baffling effect tends to diminish rapidly. At this point the baffle porosity may approach 100%. A successful baffle system will functionally distribute flow to all areas of the screen. A poorly designed screen may result in high-velocity "hot spots," which could lead to fish impingement on the screen face. Hydraulic testing of prototype screen designs is recommended where the application is on-going and extensive.

4. Screen Structure

The screen frame must be strong enough to withstand the hydraulic forces it will experience. However, structural frames, braces, and other elements that block the flow, change flow direction, or otherwise decrease the screen surface area should be minimized.

5. Screen Cleaning

The screen shall be cleaned as often as necessary to prevent approach velocity from exceeding 0.33 feet per second. Operators should withdraw the screen and clean it after each use, or as

necessary to keep screen face free of debris. Pumping should stop for screen cleaning when approximately fifteen percent or more of the screen area is occluded by debris. A suitable brush shall be on board the truck for this cleaning operation.

If the operator notes (a) impingement of any juvenile fish on the screen face or (b) entrainment of any fish through the screen mesh, he/she should stop operations and notify the Department of Fish & Game and/or NMFS hydraulic engineering staff:

National Marine Fisheries Service
Engineering Section
777 Sonoma Avenue, Suite 325
Santa Rosa, CA. 95404
(707) 575-6050

Rebecca Lent, Ph.D.
Regional Administrator

1. In case of emergency wildfire, where human life is in danger, the operator may disregard the screening requirement if a suitable screen is not immediately accessible.
2. Approach velocity is the horizontal velocity vector component, typically measured at a distance of 3 inches from the screen face.
3. Restricting operations to daylight-only prevents the use of lights that will attract fish to the drafting pool
4. Restricting drafting to ten percent of the stream flow provides adequate downstream flow to support fish, aquatic insects, amphibians, and other biota. Ten percent of flow may be estimated by pump operators.
5. If larger pumping volumes are needed, or if the pumping application is continuous, refer to <http://swr.nmfs.noaa.gov/habitat.htm> and review addendum for small pump intakes.

DRAFT

**Guidelines for Temporary Water Drafting from Watersheds
Supporting Anadromous Salmonids;
Special Application for Timber Harvest Activities
Preliminary Draft - Subject to Revision**



by Richard Macedo
STATE OF CALIFORNIA, Resources Agency, Department of Fish and Game

Timberland Resources Program
Central Coast Region
November 16, 2001

The purpose of this paper is to provide concise and updated criteria for protecting anadromous salmonids from impacts associated with water drafting. Criteria in this report are directed at anyone responsible for operating, permitting or overseeing small, temporary water diversion projects associated with timber harvest activities in coastal timberlands supporting salmon, steelhead or other important aquatic resources. Information in this report may not be applicable to water diversion projects in other locations. Criteria in this paper may change as a result of improved biological knowledge and/or changes associated with state or federal regulation.

Laws and policies governing the Department of Fish and Game (Department) in this matter include Section 1600 et seq. and Section 6100 of the Fish and Game Code, Section 703 of the Fish and Game Code (specifically the policies identified as "Salmon", "Steelhead Rainbow Trout", "Endangered and Threatened Species", "Water", and the "Joint Policy Statement on Coho Salmon" between the California State Board of Forestry and the California Fish and Game Commission). Fish and Game Code Section 1600 et seq. requires that the Department enter into an agreement with a person proposing to, among other actions, substantially divert or obstruct the natural flow of a river, stream, or lake. This includes water drafting. Applications can be obtained from a Department office.

Streams and rivers are used as water sources for timber harvest operations in coastal California. Water is used by itself or in combination with additives to minimize dust and improve running conditions on unpaved roads. Watering roads for dust abatement is often an enforceable condition for approved timber harvest plans. In addition to roads, water may be used in conjunction with controlled burns, wildfire suppression and watering for revegetation projects.

The typical water drafting system for a timber harvest operation involves a truck outfitted with a three to four thousand gallon storage tank, a truck-mounted centrifugal pump and an extendable intake hose. Pools are often targeted for diversion sites because they have sufficient volume to permit high diversion rates. Operators often pump at or near maximum rates to limit

down time, thereby maximizing the amount of road surface that can be watered in a given period. To prevent damage to the pump, operators avoid entraining rocks or air during pumping. Typically, an operator will back next to or pull alongside a pool, position a hose with the intake end near the bottom of a pool and commence pumping. Depending on the size and condition of the pump, an operator may fill a four thousand gallon water truck in 10 to 20 minutes. For most systems, the drafting rate can be adjusted.

The following three variables should be considered when designing a small, portable water drafting operation; 1) screen size, 2) approach velocity and 3) diversion rate. The following criteria for screen size, approach velocity and diversion rate are designed to protect fry-size salmonids from water diversion activities in California's timberlands. Use of these criteria may protect other species which occupy the same streams and lakes.

Screen Mesh Size:

Openings in perforated plate and woven wire screens shall not exceed 3/32 inches (2.38 millimeters). Slot opening in wedge wire screens shall not exceed 1.75 mm.

To prevent entrainment of fish during water diversion, the pump intake shall be fitted with screen made of woven mesh, perforated plate, wedge wire, or other durable fabric. The screen medium shall be able to withstand forces related to pumping and be of sufficient size to prevent small fish from entering the intake and being pumped along with diverted water.

Approach Velocity:

The velocity of water across the screen surface shall not exceed 0.33 feet/second at any point on the screen surface. To achieve this standard, the screen shall be kept clean and free of accumulated algae, leaves or other debris which could block portions of the screen surface and increase approach velocities at any point on the screen. The screen shall be supported above the bed of the streams so that no part of the screen surface is obstructed. Water truck operators shall move drafting hoses with attached screens in and out of the water after each drafting operation. The screen should be brushed clean and inspected each time it is placed into the water. This practice will usually prevent screens from accumulating significant amounts of debris and essentially replicate the function of a self-cleaning screen. Where a stationary pump is used, the screen should be checked frequently to ensure it is kept clean and free of debris. For screens where regular cleaning cannot be guaranteed, the approach velocity across the screen surface shall not exceed 0.0825 feet/second at any point on the screen.

Diversion Rate:

Water drafting may cause adverse impacts to juvenile salmonids if flow in source streams is reduced to insufficient levels. For these cases, a specific water drafting plan shall be developed. Concerns over impacts caused by reduced flows and the subsequent need for a water

drafting plan may not be necessary if the proposed water diversion conforms to all of the following standards:

- a. Flow in the source stream during water drafting will remain at 2.0 feet³/second or greater, and
- b. If diverting from a pool, reduction in pool volume will not exceed 10 percent, and
- c. Diversion rate will not exceed 10 percent of the surface flow from the source stream, and
- d. Instantaneous diversion rate is less than 350 gallons per minute (0.78 feet³/second)

For water diversion projects that will not meet criteria a through d above, a water drafting plan shall be prepared and approved by the Department through an Agreement pursuant to Section 1600 et seq. of the Fish and Game Code. This plan shall include the following:

1. Determine the instantaneous flow reduction and duration of reduction from the source stream.
2. Disclose potential impacts associated with both the instantaneous flow reduction and cumulative flow reduction and total volume removed from the source stream.
3. Identify proposed recommendations for minimizing adverse impacts such as a reduced hose diameter, decrease in pumping rates, use of alternative sites and/or restrict number of water withdraws from one location.
4. Require operators to maintain a water diversion log which records the date, time, pump rate, filling time, screen cleaning and inspection, and bypass flow from the source stream.
5. Conduct a pre-operations briefing with personnel who will be operating water drafting equipment and charged with compliance of the water diversion plan.

Additional Considerations:

While outside the scope of this report, standards for protecting anadromous salmonids may also be sufficient for protecting other species of fish, amphibians, reptiles and invertebrates. These considerations should be made on a case-by-case and species-by-species bases.

In certain situations and at specific sites, the requirement for screen and approach velocity criteria may be disregarded if an approved watering hole or sump is constructed adjacent to a stream or river. Large gravel bars adjacent to streams may be appropriate sites for constructing temporary water drafting holes. Unaltered sections of the gravel bar which lie between the watering hole and the flowing stream may provide the functional equivalent of a screen. In addition, approach velocities along the gravel bar must meet Department standards (e.g. < 0.33

feet/second for fry-size fish). Construction and use of these watering holes will be restricted to summer periods when storms and increasing stream flows are uncommon. Pursuant to Section 1600 et seq. of the Fish and Game Code, construction and use of watering holes will likely require a Lake and Streambed Alteration Agreement.

Example for Calculating Surface Area for Intake Screens:

The purpose of this example is to outline steps for calculating the appropriate screen surface area necessary to meet Department guidelines for approach velocities.

Scenario:

A water drafting operation will use a 4,000 gallon truck to divert water from a small stream which supports fry-size salmon and steelhead. At the maximum rate, the truck can be filled in 15 minutes. Calculate the surface area of screen necessary to comply with Department guidelines for approach velocities not to exceed 0.33 feet/second.

Step 1:

Calculate diversion rate in gallons per minute (gpm) with the pump running at full capacity.

$$\frac{4,000 \text{ gallons}}{15 \text{ minutes}} = 266.7 \text{ gpm}$$

Step 2:

Convert diversion rate from gpm to feet³/second (cfs). Note, to convert gpm to cfs, multiply the gpm figure by 0.00223.

$$266.7 \text{ gpm} \times 0.00223 = 0.59 \text{ cfs}$$

Step 3:

Using the maximum acceptable approach velocity of 0.33 feet/second, calculate how much surface area of screen is needed for a diversion rate of 0.59 cfs.

$$\frac{0.59 \text{ feet}^3/\text{second}}{0.33 \text{ feet/second}} = 1.79 \text{ feet}^2 \text{ (square feet)}$$

Answer: For this example, a screen surface area of 1.79 square feet or larger will satisfy the Department's standard for approach velocity.

Dust Palliative Application Guidelines

Source, with minor adaptations: SFRWQCB. (2002) Erosion and Sediment Control Field Manual, Table 1, p. 46.

Method	Selection	Site Preparation	Recommended Application Rate	
Chemicals – Inorganic				
Water	<ul style="list-style-type: none"> - Most commonly used practice - Evaporates quickly - Lasts less than 1 day - Approved dust control agents are preferred over water drafting and application 	For all liquid agents: 1. Blade a smooth surface. 2. Crown or slope to avoid ponding. 3. Compact soils if needed. 4. Uniformly pre-wet at 0.14-1.4 L/m ² (0.03-0.3 gal/yd ²). 5. Apply solution under pressure. Overlap solution 100-300 mm (6-12 in). 6. Allow treated area to cure 0-4 hours. 7. Compact area after curing. 8. Apply 2 nd treatment before 1 st treatment becomes ineffective, using 50% application rate. 9. In low humidities, reactivate chemicals by rewetting at 0.5-0.9 L/m ² (0.1-0.2 gal/yd ²).	0.6 L/m ² (0.125 gal/yd ²) every 20 to 30 minutes.	
Salts:				
<ul style="list-style-type: none"> • Calcium Chloride (CaCl) 	<ul style="list-style-type: none"> - Restricts evaporation - Lasts 6-12 months - Can be corrosive - Less effective in low humidity - Can build up in soils and leach by rain 			Apply 38% solution at 1.21 L/m ² (0.27 gal/yd ²) or as loose, dry granules per manufacturer.
<ul style="list-style-type: none"> • Magnesium Chloride (MgCl) 	<ul style="list-style-type: none"> - Restricts evaporation - Works at higher temps. and lower humidity than CaCl - May be more costly than CaCl 			Apply 26-32% solution at 2.3 L/m ² (0.5 gal/yd ²)
<ul style="list-style-type: none"> • Sodium Chloride (NaCl) 	<ul style="list-style-type: none"> - Effective over smaller range of conditions - Less expensive - Can be corrosive - Less effective in low humidity 			Per manufacturer.
Silicates	<ul style="list-style-type: none"> - Generally expensive - Available in small quantities - Require second application 			

Method	Selection	Site Preparation	Recommended Application Rate
Surfactants	<ul style="list-style-type: none"> - High evaporation rates - Effective for short periods - Must apply frequently 		
Chemicals – Organic			
Copolymers	<ul style="list-style-type: none"> - Form semipermeable transparent crust - Resist ultraviolet radiation and moisture-induced breakdown - Last 1-2 years 	Same as above (Chemicals – Inorganic)	750-940 L/ha (80-100 gal/ac)
Petroleum Products	<ul style="list-style-type: none"> - Bind soil particles - May hinder foliage growth - Environmental and aesthetic concerns - Higher cost 		Use 57-63% resins as base. Apply at 750-940 L/ha (80-100 gal/ac).
Lignin Sulfonate	<ul style="list-style-type: none"> - Paper industry waste product - Acts as dispersing agent - Best in dry climates - Can be slippery 		Loosen surface 25-50 mm (1-2 in). Need 4-8% fines.
Vegetable Oils	<ul style="list-style-type: none"> - Coat grains of soil, so limited binding ability - May become brittle - Limited availability 		Per manufacturer.
Spray-on Adhesives	<ul style="list-style-type: none"> - Available as organic or synthetic - Effective on dry, hard soils - Form a crust - Can last 3-4 years 		Per manufacturer.