

**CONTRACT DOCUMENTS FOR**  
**OPERATIONS CONCRETE CONTRACT**

(Notice Inviting Bids, Instructions to Bidders, Bid Forms, General Conditions,  
Special Provisions, Technical Specifications, Construction Agreement,  
Bond Forms, Appendix and City Standards)

**CITY OF PETALUMA - SONOMA COUNTY - CALIFORNIA**

Department of Public Works and Utilities  
202 N. McDowell Blvd., Petaluma, CA 94954  
Phone: (707) 778-4546 Fax: (707) 778-4508

Questions concerning interpretation of improvement plans, special provisions,  
contract documents and bid items shall be directed to:

***Department of Public Works and Utilities***  
***202 N. McDowell Boulevard***  
***Petaluma, CA. 94954***  
***Phone: (707) 778-4546 Fax: (707) 206-6034***

Attention: Kent Carothers, P.E.

Office Hours: Monday thru Friday - 8:00 to 4:00 p.m.

**Bid Opening: February 25, 2021 at 2:30 p.m.**

CITY OF PETALUMA  
PETALUMA, CALIFORNIA

# OPERATIONS CONCRETE CONTRACT

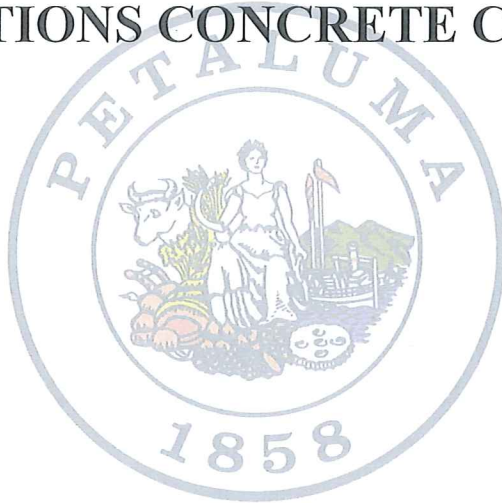

CITY OF PETALUMA - SONOMA COUNTY - CALIFORNIA

Prepared by:

A handwritten signature in blue ink, appearing to read "Kent Carothers", is written over a horizontal line.

Kent Carothers, P.E.

1/22/21  
Date



## TABLE OF CONTENTS

<b>SECTION</b>	<b>DESCRIPTION</b>
	Notice Inviting Bids Instruction to Bidders
<b>I.</b>	<b>BID FORMS (To Be Submitted With Bids)</b>
	Non-Collusion Affidavit Bid Proposal Certificate (if Corporation/if Partnership/if Joint Venture) Proposal Bid Schedule List of Subcontractors List of Materials, Suppliers and Material Guarantee Questionnaire and Financial Assurance Statement Form Bid Bond
<b>II.</b>	<b>GENERAL CONDITIONS</b>
	Article 1: Definitions Article 2: Preliminary Matters Article 3: Intent and Use of Contract Documents Article 4: Site of the Work Article 5: Bonds and Insurance Article 6: Contractor's Responsibilities Article 7: Other Work Article 8: City's Responsibilities Article 9: Engineer's Status during Construction Article 10: Changes in the Work Article 11: Change of Contract Price Article 12: Change of Contract Times Article 13: Inspections and Tests; Correction, Removal or Acceptance of Defective Work Article 14: Payments to Contractor and Completion Article 15: Suspension of Work and Termination Article 16: General Terms Article 17: California State Requirements
<b>III.</b>	<b>SPECIAL PROVISIONS</b>
	Section 3-1 Description of Work Section 3-2 Hours of Work Section 3-3 Order of Precedence of Contract Documents Section 3-4 Cooperation

Section 3-5	Obstructions
Section 3-6	Working Days
Section 3-7	Progress Schedule
Section 3-8	Superintendence
Section 3-9	Watering
Section 3-10	Beginning of Work, Contract Time, Time of Completion, and Liquidated Damages
Section 3-11	Order of Work
Section 3-12	Safety Requirements
Section 3-13	Project Appearance
Section 3-14	Responsibility for Damage
Section 3-15	Guarantee of Work
Section 3-16	Permit
Section 3-17	Wage Rates
Section 3-18	Item Increases and Decreases
Section 3-19	Maintaining Traffic
Section 3-20	Traffic Control System for Lane Closure
Section 3-21	Construction Area Signs
Section 3-22	Notice of Potential Claim
Section 3-23	Access to Driveways
Section 3-24	Existing Water Valves, Monuments, and Manholes
Section 3-25	City Standard Drawings

**IV. TECHNICAL SPECIFICATIONS**

Section 20	Dust Control
Section 30	Mobilization
Section 50	Traffic Control
Section 80	Earthwork
Section 180	Final Cleanup
Section 190	Preservation of Property
Section 220	Aggregate Base
Section 400	Minor Concrete

**V. CONSTRUCTION AGREEMENT**

Agreement
Agreement Certificates
Faithful Performance Bond
Labor and Materials Bond
Maintenance Bond

**VI. CITY STANDARD DRAWINGS**

**VII. LOCATION EXHIBITS**

## **NOTICE INVITING BIDS**

1. **RECEIPT OF BIDS:** Sealed Bids will be received at the office of the City Clerk of the City of Petaluma located at 11 English Street, Room 4, Petaluma, California, 94952-2610, until 2:30 PM (enter time) on Thursday, February 25, 2021, for the Operations Concrete Contract. Any Bids received after the specified time and date will not be considered. Fax and other electronically transmitted Bids will not be accepted.
2. **OPENING OF BIDS:** The Bids will be publicly opened and read at 2:30 PM (enter time) on Thursday, February 25, 2021 at the above-mentioned office of the CITY. The CITY reserves the right to postpone the date and time for opening of Bids at any time prior to the aforesaid date and time.
3. **COMPLETION OF WORK:** The WORK must be completed within 45 working days after the commencement date stated in the Notice to Proceed.
4. **DESCRIPTION OF WORK:** The WORK includes furnishing all labor, materials, equipment and services necessary to perform concrete sidewalk construction. The work includes removal of existing broken up concrete sidewalk and replacement of concrete section per City Standards. The project also involves construction of new sidewalk section on Lakeville and a portion off McDowell. The project includes complete removal of concrete sidewalks, curbs, gutters, driveways, curb ramps, and miscellaneous concrete repairs as may be requested by the City of Petaluma. The exhibits in the bid documents show the location of the project, but specific locations of the removal and replacement will be determined at the pro-con as will the meandering sidewalk on Lakeville. All work shall include necessary vehicular and pedestrian traffic control.
5. **SITE OF WORK:** The site of the WORK is located: Around Lucchesi Pond, parking lot at 202 North McDowell, areas near the Boys and Girls Club on Maria, concrete sections on East Washington from Ely to Sutter, and Casa Grande Road across from Casa Grande High School.
6. **OBTAINING CONTRACT DOCUMENTS:** The Contract Documents are entitled "Operations Concrete Contract."

The Contract Documents may be obtained by 4:00 P.M., Monday through Thursday at the office of Public Work & Utilities, 202 North McDowell Boulevard, Petaluma, California 94954.

If you would like to receive the bid document via the CITY's website, at no cost, please go to:

- <https://cityofpetaluma.org/bid-opportunities-2/>
- Fill out the Plan Holder's form by clicking on the Plan Holder's form link
- Fill in all fields
- Click on the submit button at the end of the form

Submitting the Plan Holder's form on-line automatically puts you on the CITY's Bidders List and you will be notified of any Addendums or information pertaining to the bid by email.

If you would like to purchase bid documents, please call Phone No. (707) 778-4585, Attention: Tiffany Avila, upon payment of \$25.00 (non-refundable) for each set of Contract Documents (including technical specification and accompanying reduced scale drawings). The scale of

the reduced drawings is about one-half of the original scale. At the Bidder's request and expense, the Contract Documents may be sent by overnight mail.

Full-scale drawings are not available.

If full-scale drawings are available and desired, they may be purchased at reproduction cost from \_\_\_\_\_.

7. **BID SECURITY:** Each Bid shall be accompanied by a certified or cashier's check or Bid Bond executed by an admitted surety in the amount of 10% percent of the Total Bid Price payable to the City of Petaluma as a guarantee that the Bidder, if its Bid is accepted, will promptly execute the Agreement. A Bid shall not be considered unless one of the forms of Bidder's security is enclosed with it. Upon acceptance of the Bid, if the Bidder refuses to or fails to promptly execute the Agreement the Bidder's security shall be forfeited to the CITY.
8. **CONTRACTOR'S LICENSE CLASSIFICATION:** In accordance with the provisions of California Public Contract Code Section 3300, the CITY has determined that the CONTRACTOR shall possess a valid Class A, B, or C8 license at the time that the Contract is awarded. Failure to possess the specified license shall render the Bid as non-responsive and shall act as a bar to award of the Contract to any bidder not possessing said license at the time of award.
9. **PREFERENCE FOR MATERIAL:** Substitute products will be considered prior to award of the Contract in accordance with Section 3400 of the California Public Contract Code. The Bidder will submit data substantiating its request for a substitution of "an equal" item within 14 days following submission of its Bid. Substantiation date will conform to the requirements of the instructions for Proposed Substitutions of "or equal" items contained in the bid Forms. The ENGINEER will make a determination of approval or rejection of the proposed substitution prior to the award of the Contract. No request for substitution of "an equal" items will be considered by the ENGINEER after award of the Contract.
10. **REJECTION OF PROPOSALS:** The CITY reserves the right to reject all or any part of all bids submitted, waive informalities and irregularities, and will not, to the extent allowed by law, be bound to accept the lowest bid.
11. **BIDS TO REMAIN OPEN:** The Bidder shall guarantee the total bid price for a period of 90 calendar days from the date of bid opening.
12. **CALIFORNIA WAGE RATE REQUIREMENTS:** In accordance with the provisions of California Labor Code Sections 1770, 1773, 1773.1, and 1773.7 as amended, the Director of the Department of Industrial Relations has determined the general prevailing rate of per diem wages in accordance with the standards set forth in Section 1773 for the locality in which the WORK is to be performed. A copy of said wage rates is on file at the office of the City Clerk. It shall be mandatory upon the CONTRACTOR to whom the WORK is awarded and upon any subcontractor under the CONTRACTOR to pay not less than said specified rates to all workers employed by them in the execution of the WORK.
13. **LABOR COMPLIANCE PURSUANT TO CALIFORNIA LABOR CODE §1771.1:** A contractor or subcontractor shall not be qualified to bid on, be listed in a bid proposal, subject to the requirement of Section 4104 of the Public Contract Code or engage in the performance of any contract for public work, as defined in this chapter, unless currently registered and qualified to perform public work pursuant to Section 1725.5. It is not a violation of this section

for unregistered contractor to submit a bid that is authorized by Section 7029.1 of the Business and Professions Code or by Section 10164 or 20103.5 of the Public Contract Code, provided the contractor is registered to perform public work pursuant to Section 1725.5 at the time contract is awarded.

14. **RETAINAGE FROM PAYMENTS:** The CONTRACTOR may elect to receive 100 percent of payments due under the Contract Documents from time to time, without retention of any portion of the payment by the CITY, by depositing securities of equivalent value with the CITY in accordance with the provisions of Section 22300 of the Public Contract Code. Alternatively, the CONTRACTOR may request, and the CITY shall make payment of retentions earned directly to the escrow agent at the expense of CONTRACTOR. At the expense of the CONTRACTOR, the CONTRACTOR may direct the investments of the payments into securities and the CONTRACTOR shall receive the interest earned on the investments upon the same terms as provided in Section 22300 of the Public Contract Code for securities deposited by the CONTRACTOR. The CONTRACTOR shall be responsible for paying all fees for the expenses incurred by the escrow agent in administering the escrow account and all expenses of the CITY. These expenses and payment terms shall be determined by the CITY's Finance Director or his/her designee and the escrow agent. Upon satisfactory completion of the WORK, the CONTRACTOR shall receive from the escrow agent all securities, interest, and payments received by the escrow agent from the CITY, pursuant to the terms of Section 22300 of the Public Contract Code. Such securities, if deposited by the CONTRACTOR, shall be valued by the CITY, whose decision on valuation of the securities shall be final. Securities eligible for investment under this provision shall be limited to those listed in Section 16430 of the Government Code, bank or savings and loan certificates of deposit, interest-bearing demand deposit accounts, standby letters of credit, or any other security mutually agreed to by the CONTRACTOR and the CITY.
15. **PAYMENT BOND:** Pursuant to and in accordance with California Civil Code Section 3247, a payment (labor and materials) bond must be filed if the expenditure for the WORK is in excess of Twenty-Five Thousand Dollars (\$25,000).
16. **PRE-BID CONFERENCE VISITS:** [At least on box below MUST be checked]

**Check if no pre-bid conference/site is to be held:** \_\_\_\_\_.

**Mandatory pre-bid conference/site visit to be held:** Prospective bidders are required to attend a mandatory pre-bid conference/site visit at \_\_\_\_\_ (enter time) on \_\_\_\_\_, at the \_\_\_\_\_, offices at \_\_\_\_\_. Prospective bidders that fail to attend the mandatory pre-bid conference/site visit will be ineligible to bid on the project. Following the conference at City offices, City staff and prospective bidders will meet at the project Site. Transportation to the project site will be the responsibility of prospective bidders. The purposes of the conference/site visit are to discuss the scope of the project and bidding requirements and to acquaint bidders with Site conditions.

No information communicated at the pre-bid conference/site visit may amend the project bidding requirements. Project bidding requirements may only be amended by addenda issued by authorized City officials. Following the pre-bid conference/site visit, prospective bidders may submit detailed technical questions in writing. If warranted, the City may respond to such questions by addenda.



- Non-Mandatory pre-bid conference/site visit to be held:** Prospective bidders are invited to attend a non-mandatory pre-bid conference/site visit at \_\_\_\_\_ (*enter time*) on \_\_\_\_\_, at the \_\_\_\_\_. Following the conference at City offices, City staff and prospective bidders will meet at the project Site. Transportation to the project site will be the responsibility of prospective bidders. The purposes of the conference/site visit are to discuss the scope of the project and bidding requirements, and to acquaint bidders with Site conditions.

No information communicated at the pre-bid conference/site visit may amend the project bidding requirements. Project bidding requirements may only be amended by addenda issued by authorized City officials. Following the pre-bid conference/site visit, prospective bidders may submit detailed technical questions in writing. If warranted, the City may respond to such questions by addenda.

17. **PROJECT ADMINISTRATION:** All communications relative to the WORK shall be directed to the ENGINEER prior to opening of the Bids.

NAME: Kent Carothers, P.E.

ADDRESS: 202 N. McDowell Blvd.  
Petaluma, CA 94954

PHONE: (707) 778-4580

18. **CITY'S RIGHTS RESERVED:** The CITY reserves the right to reject any or all bids, to waive any minor irregularity in a bid, and to make awards to the lowest responsive, responsible bidder as it may best serve the interest of the CITY.

CITY: Petaluma

BY: SPascoe

DATE: 2/1/21

END OF NOTICE INVITING BIDS

## **INSTRUCTIONS TO BIDDERS**

1. **DEFINED TERMS.** Terms used in these Instructions to Bidders and the Notice Inviting Bids which are defined in the General Conditions have the meanings assigned to them in the General Conditions. The term “Bidder” means one who submits a Bid directly to CITY, as distinct from a sub-bidder, who submits a price or quote to a Bidder.
2. **LOCAL BUSINESS LICENSE.** All CONTRACTORS, including subcontractors, not already having a local business license for the work contemplated, will be required to secure the appropriate license before a Contract can be executed.
3. **INTERPRETATIONS AND ADDENDA.**
  - 3.1 All questions about the meaning or intent of the Contract Documents are to be directed to the ENGINEER. Additions, deletions, or revisions to the Contract Documents considered necessary by the ENGINEER in response to such questions will be issued by Addenda mailed or delivered to all parties recorded by the ENGINEER as having received the Contract Documents. Questions received less than 14 days prior to the date of Bids may not be answered. Only answers to such questions issued by formal written Addenda will be binding. Oral and other interpretations or clarifications will be without legal effect.
  - 3.2 Addenda may also be issued to make other additions, deletions, or revisions to the Contract Documents.
  - 3.3 Bidders shall make no special interpretation or inference of intent from differing formats in the Technical Specifications.
4. **BIDDER’S EXAMINATION OF CONTRACT DOCUMENTS AND SITE.**
  - 4.1 It is the responsibility of each Bidder before submitting a Bid:
    - A. To examine thoroughly the Contract Documents and other related data identified in the Bidding Documents (including “technical” data referred to below);
    - B. To visit the site to become familiar with local conditions that may affect cost, progress, or performance of the WORK;
    - C. To consider federal, state, and local Laws and Regulations that may affect cost, progress, or performance of the WORK;
    - D. To study and carefully correlate the Bidder’s observations with the Contract Documents; and

- E. To notify the ENGINEER of all conflicts, errors, ambiguities, or discrepancies in or between the Contract Documents and such other related data.
- 4.2 Reference is made to the Supplementary General Conditions for identification of:
- A. Those reports of explorations and tests of subsurface conditions at the site which have been utilized by the ENGINEER in the preparation of the Contract Documents.
  - B. Those drawings of physical conditions in or relating to existing surface and subsurface conditions (except Underground Utilities) which are at or contiguous to the site which have been utilized by the ENGINEER in the preparation of the Contract Documents.
  - C. Those environmental reports or drawings relating to Asbestos, Hazardous Waste, PCBs, Petroleum, and/or Radioactive Materials identified at the site which have been utilized by the ENGINEER in the preparation of the Contract Documents.
  - D. The ENGINEER makes no representation as to the completeness of the reports or drawings referred to in Paragraphs 4.2A, 4.2B, and 4.2C. above or the accuracy of any data or information contained therein. The Bidder may rely upon the accuracy of the technical data contained in such reports and drawings. However, the Bidder may not rely upon any interpretation of such technical data, including any interpretation or extrapolation thereof, or any non-technical data, interpretations, and opinions contained therein.
- 4.3 Copies of reports and drawings referred to in Paragraph 4.2 will be made available by the CITY to any Bidder on request, if said reports and drawings are not bound herein. Those reports and drawings are not part of the Contract Documents, but the technical data contained therein upon which the Bidder is entitled to rely, are incorporated herein by reference.
- 4.4 Information and data reflected in the Contract Documents with respect to Underground Utilities at or contiguous to the site are based upon information and data furnished to the ENGINEER by the owners of such Underground Utilities or others, and the CITY does not assume responsibility for the accuracy or completeness thereof unless it is expressly provided otherwise in the Supplementary General Conditions.
- 4.5 Provisions concerning responsibilities for the adequacy of data furnished to prospective Bidders on subsurface conditions, Underground Utilities, and other physical conditions, and possible changes in the Contract Documents due to differing conditions appear in Paragraphs 4.2, 4.3, and 4.4 of the General Conditions.
- 4.6 Before submitting a Bid, each Bidder will, at Bidder's own expense, make or obtain any additional examinations, investigations, explorations, tests, and studies and obtain any additional information and data which pertain to the physical conditions (surface,

subsurface, and Underground Utilities) at or contiguous to the site or otherwise which may affect cost, progress, or performance of the WORK and which the Bidder deems necessary to determine its Bid for performing the WORK in accordance with the time, price, and other terms and conditions of the Contract Documents.

- 4.7 On request a minimum of 2 working days in advance, the ENGINEER will provide each Bidder access to the site to conduct such examinations, investigations, explorations, tests, and studies as each Bidder deems necessary for submission of a Bid. Location of any excavation or boring shall be subject to prior approval of ENGINEER and applicable agencies. Bidder shall fill all holes, restore all pavement to match existing structural section, and shall clean up and restore the site to its former condition upon completion of such explorations. ENGINEER reserves the right to require Bidder to execute an Access Agreement with the CITY prior to accessing the site.
- 4.8 The lands upon which the WORK is to be performed, rights-of-way, and easements for access thereto and other lands designated for use by the CONTRACTOR in performing the WORK are identified in the Contract Documents. All additional lands and access thereto required for temporary construction facilities or storage of materials and equipment are to be provided by the CONTRACTOR. Easements for permanent structures or permanent changes in existing structures are to be obtained and paid for by the CITY unless otherwise provided in the Contract Documents.
- 4.9 The submission of a Bid will constitute an incontrovertible representation by the Bidder that the Bidder has complied with every requirement of this Paragraph 4 and the following:
  - A. That the Bid is premised upon performing the WORK required by the Contract Documents without exception and such means, methods, techniques, sequences, or procedures of construction (if any) as may be required by the Contract Documents;
  - B. That Bidder has given the ENGINEER written notice of all conflicts, errors, ambiguities, and discrepancies in the Contract Documents and the written resolution thereof by the ENGINEER is acceptable to the Bidder; and
  - C. That the Contract Documents are sufficient in scope and detail to indicate and convey understanding of all terms and conditions for performance of the WORK.
5. **BID FORMS.** The Bid shall be submitted on the Bid Forms provided by the City. All blanks on the Bid Forms shall be completed in ink. All names must be printed below the signatures. The Bid shall be submitted in a sealed envelope which shall be plainly marked in the upper left hand corner with the name and address of the Bidder and shall bear the words "BID FOR" followed by the title of the Contract Documents for the WORK, the name of the CITY, the address where Bids are to be delivered or mailed to, and the date and hour of opening of Bids.

- 5.2 The Bid must set forth the name and location of the place of business of each subcontractor who will perform work or labor or render service to the prime contractor in or about the construction of the WORK, or a subcontractor licensed by the State of California who, under subcontract to the prime contractor, specially fabricates and installs a portion of the WORK according to detailed Drawings contained in the plans and specifications, in an amount in excess of one-half of 1 percent of the prime contractor's total bid or, in the case of bids or offers for the construction of streets and highways, including bridges, in excess of one-half of 1 percent of the prime contractor's total bid or ten thousand dollars (\$10,000), whichever is greater.
6. CERTIFICATES.
- 6.1 Bids by corporations must be executed in the corporate name by the president, a vice-president, or other corporate officer. Such Bid shall be accompanied by the enclosed Certificate of Authority to sign, attested by the secretary or assistant secretary, and with the corporate seal affixed. The corporate address and state of incorporation must appear below the signature.
- 6.2 Bids by partnerships must be executed in the partnership name and be signed by a managing partner, accompanied by the enclosed Certificate of Authority to sign, and his/her title must appear under the signature and the official address of the partnership must appear below the signature.
- 6.3 Bids by joint venture must be executed in the joint venture name and be signed by a joint venture managing partner, accompanied by the enclosed Certificate of Authority to sign, and his/her title must appear under the signature and the official address of the joint venture must appear below the signature.
7. DISQUALIFICATION OF BIDDERS. More than one Bid from an individual, firm, partnership, corporation, or association under the same or different names will not be considered. If the CITY believes that any Bidder is interested in more than one Bid for the WORK contemplated, all Bids in which such Bidder is interested will be rejected. If the CITY believes that collusion exists among the Bidders, all Bids will be rejected. A party who has quoted prices to a bidder is not hereby disqualified from quoting prices to other Bidders, or from submitting a Bid directly for the WORK. If a Bidder is not registered with the Department of Industrial Relations pursuant to Labor Code Section 1725.5 and Section 1771.1, then the Bid may be rejected as non-responsive.
8. QUANTITIES OF WORK. The quantities of work or material stated in unit price items of the Bid are supplied only to give an indication of the general scope of the WORK; the OWNER does not expressly or by implication agree that the actual amount of work or material will correspond therewith, and reserves the right after award to increase or decrease the quantity of any unit price item of the WORK by an amount up to and including 25 percent of any Bid item in its entirety, or to add additional Bid items up to and including an aggregate total amount not to exceed 25 percent of the Bid price.

9. **SUBSTITUTE OR “OR EQUAL” ITEMS.** Whenever materials or equipment are specified or described in the Contract Documents by using the name of a particular manufacturer and the name is followed by the words “or equal”, the Bidder may write the name of a substitute manufacturer (which the Bidder considers as an “or equal”) in the List of Proposed Substitutions in the Bid Forms. The ENGINEER will make a determination of approval or rejection of the proposed substitution prior to award of the Contract. No request for substitution of an “or equal” item will be considered by the ENGINEER after award of the Contract. The procedure for the submittal of substitute or “or equal” products is contained in the Bid Forms. The Bidder shall not be relieved of any obligations of the Contract Documents or be entitled to an adjustment in the Contract Price in the event any proposed substitution is not approved.
10. **COMPETENCY OF BIDDERS.** In selecting the lowest responsive, responsible Bidder, consideration will be given not only to the financial standing but also to the general competency of the Bidder for the performance of the WORK covered by the Bid. To this end, each Bid shall be supported by a statement of the Bidder’s experience as of recent date including: (a) all projects worked on by the Bidder over the past three (3) years including the contract amount for each project; (b) all complaints made against the Contractor’s license in the past ten (10) years; and (c) all claims and lawsuits presented or filed in the last five (5) years, regardless of the form, regarding any public works project.
11. **SUBMISSION OF BIDS.** The Bid shall be delivered by the time and to the place stipulated in the Notice Inviting Bids. It is the Bidder’s sole responsibility to see that its Bid is received in proper time and at the proper place.
12. **BID SECURITY, BONDS, AND INSURANCE.** Each Bid shall be accompanied by a certified or cashier’s check or approved Bid Bond in the amount stated in the Notice Inviting Bids. Said check or bond shall be made payable to the CITY and shall be given as a guarantee that the Bidder, if awarded the WORK, will enter into an Agreement with the CITY and will furnish the necessary insurance certificates, Payment Bond, and Performance Bond. In case of refusal or failure to enter into said Agreement, the check or Bid Bond, as the case may be, shall be forfeited to the CITY. If the Bidder elects to furnish a Bid Bond as its Bid security, the Bidder shall use the Bid Bond form bound herein. Bid Bonds shall comply with the requirements applicable to payment and performance bonds in the General Conditions.
- 12.1 **BIDDING CAPACITY.** Each Bid shall be accompanied by a list of the projects currently being worked on by Bidder, their size, contract price, scheduled completion date, location, and owner. Additionally, Bidder shall provide certified evidence of its current bonding capacity.
13. **DISCREPANCIES IN BIDS.** In the event there is more than one Bid item in a Bid Schedule, the Bidder shall furnish a price for all Bid Items in the Schedule, and failure to do so will render the Bid non-responsive and shall cause its rejection. In the event there are unit price Bid items in a Bidding schedule and the amount indicated for a unit price Bid item does not equal the product of the unit price and quantity, the unit price shall

govern and the amount will be corrected accordingly, and the BIDDER shall be bound by said correction. In the event there is more than one Bid item in a Bid Schedule and the total indicated for the Schedule does not agree with the sum of the prices Bid on the individual items, the prices Bid on the individual items shall govern and the total for the Schedule will be corrected accordingly, and the BIDDER shall be bound by said correction.

14. **MODIFICATIONS AND UNAUTHORIZED ALTERNATIVE BIDS.** Unauthorized conditions, limitations, or provisos attached to the Bid shall render it informal and may cause its rejection as being non-responsive. The Bid forms shall be completed without interlineations, alterations, or erasures in the printed text. Alternative Bids will not be considered unless called for. Oral, telegraphic, or telephonic Bids or modifications will not be considered.
15. **WITHDRAWAL OF BID.** The Bid may be withdrawn by the Bidder by means of a written request, signed by the Bidder or its properly authorized representative. Such written request must be delivered to the place stipulated in the Notice Inviting Bids for receipt of Bids prior to the scheduled closing time for receipt of Bids.
16. **BID PROTEST.** Any Bid protest must be submitted in writing to the City Manager before 5:00 p.m. on the fifth (5<sup>th</sup>) working day following Bid opening.
  - A. The initial protest document must contain a complete statement of the basis for the protest, and all supporting documentation.
  - B. The party filing the protest must have actually submitted a Bid for the WORK. A subcontractor of a party submitting a Bid for the WORK may not submit a Bid protest. A party may not rely on the Bid protest submitted by another Bidder, but must timely pursue its own protest.
  - C. The protest must refer to the specific portion of the bid document which forms the basis for the protest.
  - D. The protest must include the name, address and telephone number of the person representing the protesting party.
  - E. The party filing the protest must concurrently transmit a copy of the initial protest document and any attached documentation to all other parties with a direct financial interest which may be adversely affected by the outcome of the protest. Such parties shall include all other Bidders who appear to have a reasonable prospect of receiving an award depending upon the outcome of the protest.
  - F. The CITY will give the protested Bidder five (5) working days after the receipt of the protest to submit a written response. The responding Bidder shall transmit the response to the protesting Bidder concurrent with delivery to the CITY.



- G. The procedure and time limits set forth in this paragraph are mandatory and are the Bidder's sole and exclusive remedy in the event of Bid protest. The Bidder's failure to comply with these procedures shall constitute a waiver of any right to further pursue the Bid protest, including filing a Government Code Claim or legal proceedings. A Bidder may not rely on a protest submitted by another Bidder, but must timely pursue its own protest.
- H. If the CITY determines that a protest is frivolous, the protesting bidder may be determined to be non-responsible and that bidder may be determined to be ineligible for future contract awards.
17. **AWARD OF CONTRACT.** Award of the contract, if awarded, will be made to the lowest responsive, responsible Bidder whose Bid complies with the requirements of the Contract Documents. Unless otherwise specified, any such award will be made within the period stated in the Notice Inviting Bids that the bids are to remain open. Unless otherwise indicated, a single award will be made for all the Bid items in an individual Bid Schedule. In the event the WORK is contained in more than one Bid Schedule, the CITY may award Schedules individually or in combination. In the case of two Bid Schedules which are alternative to each other, only one of such alternative schedules will be awarded. The CITY may condition the award upon the Bidder's timely submission of all items required by the Contract Documents, including, but not limited to the executed Agreement, performance, labor and materials, and maintenance bonds, and required certificates of insurance and endorsements.
18. **RETURN OF BID SECURITY.** Within 14 days after award of the contract, the CITY will, if requested, return the Bid securities accompanying such Bids that are not being considered in making the award. All other Bid securities will be held until the Agreement has been finally executed. They will then be returned, if requested, to the respective Bidders whose Bids they accompany.
19. **EXECUTION OF AGREEMENT.** The Bidder to whom award is made shall execute a written Agreement with the CITY on the form of agreement provided, shall secure all insurance, and shall furnish all certificates and bonds required by the Contract Documents within five (5) working days after receipt of Notice of Award from the CITY. Failure or refusal to enter into an Agreement as herein provided or to conform to any of the stipulated requirements in connection therewith shall be just cause for annulment of the award and forfeiture of the Bid security. If the lowest responsive, responsible Bidder refuses or fails to execute the Agreement, the CITY may award the Contract to the second lowest responsive, responsible Bidder. If the second lowest responsive, responsible Bidder refuses or fails to execute the Agreement, the OWNER may award the contract to the third lowest responsive, responsible Bidder. On the failure or refusal of such second or third lowest Bidder to execute the Agreement, each such Bidder's Bid securities shall be likewise forfeited to the CITY.
20. **LIQUIDATED DAMAGES.** Provisions for liquidated damages, if any, are set forth in the Agreement.

21. **WORKERS' COMPENSATION REQUIREMENT.** The Bidder should be aware that in accordance with Section 3700 of the California Labor Code it will, if awarded the Contract, be required to secure the payment of compensation to its employees and execute the Workers' Compensation Certification in the form contained in these Contract Documents.
22. **NON-COLLUSION AFFIDAVIT.** Bidders must execute the following affidavit and submit the same with his/her bid:
23. **MATERIALS SUPPLIERS LIST.** Bidders and their subcontractors must complete the List of Materials Suppliers and Material Guarantee form provided with the Bid Forms and must submit the completed form with the Bid.

END OF INSTRUCTIONS TO BIDDERS

**SECTION I**

**BID FORMS**

**(TO BE SUBMITTED WITH BIDS)**



BID PROPOSAL CERTIFICATE  
(if Partnership)

STATE OF CALIFORNIA    )  
  ) ss:  
COUNTY OF                    )

I HEREBY CERTIFY that a meeting of the Partners of the \_\_\_\_\_  
\_\_\_\_\_,  
a partnership existing under the laws of the State of \_\_\_\_\_, held  
on \_\_\_\_\_, 20\_\_\_\_, the following resolution was duly passed and adopted:

“RESOLVED, that \_\_\_\_\_, as the  
General Partner of the Partnership, be and is hereby authorized to execute the Bid  
Proposal dated \_\_\_\_\_, 20\_\_\_\_, for the \_\_\_\_\_  
project, in the City of Petaluma and that his/her execution thereof, attested by the  
\_\_\_\_\_ shall be the official act and deed of this Partnership.”

I further certify that said resolution is now in full force and effect.

IN WITNESS WHEREOF, I have hereunto set my hand this \_\_\_\_\_ day of  
\_\_\_\_\_, 20\_\_\_\_.

\_\_\_\_\_  
Partner

(SEAL)

BID PROPOSAL CERTIFICATE  
(if Joint Venture)

STATE OF CALIFORNIA    )  
  ) ss:  
COUNTY OF                    )

I HEREBY CERTIFY that a meeting of the Principals of the \_\_\_\_\_  
\_\_\_\_\_  
\_\_\_\_\_  
a joint venture existing under the laws of the State of \_\_\_\_\_,  
held on \_\_\_\_\_, 20\_\_\_, the following resolution was duly passed and adopted:

“RESOLVED, that \_\_\_\_\_, as  
\_\_\_\_\_ of the joint venture, be and is hereby authorized to  
execute the Bid Proposal dated \_\_\_\_\_, 20\_\_\_, for the \_\_\_\_\_  
\_\_\_\_\_ project, in the City of Petaluma, and  
that his/her execution thereof, attested by the \_\_\_\_\_ shall be the  
official act and deed of this Joint Venture.”

I further certify that said resolution is now in full force and effect.

IN WITNESS WHEREOF, I have hereunto set my hand this \_\_\_\_\_, day of  
\_\_\_\_\_, 20\_\_\_.

\_\_\_\_\_  
Managing Partner

(SEAL)

BID PROPOSAL CERTIFICATE  
(if Proprietorship)

STATE OF CALIFORNIA )  
                                  ) ss:  
COUNTY OF                                 )

I HEREBY CERTIFY that \_\_\_\_\_, as owner of  
\_\_\_\_\_ that I am authorized to execute the  
Bid Proposal dated \_\_\_\_\_, 20\_\_\_\_, for the \_\_\_\_\_  
\_\_\_\_\_ project, in the City of Petaluma, and that my execution  
thereof shall be the official act and deed of this proprietorship.

IN WITNESS WHEREOF, I have hereunto set my hand and affixed the official seal of  
the corporation this \_\_\_\_\_, day of \_\_\_\_\_, 20\_\_\_\_\_.

\_\_\_\_\_  
Owner

(SEAL)

# PROPOSAL

To the City Council of the City of Petaluma:

The undersigned declares that he/she has carefully examined the location of the proposed work, that he/she has examined the plans and specifications, and read the accompanying instructions to bidders, and hereby proposes to furnish all materials and do all the work required to complete the said work in accordance with said plans, specifications, and special provisions for the unit or lump sum prices set forth in the attached Bid Schedule.

It is understood and agreed that the undersigned shall complete the work of the contract within the time provided for in the Contract Documents and Specifications governing said work.

If awarded the contract, the undersigned hereby agrees to sign said contract and to furnish the necessary bonds, insurance certificates and agreements within five (5) working days after receipt of Notice of Award of said contract from the City.

The undersigned has examined the location of the proposed work and is familiar with the plans, specifications and other contract documents and the local conditions at the place where the work is to be done.

The undersigned has checked carefully all the figures on the attached Bid Schedule and understands that the City will not be responsible for any errors or omissions on the part of the undersigned in making up the bid.

Enclosed find bidder's bond, certified check, or cashier's check no. \_\_\_\_\_ of the \_\_\_\_\_ (Company) (Bank) for \_\_\_\_\_ Dollars (\$\_\_\_\_\_).

This project requires a Class A, B, Or C8 California State Contractor's License.

Contractor's License No. \_\_\_\_\_ License Class \_\_\_\_\_

Expiration Date of Contractor's License \_\_\_\_\_



This project requires registration with the California State Department of Industrial Relations.

Public Works Contractor Registration No. \_\_\_\_\_

Registration Date \_\_\_\_\_ Expiration Date \_\_\_\_\_

A bid submitted to a public agency by a contractor who is not licensed and not registered shall be considered non-responsive and shall be rejected by the public agency. The undersigned contractor declares that the contractor's license number, public work contractor registration number, and expiration dates stated herein are made under penalty of perjury under the laws of the State of California.

Contractor: \_\_\_\_\_

Signed by: \_\_\_\_\_

Title: \_\_\_\_\_

Address: \_\_\_\_\_

\_\_\_\_\_

Phone: \_\_\_\_\_

Fax: \_\_\_\_\_

Email: \_\_\_\_\_

Dated this \_\_\_\_\_ day of \_\_\_\_\_, 20\_\_\_\_.

END OF PROPOSAL

**BIDDER'S AFFIDAVIT OF NON-COLLUSION SUBMITTED WITH BID**

\_\_\_\_\_, [Contractor] hereby declares that:

He or she is \_\_\_\_\_ [title/position] of \_\_\_\_\_, [company name] the party making the foregoing bid; that the bid is not made in the interest of, or on behalf of, any undisclosed person, partnership, company, association, organization, or corporation; that the bid is genuine and not collusive or sham; that the bidder has not directly or indirectly induced or solicited any other bidder to put in a false or sham bid, and has not directly or indirectly colluded, conspired, connived, or agreed with any bidder or anyone else to put in a sham bid, or that anyone shall refrain from bidding; that the bidder has not in any manner, directly or indirectly, sought by agreement, communication, or conference with anyone to fix the bid price of the bidder or any other bidder, or to fix any overhead, profit, or cost element of the bid price, or of that of any other bidder, or to secure any advantage against the public body awarding the contract or anyone interested in the proposed contract; that all statements contained in the bid are true; and, further, that the bidder has not, directly or indirectly, submitted his or her bid price or any breakdown thereof, or the contents thereof, or divulged information or data relative thereto, or paid, and will not pay, any fee to any corporation, partnership, company, association, organization, bid depository, or to any member or agent thereof to effectuate a collusive or sham bid.

I declare under penalty of perjury under the laws of the State of California that the foregoing is true and correct.

Dated: \_\_\_\_\_

\_\_\_\_\_  
Signature

Public Contract Code section 7106  
Code of Civil Procedure section 2015.5

END OF BIDDER'S AFFIDAVIT OF NON-COLLUSION SUBMITTED WITH BID

**BID SCHEDULE**

Bid Items

<b>Item No.</b>	<b>Description</b>	<b>Estimated Quantity</b>	<b>Unit</b>	<b>Unit Price</b>	<b>Total</b>
1.	Adjust Utility Box to Grade	2	EA		
2.	Install New Concrete Sidewalk	1,480	SF		
3.	Remove and Replace Sidewalk Replacement	2,715	SF		
4.	Remove and Replace Curb and Gutter	20	LF		
5.	Driveway – Commercial	160	SF		

**Total Bid**      \$

---

---

\*Note: In case of error in extension of price into the total price column, the unit price will govern.

Total Amount of Bid (written in words) is: _____ _____ Dollars and _____ Cents. In the event of discrepancy between words and figures, the words shall prevail. \$ _____ _____ Figures
---

\_\_\_\_\_  
Address of Bidder

\_\_\_\_\_  
Signature of Bidder

\_\_\_\_\_  
City

\_\_\_\_\_  
Name of Bidder (Print)

\_\_\_\_\_  
Telephone Number of Bidder

\_\_\_\_\_  
Fax Number of Bidder

\_\_\_\_\_  
Contractor's License Number

\_\_\_\_\_  
License's Expiration Date

**Addendum Acknowledgement**

Addendum No. 1    Signature Acknowledging Receipt: \_\_\_\_\_    Date: \_\_\_\_\_

Addendum No. 2    Signature Acknowledging Receipt: \_\_\_\_\_    Date: \_\_\_\_\_

Addendum No. 3    Signature Acknowledging Receipt: \_\_\_\_\_    Date: \_\_\_\_\_

Addendum No. 3    Signature Acknowledging Receipt: \_\_\_\_\_    Date: \_\_\_\_\_

## LIST OF SUBCONTRACTORS

In accordance with the provisions of Section 4102 and 4108, inclusive, of the Government Code of the State of California, each bidder shall list below the name and location of place of business of each subcontractor who will perform a portion of the contract work in an amount in excess of one-half of one percent of the total contract price. In each such instance, the nature and extent of the work to be performed shall be described.

If a prime contractor fails to specify a subcontractor or if a prime contractor specifies more than one subcontractor for the same portion of work to be performed under the contract in excess of one-half of one percent of the prime contractor's total bid, the prime contractor agrees that he or she is fully qualified to perform that portion himself or herself, and that the prime contractor shall perform that portion himself or herself. The subcontracting of work for which no subcontractor was designated in the original bid and which is in excess of one-half of one percent of the total contract price, will be allowed only with the written consent of the City.

Name of Subcontractor	Address of Office, Mill, or Shop	Description of Work to be Performed (also show Bid Schedule Item Number)	Public Works Contractor Registration Number
-----------------------------	-------------------------------------	--	--

---



---



---



---



---



---



---



---



---



---

END OF LIST OF SUBCONTRACTORS

**LIST OF MATERIAL SUPPLIERS AND MATERIAL GUARANTEE**

The bidder is required to name the make and supplier of the material items listed below to be furnished under these specifications. The bidder shall name a manufacturer for each item and the supplier of the item if the supplier is not the manufacturer. The naming of more than one supplier for a single item or naming a supplier followed by the words “or equal” will not be acceptable. Substitution of any listed supplier following submission of this form with the Bid shall only be permitted as authorized by the Engineer pursuant to Section 6.3 of the General Conditions.

Failure to complete this form and submit it with the bid proposal may cause the proposal to be rejected as being incomplete and not responsive to the solicitation.

<b>Item</b>	<b>Supplier &amp; Manufacturer</b>	<b>Address</b>
Concrete		

**MATERIAL GUARANTEE**

In addition to completion of the list of material suppliers on the Material Suppliers form, the bidder may be required to furnish prior to award of contract, a complete statement of the origin, composition and manufacturer of any or all materials to be used in the construction of the work, together with samples, which samples may be subjected to test, provided for in these specifications or in the Special Provisions to determine their quality and fitness for the work.

END OF  
LIST OF MATERIAL SUPPLIERS AND MATERIAL GUARANTEE

**QUESTIONNAIRE AND FINANCIAL ASSURANCE STATEMENT**

The following statements as to experience and financial qualifications of the Proposer are submitted in conjunction with the proposal as a part thereof, and the truthfulness and accuracy of the information is guaranteed by the Proposer.

The Proposer has been engaged in the contracting business under the present business for \_\_\_\_\_ years. Experience in work of a nature similar to that covered in the proposal extends over a period of \_\_\_\_\_ years.

The Proposer, as a contractor, has never failed to satisfactorily complete a contract awarded to contractor, except as follows:

---

---

---

List all claims and lawsuits presented or filed in the last five (5) years, regardless of the form, regarding any public works project:

---

---

---

The following contracts for work have been completed in the last three (3) years for the persons, firm or authority indicated and to whom reference is made:

<u>Year</u>	<u>Type of Work-Size, Length and Contract Amount</u>	<u>Location and For Whom Performed</u>
_____	_____	_____
_____	_____	_____
_____	_____	_____
_____	_____	_____

The following complaints have been made against the Proposer's contractor's license within the past ten (10) years:

Date: \_\_\_\_\_ Nature of Complaint \_\_\_\_\_

---

---



Reference is hereby made to the following bank or banks as to the financial responsibility of the proposer:

NAME OF BANK	ADDRESS

Reference is hereby made to the following surety companies as to the financial responsibility and general reliability of the proposer:

NAME OF SURETY COMPANY:

---

I, the undersigned, declare under penalty of perjury under the laws of the State of California, that the foregoing is true and correct.

\_\_\_\_\_  
SIGNATURE OF PROPOSER

\_\_\_\_\_  
DATE

\_\_\_\_\_  
NAME OF PROPOSER

END OF  
QUESTIONNAIRE AND FINANCIAL STATEMENT FORM

**BID BOND**

We, \_\_\_\_\_ as Principal, and \_\_\_\_\_ as Surety, jointly and severally, bind ourselves, our heirs, representatives, successors and assigns, as set forth herein, to the City of Petaluma (herein called "the Owner") for the payment of the penal sum of \_\_\_\_\_ Dollars (\$\_\_\_\_\_), lawful money of the United States, which is ten (10) percent of the total amount bid by bidder to the Owner. Principal has submitted the accompanying bid for the construction of the Operations Concrete Contract project.

If the Principal is awarded the contract and enters into a written contract, in the form prescribed by the Owner, at the price designated by his bid, and files the bonds required by the Agreement with the Owner, and carries all insurance in type and amount which conforms to the contract documents and furnishes required certificates and endorsements thereof, then this obligation shall be null and void; otherwise it shall remain in full force and effect.

Forfeiture of this bond, or any deposit made in lieu thereof, shall not preclude the Owner from seeking all other remedies provided by law to cover losses sustained as a result of the Principal's failure to do any of the foregoing.

Principal and Surety agree that if the Owner is required to engage the services of an attorney in connection with the enforcement of this bond, each shall pay the Owner's reasonable attorney's fees, witness fees and other costs incurred with or without suit.

Executed on \_\_\_\_\_, \_\_\_\_\_.

\_\_\_\_\_  
PRINCIPAL

By \_\_\_\_\_  
Signature

\_\_\_\_\_  
Title

Any claims under this bond may be addressed to:

\_\_\_\_\_  
\_\_\_\_\_  
\_\_\_\_\_  
\_\_\_\_\_

(Name and address of Surety's agent for service of process in California, if different from above)

(Telephone number of Surety's agent in California)

(Attach Acknowledgment)

\_\_\_\_\_  
SURETY

By \_\_\_\_\_  
(Attorney-in-Fact)

**NOTICE:**

No substitution or revision to this bond form will be accepted. Be sure that all bonds submitted have a certified copy of the bonding agent's power of attorney attached. Also verify that Surety is an "Admitted Surety" (i.e., qualified to do business in California), and attach proof of verification (website printout from the California Department of Insurance website (<http://www.insurance.ca.gov/docs/index.html>) or certificate from County Clerk).

END OF BID BOND

**SECTION II**  
**GENERAL CONDITIONS**

**CITY OF PETALUMA - GENERAL CONDITIONS**

TABLE OF CONTENTS

ARTICLE 1 - DEFINITIONS ..... 1

    Addenda..... 1

    Agreement ..... 1

    Application for Payment..... 1

    Asbestos..... 1

    Bid ..... 1

    Bonds ..... 1

    Change Order..... 1

    CITY ..... 1

    Clarification ..... 1

    Contract Documents ..... 1

    Contract Price ..... 2

    Contract Times ..... 2

    CONTRACTOR ..... 2

    Day ..... 2

    Defective Work..... 2

    Drawings..... 2

    Effective Date of the Agreement ..... 2

    ENGINEER ..... 2

    Field Order..... 2

    Hazardous Waste ..... 2

    Laws and Regulations; Laws or Regulations ..... 2

    Lien or Mechanic’s Lien..... 2

    Milestone ..... 3

    Notice of Award ..... 3

    Notice of Completion ..... 3

    Notice to Proceed..... 3

    Partial Utilization..... 3

    Petroleum..... 3

    Project..... 3

    Record Drawings ..... 3

    Resident Project Representative ..... 3

    Samples..... 3

    Shop Drawings ..... 3

    Site..... 3

    Special Provisions ..... 4

    Specifications ..... 4

    Stop Notice ..... 4

    Subcontractor ..... 4

Supplementary General Conditions.....	4
Supplier.....	4
Utilities .....	4
WORK.....	4
Working day .....	4
ARTICLE 2 - PRELIMINARY MATTERS .....	4
2.1 DELIVERY OF BONDS AND INSURANCE CERTIFICATES.....	4
2.2 COPIES OF DOCUMENTS.....	5
2.3 COMMENCEMENT OF CONTRACT TIMES; NOTICE TO PROCEED .....	5
2.4 STARTING THE WORK.....	5
2.5 PRECONSTRUCTION CONFERENCE .....	5
ARTICLE 3 - INTENT AND USE OF CONTRACT DOCUMENTS .....	5
3.1 INTENT .....	5
3.2 REFERENCE TO STANDARDS.....	6
3.3 REVIEW OF CONTRACT DOCUMENTS.....	6
3.4 ORDER OF PRECEDENCE OF CONTRACT DOCUMENTS.....	7
3.5 AMENDING CONTRACT DOCUMENTS.....	7
3.6 REUSE OF DOCUMENTS .....	7
ARTICLE 4 - SITE OF THE WORK.....	8
4.1 AVAILABILITY OF LANDS.....	8
4.2 REPORTS OF PHYSICAL CONDITIONS .....	8
4.3 PHYSICAL CONDITIONS - UNDERGROUND UTILITIES.....	9
4.4 DIFFERING SITE CONDITIONS .....	9
4.5 HAZARDOUS MATERIALS .....	10
4.6 REFERENCE POINTS.....	11
ARTICLE 5 - BONDS AND INSURANCE .....	11
5.1 BONDS .....	11
5.2 INSURANCE.....	12
ARTICLE 6 - CONTRACTOR'S RESPONSIBILITIES.....	15
6.1 COMMUNICATIONS.....	15
6.2 SUPERVISION AND SUPERINTENDENCE .....	15
6.3 LABOR, MATERIALS, AND EQUIPMENT.....	15
6.4 SCHEDULE.....	20
6.5 SUBSTITUTES OR "OR EQUAL" ITEMS .....	20
6.6 CONCERNING SUBCONTRACTORS, SUPPLIERS, AND OTHERS.....	20
6.7 PERMITS.....	20
6.8 PATENT FEES AND ROYALTIES .....	20
6.9 LAWS AND REGULATIONS.....	21
6.10 TAXES.....	21
6.11 USE OF PREMISES.....	21
6.12 SAFETY AND PROTECTION .....	22

6.13	EMERGENCIES.....	24
6.14	SUBMITTALS.....	24
6.15	CONTINUING THE WORK.....	27
6.16	CONTRACTOR’S GENERAL WARRANTY AND GUARANTEE .....	27
6.17	INDEMNIFICATION.....	29
6.18	CONTRACTOR’S DAILY REPORTS .....	31
6.19	CONTRACT DOCUMENTS AND RECORD DRAWINGS .....	31
6.20	CLEAN UP .....	32
6.21	STORM WATER POLLUTION PREVENTION .....	33
ARTICLE 7 - OTHER WORK.....		39
7.1	RELATED WORK AT SITE.....	39
7.2	COORDINATION .....	40
ARTICLE 8 - CITY’S RESPONSIBILITIES .....		40
8.1	COMMUNICATIONS.....	40
8.2	PAYMENTS .....	40
8.3	LANDS, EASEMENTS, AND SURVEYS .....	40
8.4	REPORTS AND DRAWINGS .....	40
8.5	CHANGE ORDERS .....	40
8.6	INSPECTIONS AND TESTS.....	40
8.7	SUSPENSION OF WORK .....	40
8.8	TERMINATION OF AGREEMENT .....	41
8.9	LIMITATION ON CITY’S RESPONSIBILITIES .....	41
8.10	UNDISCLOSED HAZARDOUS ENVIRONMENTAL CONDITIONS .....	41
ARTICLE 9 - ENGINEER’S STATUS DURING CONSTRUCTION .....		42
9.1	CITY’S REPRESENTATIVE .....	42
9.2	OBSERVATIONS ON THE SITE .....	42
9.3	PROJECT REPRESENTATION .....	42
9.4	CLARIFICATIONS.....	42
9.5	AUTHORIZED VARIATIONS IN WORK .....	42
9.6	REJECTING DEFECTIVE WORK .....	43
9.7	CONTRACTOR SUBMITTALS, CHANGE ORDERS, AND PAYMENTS.....	43
9.8	DECISIONS ON DISPUTES .....	43
9.9	LIMITATIONS ON ENGINEER’S RESPONSIBILITIES.....	43
ARTICLE 10 - CHANGES IN THE WORK .....		44
10.1	GENERAL .....	44
10.2	ALLOWABLE QUANTITY VARIATIONS.....	45
ARTICLE 11 - CHANGE OF CONTRACT PRICE.....		45
11.1	GENERAL .....	45
11.2	COSTS RELATING TO WEATHER .....	46
11.3	COST OF WORK (BASED ON TIME AND MATERIALS) .....	46
11.4	CONTRACTOR’S OVERHEAD AND PROFIT.....	50

11.5	EXCLUDED COSTS.....	50
11.6	CONTRACTOR’S EXTRA WORK REPORT .....	51
ARTICLE 12 - CHANGE OF CONTRACT TIMES .....		52
12.1	GENERAL .....	52
12.2	EXTENSIONS OF CONTRACT TIMES FOR DELAY DUE TO WEATHER. 53	
ARTICLE 13 - INSPECTIONS AND TESTS; CORRECTION, REMOVAL OR ACCEPTANCE OF DEFECTIVE WORK .....		53
13.1	NOTICE OF DEFECTIVE WORK .....	53
13.2	ACCESS TO WORK .....	53
13.3	INSPECTIONS AND TESTS.....	53
13.4	CITY MAY STOP THE WORK .....	55
13.5	CORRECTION OR REMOVAL OF DEFECTIVE WORK.....	55
13.6	ACCEPTANCE OF DEFECTIVE WORK .....	55
13.7	CITY MAY CORRECT DEFECTIVE WORK.....	56
13.8	CORRECTION PERIOD.....	56
ARTICLE 14 - PAYMENTS TO CONTRACTOR AND COMPLETION.....		57
14.1	SCHEDULE OF VALUES (LUMP SUM PRICE BREAKDOWN) .....	57
14.2	UNIT PRICE BID SCHEDULE .....	57
14.3	APPLICATION FOR PROGRESS PAYMENT .....	57
14.4	CONTRACTOR’S WARRANTY OF TITLE.....	58
14.5	REVIEW OF APPLICATIONS FOR PROGRESS PAYMENT .....	58
14.6	COMPLETION.....	60
14.7	PARTIAL UTILIZATION.....	61
14.8	FINAL APPLICATION FOR PAYMENT.....	61
14.9	FINAL PAYMENT AND ACCEPTANCE.....	61
ARTICLE 15 - SUSPENSION OF WORK AND TERMINATION .....		63
15.1	SUSPENSION OF WORK BY CITY .....	63
15.2	TERMINATION OF AGREEMENT BY ENGINEER FOR DEFAULT.....	63
15.2	TERMINATION OF AGREEMENT BY CITY FOR CONVENIENCE .....	64
15.4	TERMINATION OF AGREEMENT BY CONTRACTOR.....	64
ARTICLE 16 - GENERAL TERMS .....		65
16.1	GIVING NOTICE.....	65
16.2	TITLE TO MATERIALS FOUND ON THE WORK.....	65
16.3	RIGHT TO AUDIT.....	65
16.4	SURVIVAL OF OBLIGATIONS.....	66
16.5	CONTROLLING LAW .....	66
16.6	SEVERABILITY .....	66
16.7	WAIVER.....	66
ARTICLE 17 - CALIFORNIA STATE REQUIREMENTS.....		67
17.1	STATE WAGE DETERMINATIONS .....	67



17.2	WORKERS' COMPENSATION.....	67
17.3	APPRENTICES ON PUBLIC WORKS.....	67
17.4	WORKING HOURS.....	68
17.5	CONTRACTOR NOT RESPONSIBLE FOR DAMAGE RESULTING FROM CERTAIN ACTS OF GOD.....	68
17.6	NOTICE OF COMPLETION.....	68
17.7	UNPAID CLAIMS.....	68
17.8	RETAINAGE FROM MONTHLY PAYMENTS.....	69
17.9	PUBLIC WORKS CONTRACTS; ASSIGNMENT TO AWARDING BODY...	69
17.10	PAYROLL RECORDS; RETENTION; INSPECTION, NONCOMPLIANCE PENALTIES; RULES AND REGULATIONS.....	70
17.11	CULTURAL RESOURCES.....	71
17.12	PROTECTION OF WORKERS IN TRENCH EXCAVATIONS.....	71
17.13	CONCRETE FORMS, FALSEWORK, AND SHORING.....	72
17.14	REMOVAL, RELOCATION, OR PROTECTION OF EXISTING UTILITIES.	72
17.15	CONTRACTOR LICENSE REQUIREMENTS.....	73
17.16	DIGGING TRENCHES OR EXCAVATIONS; NOTICE ON DISCOVERY OF HAZARDOUS WASTE OR OTHER UNUSUAL CONDITIONS; INVESTIGATIONS; CHANGE ORDERS' EFFECT ON CONTRACT.....	74
17.17	RETENTION PROCEEDS; WITHHOLDING; DISBURSEMENT.....	75
17.18	TIMELY PROGRESS PAYMENTS; INTEREST; PAYMENT REQUESTS ....	77
17.19	PREFERENCE FOR MATERIAL.....	77
17.20	RESOLUTION OF CONSTRUCTION CLAIMS.....	78

## ARTICLE 1 - DEFINITIONS

Whenever used in these General Conditions or in the other Contract Documents, the following terms have the meanings indicated in this Article 1 which meanings are applicable to both the singular and plural thereof. If a word which is entirely in upper case in these definitions is found in lower case in the Contract Documents, then the lower case word will have its ordinary meaning.

**Addenda** - Written or graphic instruments issued prior to the opening of Bids which make additions, deletions, or revisions to the Contract Documents.

**Agreement** - The written contract between the CITY and the CONTRACTOR covering the WORK to be performed; other documents are attached to the Agreement and made a part thereof as provided therein.

**Application for Payment** - The form accepted by the ENGINEER which is to be used by the CONTRACTOR to request progress payments or final payment and which is to be accompanied by such supporting documentations as is required by the Contract Documents.

**Asbestos** - Any material that contains more than one percent asbestos and is friable or is releasing asbestos fibers into the air above current action levels established by the United States Occupational Safety and Health Administration.

**Bid** - The offer or proposal of the bidder submitted on the prescribed form setting forth the price or prices for the WORK.

**Bonds** - Bid, Performance, and Labor and Materials, and Maintenance Bonds and other instruments of security.

**Change Order** - A document recommended by the ENGINEER, which is signed by the CONTRACTOR and the CITY, and authorizes an addition, deletion, or revision in the WORK, or an adjustment in the Contract Price or the Contract Times, issued on or after the Effective Date of the Agreement.

**CITY** - The City of Petaluma.

**Clarification** - A document issued by the ENGINEER to the CONTRACTOR that clarifies the requirements(s) and/or design intent of the Contract Documents, which may not represent an addition, deletion, or revision in the WORK or an adjustment in the Contract Price or the Contract Times.

**Contract Documents** - The Notice Inviting Bids, Instructions to Bidders, Bid Forms (including the Bid, Bid Schedule(s), Information Required of Bidder, Bid Bond, and all required certificates, affidavits and other documentation), Agreement, Performance Bond, Labor and Materials Bond, Maintenance Bond, General Conditions, any Supplementary General

Conditions, Special Provisions, Specifications, Drawings, all Addenda, and Change Orders executed pursuant to the provisions of the Contract Documents. Shop Drawings are not Contract Documents.

**Contract Price** - The total monies payable by the CITY to the CONTRACTOR under the terms and conditions of the Contract Documents.

**Contract Times** - The number or numbers of successive calendar days or dates stated in the Contract Documents for the completion of the WORK.

**CONTRACTOR** - The individual, partnership, corporation, joint-venture, or other legal entity with whom the CITY has executed the Agreement.

**Day** - A calendar day of 24 hours measured from midnight to the next midnight.

**Defective Work** - Work that is unsatisfactory, faulty, or deficient; or that does not conform to the Contract Documents; or that does not meet the requirements of any inspection, reference standard, test, or approval referred to in the Contract Documents; or work that has been damaged prior to the ENGINEER's recommendation of final payment.

**Drawings** - The drawings, plans, maps, profiles, diagrams, and other graphic representations which indicate the character, location, nature, extent, and scope of the WORK and which have been prepared by the ENGINEER and are included and/or referred to in the Contract Documents. Shop Drawings are not Drawings as so defined.

**Effective Date of the Agreement** - The date indicated in the Agreement on which it becomes effective, but if no such date is indicated it means the date which the Agreement is signed and delivered by the last of the two parties to sign and deliver.

**ENGINEER** - The City Manager or his/her designee.

**Field Order** - A written order issued by the ENGINEER which may or may not involve a change in the WORK.

**Hazardous Waste** - The term Hazardous Waste shall have the meaning provided in Section 1004 of the Solid Waste Disposal Act (42 U.S.C. Section 6906) as amended from time to time.

**Laws and Regulations; Laws or Regulations** - Any and all applicable laws, rules, regulations, ordinances, codes, and/or orders of any and all governmental bodies, agencies, authorities and courts having jurisdiction.

**Lien or Mechanic's Lien** - A form of security, an interest in real property, which is held to secure the payment of an obligation. When related to public works construction, Lien or Mechanic's Lien may be called Stop Notice.

**Milestone** - A principal event specified in the Contract Documents relating to an intermediate completion date of a separately identifiable part of the WORK or a period of time within which the separately identifiable part of the WORK should be performed prior to completion of all the WORK.

**Notice of Award** - The written notice by the CITY to the apparent successful bidder stating that upon compliance by the apparent successful bidder with the conditions precedent enumerated therein within the time specified, the CITY will enter into an Agreement.

**Notice of Completion** - A form signed by the ENGINEER and the CONTRACTOR recommending to the CITY that the WORK is Complete and fixing the date of completion. After acceptance of the WORK by the CITY Council, the form is signed by the CITY and filed with the County Recorder. This filing starts the 30 day lien filing period on the WORK.

**Notice to Proceed** - The written notice issued by the CITY to the CONTRACTOR authorizing the CONTRACTOR to proceed with the WORK for the purpose for which it is intended prior to completion of all the WORK.

**Partial Utilization** - Use by the CITY of a completed part of the WORK for the purpose for which it is intended prior to completion of all the WORK.

**Petroleum** - Petroleum, including crude oil or any fraction thereof which is liquid at standard conditions of temperature and pressure (60 degrees Fahrenheit and 14.7 pounds per square inch absolute), such as oil, petroleum, fuel oil, oil sludge, oil refuse, gasoline, kerosene, and oil mixed with other non-Hazardous Wastes and crude oils.

**Project** - The total construction project of which the WORK to be provided under the Contract Documents may be the whole, or as part as indicated elsewhere in the Contract Documents.

**Record Drawings** - Drawings generated by marking a set of Drawings to reflect all of the changes that have occurred during construction of the Project.

**Resident Project Representative** - The authorized representative of the ENGINEER who is assigned to the Site or any part thereof.

**Samples** - Physical examples of materials, equipment, or workmanship that are representative of some portion of the WORK and which establish the standards by which such portion of the WORK will be judged.

**Shop Drawings** - All drawings, diagrams, illustrations, schedules, and other data which are specifically prepared by or for the CONTRACTOR and submitted by the CONTRACTOR to illustrate some portion of WORK.

**Site** - Lands or other areas designated in the Contract Documents as being furnished by the CITY for the performance of the construction, storage, or access.

**Special Provisions** - Specific clauses setting forth conditions or requirements peculiar to the work and supplementary to the Standard Specifications.

**Specifications** - The directions, provisions and requirements set forth in the Standard Specifications as supplemental and modified by the special provisions.

**Stop Notice** - A legal remedy for subcontractors and suppliers who contribute to public works, but who are not paid for their work, which secures payment from construction funds possessed by the CITY. In some states, for public property, the Stop Notice remedy is designed to substitute for a mechanic's lien.

**Subcontractor** - An individual, partnership, corporation, joint-venture, or other legal entity having a direct contract with the CONTRACTOR or with any other subcontractor for the performance of a part of the WORK at the Site.

**Supplementary General Conditions** - The part of the Contract Documents which make additions, deletions, or revisions to these General Conditions.

**Supplier** - A manufacturer, fabricator, distributor, materialman, or vendor having a direct contract with the CONTRACTOR or with any Subcontractor to furnish materials, equipment, or product to be incorporated in the WORK by the CONTRACTOR or any Subcontractor.

**Utilities** - All pipelines, conduits, ducts, cables, wires, tracks, manholes, vaults, tanks, tunnels, or other such facilities or attachments, and any encasements containing such facilities which have been installed underground or above the ground to furnish any of the following services or materials; water, sewage, sludge, drainage, fluids, electricity, gases, steam, liquid petroleum products, telephone or other communications, cable television, traffic control, or other control systems.

**WORK** - The entire completed construction or the various separately identifiable parts thereof required to be furnished under the Contract Documents. WORK is the result of performing or furnishing labor and furnishing and incorporating materials and equipment into the construction, and performing or furnishing services and furnishing documents, all as required by the Contract Documents.

**Working day** - Any day except Saturdays, Sundays and CITY holidays.

## **ARTICLE 2 – PRELIMINARY MATTERS**

### **2.1 DELIVERY OF BONDS AND INSURANCE CERTIFICATES**

- A. When the CONTRACTOR delivers the signed Agreement to the CITY, the CONTRACTOR shall also deliver to the CITY such Bonds and insurance policies and certificates as the CONTRACTOR may be required to furnish in accordance with the Contract Documents.

## 2.2 COPIES OF DOCUMENTS

- A. The CITY will furnish to the CONTRACTOR the required number of copies of the Contract Documents specified in the Supplementary General Conditions.

## 2.3 COMMENCEMENT OF CONTRACT TIMES; NOTICE TO PROCEED

- A. The Contract Times will start to run on the commencement date stated in the Notice to Proceed.

## 2.4 STARTING THE WORK

- A. The CONTRACTOR shall begin to perform the WORK on the commencement date stated in the Notice to Proceed, but no work shall be done at the Site prior to said commencement date.
- B. Before undertaking each part of the WORK, the CONTRACTOR shall review the Contract Documents in accordance with Paragraph 3.3.

## 2.5 PRECONSTRUCTION CONFERENCE

- A. The CONTRACTOR is required to attend a preconstruction conference. This conference will be attended by the CITY, ENGINEER, and others as appropriate in order to discuss the WORK.
- B. The CONTRACTOR's initial schedule submittals for shop drawings, obtaining permits, and Plan of Operation and CPM Schedule will be reviewed and finalized. At a minimum, the CONTRACTOR's representatives shall include its project manager, project superintendent and schedule expert. If the submittals are not finalized at the end of the meeting, additional meetings will be held so that the submittals can be finalized prior to the submittal of the first Application for Payment. No Application for Payment will be processed prior to receiving acceptable initial submittals from the CONTRACTOR.

# ARTICLE 3 – INTENT AND USE OF CONTRACT DOCUMENTS

## 3.1 INTENT

- A. The Contract Documents comprise the entire agreement between the CITY and the CONTRACTOR concerning the WORK. The Contract Documents are complementary; what is called for by one is as binding as if called for by all. The Contract Documents will be construed in accordance with the law of the State of California .
- B. It is the intent of the Contract Documents to describe the WORK, functionally complete, to be constructed in accordance with the Contract Documents. Any

labor, documentation, services, materials, or equipment that may reasonably be inferred from the Contract Documents or from prevailing custom or trade usage as being required to produce the intended result will be provided whether or not called for specifically.

- C. When words or phrases which have a well-known technical or construction industry or trade meaning are used to describe work, materials, or equipment such words or phrases shall be interpreted in accordance with that meaning unless a definition has been provided in Article 1 of the General Conditions.

### 3.2 REFERENCE TO STANDARDS

- A. Reference to standard specifications, manuals, or codes of any technical society, organization, or association, or to the Laws or Regulations of any governmental authority, whether such reference be specific or by implication, shall mean the latest standard specification, manual, code, or Laws or Regulations in effect at the time of opening of Bids, except as may be otherwise specifically stated. However, no provision of any referenced standard specification, manual or code shall be effective to change the duties and responsibilities of the CITY or the CONTRACTOR or any of their consultants, agents or employees, from those set forth in the CONTRACT Documents, nor shall it be effective to assign to CITY any duty or authority to direct the performance of the WORK or any duty or authority to undertake responsibility inconsistent with the provisions of the Contract Documents.

### 3.3 REVIEW OF CONTRACT DOCUMENTS

- A. If, during the performance of the WORK, CONTRACTOR discovers any conflict, error, ambiguity or discrepancy within the Contract Documents or between the Contract Documents and any provision of any such Law or Regulation applicable to the performance of the WORK or of any such standard, specification, manual, or code, or of any instruction of any Supplier, CONTRACTOR shall report it to ENGINEER in writing at once, and CONTRACTOR shall not proceed with the work affected thereby (except in an emergency as authorized by Paragraph 6.13 until a Clarification, Field Order, or Change Order to the Contract Documents has been issued.

### 3.4 ORDER OF PRECEDENCE OF CONTRACT DOCUMENTS

A. Unless otherwise noted herein, conflicts or inconsistencies between parts of the Contract will be resolved by the ENGINEER with a Change Order or an Addendum, if required. Addenda and Change Orders bearing the most recent date shall prevail over Addenda or Change Orders bearing earlier dates. Any reference to addenda-changed specifications or drawings shall be considered to have been changed accordingly. In resolving conflicts resulting from errors or discrepancies in any of the Contract Documents, the order of precedence shall be as follows:

1. Change Orders/Addenda (most recent in time take precedence)
2. Agreement and Bond Forms
3. Referenced Standard Specifications
4. Special Provisions
5. Drawings
6. General Conditions
7. Instructions to Bidders
8. Contractor's Bid (Bid Form)
9. Notice Inviting Bids
10. Supplementary General Conditions (if any)
11. Permits from other agencies as may be required by law

B. With reference to the Drawings the order of precedence is as follows:

1. Figures govern over scaled dimensions
2. Detail drawings govern over general drawings
3. Addenda/Change Order drawings govern over any other drawings
4. Drawings govern over standard drawings

### 3.5 AMENDING CONTRACT DOCUMENTS

A. The Contract Documents may be amended to provide for additions, deletions, and revisions in the WORK or to modify the terms and conditions thereof by a Change Order (pursuant to Article 10).

### 3.6 REUSE OF DOCUMENTS

A. Neither the CONTRACTOR, nor any Subcontractor or Supplier, nor any other person or organization performing any of the WORK under a contract with the CITY shall have or acquire any title to or ownership rights in any of the Drawings, Technical Specifications, or other documents used on the WORK, and they shall not reuse any of them on the extensions of the Project or any other project without written consent of CITY.



## ARTICLE 4 – SITE OF THE WORK

### 4.1 AVAILABILITY OF LANDS

- A. The CITY will furnish, as indicated in the Contract Documents, the lands upon which the WORK is to be performed, rights-of-way and easements for access thereto, and such other lands which are designated for the use of the CONTRACTOR. Easements for permanent structures or permanent changes in existing facilities will be obtained and paid for by the CITY, unless otherwise provided in the Contract Documents. Nothing contained in the Contract Documents shall be interpreted as giving the CONTRACTOR exclusive occupancy of the lands or rights-of-way provided. The CONTRACTOR shall provide for all additional lands and access thereto that may be required for temporary construction facilities or storage of materials and equipment; provided, that the CONTRACTOR shall not enter upon nor use any property not under the control of the CITY until a written temporary construction easement agreement has been executed by the CONTRACTOR and the property owner, and a copy of said easement furnished to the ENGINEER prior to said use; and the CITY will not be liable for any claims or damages resulting from the CONTRACTOR's trespass on or use of any such properties. The CONTRACTOR shall provide the CITY with a signed release from the property owner confirming that the lands have been satisfactorily restored upon completion of the WORK.

### 4.2 REPORTS OF PHYSICAL CONDITIONS

- A. **Subsurface Explorations:** Reference is made to any Supplementary General Conditions for identification of those reports of explorations and tests of subsurface conditions at the Site that have been utilized by the ENGINEER in the preparation of the Contract Documents.
- B. **Existing Structures:** Reference is made to any Supplementary General Conditions for identification of those drawings of physical conditions in or relating to existing surface and subsurface structures (except underground Utilities referred to in Paragraph 4.3 herein) which are at or contiguous to the Site that have been utilized in the preparation of the Contract Documents.
- C. The CITY makes no representation as to the completeness of the reports or drawings referred to in Paragraph 4.2 A or B above or the accuracy of any data or information contained therein. The CONTRACTOR may rely upon the accuracy of the technical data contained in such reports and drawings. However, the CONTRACTOR may not rely upon any interpretation of such technical data, including any interpolation or extrapolation thereof, or any non-technical data, interpretations, and opinions contained therein.

#### 4.3 PHYSICAL CONDITIONS - UNDERGROUND UTILITIES

- A. **Indicated:** The information and data indicated in the Contract Documents with respect to existing underground Utilities at or contiguous to the Site are based on information and data furnished to the CITY or the ENGINEER by the owners of such underground Utilities or by others. Unless it is expressly provided in any Supplementary General Conditions the CITY will not be responsible for the accuracy or completeness of any such information or data, and the CONTRACTOR shall have full responsibility for reviewing and checking all such information and data, for locating all underground Utilities indicated in the Contract Documents, for coordination of the WORK with the owners of such underground Utilities during construction, for the safety and protection thereof and repairing any damage thereto resulting from the WORK, the cost of all of which are deemed to have been included in the Contract Price.
- B. **Not Indicated:** If an underground Utility is uncovered or revealed at or contiguous to the Site which was not indicated in the Contract Documents and which the CONTRACTOR could not reasonably have been expected to be aware of, the CONTRACTOR shall identify the owner of such underground Utility and give written notice thereof to that owner and shall notify the ENGINEER.

#### 4.4 DIFFERING SITE CONDITIONS

- A. The CONTRACTOR shall notify the ENGINEER, in writing, of the following unforeseen conditions, hereinafter called differing Site conditions, promptly upon their discovery (but in no event later than 14 days after their discovery) and before they are disturbed:
  - 1. Subsurface or latent physical conditions at the Site of the WORK differing materially from those indicated, described, or delineated in the Contract Documents, including those reports discussed in Paragraph 4.2, 4.3, and 4.5.
- B. The ENGINEER will review the pertinent conditions, determine the necessity of obtaining additional explorations or tests with respect thereto.
- C. If the ENGINEER concludes that because of newly discovered conditions a change in the Contract Documents is required, a Change Order will be issued as provided in Article 10 to reflect and document the consequences of the difference.
- D. In each such case, an increase or decrease in the Contract Price or an extension or shortening the Contract Times, or any combination thereof, will be allowable to the extent that they are attributable to any such difference. If the ENGINEER and the CONTRACTOR are unable to agree as to the amount or length thereof, a claim may be made therefor as provided in Articles 11 and 12.

- E. The CONTRACTOR's failure to give notice of differing Site conditions within 14 days of their discovery and before they are disturbed shall constitute a waiver of all claims in connection therewith, whether direct or consequential in nature.

#### 4.5 HAZARDOUS MATERIALS

- A. CITY shall be responsible for any Asbestos, Hazardous Waste, Petroleum, or Radioactive Material uncovered or revealed at the Site which was not shown or indicated in Drawings or Specifications or identified in the Contract Documents to be within the scope of the WORK and which may present a substantial danger to persons or property exposed thereto in connection with the WORK at the Site. CITY will not be responsible for any such material brought to the Site by CONTRACTOR, Subcontractors, Suppliers, or anyone else for whom CONTRACTOR is responsible.
  - 1. Upon discovery of any Asbestos, Hazardous Waste, Petroleum, or Radioactive Material, the CONTRACTOR shall immediately stop all work in any area affected thereby (except in an emergency as required by Paragraph 6.13) and notify ENGINEER (and therefore confirm such notice in writing). CONTRACTOR shall not be required to resume any work in any such affected area until after CITY has obtained any required permits related thereto and delivered to CONTRACTOR special written notice. Such written notice will specify that such condition and any affected area is or has been rendered safe for the resumption of the work or specify any special conditions under which the work may be resumed safely. If ENGINEER and CONTRACTOR cannot agree as to entitlement to or the amount or extent of adjustment, if any, in Contract Price or Contract Times as a result of such work stoppage or such special conditions under which work is agreed by CONTRACTOR to be resumed, either party may make a claim therefor as provided in Articles 11 and 12.
  - 2. If, after receipt of such special written notice, CONTRACTOR does not agree to resume such WORK based on a reasonable belief it is unsafe, or does not agree to resume such WORK under special conditions, ENGINEER may order such portion of the WORK that is in connection with such hazardous condition or in such affected area to be deleted from the WORK. If ENGINEER and CONTRACTOR cannot agree as to entitlement to or the amount or extent of an adjustment, if any, in Contract Price or Contract Times as a result of deleting such portion of the WORK then either party may make a claim therefor as provided in Articles 11 and 12. CITY may have such deleted portion of the WORK performed by CITY's own forces or others in accordance with Article 7.
- B. The provisions of Paragraphs 4.2, 4.3, and 4.4 are not intended to apply to Asbestos, Petroleum, Hazardous Waste, or Radioactive Material uncovered or revealed at the Site.

#### 4.6 REFERENCE POINTS

- A. The ENGINEER will provide the location and elevation of one bench mark, near or on the Site of the WORK, for use by the CONTRACTOR for alignment and elevation control. Unless otherwise specified in any Supplementary General Conditions, the CONTRACTOR shall furnish all other lines, grades, and bench marks required for proper execution of the WORK.
- B. The CONTRACTOR shall preserve or replace any and all bench marks, section corners, witness corners, stakes, and other survey marks, and in case of their removal or destruction by any party, the CONTRACTOR shall be responsible for the accurate replacement of such reference points by surveyor licensed under the applicable state codes governing land surveyors.

### ARTICLE 5 – BONDS AND INSURANCE

#### 5.1 BONDS

- A. The CONTRACTOR shall furnish Performance and Labor and Materials Bonds, each in the amount of one hundred percent (100%) of the contract price, as security for the faithful performance and payment of all the CONTRACTOR's obligations under the Contract Documents. These Bonds shall remain in effect at least until one year after the date of completion, except as otherwise provided by Law or Regulation or by the Contract Documents. The CONTRACTOR shall also furnish such other Bonds as are required by the Supplementary General Conditions.
- B. The CONTRACTOR shall guarantee the WORK to be free of defects in material and workmanship for a period of one (1) year following the CITY's acceptance of the WORK. The CONTRACTOR shall agree to make, at the CONTRACTOR's own expense, any repairs or replacements made necessary by defects in material or workmanship which become evident within the one-year guarantee period. The CONTRACTOR's guarantee against defects required by this provision shall be secured by a Maintenance Bond, in the amount of ten percent (10%) of the contract price, which shall be delivered by the CONTRACTOR to the CITY prior to acceptance of the WORK. The Maintenance Bond shall remain in force for one (1) year from the date of acceptance of the contracted WORK. The CONTRACTOR shall make all repairs and replacements within the time required during the guarantee period upon receipt of written order from the ENGINEER. If the CONTRACTOR fails to make the repairs and replacements within the required time, the CITY may do the work and the CONTRACTOR and the CONTRACTOR's surety for the Maintenance Bond shall be liable to the CITY for the cost. The expiration of the Maintenance Bond during the one-year guarantee period does not operate to waive or void the one-year guarantee, as set forth herein and in paragraph 6.16 of these General Conditions.

- C. All Bonds shall be in the form prescribed by the Contract Documents except as provided otherwise by Laws or Regulations, and shall be executed by such sureties as are named in the current list of “Companies Holding Certificates of Authority as Acceptable Sureties on Federal bonds and as Acceptable Reinsuring Companies” as published in Circular 570 (amended) by the Audit Staff, Bureau of Government Financial Operations, U.S. Treasury Department. All Bonds signed by an agent must be accompanied by a certified copy of such agent’s authority to act.
- D. If the surety on any Bond furnished by the CONTRACTOR is declared a bankrupt or becomes insolvent or its right to do business is terminated in any state where any part of the WORK is located, the CONTRACTOR shall within 7 days thereafter substitute another Bond and surety, which must be acceptable to the CITY.
- E. All Bonds required by the Contract Documents to be purchased and maintained by CONTRACTOR shall be obtained from surety companies that are duly licensed or authorized in the State of California to issue Bonds for the limits so required. Such surety companies shall also meet such additional requirements and qualifications as may be provided in the Supplementary General Conditions.

## 5.2 INSURANCE

Contractor and any subcontractor shall not commence work under this Agreement until Contractor shall have obtained all insurance required under this paragraph and such insurance shall have been approved by the City Attorney as to form and carrier and the City Manager as to sufficiency, nor shall Contractor allow any contractor or subcontractor to commence work on this contract or subcontract until all similar insurance required of the contractor and/or subcontractor shall have been so obtained and approved. All requirements herein provided shall appear either in the body of the insurance policies or as endorsements and shall specifically bind the insurance carrier.

CONTRACTOR shall procure and maintain for the duration of the contract all necessary insurance against claims for injuries to persons or damages to property which may arise from or in connection with the performance of the work hereunder by the Contractor, the Contractor’s agents, representatives, employees or subcontractors.

**A. Minimum Scope of Insurance**

Coverage shall be at least as broad as:

1. Insurance Services Office Commercial General Liability coverage.
2. Insurance Services Office form number CA covering Automobile Liability, code 1 (any auto).
3. Workers' Compensation insurance as required by the State of California and Employer's Liability Insurance.
4. [Optional] Such other insurance coverages and limits as may be required by the CITY as follows: \_\_\_\_\_.

**B. Minimum Limits of Insurance**

CONTRACTOR shall maintain limits no less than:

1. General Liability: \$2,000,000 per occurrence for bodily injury, personal injury and property damage. If Commercial General Liability Insurance or other form with a general aggregate liability is used, either the general aggregate limit shall apply separately to this project/location or the general aggregate limit shall be twice the required occurrence limit.
2. Automobile Liability: \$1,000,000 per accident for bodily injury and property damage.
3. Employer's Liability: Bodily Injury by Accident - \$1,000,000 each accident  
Bodily Injury by Disease - \$1,000,000 policy limit  
Bodily Injury by Disease - \$1,000,000 each employee

**C. Deductibles and Self-Insured Retentions**

Any deductibles or self-insured retentions must be declared to and approved by the CITY. At the option of the CITY, either: the insurer shall reduce or eliminate such deductibles or self-insured retentions as respects the CITY, its officers, officials, employees, and volunteers; or the CONTRACTOR shall procure a bond guaranteeing payment of losses and related investigations, claim administration and defense expenses.

**D. Other Insurance Provisions**

The required general liability and automobile policies are to contain, or be endorsed to contain the following provisions:

1. The CITY, its officers, officials, employees, agents and volunteers are to be covered as insureds as respects: liability arising out of activities performed by or on behalf of the CONTRACTOR; products and completed operations of the CONTRACTOR; premises owned, occupied or used by the CONTRACTOR; or automobiles owned, leased, hired or borrowed by the CONTRACTOR. The coverage shall contain no special limitations on the scope of protection afforded to the CITY, its officers, officials, employees, agents or volunteers.
2. For any claims related to this project, the CONTRACTOR's insurance coverage shall be primary insurance as respects the CITY, its officers, officials, employees, agents and volunteers. Any insurance or self-insurance maintained by the CITY, its officers, officials, employees, agents or volunteers shall be excess of the CONTRACTOR's insurance and shall not contribute with it.
3. Any failure to comply with reporting or other provisions of the policies including breaches of warranties shall not affect coverage provided to the CITY, its officers, officials, employees, agents or volunteers.
4. The CONTRACTOR's insurance shall apply separately to each insured against whom claim is made or suit is brought except, with respect to the limits of the insurer's liability.
5. Each insurance policy required by this clause shall be endorsed to state that coverage shall not be suspended, voided, canceled by either party, reduced in coverage or in limits except after thirty (30) days' prior written notice by certified mail, return receipt requested, has been given to the CITY.

**E. Acceptability of Insurers**

Insurance is to be placed with insurers with a current A.M. Best's rating of no less than A:VII.

**F. Verification of Coverage**

CONTRACTOR shall furnish the CITY with original endorsements effecting coverage required by this clause. The endorsements are to be signed by a person authorized by that insurer to bind coverage on its behalf. The endorsements are to be on forms provided by the CITY. All endorsements are to be received and

approved by the CITY before work commences. As an alternative to the CITY's forms, the CONTRACTOR's insurer may provide complete, certified copies of all required insurance policies, including endorsements effecting the coverage required by these specifications.

## **ARTICLE 6 – CONTRACTOR'S RESPONSIBILITIES**

### **6.1 COMMUNICATIONS**

- A. Written communications with the CITY shall be only through or as directed by the ENGINEER.

### **6.2 SUPERVISION AND SUPERINTENDENCE**

- A. The CONTRACTOR shall supervise, inspect, and direct the WORK competently and efficiently, devoting such attention thereto and applying such skills and expertise as may be necessary to perform the WORK in accordance with the Contract Documents. The CONTRACTOR shall be solely responsible for the means, methods, techniques, sequences, and procedures of construction and all safety precautions and programs incidental thereto. The CONTRACTOR shall be responsible to see that the completed WORK complies accurately with the Contract Documents.
- B. The CONTRACTOR shall designate in writing and keep on the Site at all times during the performance of the WORK a technically qualified, English-speaking superintendent, who is an employee of the CONTRACTOR and who shall not be replaced without written notice to the ENGINEER. The superintendent will be the CONTRACTOR's representative at the Site and shall have authority to act on behalf of the CONTRACTOR. All communications given to the superintendent shall be as binding as if given to the CONTRACTOR.
- C. The CONTRACTOR's superintendent shall be present at the Site at all times while work is in progress and shall be available by phone for emergencies 24 hours per day, 7 days per week. Failure to observe this requirement shall be considered suspension of the WORK by the CONTRACTOR until such time as such superintendent is again present at the Site.

### **6.3 LABOR, MATERIALS, AND EQUIPMENT**

- A. The CONTRACTOR shall provide competent, suitably qualified personnel to survey and lay out the WORK and perform construction as required by the Contract Documents. The CONTRACTOR shall furnish, erect, maintain, and remove the construction plant and any required temporary works. The CONTRACTOR shall at all times maintain good discipline and order at the Site. Except in connection with the safety or protection of persons or the WORK or property at the Site or adjacent thereto, and except as otherwise indicated in the



Contract Documents, all work at the Site shall be performed during regular working hours, and the CONTRACTOR will not permit overtime work or the performance of work on Saturday, Sunday, or any federally observed holiday without the CITY's written consent. The CONTRACTOR shall apply for this consent through the ENGINEER in writing a minimum of 24 hours in advance.

- B. Except as otherwise provided in this Paragraph, the CONTRACTOR shall receive no additional compensation for overtime work, i.e., work in excess of 8 hours in any one calendar day or hours in any one calendar week, even though such overtime work may be required under emergency conditions and may be ordered by the ENGINEER in writing. Additional compensation will be paid to the CONTRACTOR for overtime work only in the event extra work is ordered by the ENGINEER and the Change Order specifically authorizes the use of overtime work and then only to such extent as overtime wages are regularly being paid by the CONTRACTOR for overtime work of a similar nature in the same locality.
- C. All increased costs of inspection and testing performed during overtime work by the CONTRACTOR which is allowed solely for the convenience of the CONTRACTOR shall be borne by the CONTRACTOR. The CITY has the authority to deduct the cost of all such inspection and testing from any partial payments otherwise due to the CONTRACTOR.
- D. Unless otherwise specified in the Contract Documents, the CONTRACTOR shall furnish and assume full responsibility for all materials, equipment, labor, transportation, construction equipment and machinery, tools, appliances, fuel, lubricants, power, light, heat, telephone, water, sanitary facilities, and all other facilities, consumables, and incidentals necessary for the furnishing, performance, testing, start-up, and completion of the WORK.
- E. All materials and equipment incorporated into the WORK shall be of specified quality and new, except as otherwise provided in the Contract Documents. All warranties and guarantees specifically called for by the Specifications shall expressly run to the benefit of the CITY. If required by the ENGINEER, the CONTRACTOR shall furnish satisfactory evidence (including reports of required tests) as to the source, kind and quality of materials and equipment. All materials and equipment shall be stored, applied, installed, connected, erected, protected, used, cleaned, and conditioned in accordance with the instructions of the applicable Supplier except as otherwise provided in the Contract Documents; but no provisions of any such instructions will be effective to assign to the CITY or any of its consultants, agents, or employees, any duty or authority to supervise or direct the furnishing or performance of the WORK or any duty or authority to undertake responsibility contrary to the provisions of Paragraph 9.9 C.
- F. The work, unless otherwise permitted or approved by the ENGINEER, shall be completed with the incorporated use of equipment, materials, and/or products where such are specified. Substitutions and equal alternatives will be permitted as

provided in this article; however, neither the request for substitution nor the offer of alternatives shall in any way by their submittal obligate the CITY to assent to any request or offer. Failure of the CONTRACTOR awarded the work to either submit requests for substitutions or to offer alternatives within the required times provided in this General Condition will be considered as evidence that the work shall be accomplished with trade-named equipment, materials, and/or products as identified in the Specifications and/or the Drawings.

- G. Unless otherwise provided elsewhere in the Contract, all equipment, materials, and/or products incorporated into the work shall be new and, where not specified, shall be of the highest quality of the respective kinds for the intended use, and all workmanship shall meet or exceed applicable construction industry standards and practices. If equipment, materials, and/or products are designated by listing named manufacturers of particular equipment, materials, and/or products followed by the words "or equal," then the CONTRACTOR may furnish the named equipment, materials, and/or products or any equal equipment, materials, and/or products. The first-named manufacturer of particular equipment, materials, and/or products is the basis for the design shown on the Project Drawings. A subsequently named manufacturer or particular equipment, materials, and/or products has been determined to be an acceptable substitution but may require modifications in the Project's design and its ultimate construction to accommodate its use. If such subsequently named items are selected by the CONTRACTOR for incorporation into the work, the CONTRACTOR shall assume all costs required for modifications to the equipment, materials, and/or products, and Project design and construction as may be required for said items' use. Substitutions for an unnamed "equal" item of material shall be permitted upon compliance of the procedures set forth in Paragraph I of this article. If a CONTRACTOR makes use of an unnamed "equal" product as a substitute for a specifically named material or product, the CONTRACTOR shall assume all costs required to make the necessary revisions or modifications to accommodate the use of said unnamed product.
- H. Before beginning the work and within thirty-five (35) calendar days after award of the Contract, the CONTRACTOR shall submit a List of Materials to the ENGINEER for review. The List shall include all items of equipment, materials, and/or products to be incorporated into the work and the names of suppliers with whom purchase orders have been placed. The names on the List shall be arranged in the same order as in the specifications, and shall contain sufficient data to identify precisely the items of equipment, materials, and/or products the CONTRACTOR proposes to furnish. The List shall include Specifications or Drawing references. Once the submission is determined to be acceptable to the ENGINEER, it shall be returned to the CONTRACTOR.
- I. Substitution for those equipment, materials, and/or products specified shall only be permitted when the proposed unnamed "equal" product or material to be furnished is both equal in quality and utility and after the CONTRACTOR has

complied with the following provisions: (1) All substitutions shall be reviewed by the ENGINEER. (2) The ENGINEER must approve such substitution in writing prior to its incorporation into the work. (3) Unless otherwise authorized in writing by the CITY, the CONTRACTOR shall, within thirty-five (35) calendar days of award and prior to placing any purchase orders, but at least thirty (30) calendar days before it requires approval of any such alternative item, submit to the CITY sufficient data, drawings, samples, literature, or other detailed information as will demonstrate to the ENGINEER that the proposed substitute is equal in quality and utility to the equipment, materials and/or products specified.

1. Within thirty (30) calendar days following receipt of all requested information from the CONTRACTOR, the ENGINEER will determine whether the proposed alternative is equal in quality and utility and meets the requirements of the Contract and will inform the CONTRACTOR in writing of such determination. The burden of substantiating the quality and utility of alternatives shall be upon the CONTRACTOR, and the CONTRACTOR shall furnish all necessary information requested and required by the ENGINEER. The ENGINEER will be the sole judge as to the quality and utility of alternative equipment, materials, and/or products, and the ENGINEER's decision shall be final. An acceptance by the ENGINEER of a substitution shall not relieve the CONTRACTOR from complying with the requirements of the Drawings and Specifications. Acceptance by the ENGINEER shall not relieve the CONTRACTOR from full responsibility for the efficiency, sufficiency, and quality and performance of the substitute equipment, materials, and/or products, in the same manner and degree as the equipment, materials, and/or products specified by name.
2. Failure of the CONTRACTOR to submit proposed substitutions for review in the manner described above and within the time prescribed shall be sufficient cause for rejection by the CITY of any other proposed substitutions.
3. In determining whether a proposed product is equal in quality and utility, the ENGINEER is not restricted to such basic issues as performance and durability, but may consider any other issues that the ENGINEER, in the discretion of the ENGINEER, deems appropriate. Said issues may, but are not required to include, nor are they limited to, such additional factors as comparable performance, reliability, efficiency of operation, ease of operation, adaptability, ease of maintenance, capital costs, life-cycle costs, operational characteristics, costs of training personnel, maintenance history, warranties, problems created by the resulting overall warranty system, availability of qualified service, availability of parts, the history of any supplier and compatibility with existing facilities.

4. No one factor or group of factors, including such issues as savings on capital costs, shall be determinative of whether the proposed product or material is equal in quality and utility. The decision of the ENGINEER shall be based on those factors deemed by the ENGINEER to be relevant and any data, drawings, samples, literature, or other detailed information furnished by the CONTRACTOR with respect to the proposed substitution. Each decision as to whether a product or material is equal in quality and utility shall be made by the ENGINEER on a case-by-case basis.
  5. The CONTRACTOR shall be responsible for any and all costs, including consultant costs, incurred by the CITY with respect to the proposed substitution that exceed the costs inherent in the normal and reasonable review of drawings and other standard data, information, and documents concerning any proposed substitution. The CONTRACTOR shall be responsible for this cost, regardless of whether or not the substitution is approved by the ENGINEER.
- J. Unless otherwise provided in the Contract, the title and interest in the right to the use of all water, and the title to all soil, stone, gravel, sand, minerals, timber, and all other materials developed or obtained within the Project limits from operations by the CONTRACTOR or any of its subcontractors, of any of their representatives or employees, and the right to use or dispose of the same are hereby expressly reserved in the CITY; and neither the CONTRACTOR nor any of its subcontractors, nor any of their representatives or employees, shall have any right, title, or interest in or to any part thereof.
- K. All material used under the Contract after it has been attached or affixed to the work or soil and after partial payment has been made therefore shall become the property of the CITY.
- L. In the event that any Indian relics or items possessing archaeological or historical value are discovered by the CONTRACTOR or any of its subcontractors or any of their representatives or employees, the CONTRACTOR shall immediately notify the ENGINEER and await the ENGINEER's decision before proceeding with any work. The CONTRACTOR shall have no property right in such relics and items.
- M. The CONTRACTOR shall be satisfied as to the quantity of acceptable materials or products which may be produced or obtained at local sources, and the CITY will not assume any responsibility as to the quantities or quality of acceptable materials or products available.
- N. The CONTRACTOR, with the permission of the ENGINEER, may use in the proposed construction such stone, gravel, sand, or other material suitable in the opinion of the ENGINEER as may be found in excavation.

- O. Existing equipment, materials, and/or products to be salvaged shall remain the property of the CITY. Salvage to be reinstalled in the work shall be refurbished as required before reinstallation. Other work to be salvaged shall be carefully removed and handled in such a manner as to avoid damage and shall be delivered to storage at a location designated by the ENGINEER.

#### 6.4 SCHEDULE

- A. The CONTRACTOR shall comply with the schedule requirements in the Special Provisions or as otherwise provided in the Contract Documents.

#### 6.5 SUBSTITUTES OR “OR EQUAL” ITEMS

- A. The CONTRACTOR shall submit proposed substitutes or “or equal” items in accordance with the Bidding Requirements. No request for substitution of an “or equal” item will be considered by the ENGINEER after award of the Contract, except as provided in Paragraph 6.3I herein.

#### 6.6 CONCERNING SUBCONTRACTORS, SUPPLIERS, AND OTHERS

- A. The CONTRACTOR shall be responsible to the CITY for the acts and omissions of its Subcontractors, Suppliers, and their employees to the same extent as CONTRACTOR is responsible for the acts and omissions of its own employees. Nothing contained in this Paragraph shall create any contractual relationship between any Subcontractor and the CITY nor relieve the CONTRACTOR of any liability or obligation under the Contract Documents. The CONTRACTOR shall include these General Conditions and the Supplementary General Conditions as part of all its subcontract and supply agreements.

#### 6.7 PERMITS

- A. Unless otherwise provided in any Supplementary General Conditions, the CONTRACTOR shall obtain and pay for all construction permits and licenses from the agencies having jurisdiction, including the furnishing of insurance and bonds if required by such agencies. The enforcement of such requirements shall not be made the basis for claims for additional compensation by CONTRACTOR. When necessary, the CITY will assist the CONTRACTOR, in obtaining such permits and licenses. The CONTRACTOR shall pay all charges of utility owners for inspection or connections to the WORK.

#### 6.8 PATENT FEES AND ROYALTIES

- A. The CONTRACTOR shall pay all license fees and royalties and assume all costs incident to the use in the performance of the WORK or the incorporation in the WORK of any invention, design, process, product, or device which is the subject of patent rights or copyrights held by others. If a particular invention, design,

process, product, or device is specified in the Contract Documents for use in the performance of the WORK and if to the actual knowledge of the ENGINEER its use is subject to patent rights or copyrights calling for the payment of any license fee or royalty to others, the existence of such rights will be disclosed by the ENGINEER in the Contract Documents. The CONTRACTOR's indemnification obligation under this Paragraph 6.8 A. for all claims and liabilities arising out of any infringement of patent rights or copyrights incident to the use in the performance of the WORK or resulting from the incorporation in the WORK of any invention, design, process, product or device not specified in the Contract Documents shall be in accordance with Paragraph 6.16 of these General Conditions.

## 6.9 LAWS AND REGULATIONS

- A. The CONTRACTOR shall observe and comply with all Laws and Regulations which in any manner affect those engaged or employed on the WORK, the materials used in the WORK, or the conduct of the WORK including, but not limited to, all applicable safety Laws and Regulations. If any discrepancy or inconsistency should be discovered between the Contract Documents and any such Laws or Regulations, the CONTRACTOR shall report the same in writing to the ENGINEER. Any particular Law or Regulation specified or referred to elsewhere in the Contract Documents shall not in any way limit the obligation of the CONTRACTOR to comply with all other provisions of federal, state, and local laws and regulations. The CONTRACTOR's indemnification obligations for all claims or liability arising from violation of any such law, ordinance, code, order, or regulation, whether by CONTRACTOR or by its employees, Subcontractors or Suppliers shall be in accordance with Paragraph 6.16 of these General Conditions.

## 6.10 TAXES

- A. The CONTRACTOR shall pay all sales, consumer, use, and other similar taxes required to be paid by the CONTRACTOR in accordance with the laws and regulations of the place of the Project which are applicable during the performance of the WORK.

## 6.11 USE OF PREMISES

- A. The CONTRACTOR shall confine construction equipment, the storage of materials and equipment, and the operations of workers to the Site, the land and areas identified in and permitted by the Contract Documents, and the other land and areas permitted by Laws and Regulations, rights-of-way, permits, and easements. The CONTRACTOR shall assume full liability and responsibility for any damage to any such land or area, or to the owner or occupant thereof or of any land or areas contiguous thereto, resulting from the performance of the WORK. Should any claim be made against the CITY by any such owner or occupant because of the performance of the WORK, the CONTRACTOR shall

promptly attempt to settle with such other party by agreement or otherwise resolve the claim through litigation at the CONTRACTOR's sole liability expense. The CONTRACTOR's indemnification obligations for all claims and liability, arising directly, indirectly, or consequentially out of any action, legal or equitable, brought by any such owner or occupant against the CITY, its consultants, subconsultants, and the officers, directors, employees and agents of each and any of them to the extent caused by or based upon the CONTRACTOR's performance of the WORK shall be in accordance with Paragraph 6.16 of these General Conditions.

## 6.12 SAFETY AND PROTECTION

- A. The CONTRACTOR shall be solely responsible for initiating, maintaining, and supervising all safety precautions and programs in connection with the WORK. The CONTRACTOR shall be responsible for the direction and control of the work assigned and for assuring that all workers on the project understand the hazards of the work involved and the safe work procedures required for each job. The CONTRACTOR shall assure that its subcontractors of all tiers shall, without expense to the CITY, comply with this safety responsibility. No work shall proceed until each worker and subcontractor understands the scope of the work and all safety rules and work procedures to be followed. The CONTRACTOR shall not allow a new employee or new subcontractor to begin work on CITY projects without a full and proper safety orientation. The CONTRACTOR shall take all necessary precautions for the safety of, and shall provide the necessary protection to prevent damage to prevent damage, injury or loss to:
1. All persons at the Site and other persons and organizations who may be affected thereby;
  2. All the WORK and materials and equipment to be incorporated therein, whether in storage on or off the Site; and
  3. Other property at the Site or adjacent thereto, including trees, shrubs, lawns, walks, pavements, roadways, structures, and utilities not designated for removal, relocation, or replacement in the course of the performance of the WORK.
- B. The CONTRACTOR shall comply with all applicable Laws and Regulations relating to the safety of persons or property or to the protection of persons or property from damage, injury, or loss and shall erect and maintain all necessary safeguards for such safety and protection. The CONTRACTOR shall notify owners of adjacent property and utilities when prosecution of the WORK may effect them, and shall cooperate with them in the protection, removal, relocation, and replacement of their property. CONTRACTOR'S duties and responsibilities for safety and for protection of the WORK shall continue until such time as all the

WORK is completed and ENGINEER has issued a notice to the CONTRACTOR in accordance with Paragraph 14.7 B. that the WORK is acceptable.

- C. The CONTRACTOR shall designate a qualified and experienced safety representative at the Site whose duties and responsibilities shall be the prevention of accidents and the maintaining and supervising of safety precautions and programs.
- D. Materials that contain hazardous substances or mixtures may be required on the WORK. A Material Safety Data Sheet shall be made available at the Site by the CONTRACTOR for every hazardous product used.
- E. Material usage shall strictly conform to OSHA safety requirements and all manufacturer's warnings and application instructions listed on the Material Safety Data Sheet and on the product container label.
- F. The CONTRACTOR shall be responsible for the exchange of material safety data sheets or other hazard communication information required to be made available to or exchanged between or among employers at the Site in accordance with Laws or Regulations.
- G. The CONTRACTOR shall notify the ENGINEER if it considers a specified product or its intended use to be unsafe. This notification must be given to the ENGINEER prior to the product being ordered, or if provided by some other party, prior to the product being incorporated in the WORK.
- H. Before starting work, the CONTRACTOR shall submit a written safety program to the CITY. The objective of the safety program shall be accident prevention. Such program shall include, but not be limited to, the following:
  - 1. An organization chart and accompanying narrative which describes the responsibility for employee and public safety of those individuals who control each phase of operations and set forth in writing the policies and procedures to be followed by all personnel. The chart shall also show the CONTRACTOR's internal lines of communication (including subcontractors) for the program.
  - 2. A specific program for communication between the CONTRACTOR and CITY on safety matters. The CONTRACTOR shall also designate one person with whom official contact can be made by the CITY on safety matters.
  - 3. Evidence that the CONTRACTOR has become thoroughly familiar with the potential hazards of the work and applicable federal and state regulations.



4. Specific safety procedures and guidelines for conduct of the Work.
5. The CITY's review, comment upon, and/or acceptance of the CONTRACTOR's safety program and/or plan does not in any way negate the responsibilities of the CONTRACTOR for safety or place any responsibility upon the CITY for such safety. Such review comment and/or acceptance shall not be construed as limiting in any manner the CONTRACTOR's obligation to undertake any action which may be necessary or required to establish and maintain safe working conditions at the site.

#### 6.13 EMERGENCIES

- A. In emergencies affecting the safety or protection of persons or the WORK or property at the Site or adjacent thereto, CONTRACTOR, without special instruction or authorization from ENGINEER, is obligated to immediately act to prevent threatened damage, injury, or loss. CONTRACTOR shall give ENGINEER prompt written notice if CONTRACTOR believes that any significant changes in the WORK or variations from the Contract Documents have been caused thereby. If ENGINEER determines that a change in the Contract Documents have been caused thereby. If ENGINEER determines that a change in the Contract Documents is required because of the action taken by CONTRACTOR in response to such an emergency, a Change Order will be issued to document the consequences of such action.

#### 6.14 SUBMITTALS

- A. After checking and verifying all field measurements and after complying with applicable procedures specified in the Special Provisions, the CONTRACTOR shall submit to the ENGINEER for review all Shop Drawings and details of all structural and reinforcing steel, equipment, electrical controls, structural fabrications, pipe, pipe joints, special pipe sections, and other appurtenances in accordance with the accepted schedule of Shop Drawing submittals specified in the Special Provisions or as otherwise provided in the Contract Documents.
- B. The ENGINEER'S review will be only to determine if the items covered by the submittals will, after installation or incorporation in the WORK, generally conform to the Contract Documents and with the design concept of the completed Project. The ENGINEER's favorable review shall be obtained before any such items are manufactured or used in the work. The favorable review of Drawings by the ENGINEER shall apply in general design only and shall in no way relieve the CONTRACTOR from responsibility for errors or omissions contained therein. Favorable review by the ENGINEER shall not relieve the CONTRACTOR of its obligation to meet safety requirements and all other requirements of law. The ENGINEER will start reviewing the CONTRACTOR's submittals only after the

Notice to Proceed is issued by the CITY with the exception of some unusual long lead items which may require submittals prior to issuing the Notice to Proceed.

- C. The CONTRACTOR shall also submit to the ENGINEER for review all Samples in accordance with the accepted schedule of Sample submittals specified in the Special Provisions or as otherwise provided in the Contract Documents.
- D. Before submittal of each Shop Drawing or Sample, the CONTRACTOR shall have determined and verified all quantities, dimensions, specified performance criteria, installation requirements, materials, catalog numbers, and similar data with respect thereto and reviewed or coordinated each Shop Drawing or Sample with other Shop Drawings and Samples and with the requirements of the WORK and the Contract Documents. The CONTRACTOR shall provide submittals in accordance with the requirements of the Special Provisions or as otherwise provided in the Contract Documents.
- E. Shop-drawing submittal and coordination are the responsibility of the prime contractor; this responsibility shall not be delegated in whole or in part to subcontractors or suppliers. Any designation of work "by others," shown on Shop Drawings, shall mean that the work will be the responsibility of the CONTRACTOR rather than the subcontractor or supplier who has prepared the Shop Drawings.

Submittals shall be prepared in such form that data can be identified with the applicable Specification paragraph. The data shall demonstrate clearly compliance with the Drawings and Specifications and shall relate to the specific equipment to be furnished. Where manufacturer's standard drawings are employed, they shall be marked clearly to show what portions of the data are applicable to this Project.

- F. Review of shop-drawing submittals by the ENGINEER has as its primary objective the completion for the CITY of a Project in full conformance with the Drawings and Specifications, unmarred by field corrections, and within the time provided. In addition to this primary objective, shop-drawing review as a secondary objective will assist the CONTRACTOR in its procurement of equipment that will meet all requirements of the Drawings and Specifications, will fit the structures detailed on the Drawings, will be complete with respect to piping, electrical, and control connections, will have the proper functional characteristics, and will become an integral part of a complete operating facility. Acceptance of Shop Drawings and submittals does not constitute a change order to the Contract requirements.
- G. Where the CONTRACTOR is required by these Specifications to make submittals, they shall be submitted to the ENGINEER with a letter of transmittal and in sufficient number of copies to allow a distribution of at least one (1) copy to all parties needing a copy to carry out the provisions of the Specifications, including three (3) copies to be retained by the ENGINEER. The ENGINEER

shall determine the appropriate number of such copies required at the time of the preconstruction conference.

- H. Within twenty-five (25) calendar days of receipt by the ENGINEER of each of the CONTRACTOR's submissions and all appurtenant data required for their review, the appropriate number of copies will be returned to the CONTRACTOR with one of the following notations:
1. Resubmittal not required; correction, if any, noted.
  2. Correct and resubmit; corrections noted.

Returned copies of Drawings marked with Notation "1" authorize the CONTRACTOR to proceed with the operations covered by such returned copies, provided that such operations be subject to the comments, if any, shown on such returned copies. Returned copies of Drawings marked with Notation "2" shall be corrected, as necessary and required, and shall be submitted in the same manner as before.

- I. When submittals are favorably reviewed, the ENGINEER will retain three (3) copies and will return all other copies to the CONTRACTOR. When submittals are not favorably reviewed, the ENGINEER will retain only two (2) copies and will return all others to the CONTRACTOR. It is considered reasonable that the CONTRACTOR shall make a complete and acceptable submission to the ENGINEER at least by the second submission of data. The CITY reserves the right to deduct monies from payments due the CONTRACTOR to cover additional costs of the ENGINEER's review beyond the second submission.
- J. Favorable review by the ENGINEER will not constitute acceptance by the ENGINEER of any responsibility for the accuracy, coordination, and completeness of the Shop Drawings or the items of equipment represented on the Drawings. Accuracy, coordination, and completeness of Shop Drawings shall be the sole responsibility of the CONTRACTOR, including responsibility to back check comments, corrections, and modifications from the ENGINEER's review before fabrication. Supplemental, specific requirements for Shop Drawings and details are contained in the applicable technical sections of these Specifications.
- K. Copies of schedules and Shop Drawings submitted to the ENGINEER for review shall be such as to provide three (3) copies for the ENGINEER's files, and such additional copies as the CONTRACTOR may desire for its own office files and/or for distribution by it to subcontractors or vendors. Exceptions will be noted in specific sections of Specifications. All Shop Drawings and supporting data, catalogs, and schedules shall be submitted as the instruments of the CONTRACTOR, who shall be responsible for their accuracy and completeness. These submittals may be prepared by the CONTRACTOR, subcontractors, or suppliers, but the CONTRACTOR shall ascertain that submittals meet all of the

requirements of the Contract, while conforming to structural, space, and access conditions at the point of installation. The CONTRACTOR shall check all submittals before submitting them to the ENGINEER.

- L. The ENGINEER shall check and review schedules, drawings, etc., submitted by the CONTRACTOR only for general design conformance with the concept of the Project and compliance with the Contract. Shop Drawings shall not be used to order products' fabrication or delivery for construction or installation unless submitted to and favorably reviewed by the ENGINEER. Acceptance by the ENGINEER of any drawings, method of work, or any information regarding materials and equipment the CONTRACTOR proposes to furnish shall not relieve the CONTRACTOR of its responsibility for any errors therein and shall not be regarded as an assumption of risks or liability by the Design ENGINEER or the CITY, or any officer or employee thereof, and the CONTRACTOR shall have no recourse against the CITY under the Contract on account of the failure or partial failure or inefficiency or insufficiency of any plan or method of work or material and equipment so accepted. Such acceptance shall be considered to mean merely that the ENGINEER has no objection to the CONTRACTOR using, upon its own full responsibility, the plan or method of work proposed or furnishing the materials and equipment proposed.

#### 6.15 CONTINUING THE WORK

- A. The CONTRACTOR shall carry on the WORK and adhere to the progress schedule during all disputes or disagreements with the CITY. No WORK shall be delayed or postponed pending resolution of any disputes or disagreements, except as the CONTRACTOR and the CITY may otherwise agree in writing.

#### 6.16 CONTRACTOR'S GENERAL WARRANTY AND GUARANTEE

- A. CONTRACTOR warrants and guarantees that all WORK will be in accordance with the Contract Documents and will not be defective. The CONTRACTOR represents that the WORK performed pursuant to the Contract shall be of the quality specified or of the highest quality if no quality is specified, and shall conform to the Contract Documents. The CONTRACTOR warrants all equipment, material, products, and workmanship furnished and all work performed under the Contract against defects for a period of one (1) year after final acceptance regardless of whether the same were furnished or performed by the CONTRACTOR or by any of its subcontractors or suppliers of any tier.
- B. The CONTRACTOR shall make, at its own expense, all repairs and/or replacements necessitated by defects in the equipment, materials, and/or products and in the workmanship provided by the CONTRACTOR or any of its subcontractors that become evident within the warranty period.

- C. Upon receipt of written notice from the CITY of any breach of warranty during the applicable warranty period, the affected item shall be redesigned, repaired, or replaced by the CONTRACTOR and the CONTRACTOR shall perform such tests as the CITY may require to verify that such redesign, repair, and replacement comply with the requirements of the Contract. The CITY shall have the right to operate and use such equipment, materials, and/or products until they can, without damage to the CITY, be taken out of service for correction or replacement by the CONTRACTOR. As to the redesigned, repaired, or replaced work, the CONTRACTOR warrants such redesigned, repaired, or replaced work against defective design, equipment, materials, products, and workmanship for a period of one (1) year from and after the date of satisfactory completion of such redesigned, repaired, or replaced work. The CITY reserves the right to require that the CONTRACTOR performs such repair or replacement work.
- D. The CITY also reserves the right to make such repairs or replacements, if, within seven (7) calendar days after the mailing of a notice in writing to the CONTRACTOR and Surety, the CONTRACTOR shall neglect to make or undertake with due diligence the aforesaid repairs or replacements and that Surety within seven (7) calendar days after mailing of a notice in writing of such negligence of the CONTRACTOR shall neglect to make or undertake with due diligence the aforesaid repairs or replacements itself, provided, however, that in the case of an emergency where in the opinion of the CITY delay would cause hazard to health or serious loss or damage, repair may be made without notice being sent to the CONTRACTOR or Surety, and the CONTRACTOR shall pay the cost thereof.
- E. All costs including workforce and materials incidental to such redesign, repair, replacement, and testing, including the removal, replacement, and reinstallation of equipment necessary to gain access and all other costs incurred as the result of a breach of warranty shall be borne by the CONTRACTOR whether performed by the CITY or the CONTRACTOR.
- F. Nothing in this section shall be construed to limit, relieve, or release the CONTRACTOR, subcontractor's, and equipment, materials, and/or products suppliers, and other service providers' liability to the CITY for damages sustained as the result of latent defects in the workmanship, equipment, materials, and/or products done and/or furnished by the CONTRACTOR, its subcontractors, suppliers and/or other service providers.
- G. The Performance Bond shall extend for a period of one (1) year after acceptance of the Contract by the CITY and shall cover the CONTRACTOR's obligations resulting from the warranty requirements herein specified.
- H. CONTRACTOR's warranty and guarantee hereunder excludes defects or damage caused by:

1. Abuse, modification, or improper maintenance or operation by persons other than CONTRACTOR, Subcontractors, or Suppliers, or other individual or entity for whom CONTRACTOR is responsible;
  2. Normal wear and tear under normal usage.
- I. CONTRACTOR's obligation to perform and complete the WORK in accordance with the Contract Documents shall be absolute. None of the following will constitute an acceptance of WORK that is not in accordance with the Contract Documents or a release of CONTRACTOR's obligation to perform the WORK in accordance with the Contract Documents:
1. Observations by ENGINEER;
  2. Recommendation by ENGINEER or payment by CITY of any progress or final payment;
  3. The issuance of a Certificate of Completion by the CITY;
  4. Use or occupancy of the WORK or any part thereof by the CITY;
  5. Any acceptance by CITY or any failure to do so;
  6. Any review and approval of a Shop Drawing or Sample submittal or the issuance of a notice or acceptability by ENGINEER pursuant to Paragraph 14.7 B.;
  7. Any inspection, test, or approval by others; or
  8. Any correction of Defective Work by CITY.

#### 6.17 INDEMNIFICATION

- A. Contractor shall indemnify, defend with counsel acceptable to City, and hold harmless to the full extent permitted by law, City and its officers, officials, employees, agents and volunteers from and against any and all liability, loss, damage, claims, expenses and costs (including, without limitation, attorney fees and costs and fees of litigation) (collectively, "Liability") of every nature arising out of or in connection with Contractor's performance of the WORK or its failure to comply with any of its obligations contained in this Agreement, except such Liability caused by the active negligence, sole negligence or willful misconduct of the City. Such indemnification by the CONTRACTOR shall include, but not be limited to, the following:
1. Liability or claims resulting directly or indirectly from the negligence or carelessness of the CONTRACTOR, its subcontractors, employees, or

agents in the performance of the WORK, or in guarding or maintaining the same, or from any improper materials, implements, or appliances used in its construction, or by or on account of any act or omission of the CONTRACTOR, its employees, or agents;

2. Liability or claims arising directly or indirectly from bodily injury, occupational sickness or disease, or death of the CONTRACTOR's, or Supplier's own employees, or agents engaged in the WORK resulting in actions brought by or on behalf of such employees against the CITY and/or the ENGINEER;
3. Liability or claims arising directly or indirectly from or based on the violation of any Laws or Regulations, whether by the CONTRACTOR, its subcontractors, employees, or agents;
4. Liability or claims arising directly or indirectly from the use or manufacture by the CONTRACTOR, its subcontractors, employees, or agents in the performance of this Agreement of any copyrighted or uncopyrighted composition, secret process, patented or unpatented invention, article, or appliance, unless otherwise specified stipulated in this Agreement;
5. Liability or claims arising directly or indirectly from the breach of any warranties, whether express or implied, made to the CITY or any other parties by the CONTRACTOR, its subcontractors, employees, or agents;
6. Liability or claims arising directly or indirectly from the willful misconduct of the CONTRACTOR, its subcontractors, employees, or agents;
7. Liability or claims arising directly or indirectly from any breach of the obligations assumed in this Agreement by the CONTRACTOR;
8. Liability or claims arising directly or indirectly from, relating to, or resulting from a hazardous condition created by the CONTRACTOR, Subcontractors, Suppliers, or any of their employees or agents, and;
9. Liability or claims arising directly, or indirectly, or consequentially out of any action, legal or equitable, brought against the CITY, the ENGINEER, their consultants, subconsultants, and the officers, directors, employees and agents of each or any of them, to the extent caused by the CONTRACTOR's use of any premises acquired by permits, rights of way, or easements, the Site, or any land or area contiguous thereto or its performance of the WORK thereon.

- B. The CONTRACTOR shall reimburse the CITY for all costs and expenses, (including but not limited to fees and charges of engineers, architects, attorneys, and other professionals and court costs of appeal) incurred by said CITY in enforcing the provisions of this Paragraph.
- C. The indemnification obligation under this Article 11 shall not be limited in any way by any limitation on the amount or type of insurance carried by CONTRACTOR or by the amount or type of damages, compensation, or benefits payable by or for the CONTRACTOR or any Subcontractor or other person or organization under workers' compensation acts, disability benefit acts, or other employee benefit acts.
- D. Pursuant to California Public Contract Code Section 9201, City shall timely notify Contractor of receipt of any third-party claim relating to this Agreement.

#### 6.18 CONTRACTOR'S DAILY REPORTS

- A. The CONTRACTOR shall complete a daily report indicating location worked, total manpower for each construction trade, major equipment on Site, each Subcontractor's manpower and equipment, weather conditions, and other related information involved in the performance of the WORK. These components will be decided by the ENGINEER.

#### 6.19 CONTRACT DOCUMENTS AND RECORD DRAWINGS

- A. The CONTRACTOR shall keep on the work site a copy of the Contract Documents and shall at all times give the ENGINEER access thereto. Any drawings included in the Specifications shall be regarded as part thereto and of the Contract. Anything mentioned in these Specifications and not shown on the Project Drawings, or shown on the Project Drawings and not mentioned in these Specifications, shall be of like effect as though shown or mentioned in both. The ENGINEER will furnish from time to time such detail drawings, plans, profiles, and information as he may consider necessary for the CONTRACTOR's guidance. It shall be the duty of the CONTRACTOR to see that the provisions of the Contract Documents are complied with in detail irrespective of the inspection given the work during its progress by the ENGINEER. Any failure on the part of the CONTRACTOR to observe the requirements contained in the Contract Documents will be sufficient cause for the rejection of the work at any time before its acceptance.
- B. The CONTRACTOR shall maintain, at the jobsite, one record set of Drawings in good order and clearly marked to show any deviations which have been made from the Drawings, including concealed construction and utility features which are revealed during the course of construction. Marked prints shall be updated at least once each week and shall be available to the ENGINEER for review as to



currency prior to developing partial payment estimates. Upon completion of the work, the marked set of prints shall be delivered to the ENGINEER.

- C. In the case of those drawings which depict the detail requirement for equipment to be assembled and wired in the factory, such as motor control centers and the like, the Record Drawings shall be updated by indicating those portions which are superseded by change order drawings or final shop drawings, and by including appropriate reference information describing the change orders by number and the shop drawings by manufacturer, drawing, and revision numbers.
- D. Requests for partial payments will not be approved if the updated set of Drawings is not in good order or is not kept current. Request for final payment will not be approved until the complete and correct Record Drawings are delivered to the ENGINEER.

## 6.20 CLEAN UP

The CONTRACTOR shall, at all times, keep the premises, occupied by it in relation to this Contract, in a neat, clean, and safe condition and at all times provide reasonable access thereto. The CONTRACTOR shall, as a minimum, conduct daily inspections to verify that requirements of this Article are being met.

- A. During the progress of the WORK, the CONTRACTOR shall:
  - 1. Retain all stored items in an orderly arrangement allowing maximum access, not impeding drainage or traffic, and providing the required protection of material.
  - 2. Provide adequate storage of all items awaiting removal from the jobsite, observing all requirements for fire protection and protection of the environment.
  - 3. Remove any accumulation of scrap, debris, waste material, and other items not required for construction of this work.
  - 4. Dispose of existing materials and equipment to be demolished and removed and all trash such as broken concrete, wood blocking, shipping containers, etc., resulting from the contract work off the premises occupied by the CONTRACTOR, including CITY property, at the CONTRACTOR's expense. CITY-leased dumpsters and other disposal containers on CITY's property, unless specifically provided by the CONTRACTOR, shall not be used by the CONTRACTOR.
  - 5. Maintain all excavation, embankments, haul roads, permanent access roads, Plant site, waste disposal areas, borrow areas, and all other work areas within contract work limits free from dust, as determined by the

ENGINEER. Industry-accepted methods of dust control suitable for the area involved, such as sprinkling, chemical treatment, light bituminous treatment, or similar methods, will be permitted. No separate payment will be made to the CONTRACTOR for dust control.

- B. If the CONTRACTOR fails to comply with any of the foregoing, the CITY will transmit written notification of noncompliance. If, within five (5) calendar days of the written notification, the CONTRACTOR fails to comply, cleanup may be undertaken by the CITY at the expense of the CONTRACTOR.
- C. Upon completion of any portion of any WORK, the CONTRACTOR shall promptly remove all of its equipment, temporary structures, and surplus construction and other materials not to be used at or near the same location during later stages of work. Upon completion of any WORK and before final inspection is made, the CONTRACTOR shall unless otherwise specifically directed by the ENGINEER:
  - 1. Remove from the job site all plant, buildings, tools, surplus materials, equipment, forms, rubbish, scrap, debris, and waste.
  - 2. Clean all paved areas on the site. Completely remove all resultant debris.
  - 3. Visually inspect all interior surfaces, and remove all traces of soil, waste material, smudges, and other foreign matter. Remove all traces of splashed materials from adjacent surfaces. Remove all paint droppings, spots, stains, and dirt from finished surfaces. Use only approved cleaning materials and equipment.
  - 4. Restore any improved area used for the CONTRACTOR's work or material storage to its condition at the time the CONTRACTOR moved onto the site or to the satisfaction of the ENGINEER.
  - 5. Schedule final cleaning and improvement restoration to enable the CITY to accept a completely clean and restored project.

## 6.21 STORM WATER POLLUTION PREVENTION

### A. General

- 1. Prevention - The CONTRACTOR shall prevent the pollution of storm drain systems and creeks on or near the construction project site(s) resulting from the construction operation. The CONTRACTOR shall keep pollution out of storm drains by reducing the possibility of accidental discharge of materials and wastes, by reducing erosion and sedimentation, and by any action as required. The CONTRACTOR shall train all employees and subcontractors on the storm water pollution prevention

requirements contained in these Specifications and ensure that all employees and subcontractors are aware of the consequences as described in subsection A.3. below. The CONTRACTOR shall include appropriate subcontract provisions to ensure that these requirements are met by all subcontractors.

2. Notification - If the CONTRACTOR causes or permits the spillage or overflow of any sewage, oil, or petroleum product, hazardous substance, contaminant, or waste that may result in the fluid or substance being discharged directly or indirectly into any storm drains, creeks, wetlands, or other manmade or natural waterways the CONTRACTOR shall notify the CITY as soon as possible to the extent notification can be provided without substantially impeding cleanup or other emergency measures. In no event shall such notification be later than one hour after knowledge of the occurrence.
3. Cleanup - Immediately upon gaining knowledge of such spillage, overflow, or discharge, the CONTRACTOR shall eliminate the cause of the spillage, overflow, or discharge and take action to minimize any damages. The CONTRACTOR shall also immediately implement a cleanup program. The cleanup, including sampling and testing required by regulatory agencies to determine the nature and level of contamination shall be performed and completed to the satisfaction of the various regulatory agencies involved and the CITY, at the expense of the CONTRACTOR. Any fines, penalties, and/or subsequent actions imposed upon the CITY and/or the CONTRACTOR by regulatory agencies related to the spillage, overflow, or discharge and any subsequent monitoring, testing, and reporting, as required by regulatory agencies, shall also be at the expense of the CONTRACTOR. The CONTRACTOR shall keep a stockpile of spill cleanup materials, such as rags or absorbents, readily accessible on site. The quantity of cleanup materials shall be appropriate in consideration of the risk of an occurrence of a spill, overflow or discharge.

B. Management of Nonhazardous Material and/or Waste

1. Designated Area - The CONTRACTOR shall propose designated areas of the project site, for approval by the ENGINEER, suitable for material delivery, storage, and waste collection that to the maximum extent practicable are near construction entrances and away from catch basins, gutters, drainage courses, and creeks.
2. Backfill or Excavated Material - The CONTRACTOR shall not allow backfill or excavated material to enter the storm drains or creeks. When rain is forecast within 24 hours or during wet weather, the

CONTRACTOR may be required to cover such material with a tarpaulin and to surround the material with sand bags.

3. Street Sweeping - At least once per week or more frequently as directed by the ENGINEER, the CONTRACTOR shall clean and sweep roadways and on-site paved areas of all materials attributed to or involved in the work. The CONTRACTOR shall not use water to flush down streets in place of street sweeping.
4. Disposal - At the end of each working day, the CONTRACTOR shall collect all scrap, debris, and waste material, and dispose of such materials properly. The materials may be stored in the CONTRACTOR's yard in stockpiles or placed in dumpsters. The CONTRACTOR shall inspect dumpsters for leaks and replace or repair dumpsters that leak. The CONTRACTOR shall not discharge water from cleaning dumpsters on site. The CONTRACTOR shall arrange for regular waste collection before dumpsters overflow.

C. Management of Hazardous Material and/or Waste

1. Storage - The CONTRACTOR shall label and store all hazardous materials, such as pesticides, paints, thinners, solvents, and fuels, and all hazardous wastes, such as waste oil and antifreeze in accordance with all applicable state and federal regulations. The CONTRACTOR shall store all hazardous materials and all hazardous wastes in accordance with secondary containment regulations. All such materials and wastes shall be covered, as needed, to avoid rainwater becoming polluted with hazardous constituents which could result in potential management of collected rain water as a hazardous waste. The CONTRACTOR shall keep an accurate, up-to-date inventory, including Material Safety Data Sheets (MSDSs), of hazardous materials and hazardous wastes stored on site.
2. Usage - When rain is forecast within 24 hours or during wet weather, the CONTRACTOR shall refrain from applying chemicals in outside areas. The CONTRACTOR shall follow material manufacturer's instructions regarding uses, protective equipment, ventilation, flammability, and mixing of chemicals. The CONTRACTOR shall post warning signs in areas treated with chemicals.
3. Disposal - The CONTRACTOR shall arrange for regular hazardous waste collection to comply with time limits on storage of hazardous wastes. The CONTRACTOR shall dispose of hazardous waste in accordance with all applicable local, state and federal regulations. The CONTRACTOR shall not wash any spilled material into streets, gutters, storm drains, or creeks and shall not bury spilled hazardous materials. The CONTRACTOR shall

report any hazardous materials spill to the CITY in accordance with Section A.2 above.

D. Vehicle/Equipment Cleaning, Maintenance, and Fueling

1. General - The CONTRACTOR shall inspect vehicles and equipment arriving on site for leaking fluids and shall promptly repair leaking vehicles and equipment. Drip pans shall be used to catch leaks until repairs are made.

The CONTRACTOR shall comply with federal, state, and city requirements for aboveground storage tanks.

2. Cleaning - The CONTRACTOR shall perform vehicle or equipment cleaning with water only in a designated, bermed area that will not allow rinse water to run off site into streets, gutters, storm drains, or creeks. Soaps, solvents, degreasers, steam-cleaning equipment, or equivalent methods shall not be allowed.
3. Maintenance and Fueling - The CONTRACTOR shall perform maintenance and fueling of vehicles or equipment in areas that will not allow run-on of storm water or runoff of spills to storm drains and provide for confined clean-up. Examples are working in bermed areas or utilizing drip pans. The CONTRACTOR shall not contaminate the soils or groundwater with such maintenance and fueling activities.

The CONTRACTOR shall use secondary containment, such as a drip pan, to catch leaks or spills any time that vehicle or equipment fluids are dispensed, changed, or poured, and shall clean up leaks and spills of vehicle or equipment fluids immediately and dispose of the waste and cleanup materials as hazardous waste, as described in Section C.3 above.

E. Dewatering Operations

1. Sediment Control - The CONTRACTOR shall route water through a control measure, such as a sediment trap, sediment basin, or Baker tank, to remove settleable solids prior to discharge to the storm drain system. Straw bales shall be placed in front of storm drain inlets as required. Filtration of the water following the control measure may be required on a case-by-case basis. Approval of the control measure shall be obtained in advance from the ENGINEER. If the ENGINEER determines that the dewatering operation would not generate an appreciable amount of settleable solids, the control measure requirement above may be waived.
2. Contaminated Groundwater - If the project is within an area of known groundwater contamination or if contamination is found, water from

dewatering operations shall be tested prior to discharge. If the water quality meets Regional Water Quality Control Board (RWQCB) standards, it may be discharged to a storm drain or creek. Otherwise, the water shall be hauled off site for proper disposal.

F. Paving or Oiling Operations

1. When rain is forecast within 24 hours or during wet weather, the ENGINEER may prevent the CONTRACTOR from paving or oiling the street. The ENGINEER may direct the CONTRACTOR to protect drainage courses by using control measures, such as earth dike, straw bale, and sand bag, to divert runoff or trap and filter sediment.
2. The CONTRACTOR shall prevent saw-cut slurry from entering catch basins and storm drains by limiting the area over which the slurry may spread.
3. The CONTRACTOR shall cover catch basins and manholes when paving or applying seal coat, tack coat, slurry seal, or fog seal.
4. The CONTRACTOR shall not sweep or wash down excess sand (placed as part of a sand seal or to absorb excess oil) into gutters, storm drains, or creeks. The CONTRACTOR shall either collect the sand and return it to the stockpile or dispose of it in a trash container.

G. Concrete, Grout, and Mortar Waste Management

1. Concrete Truck/Equipment Washout - The CONTRACTOR shall not wash out concrete trucks or equipment into streets, gutters, storm drains, or creeks. The CONTRACTOR shall perform washout of concrete trucks or equipment off site or in a designated area on site where the water will flow onto dirt or into a temporary pit in a dirt area. The CONTRACTOR shall let the water percolate into the soil and dispose of the hardened concrete in a trash container. If a suitable dirt area is not available, the CONTRACTOR shall collect the wash water and remove it off site.
2. Exposed Aggregate Concrete Wash Water - The CONTRACTOR shall avoid creating runoff by draining water from washing of exposed aggregate concrete to a dirt area. If a suitable dirt area is not available, the CONTRACTOR shall filter the wash water through straw bales or equivalent material before discharging to a storm drain. The CONTRACTOR shall collect sweepings from exposed aggregate concrete for disposal.

H. Paint Disposal and Clean-up

1. Disposal of Unused Paint - The CONTRACTOR shall carefully use, store and dispose of paint, solvents, chemicals, and waste materials in compliance with all applicable state and federal regulations. The CONTRACTOR shall not dispose of paint to sanitary sewer systems or storm drains. The CONTRACTOR shall utilize other recycling and disposal services as follows:
  - a. "Recycling Centers" and "Waste Disposals" as may be listed in the yellow pages.
  - b. Local household hazardous waste facility if appropriate.

The CONTRACTOR may dispose of small amounts of leftover latex (water-based) paint by applying the paint to the surface of an item to be discarded and allowing it to dry thoroughly, then disposing of it in a dumpster.

The CONTRACTOR shall store these materials and conduct cleaning of painting equipment and tools in a designated area that will not allow run-on of storm water or runoff of spills. The CONTRACTOR shall not allow wash water from cleaning of painting equipment and tools into streets, gutters, storm drains, or creeks.

2. Disposal of Paint Clean-up Waste - The CONTRACTOR shall remove as much excess paint as possible from brushes, rollers, and equipment before starting cleanup.
  - a. The CONTRACTOR shall not discharge cleaning wastes from oil-based paints, buckets, brushes or tools to the sanitary sewer system. The CONTRACTOR shall retain a certified waste hauler to recycle or to dispose of cleaning wastes from oil-based paints at the CONTRACTOR's expense.
  - b. The CONTRACTOR may discharge very small amounts of cleaning wastes from brushes, rollers, buckets, and tools contaminated with latex (water-based) paints to the sanitary sewer system provided they do not contain additives with pollutants of concern (e.g., mercury, tributyltin). Brushes, rollers, and tools containing latex paints may be washed over a sink with plenty of water. Buckets containing latex paints shall first be emptied into the original can or discarded as specified in paragraph 1 above. Should excessive amounts of paint or solvent be found in the wastewater discharged, the CONTRACTOR may be subject to

enforcement action by the CITY in accordance with the City Codes.

- c. The CONTRACTOR shall not discharge any of these paint clean-up wastes to storm drains, streets, gutters, or creeks.
  - d. Waste Disposal - The CONTRACTOR shall dispose of waste thinner, solvent, and sludge from cleaning of equipment and tools as hazardous waste, as described in Section C.3 above. The CONTRACTOR shall dispose of excess thinners, solvents, and oil- and water-based paint as hazardous waste.
- I. Contaminated Soil - If the project is within an area of known soil contamination or evidence of soil contamination is found, the CONTRACTOR shall comply with the requirements of all applicable local, state and federal regulations.

## **ARTICLE 7 – OTHER WORK**

### **7.1 RELATED WORK AT SITE**

- A. The CITY may perform other work related to the Project at the Site by the CITY's own forces, have other work performed by utility owners, or let other direct contracts for such other work. If the fact that such other work is to be performed was not noted in the Contract Documents, written notice thereof will be given to the CONTRACTOR prior to starting any such other work.
- B. The CONTRACTOR shall afford each person who is performing the other work (including the CITY's employees) proper and safe access to the Site and a reasonable opportunity for the introduction and storage of materials and equipment and the execution of such other work, and shall properly coordinate the WORK with theirs. The CONTRACTOR shall do all cutting, fitting, and patching of the WORK that may be required to properly connect or otherwise make its several parts come together and properly integrate with such other work. The CONTRACTOR shall not endanger any work of others by cutting, excavating, or otherwise altering their work and will not only cut or alter their work with the written consent of the ENGINEER and the others whose work will be affected.
- C. If the proper execution or results of any part of the CONTRACTOR's work depends upon such other work by another, the CONTRACTOR shall inspect and report to the ENGINEER in writing any delays, defects, or deficiencies in such other work that render it unavailable or unsuitable for such proper execution and results. The CONTRACTOR's failure to report such delays, defects, or deficiencies will constitute an acceptance of the other work as fit and proper for integration with the CONTRACTOR's work except for latent or nonapparent defects and deficiencies in the other work.



## 7.2 COORDINATION

- A. If the CITY contracts with others for the performance of other work at the Site, CITY will have sole authority and responsibility in respect of such coordination, unless otherwise provided in the Supplementary General Conditions.

## ARTICLE 8 – CITY’S RESPONSIBILITIES

### 8.1 COMMUNICATIONS

- A. Except as may be otherwise provided in these General Conditions or the Supplementary General Conditions, the CITY will issue all its communications to the CONTRACTOR through the ENGINEER.

### 8.2 PAYMENTS

- A. The CITY will make payments to the CONTRACTOR as provided in Article 14.

### 8.3 LANDS, EASEMENTS, AND SURVEYS

- A. The CITY’s duties in respect of providing lands and easements and providing engineering surveys to establish reference points are set forth in Paragraphs 4.1 and 4.6.

### 8.4 REPORTS AND DRAWINGS

- A. The CITY will identify and make available to the CONTRACTOR copies of reports of physical conditions at the Site and drawings of existing structures which have been utilized in preparing the Contract Documents as set forth in Paragraph 4.2.

### 8.5 CHANGE ORDERS

- A. The CITY will execute Change Orders as indicated in Article 10.

### 8.6 INSPECTIONS AND TESTS

- A. The CITY’S responsibility for inspections and tests is set forth in Paragraph 13.3.

### 8.7 SUSPENSION OF WORK

- A. The CITY’s right to stop work or suspend work is set forth in Paragraphs 13.4 and 15.1.

## 8.8 TERMINATION OF AGREEMENT

- A. The CITY's right to terminate services of the CONTRACTOR is set forth in Paragraphs 15.2 and 15.3.

## 8.9 LIMITATION ON CITY'S RESPONSIBILITIES

- A. The CITY shall not supervise, direct or have control or authority over, nor be responsible for CONTRACTOR's means, methods, techniques, sequences, or procedures of construction or the safety precautions and programs incident thereto, or for any failure of CONTRACTOR to comply with Laws and Regulations applicable to the furnishing or performance of the WORK. CITY will not be responsible for CONTRACTOR's failure to perform or furnish the WORK in accordance with the Contract Documents.

## 8.10 UNDISCLOSED HAZARDOUS ENVIRONMENTAL CONDITIONS

- A. CITY's responsibility in respect to an undisclosed hazardous environmental condition is set forth in Paragraph 4.5.

## **ARTICLE 9 – ENGINEER’S STATUS DURING CONSTRUCTION**

### **9.1 CITY’S REPRESENTATIVE**

- A. The ENGINEER will be the CITY’S representative during the construction period. The ENGINEER shall decide any and all questions which may arise as to the quality or acceptability of materials furnished and work performed, and as to the manner of performance and rate of progress of the work; all questions which arise as to the interpretation of the plans and specifications, the proposal and the contract documents therefor; all questions as to the acceptable fulfillment of the contract on the part of the CONTRACTOR; and all questions as to claim and compensation.

### **9.2 OBSERVATIONS ON THE SITE**

- A. The ENGINEER will make observations on the Site during construction to monitor the progress and quality of the WORK and to determine, in general, if the WORK is proceeding in accordance with the Contract Documents. The ENGINEER will not be required to make exhaustive or continuous inspections to check the quality or quantity of the WORK.

### **9.3 PROJECT REPRESENTATION**

- A. The ENGINEER may furnish a Resident Project Representative to assist in observing the performance of the WORK. The duties, responsibilities, and limitations of authority of any such Resident Project Representative will be as provided in the Supplementary General Conditions.

### **9.4 CLARIFICATIONS**

- A. The ENGINEER will issue with reasonable promptness such written Clarifications of the requirements of the Contract Documents as the ENGINEER may determine necessary, which shall be consistent with or reasonably inferable from the overall intent of the Contract Documents.

### **9.5 AUTHORIZED VARIATIONS IN WORK**

- A. The ENGINEER may authorize variations in the WORK from the requirements of the Contract Documents. These may be accomplished by a Field Order and will require the CONTRACTOR to perform the WORK involved in a manner that minimizes the impact to the WORK and the Contract Times. If the CONTRACTOR believes that a Field Order justifies an increase in the Contract Price or an extension of the Contract Times, the CONTRACTOR may make a claim therefor as provided in Article 11 or 12.

## 9.6 REJECTING DEFECTIVE WORK

- A. The ENGINEER will have authority to reject Defective Work and will also have authority to require special inspection or testing of the WORK as provided in Article 13.

## 9.7 CONTRACTOR SUBMITTALS, CHANGE ORDERS, AND PAYMENTS

- A. In accordance with the procedures set forth in the General Requirements, the ENGINEER will review all CONTRACTOR submittals.
- B. The ENGINEER's responsibilities for Change Orders are set forth in Articles 10, 11, and 12.
- C. The ENGINEER's responsibilities for Applications for payment are set forth in Article 14.

## 9.8 DECISIONS ON DISPUTES

- A. The ENGINEER will be the initial interpreter of the requirements of the Contract Documents and of the acceptability of the WORK thereunder. Claims, disputes, and other matters relating to the acceptability of the WORK and interpretation of the requirements of the Contract Document pertaining to the performance of the work shall be determined by the ENGINEER. Any claims in respect to changes in the Contract Price or Contract Times shall be resolved in accordance with the requirements set forth in Articles 10, 11, and 12.

## 9.9 LIMITATIONS ON ENGINEER'S RESPONSIBILITIES

- A. Neither the ENGINEER's authority to act under this Article 9 or other provisions of the Contract Documents nor any decision made by the ENGINEER in good faith either to exercise or not exercise such authority shall give rise to any duty or responsibility of the ENGINEER to the CONTRACTOR, any Subcontractor, any Supplier, any surety for any of them, or any other person or organization performing any of the WORK.
- B. Whenever in the Contract Documents the terms "as ordered," "as directed," "as required," "as allowed," "as reviewed," "as approved," or terms of like effect or import are used, or the adjectives "reasonable," "suitable," "acceptable," "proper," or "satisfactory," or adjectives of like effect or import are used to describe a requirement, direction, review, or judgment will be solely to evaluate the WORK for compliance with the requirements of the Contract Documents, and conformance with the design concept of the completed Project as a functioning whole as indicated by the Contract Documents, unless there is a specific statement indicating otherwise. The use of any such term or adjective shall not be effective to assign to the ENGINEER any duty or authority

to supervise or direct the performance of the WORK or any duty or authority to undertake responsibility contrary to the provisions of Paragraph 9.9 C.

- C. The ENGINEER will not supervise, direct, control, or have authority over or be responsible for the CONTRACTOR's means, methods, techniques, sequences, or procedures of construction, or the safety precautions and programs incident thereto, or for any failure of the CONTRACTOR to comply with Laws and Regulations applicable to the performance of the WORK. The ENGINEER will not be responsible for the CONTRACTOR's failure to perform the WORK in accordance with the Contract Documents. The ENGINEER will not be responsible for the acts or omissions of the CONTRACTOR nor of any Subcontractor, Supplier, or any other person or organization performing any of the WORK.

## **ARTICLE 10 – CHANGES IN THE WORK**

### **10.1 GENERAL**

- A. Without invalidating the Agreement and without notice to any surety, the CITY may at any time or from time to time, order additions, deletions, or revisions in the WORK. Such additions, deletions or revisions will be authorized by a Change Order or Field Order. Upon receipt of any such document, CONTRACTOR shall promptly proceed to implement the additions, deletions, or revisions in the WORK in accordance with the applicable conditions of the Contract Documents.
- B. The CONTRACTOR shall not be entitled to an increase in the contract Price nor an extension of the Contract Times with respect to any work performed that is not required by the Contract Documents as amended, modified, or supplemented by Change Order, except in the case of an emergency and except in the case of uncovering work as provided in Paragraph 13.3.F and G.
- C. The CITY and the CONTRACTOR shall execute appropriate Change Orders covering:
  - 1. Changes in the WORK which are ordered by the CITY pursuant to Paragraph 10.1 A.;
  - 2. Changes required because of acceptance of Defective Work under Paragraph 13.6; and
  - 3. Changes in the Contract Price or Contract Times which are agreed to by the parties under Articles 11 and/or 12, respectively.
- D. If notice of any change in the WORK is required to be given to a surety, the giving of any such notice shall be the CONTRACTOR's responsibility. If the change in the WORK affects the Contract Price, the CITY may require an

adjustment to the amount of any applicable Bond and the amount of each applicable Bond shall be adjusted accordingly.

- E. If the CITY and CONTRACTOR agree as to the extent, if any, of an increase in the Contract Price or an extension or shortening of the Contract Times that should be allowed as a result of a Field Order, the CONTRACTOR shall proceed so as to minimize the impact on and delays to the WORK pending the issuance of a Change Order.
- F. If the CITY and the CONTRACTOR are unable to agree as to the extent, if any, of an increase in the Contract Price or an extension or shortening of the Contract Times that should be allowed as a result of a Field Order, the ENGINEER can direct the CONTRACTOR to proceed on the basis of time and materials so as to minimize the impact on and delays to the WORK, and the CONTRACTOR may make a claim as provided in Articles 11 and 12.

## 10.2 ALLOWABLE QUANTITY VARIATIONS

- A. In the event of an increase or decrease in the quantity of any bid item under a unit price contract, the total amount of work actually done or materials or equipment furnished will be paid for according to the unit price established for such work under the Contract Documents, wherever such unit price has been established; provided, that an adjustment in the Contract Price may be made for changes which result in an increase or decrease in excess of 25 percent of the estimated quantity of any unit price bid item of the WORK.
- B. In the event a part of the WORK is to be entirely eliminated and no lump sum or unit price is named in the Contract Documents to cover such eliminated work, the price of the eliminated work shall be agreed upon by the CITY and the CONTRACTOR by Change Order.

## **ARTICLE 11 – CHANGE OF CONTRACT PRICE**

### 11.1 GENERAL

- A. The Contract Price constitutes the total compensation payable to the CONTRACTOR FOR PERFORMING THE work. All duties, responsibilities, and obligations assigned to or undertaken by the CONTRACTOR to complete the WORK shall be at its expense without change in the Contract Price.
- B. The Contract Price may only be changed by a Change Order. The value of any work covered by a Change Order or of any claim for an increase or decrease in the Contract Price shall be determined in one of the following ways:

1. Where the work involved is covered by unit prices contained in the Contract Documents, by application of unit prices to the quantities of the items involved.
  2. By mutual acceptance of a lump sum, which may include an allowance for overhead and profit not necessarily in accordance with Paragraph 11.4; or
  3. On the basis of the cost of work (determined as provided in Paragraph 11.3) plus the CONTRACTOR's overhead and profit (determined as provided in Paragraph 11.4).
- C. Any claim for an increase in the Contract Price shall be based on written notice delivered by the CONTRACTOR to the ENGINEER promptly (but in no event later than 10 days) after the start of the event giving rise to the claim and shall state the general nature of the claim. Notice of the amount of the claim with supporting data shall be delivered within 60 days after the start of such event (unless the ENGINEER allows an additional period of time to ascertain more accurate data in support of the claim) and shall be accompanied by the CONTRACTOR's written statement that the amount claimed covers all known amounts (direct, indirect, and consequential) to which the CONTRACTOR is entitled as a result of such event. All claims for adjustment in the Contract Price will be determined by the ENGINEER. No claim for an adjustment in the Contract Price will be valid if not submitted in accordance with this Paragraph 11.1 C.

## 11.2 COSTS RELATING TO WEATHER

- A. The CONTRACTOR shall have no claims against the CITY for damages for any injury to work, materials, or equipment, resulting from the action of the elements. If, however, in the opinion of the ENGINEER, the CONTRACTOR has made all reasonable efforts to protect the materials, equipment, and work, the CONTRACTOR may be granted a reasonable extension of Contract Times to make proper repairs, renewals, and replacements of the work, materials, or equipment.

## 11.3 COST OF WORK (BASED ON TIME AND MATERIALS)

- A. **General:** The term "cost of work" means the sum of all costs necessarily incurred and paid by the CONTRACTOR for labor, materials, and equipment in the proper performance of extra work. Except as otherwise may be agreed to in writing by the CITY, such costs shall be in amounts no higher than those prevailing in the locality of the Project, shall include only the following items and shall not include any of the costs itemized in Paragraph 11.5.
- B. **Labor:** The costs of labor will be the actual cost for wages prevailing for each craft or type of workers performing the extra work at the time the extra work is

done, plus employer payments of payroll taxes, workers compensation insurance, liability insurance, health and welfare, pension, vacation, apprenticeship funds, and other direct costs resulting from federal, state or local laws, as well as assessments or benefits required by lawful collective bargaining agreements. Labor costs for equipment operators and helpers will be paid only when such costs are not included in the invoice for equipment rental. The labor costs for foremen shall be proportioned to all of their assigned work and only that applicable to extra work shall be paid. Nondirect labor costs including superintendence shall be considered part of the markup set out in Paragraph 11.4.

C. **Materials:** Materials must be specifically authorized by the ENGINEER. The cost of materials reported shall be at invoice or lowest current price at which materials are locally available and delivered to the Site in the quantities involved, plus the cost of freight, delivery and storage, subject to the following:

1. All trade discounts and rebaters shall accrue to the CITY, and the CONTRACTOR shall make provisions so that they may be obtained;
2. For materials secured by other than a direct purchase and direct billing to the purchaser, the cost shall be deemed to be the price paid to the actual supplier as determined by the ENGINEER. Except for actual costs incurred in the handling of such materials, markup will not be allowed;
3. Payment for materials from sources owned wholly or in part by the purchaser shall not exceed the price paid by the purchaser for similar materials from said sources on extra work items or the current wholesale price for such materials delivered to the Site, whichever price is lower; and
4. If in the opinion of the ENGINEER the cost of material is excessive, or the CONTRACTOR does not furnish satisfactory evidence of the cost of such material, then the cost shall be deemed to be the lowest current wholesale price for the quantity concerned delivered to the Site less trade discount. The CITY reserves the right to furnish materials for the extra work and no claim will be allowed by the CONTRACTOR for costs and profit on such materials.

D. **Equipment:** The CONTRACTOR will be paid for the use of equipment at the rental rate listed for such equipment specified in the current California Department of Transportation publication entitled "Labor Surcharge and Equipment Rental Rates." Such rental rate will be used to compute payments for equipment whether the equipment is under the CONTRACTOR's control through direct ownership, leasing, renting, or another method of acquisition. The rental rate to be applied for use of each item of equipment will be the rate resulting in the least total cost to the CITY for the total period of use. If it is deemed necessary by the CONTRACTOR to use equipment not listed in the above-



referenced publication, an equitable rental rate for the equipment will be established by the ENGINEER. The CONTRACTOR may furnish cost data which might assist the ENGINEER in the establishment of the rental rate. Payment for equipment shall be subject to the following:

1. All equipment shall, in the opinion of the ENGINEER, be in good working condition and suitable for the purpose for which the equipment is to be used;
2. Before construction equipment is used on the extra work, the CONTRACTOR shall plainly stencil or stamp an identifying number thereon at a conspicuous location, and shall furnish to the ENGINEER, in duplicate, a description of the equipment and its identifying number;
3. Unless otherwise specified, manufacturer's ratings and manufacturer approved modifications shall be used to classify equipment for determination of applicable rental rates. Equipment which has no direct power unit shall be powered by a unit of at least the minimum rating recommended by the manufacturer;
4. Individual pieces of equipment or tools having a replacement value of \$500 or less, whether or not consumed by use, will be considered to be small tools and no payment will be made therefore.

E. **Equipment Rental Time:** The rental time to be paid for equipment on the Site will be the time the equipment is in productive operation on the extra work being performed and, in addition, will include the time required to move the equipment to the location of the extra work and return it to the original location or to another location requiring no more time than that required to return it to its original location; except, that moving time will not be paid if the equipment is used on other than the extra work, even though located at the Site of the extra work. Loading and transporting costs will be allowed, in lieu of moving time, when the equipment is moved by means other than its own power, except that no payment will be made for loading and transporting costs when the equipment is used at the Site of the extra work on other than the extra work. Rental time will not be allowed while equipment is inoperative due to breakdowns. The rental time of equipment on the work Site will be computed subject to the following:

1. When hourly rates are listed, any part of an hour less than 30 minutes of operation will be considered to be half-hour of operation, and any part of an hour in excess of 30 minutes will be considered one hour of operation;
2. When daily rates are listed, any part of a day less than 4 hours operation will be considered to be half-day of operation. When owner-operated equipment is used to perform extra work to be paid for on a time and

materials basis, the CONTRACTOR will be paid for the equipment and operator, as set forth in Paragraphs 3, 4, and 5, following;

3. Payment for the equipment will be made in accordance with the provisions in Paragraph 11.3 D., herein;
4. Payment for the cost of labor and subsistence or travel allowance will be made at the rates paid by the CONTRACTOR to other workers operating similar equipment already on the Site, or in the absence of such labor, established by collective bargaining agreements for the type of workmen and location of the extra work, whether or not the operator is actually covered by such an agreement. A labor surcharge will be added to the cost of labor described herein accordance with the provisions of Paragraph 11.3 B., herein, which surcharge shall constitute full compensation for payments imposed by state and federal laws and all other payments made to or on behalf of workers other than actual wages; and
5. To the direct cost of equipment rental and labor, computed as provided herein, will be added the allowances for equipment rental and labor as provided in Paragraph 11.4, herein.

F. **Special Services:** Special work or services are defined as that work characterized by extraordinary complexity, sophistication, innovation, or a combination of the foregoing attributes which are unique to the construction industry. The ENGINEER will make estimates for payment for special services and may consider the following:

1. When the ENGINEER and the CONTRACTOR, determine that a special service or work is required which cannot be performed by the forces of the CONTRACTOR or those of any of its Subcontractors, the special service or work may be performed by an entity especially skilled in the work to be performed. After validation of invoices and determination of market values by the ENGINEER, invoices for special services or work based upon the current fair market value thereof may be accepted without complete itemization of labor, material, and equipment rental costs;
2. When the CONTRACTOR is required to perform work necessitating special fabrication or matching process in a fabrication or a machine shop facility away from the Site, the charges for that portion of the work performed at the off-site facility may, by agreement, be accepted as a special service and accordingly, the invoices for the work may be accepted without detailed itemization; and
3. All invoices for special services will be adjusted by deducting all trade discounts. In lieu of the allowances for overhead and profit specified in

Paragraph 11.4, herein, an allowance of 15 percent will be added to invoices for special services.

- G. **Sureties;** All work performed hereunder shall be subject to all provisions of the Contract Documents and the CONTRACTOR's sureties shall be bound with reference thereto as under the original Agreement. Copies of all amendments to Bonds or supplemental Bonds shall be submitted to the CITY for review prior to the performance of any work hereunder.

#### 11.4 CONTRACTOR'S OVERHEAD AND PROFIT

- A. Extra work ordered on the basis of time and materials will be paid for at the actual necessary cost as determined by the ENGINEER, plus allowances for overhead and profit. No additional mark-ups and/or surcharges will be added to the cost. The allowance for overhead and profit will include full compensation for superintendence, taxes, field office expense, extended overhead, home office overhead, and all other items of expense or cost not included in the cost of labor, materials, or equipment provided for under Paragraph 11.3. The allowance for overhead and profit will be made in accordance with the following schedule:

##### Overhead and Profit Allowance

Labor ..... 20 percent  
Materials ..... 15 percent  
Equipment ... 15 percent

To the sum of the costs and markups provided for in this Article, an additional 2 percent of the sum will be added as compensation for Bonds and insurance.

- B. It is understood that labor, materials, and equipment for extra work may be furnished by the CONTRACTOR or by the Subcontractor on behalf of the CONTRACTOR. When all or any part of the extra work is performed by a Subcontractor, the allowance specified herein will be applied to the labor, materials, and equipment costs of the Subcontractor, to which the CONTRACTOR may add 5 percent of the Subcontractor's total cost for the extra work. Regardless of the number of hierarchical tiers of Subcontractors, the 5 percent increase above the Subcontractor's total cost which includes the allowances for overhead and profit specified herein may be applied one time only.

#### 11.5 EXCLUDED COSTS

- A. The term "cost of the work" shall not include any of the following:
  - 1. Payroll costs and other compensation of CONTRACTOR's officers, executives, proprietors, partners, principals, general managers, engineers, architects, estimators, attorneys, auditors, accountants, purchasing and

contracting agents, expeditors, timekeepers, clerks, and other personnel employed by CONTRACTOR whether at the Site or in CONTRACTOR's principal or a branch office for general administration of the WORK all of which are to be considered administrative costs covered by the CONTRACTOR's allowance for overhead and profit;

2. Non-direct labor costs, including superintendence, shall be considered part of the markup for overhead and profit, and no additional payment will be allowed for such;
3. Expenses of CONTRACTOR's principal and branch offices other than CONTRACTOR's office at the Site;
4. Any part of CONTRACTOR's capital expenses, including interest on CONTRACTOR's capital employed for the WORK and charges against CONTRACTOR for delinquent payments;
5. Cost of premiums for all Bonds and for all insurance whether or no CONTRACTOR is required by the Contract Documents to purchase and maintain the same (except as provided by Paragraph 11.4 above);
6. Costs due to the negligence of CONTRACTOR, any Subcontractor, or anyone directly or indirectly employed by any of them or for whose acts any of them may be liable, including but not limited to, the correction of Defective Work, disposal of materials or equipment wrongly supplied, and making good any damages to property; and
7. Other overhead or general expense costs of any kind and the cost of any item not specifically and expressly included in Paragraph 11.4.

#### 11.6 CONTRACTOR'S EXTRA WORK REPORT

- A. In order to be paid for extra work, the CONTRACTOR must submit a daily extra work report on the form furnished by the ENGINEER. The form must be completely filled out based on the provisions of Paragraphs 11.3 through 11.5 and signed by the CONTRACTOR and ENGINEER at the end of each work day. Failure to complete the form and obtain appropriate signatures by the next working day after the extra work of the previous day was completed will result in CONTRACTOR's costs for extra work being disallowed.

## ARTICLE 12 – CHANGE OF CONTRACT TIMES

### 12.1 GENERAL

- A. The Contract Times may only be changed by a Change Order. Any claim for an extension of the Contract Times shall be based on written notice delivered by the CONTRACTOR to the ENGINEER promptly (but in no event later than 10 days) after the start of the event giving rise to the claim and stating the general nature of the claim. Notice of the extent of the claim with supporting data shall be delivered within 30 days after the start of such event (unless the ENGINEER allows an additional period of time for the submission of additional or more accurate data in support of the claim) and shall be accompanied by the CONTRACTOR's written statement that the adjustment claimed is the entire adjustment to which the CONTRACTOR is entitled as a result of said event. All claims for adjustment in the Contract Times will be determined by the ENGINEER. No claim for an adjustment in the Contract Times will be valid if not submitted in accordance with the requirements of this Paragraph 12.1 A. An increase in Contract Times does not mean that the CONTRACTOR is due an increase in Contract Price. Only compensable time extensions will result in an increase in Contract Price.
- B. All time limits stated in the Contract Documents are of the essence of the Agreement.
- C. When CONTRACTOR is prevented from completing any part of the WORK within the Contract Times (or Milestones) due to delay beyond the control of CONTRACTOR, the Contract Times (or Milestones) will be extended in an amount equal to the time lost on the critical path of the WORK due to such delay, if a claim is made therefor as provided in Paragraph 12.1.A. Delays beyond the control of CONTRACTOR shall include, but not be limited to, acts or neglect by CITY; acts or neglect of those performing other work as contemplated by Article 7; and fires, floods, epidemics, abnormal weather conditions, or acts of God. Delays attributable to and within the control of any Subcontractor or Supplier shall be deemed to be delays within the control of the CONTRACTOR.
- D. In no event will CITY be liable to CONTRACTOR, any Subcontractor, any Supplier, any other person or organization, or to any surety for or employee or agent of any of them, for any increase in the Contract Price or other damages arising out of or resulting from the following:
1. Delays caused by or within the control of CONTRACTOR; or
  2. Delays beyond the control of both CITY and CONTRACTOR including but not limited to fires, floods, epidemics, abnormal weather conditions, acts of God, or acts or neglect by those performing other work as contemplated by Article 7.

## 12.2 EXTENSIONS OF CONTRACT TIMES FOR DELAY DUE TO WEATHER

- A. The CONTRACTOR's construction schedule shall anticipate delay due to unusually severe weather. The number of days of anticipated delay is set forth in the Supplementary General Conditions.
- B. Contract Times may be extended by the ENGINEER because of delays in excess of the anticipated delay. The CONTRACTOR shall, within 10 days of the beginning of any such delay, notify the ENGINEER in writing and request an extension of Contract Times. The ENGINEER will ascertain the facts and the extent of the delay and extend the Contract Times when, in its judgment, the findings of the fact justify such an extension.

## **ARTICLE 13 – INSPECTIONS AND TESTS; CORRECTION, REMOVAL, OR ACCEPTANCE OF DEFECTIVE WORK**

### 13.1 NOTICE OF DEFECTIVE WORK

- A. Prompt notice of Defective Work known to the ENGINEER will be given to the CONTRACTOR. All Defective Work, whether or not in place, may be rejected, corrected, or accepted as provided in this Article 13. Defective Work may be rejected even if approved by prior inspection.

### 13.2 ACCESS TO WORK

- A. ENGINEER and other representatives and personnel of CITY, independent testing laboratories, and governmental agencies with jurisdictional interests shall have access to the WORK at reasonable times for their observation, inspecting, and testing. CONTRACTOR shall provide them proper and safe conditions for such access and advise them of CONTRACTOR's Site safety procedures and programs so that they may comply therewith as applicable.

### 13.3 INSPECTIONS AND TESTS

- A. The CONTRACTOR shall give the ENGINEER not less than 24 hours notice of readiness of the WORK for all required inspections, tests, or approvals, and shall cooperate with inspection and testing personnel to facilitate required inspections or tests.
- B. The CITY shall employ and pay for the services of an independent testing laboratory to perform all inspections, tests, or approvals required by the Contract Documents except:
  - 1. For inspection, tests, or approvals covered by Paragraphs 13.3C. and 13.3D. below;

2. That costs incurred in connection with tests or inspections conducted pursuant to Paragraph 13.3G. shall be paid as provided in said Paragraph 13.3G.; and
  3. As otherwise provided in the Contract Documents.
- C. If Laws and Regulations of any public body having jurisdiction require any WORK (or any part thereof) to be inspected, tested, or approved by an employee or other representative of such public body, CONTRACTOR shall assume full responsibility for arranging and obtaining such inspections, tests or approvals; pay all costs in connection therewith; and furnish the ENGINEER the required certificates of inspection or approval.
- D. The CONTRACTOR shall be responsible for arranging and obtaining and shall pay all costs in connection with any inspections, tests, or approvals required for the ENGINEER's acceptance of materials or equipment to be incorporated in the WORK or acceptance of materials, mix designs, or equipment submitted for approval prior to the CONTRACTOR's purchase thereof for incorporation in the WORK. Such inspections, tests, or approvals shall be performed by organizations acceptable to the ENGINEER.
- E. The ENGINEER will make, or have made, such inspections and tests as the ENGINEER deems necessary to see that the WORK is being accomplished in accordance with the requirements of the Contract Documents. Unless otherwise specified in any Supplementary General Conditions, the cost of such inspection and testing will be borne by the CITY. In the event such inspections or tests reveal non-compliance with the requirements of the Contract Documents, the CONTRACTOR shall bear the cost of corrective measures deemed necessary by the ENGINEER, as well as the cost of subsequent reinspection and retesting. Neither observations by the ENGINEER nor inspections, tests, or approvals by others shall relieve the CONTRACTOR from the CONTRACTOR's obligation to perform the WORK in accordance with the Contract Documents.
- F. If any WORK (including the work of others) that is to be inspected, tested, or approved is covered without written concurrence of the ENGINEER, it must, if requested by the ENGINEER, be uncovered for observation. Such uncovering shall be at the CONTRACTOR's expense unless the CONTRACTOR has given the ENGINEER not less than 24 hours notice of the CONTRACTOR's intention to perform such test or to cover the same and the ENGINEER has not acted with reasonable promptness in response to such notice.
- G. If any WORK is covered contrary to the written request of the ENGINEER, it must, if requested by the ENGINEER, be uncovered for the ENGINEER's observation and recovered at the CONTRACTOR's expense.

- H. If the ENGINEER considers it necessary or advisable that covered WORK be observed by the ENGINEER or inspected or tested by others, the CONTRACTOR, at the ENGINEER's request shall uncover, expose, or otherwise make available for observation, inspection, or testing as the ENGINEER may require, that portion of the WORK in question, furnishing all necessary labor, material, and equipment. If it is found that such work is Defective Work, the CONTRACTOR shall bear all direct, indirect, and consequential costs and damages of such uncovering, exposure, observation, inspection, and testing and of satisfactory reconstruction, including but not limited to, fees and charges of engineers, architects, attorneys, and other professionals. However, if such work is not found to be Defective Work, the CONTRACTOR will be allowed an increase in the Contract Price or an extension of the Contract Time, or both, directly attributable to such uncovering, exposure, observation, inspection, testing, and reconstruction; and, if the parties are unable to agree as to the amount or extent thereof, the CONTRACTOR may make a claim therefor as provided in Articles 11 and 12.
- I. No acceptance of equipment, materials, or work shall be construed to result from such inspections by the ENGINEER. Any inspections or tests or waivers thereof shall not relieve the CONTRACTOR of its responsibility for meeting the requirement of the Contract.

#### 13.4 CITY MAY STOP THE WORK

- A. If Defective Work is identified, the ENGINEER may order the CONTRACTOR to stop performance of the WORK, or any portion thereof, until the cause for such order has been eliminated; however, this right of the ENGINEER to stop the WORK shall not give rise to any duty on the part of the ENGINEER to exercise this right for the benefit of the CONTRACTOR or any other party.

#### 13.5 CORRECTION OR REMOVAL OF DEFECTIVE WORK

- A. If required by the ENGINEER, the CONTRACTOR shall promptly either correct all Defective Work, whether or not fabricated, installed, or completed, or, if the work has been rejected by the ENGINEER, remove it from the Site and replace it with non-defective WORK. The CONTRACTOR shall bear all direct, indirect, and consequential costs and damages of such correction or removal, including but not limited to fees and charges of engineers, architects, attorneys, and other professionals made necessary thereby.

#### 13.6 ACCEPTANCE OF DEFECTIVE WORK

- A. If, instead of requiring correction or removal and replacement of Defective Work, the CITY prefers to accept the Defective Work, the CITY may do so. The CONTRACTOR shall bear all direct, indirect, and consequential costs attributable to the CITY's evaluation of and determination to accept such Defective Work. If



any such acceptance occurs prior to final payment, a Change Order will be issued incorporating the necessary revisions in the Contract Documents with respect to the WORK, and the CITY shall be entitled to an appropriate decrease in the Contract Price.

### 13.7 CITY MAY CORRECT DEFECTIVE WORK

- A. If the CONTRACTOR fails within a reasonable time after written notice from the ENGINEER to correct Defective Work, or to remove and replace Defective Work as required by the ENGINEER in accordance with Paragraph 13.5A., or if the CONTRACTOR fails to perform the WORK in accordance with the Contract Documents, or if the CONTRACTOR fails to comply with any other provision of the Contract Documents, the CITY may, after seven days written notice to the CONTRACTOR, correct and remedy any such deficiency.
- B. In exercising the rights and remedies under this paragraph, the CITY shall proceed with corrective and remedial action. In connection with such corrective and remedial action, the CITY may exclude the CONTRACTOR from all or part of the Site, take possession of all or part of the WORK, and suspend the CONTRACTOR's services related thereto and incorporate in the WORK all materials and equipment for which the CITY has paid the CONTRACTOR whether stored at the Site or elsewhere. The CONTRACTOR shall provide the CITY and its ENGINEER, access to the Site to enable CITY to exercise the rights and remedies under this paragraph.
- C. All direct, indirect, and consequential cost and damages incurred by the CITY in exercising the rights and remedies under this paragraph will be charged against the CONTRACTOR and a Change Order will be issued incorporating the necessary revisions in the Contract Documents with respect to the WORK; and the CITY shall be entitled to an appropriate decrease in the Contract Price. If the parties are unable to agree as to the amount of the adjustment, the CITY may make a claim therefor as provided in Article 11. Such claim will include, but not be limited to, all costs of repair or replacement of work of others, destroyed or damaged by correction, removal, or replacement of CONTRACTOR's Defective Work and all direct, indirect, and consequential damages associated therewith.
- D. The CONTRACTOR shall not be allowed an extension of Contract Times (or Milestones) because of any delay in the performance of the WORK attributable to the exercise by CITY of CITY's rights and remedies under this paragraph.

### 13.8 CORRECTION PERIOD

- A. The correction period for Defective Work shall be the longer of:
  - 1. One year after the date of final acceptance;

2. Such time as may be prescribed by Laws and Regulations;
  3. Such time as specified by the terms of any applicable special guarantee required by the Contract Documents; or
  4. Such time as specified by any specific provision of the Contract Documents.
- B. If, during the correction period as defined in Paragraph 13.8A above, any work is found to be Defective Work, the CITY shall have the same remedies as set forth in Paragraphs 13.5, 13.6, and 3.7 above.
- C. Where Defective Work (and damage to other work resulting therefrom) has been corrected, removed, or replaced under this paragraph, the correction period hereunder with respect to such work will be extended for an additional period of one year after such correction or removal and replacement has been satisfactorily completed.

## **ARTICLE 14 – PAYMENTS TO CONTRACTOR AND COMPLETION**

### **14.1 SCHEDULE OF VALUES (LUMP SUM PRICE BREAKDOWN)**

- A. The schedule of values or lump sum price breakdown established as provided in the General Requirements shall serve as the basis for progress payments and shall be incorporated into a form of “Application for Payment acceptable to the ENGINEER.

### **14.2 UNIT PRICE BID SCHEDULE**

- A. Progress payments on account of unit price work will be based on the number of units completed.

### **14.3 APPLICATION FOR PROGRESS PAYMENT**

- A. Unless otherwise prescribed by law, on the 25th of each month, the CONTRACTOR shall submit to the ENGINEER for review, the Application for Payment filled out and signed by the CONTRACTOR covering the WORK completed as of the Application for Payment and accompanied by such supporting documentation as is required by the Contract Documents.
- B. The Application for Payment shall identify, as a subtotal, the amount of the CONTRACTOR total earnings to date; plus the value of materials stored at the Site which have not yet been incorporated in the WORK; and less a deductive adjustment for materials installed which were not previously incorporated in the WORK, but for which payment was allowed under the provisions for payment for materials stored at the Site, but not yet incorporated in the WORK.

- C. The net payment due the CONTRACTOR shall be the above-mentioned subtotal from which shall be deducted the amount of retainage specified in the Supplementary General Conditions and the total amount of all previous payments made to the CONTRACTOR.
- D. The value of materials stored at the Site shall be an amount equal to the specified percent of the value of such materials as set forth in any Supplementary General Conditions. Said amount shall be based upon the value of all acceptable materials and equipment not incorporated in the WORK but delivered and suitably stored at the Site or at another location agreed to in writing; provided, each such individual item has a value of more than \$5,000 and will become a permanent part of the WORK. The Application for Payment shall also be accompanied by a bill of sale, invoice, or other documentation warranting that the CONTRACTOR has received the materials and equipment free and clear of all Liens and evidence that the materials and equipment are covered by appropriate property insurance and other arrangements to protect the CITY's interest therein, all of which will be satisfactory to the CITY.
- E. A ten percent (10%) retention of payment amount shall be held by the CITY from the amount of each Application for Payment.
- F. **OPTIONAL:** Partial payments for mobilization/demobilization costs shall be as follows:
  - 1. Thirty-five percent (35%) of the amount bid for mobilization/demobilization or 1.75 percent of the original Contract Price, whichever is less, shall be paid in each of the first two progress payments.
  - 2. The balance of the amount bid for mobilization/demobilization shall be paid upon completion of all WORK on the project.

#### 14.4 CONTRACTOR'S WARRANTY OF TITLE

- A. The CONTRACTOR warrants and guarantees that title to all WORK, materials, and equipment covered by an Application for Payment, whether incorporated in the WORK or not, will pass to the CITY no later than the time of payment, free and clear of all Liens.

#### 14.5 REVIEW OF APPLICATIONS FOR PROGRESS PAYMENT

- A. The ENGINEER will, within 7 days after receipt of each Application for Payment, either indicate in writing a recommendation of payment and present the application to the CITY, or return the application to the CONTRACTOR indicating in writing the ENGINEER'S REASONS FOR REFUSING TO RECOMMEND PAYMENT. In the latter case, the CONTRACTOR may make

the necessary corrections and resubmit the application. If the ENGINEER still disagrees with a portion of the application, it will submit the application recommending the undisputed portion of the application to the CITY for payment and provide reasons for recommending non-payment of the disputed amount. Thirty days after presentation of the Application for Payment with the ENGINEER'S recommendation, the amount recommended will (subject to the provisions of Paragraph 14.5B.) become due and when due will be paid by the CITY to the CONTRACTOR.

- B. The ENGINEER, in its discretion, may refuse to recommend the whole or any part of any payment. ENGINEER may also refuse to recommend any such payment, or, because of subsequently discovered evidence or the results of subsequent inspections or tests, nullify any such payment previously recommended, to such extent as may be necessary in ENGINEER's opinion to protect CITY from loss because:
1. The work is Defective Work or the completed WORK has been damaged requiring correction or replacement.
  2. The Contract Price has been reduced by written amendment or Change Order.
  3. The CITY has been required to correct Defective Work or complete WORK in accordance with Paragraph 13.7.
  4. ENGINEER has actual knowledge of the occurrence of any of the events enumerated in Paragraph 15.1 through 15.4 inclusive.
  5. Third party claims filed or reasonable evidence indicating probable filing of such claims; or
  6. Failure of the Contractor to make payments properly to subcontractors or for labor, materials, or equipment; or
  7. Reasonable evidence that the work cannot be completed for the unpaid balance of the contract sum; or
  8. Failure of the Contractor to submit an acceptable construction schedule or failure to update the schedule; or
  9. Damage to the City or another contractor; or
  10. Reasonable evidence that the work will not be completed within the time provided for in the Contract; or

11. Contractor's failure or inability to obtain or maintain insurance coverage and bonds as required by the Contract throughout the course of the job; or
  12. Persistent failure to carry out the work in accordance with the Contract; or
  13. Failure to deliver copies of certified payrolls, as specified in Section 17.11, General Conditions.
  14. In addition, the City may deduct from any such payments due the Contractor any amounts the City may be currently or in the future authorized to retain pursuant to federal, state, or local laws or regulations, any amounts due the City from the Contractor, and any other amounts which the City is otherwise authorized to retain as specified in Special Provisions.
- C. The CITY may refuse to make payment of the full amount recommended by the ENGINEER because:
1. Claims have been made against CITY on account of CONTRACTOR's performance or furnishing of the WORK.
  2. Liens have been filed in connection with the WORK, except where CONTRACTOR has delivered a specific Bond satisfactory to CITY to secure the satisfaction and discharge of such Liens.
  3. There are other items entitling CITY to set-off against the amount recommended, or
  4. CITY has actual knowledge of the occurrence of any of the events enumerated in Paragraphs 14.5B. through 14.5C and 15.1 through 15.4 inclusive.

The CITY must give the CONTRACTOR immediate written notice stating the reasons for such action and promptly pay the CONTRACTOR the amount so withheld, or any adjustment thereto agreed to by CITY and CONTRACTOR, when CONTRACTOR corrects to CITY's satisfaction the reasons for such action.

#### 14.6 COMPLETION

- A. When the CONTRACTOR considers the WORK ready for its intended use, the CONTRACTOR shall notify the ENGINEER in writing that the WORK is complete. The CONTRACTOR shall attach to this request a list of all work items that remain to be completed and a request that the ENGINEER prepare a Notice of Completion. Within a reasonable time thereafter, the CONTRACTOR, and the ENGINEER shall make an inspection of the WORK to determine the status of completion. If the ENGINEER considers the WORK complete, the ENGINEER

will prepare and execute and deliver for City Council approval and recordation the Notice of Completion signed by the ENGINEER and CONTRACTOR, which shall fix the date of completion.

#### 14.7 PARTIAL UTILIZATION

- A. The CITY shall have the right to utilize or place into service any item of equipment or other usable portion of the WORK prior to completion of the WORK. Whenever the CITY plans to exercise said right, the CONTRACTOR will be notified in writing by the ENGINEER, identifying the specific portion or portions of the WORK to be so utilized or otherwise placed into service.
- B. It shall be understood by the CONTRACTOR that until such written notification is issued, all responsibility for care and maintenance of all of the WORK shall be borne by the CONTRACTOR. Upon issuance of said written notice of Partial Utilization, the CITY will accept responsibility for the protection and maintenance of all such items or portions of the WORK described in the written notice.
- C. The CONTRACTOR shall retain full responsibility for satisfactory completion of the WORK, regardless of whether a portion thereof has been partially utilized by the CITY prior to completion of the WORK.

#### 14.8 FINAL APPLICATION FOR PAYMENT

- A. After the CONTRACTOR has completed all of the remaining work items referred to in Paragraph 14.6 and delivered all maintenance and operating instructions, schedules, guarantees, Bonds, certificates of inspection, marked-up record documents (as provided in the General Requirements), and other documents, all as required by the Contract Documents, and after the ENGINEER has indicated that the WORK is acceptable, the CONTRACTOR may make application for final payment following the procedure for progress payments. The final Application for Payment shall be accompanied by all documentation called for in the Contract Documents, together with complete and legally effective releases or waivers (satisfactory to the CITY) of all Liens arising out of or filed in connection with the WORK.

#### 14.9 FINAL PAYMENT AND ACCEPTANCE

- A. If, on the basis of the ENGINEER's observation of the WORK during construction and final inspection, and the ENGINEER's review of the final Application for Payment and accompanying documentation, all as required by the Contract Documents, the ENGINEER is satisfied that the WORK has been completed and the CONTRACTOR's other obligations under the Contract Documents have been fulfilled, the ENGINEER will, within 14 days after receipt

of the final Application for Payment, indicate in writing the ENGINEER's recommendation of payment and present the application to the CITY for payment.

- B. After acceptance of the WORK by the City Council, the CITY will make final payment to the CONTRACTOR of the amount remaining after deducting all prior payments and all amounts to be kept or retained under the provisions of the Contract Documents, including the following items:
1. Liquidated damages, as applicable;
  2. Amounts withheld by CITY under Paragraph 14.5B. and C. which have not been released; and
  3. In accordance with Section 17.6, one-and-one-half times the value of outstanding items of correction work or punch list items yet uncompleted or uncorrected, as applicable. All such work shall be completed or corrected to the satisfaction of the ENGINEER as required by the Contract Documents, otherwise the CONTRACTOR does hereby waive any and all claims to all monies withheld by the CITY to cover the value of all such uncompleted or uncorrected items.
- C. Prior to final payment by the CITY, the CONTRACTOR must provide the CITY a fully-executed Conditional Waiver and Release Upon Final Payment in accordance with California Civil Code Section 3262.

## **ARTICLE 15 – SUSPENSION OF WORK AND TERMINATION**

### **15.1 SUSPENSION OF WORK BY CITY**

- A. The CITY may, at any time and without cause, suspend the WORK or any portion thereof for a period of not more than 90 days by notice in writing to the CONTRACTOR. The CONTRACTOR shall resume the WORK on receipt of a notice of resumption of work. The CONTRACTOR will be allowed an increase in the Contract Price or an extension of the Contract Time, or both directly attributable to any suspension if the CONTRACTOR makes an approval claim therefor as provided in Articles 11 and 12.

### **15.2 TERMINATION OF AGREEMENT BY ENGINEER FOR DEFAULT**

- A. In the event of default by the CONTRACTOR, the ENGINEER may give seven days written notice to the CONTRACTOR and the CONTRACTOR's surety of CITY's intent to terminate the Agreement and provide the CONTRACTOR an opportunity to remedy the conditions constituting the default within a specified period of time. It will be considered a default by the CONTRACTOR whenever CONTRACTOR shall:
1. Declare bankruptcy, become insolvent, or assign its assets for the benefit of its creditors;
  2. Disregard or violate the Laws or Regulations of any public body having jurisdiction;
  3. Fail to provide materials or workmanship meeting the requirements of the Contract Documents;
  4. Disregard or violate provisions of the Contract Documents or ENGINEER's instructions;
  5. Fail to prosecute the WORK according to the approved progress schedule;
  6. Fail to provide a qualified superintendent, competent workmen, or materials or equipment meeting the requirements of the Contract Documents;
  7. Disregard the authority of the ENGINEER; or
  8. Assign or subcontract any part of the work without the ENGINEER's consent.
- B. If the CONTRACTOR fails to remedy the conditions constituting default within the time allowed, the ENGINEER may then issue the notice of termination.



- C. In the event the Agreement is terminated in accordance with Paragraph 15.2A., herein, the CITY may take possession of the WORK and may complete the WORK by whatever method or means the CITY may select. The cost of completing the WORK will be deducted from the balance which would have been due the CONTRACTOR had the Agreement not been terminated and the WORK completed in accordance with the Contract Documents. If such cost exceeds the balance which would have been due, the CONTRACTOR shall pay the excess amount to the CITY. If such cost is less than the balance which would have been due, the CONTRACTOR shall not have claim to the difference.

### 15.3 TERMINATION OF AGREEMENT BY CITY FOR CONVENIENCE

- A. Upon seven days' written notice to the CONTRACTOR, the CITY may, without cause and without prejudice to any other right or remedy of the CITY, elect to terminate the Agreement. In such case, the CONTRACTOR shall be paid (without duplication of any items):
  - 1. For completed and acceptable WORK executed in accordance with the Contract Documents, prior to the effective date of termination, including fair and reasonable sums for overhead and profit of such WORK;
  - 2. For expenses sustained prior to the effective date of termination in performing services and furnishing labor, materials, or equipment as required by the Contract Documents in connection with uncompleted WORK, plus fair and reasonable sums or overhead and profit on such expenses;
  - 3. For all reasonable claims, costs, losses, and damages incurred in settlement of terminated contracts with Subcontractors, Suppliers, and others; and
  - 4. For reasonable expenses directly attributable to termination.

CONTRACTOR shall not be paid on account of loss of anticipated profits or revenue or other economic loss arising out of or resulting from such termination.

### 15.4 TERMINATION OF AGREEMENT BY CONTRACTOR

- A. The CONTRACTOR may terminate the Agreement upon 14 days written notice to the ENGINEER whenever:
  - 1. The WORK has been suspended under the provisions of Paragraph 15.1, herein, for more than 90 consecutive days through no fault or negligence of the CONTRACTOR, and notice to resume work or to terminate the

Agreement has not been received from the ENGINEER within this time period; or

2. The CITY should fail to pay the CONTRACTOR any monies due him in accordance with the terms of the Contract Documents and within 60 days after presentation to the ENGINEER by the CONTRACTOR of a request therefor, unless within said 14-day period the CITY shall have remedied the condition upon which the payment delay was based.
- B. In the event of such termination, the CONTRACTOR shall have no claims against the CITY except for those claims specifically enumerated in Paragraph 15.3, herein, and as determined in accordance with the requirements of said paragraph.

## **ARTICLE 16 – GENERAL TERMS**

### **16.1 GIVING NOTICE**

- A. Whenever any provision of the Contract Documents requires the giving of written notice, it will be deemed to have been validly given if delivered in person to the individual or to a member of the firm or to an officer of the corporation for whom it is intended, or if delivered at or sent by registered or certified mail, postage prepaid, to the last business address known to the giver of the notice.

### **16.2 TITLE TO MATERIALS FOUND ON THE WORK**

- A. The CITY reserves the right to retain title to all soils, stone, sand, gravel, and other materials developed and obtained from excavations and other operations connected with the WORK. Unless otherwise specified in the Contract Documents, neither the CONTRACTOR nor any Subcontractor shall have any right, title, or interest in or to any such materials. The CONTRACTOR will be permitted to use in the WORK, without charge, any such materials which meet the requirements of the Contract Documents.

### **16.3 RIGHT TO AUDIT**

- A. If the CONTRACTOR submits a claim to the ENGINEER for additional compensation, the CITY shall have the right, as a condition to considering the claim, and as a basis for evaluation of the claim, and until the claim has been settled, to audit the CONTRACTOR's books to the extent they are relevant. This right shall include the right to examine books, records, documents, and other evidence and accounting procedures and practices, sufficient to discover and verify all direct and indirect costs of whatever nature claimed to have been incurred or anticipated to be incurred and for which the claim has been submitted. The right to audit shall include the right to inspect the CONTRACTOR's plant or such parts thereof, as may be or have been engaged in the performance of the WORK. The CONTRACTOR further agrees that the right to audit encompasses

all subcontracts and is binding upon Subcontractors. The rights to examine and inspect herein provided for shall be exercisable through such representatives as the CITY deems desirable during the CONTRACTOR's normal business hours at the office of the CONTRACTOR. The CONTRACTOR shall make available to the ENGINEER for auditing, all relevant accounting records and documents, and other financial data, and upon request, shall submit true copies of requested records to the ENGINEER.

#### 16.4 SURVIVAL OF OBLIGATIONS

- A. All representations, indemnifications, warranties, and guaranties made in, required by or given in accordance with the Contract Documents, as well as all continuing obligations indicated in the Contract Documents, will survive final payment, completion and acceptance of the WORK or termination or completion of the Agreement.

#### 16.5 CONTROLLING LAW

- A. This Agreement is to be governed by the law of the state in which the Project is located.

#### 16.6 SEVERABILITY

- A. If any term or provision of this Agreement is declared invalid or unenforceable by any court of lawful jurisdiction, the remaining terms and provisions of the Agreement shall not be affected thereby and shall remain in full force and effect.

#### 16.7 WAIVER

- A. The waiver by the CITY of any breach or violation of any term, covenant or condition of this Agreement or of any provision, ordinance, or law shall not be deemed to be a waiver of any other term, covenant, condition, ordinance, or law or of any subsequent breach or violation of the same or of any other term, covenant, condition, ordinance, or law. The subsequent payment of any monies or fee by the CITY which may become due hereunder shall not be deemed to be a waiver of any preceding breach or violation by CONTRACTOR or any term, covenant, condition of this Agreement or of any applicable law or ordinance.

## ARTICLE 17 – CALIFORNIA STATE REQUIREMENTS

### 17.1 STATE WAGE DETERMINATIONS

- A. As required by Section 1770 and following, of the California Labor Code, the CONTRACTOR shall pay not less than the prevailing rate of per diem wages as determined by the Director of the California Department of Industrial Relations. Copies of such prevailing rate of per diem wages available file at the office of the City Clerk, which copies shall be made available to any interested party on request. The CONTRACTOR shall post a copy of such determination at each job site.
- B. In accordance with Section 1775 of the California Labor Code, the CONTRACTOR shall, as a penalty to the CITY, forfeit not more than **\$200.00** for each calendar day or portion thereof, for each worker paid less than the prevailing rates as determined by the Director for the work or craft in which the worker is employed for any public work done under the contract by him or her or by any subcontractor under him or her.

### 17.2 WORKERS' COMPENSATION

- A. In accordance with the provisions of Section 3700 of the California Labor Code, the CONTRACTOR shall secure the payment of compensation to its employees.
- B. Prior to beginning work under the Contract, the CONTRACTOR shall sign and file with the ENGINEER the following certification:

“I am aware of the provisions of Section 3700 of the Labor Code, which require every employer to be insured against liability for workers’ compensation or to undertake self-insurance in accordance with the provisions of that code, and I will comply with such provisions before commencing the performance of the WORK of this Contract.”
- C. Notwithstanding the foregoing provisions, before the Contract is executed on behalf of the CITY, a bidder to whom a contract has been awarded shall furnish satisfactory evidence that it has secured in the manner required and provided by law the payment of workers’ compensation.

### 17.3 APPRENTICES ON PUBLIC WORKS

- A. The CONTRACTOR shall comply with all applicable provisions of Section 1777.5 of the California Labor Code relating to employment of apprentices on public works.

#### 17.4 WORKING HOURS

- A. The CONTRACTOR shall comply with all applicable provisions of Section 1810 to 1815, inclusive, of the California Labor Code relating to working hours. The CONTRACTOR shall, as a penalty to the CITY, forfeit \$25.00 for each worker employed in the execution of the Contract by the CONTRACTOR or by any subcontractor for each calendar day during which such worker is required or permitted to work more than 8 hours in any one calendar day and 40 hours in any one calendar week, unless such worker receives compensation for all hours worked in excess of 8 hours at not less than 1-1/2 times the basic rate of pay.

#### 17.5 CONTRACTOR NOT RESPONSIBLE FOR DAMAGE RESULTING FROM CERTAIN ACTS OF GOD

- A. As provided in Section 7105 of the California Public Contract Code, the CONTRACTOR shall not be responsible for the cost of repairing or restoring damage to the WORK which damage is determined to have been proximately caused by an act of God, in excess of 5 percent of the contracted amount, provided, that the WORK damaged was built in accordance with accepted and applicable building standards and the plans and specifications of the CITY. The CONTRACTOR shall obtain insurance to indemnify the CITY for any damage to the WORK caused by an act of God if the insurance premium is a separate bid item in the bidding schedule for the WORK. For purposes of this Section, the term "acts of God" shall include only the following occurrences or conditions and effects: earthquakes in excess of a magnitude of 3.5 on the Richter Scale and tidal waves.

#### 17.6 NOTICE OF COMPLETION

- A. In accordance with the Sections 3086 and 3093 of the California Civil Code, within 10 days after date of acceptance of the WORK BY THE City Council the ENGINEER will file, in the County Recorder's office, a Notice of Completion of the WORK.

#### 17.7 UNPAID CLAIMS

- A. If, at any time prior to the expiration of the period for service of a stop notice, there is served upon the CITY a stop notice as provided in Sections 3179 and 3210 of the California Civil Code, the CITY shall, until the discharge thereof, withhold from the monies under its control so much of said monies due or to become due to the CONTRACTOR under this Contract as shall be sufficient to answer the claim stated in such stop notice and to provide for the reasonable cost of any litigation thereunder; provided, that if the ENGINEER shall, in its discretion, permit CONTRACTOR to file with the ENGINEER the bond referred to in Section 3196 of the Civil Code of the State of California, said monies shall not thereafter be withheld on account of such stop notice.

## 17.8 RETAINAGE FROM MONTHLY PAYMENTS

- A. Pursuant to Section 22300 of the California Public Contract Code, the CONTRACTOR may substitute securities for any money withheld by the CITY to insure performance under the Contract. At the request and expense of the CONTRACTOR, securities equivalent to the amount withheld shall be deposited with the CITY or with a state or federally chartered bank in California as to the escrow agent, who shall return such securities to the CONTRACTOR upon satisfactory completion of the Contract.
- B. Alternatively, the CONTRACTOR may request and the CITY shall make payment of retentions earned directly to the escrow agent at the expense of the CONTRACTOR. At the expense of the CONTRACTOR, the CONTRACTOR may direct the investment of the payments into securities and the CONTRACTOR shall receive the interest earned on the investments upon the same terms provided in Section 22300 of the Public Contract Code securities deposited by the CONTRACTOR. The CONTRACTOR shall be responsible for paying all fees for the expenses incurred by the escrow agent in administering the escrow account and all expenses of the CITY. These expenses and payment terms shall be determined by the CITY's Finance Director or his/her designee and the escrow agent. Upon satisfactory completion of the Contract, the CONTRACTOR shall receive from the escrow agent all securities, interest, and payments received by the escrow agent from the CITY, pursuant to the terms of Section 22300 of the Public Contract Code. The CONTRACTOR shall pay to each subcontractor, not later than 20 days of receipt of the payment, the respective amount of interest earned, net of costs attributed to retention withheld from each subcontractor, on the amount of retention withheld to insure the performance of the CONTRACTOR.
- C. Securities eligible for investment under Section 22300 shall be limited to those listed in Section 16430 of the Government Code and to bank or savings and loan certificates of deposit, interest bearing demand deposit accounts, standby letters of credit, or any other security mutually agreed to by the CONTRACTOR and the CITY.

## 17.9 PUBLIC WORKS CONTRACTS; ASSIGNMENT TO AWARDING BODY

- A. In accordance with Section 7103.5 of the California Public Contract Code, the CONTRACTOR and Subcontractors shall conform to the following requirements. In entering into a public works contract or a subcontract to supply goods, services, or materials pursuant to a public works contract, the CONTRACTOR or subcontractor offers and agrees to assign to the CITY all rights, title, and interest in and to all causes of action it may have under Section 4 of the Clayton Act (15 U.S.C. 15) or under the Cartwright Act (Chapter 2 (commencing with Section 16700) of Part 2 of Division 7 of the Business and Professions Code), arising

from purchases of goods, services, or materials pursuant to the public works contract or the subcontract. This assignment shall be made and become effective at the time the awarding body tenders final payment to the CONTRACTOR, without further acknowledgment by the parties.

17.10 PAYROLL RECORDS; RETENTION; INSPECTION; NONCOMPLIANCE PENALTIES; RULES AND REGULATIONS

- A. In accordance with Section 1776 of the California Labor Code the CONTRACTOR and each Subcontractor shall keep an accurate payroll record, showing the name, address, social security number, work classification, straight time and overtime hours worked each day and week, and the actual per diem wages paid to each journeyman, apprentice, worker, or other employee employed by him or her in connection with the public work. Each payroll record shall contain or be verified by a written declaration that it is made under penalty of perjury, stating both of the following:
1. The information contained in the payroll record is true and correct.
  2. The employer has complied with the requirements of Sections 1771, 1811, and 1815 for any work performed by his or her employees on the public works project.
- B. The payroll records shall be certified and shall be available for inspection at all reasonable hours at the principal office of the CONTRACTOR on the following basis:
1. A certified copy of an employee's payroll record shall be made available for inspection or furnished to the employee or his or her authorized representative on request as well as submitted electronically online to the Department of Industrial Relations Labor Commissioner: <https://apps.dir.ca.gov/ecpr/DAS/AltLogin>.
  2. A certified copy of all payroll records shall be made available for inspection or furnished upon request to a representative of the body awarding the contract, the Division of Labor Standards Enforcement, and the Division of Apprenticeship Standards of the Department of Industrial Relations.
  3. A certified copy of all payroll records shall be made available upon request by the public for inspection or copies thereof made; provided, however, that a request by the public shall be made through either the body awarding the contract, the Division of Apprenticeship Standards, or the Division of Labor Standards Enforcement. If the requested payroll records have not been provided the requesting party shall, prior to being provided the records, reimburse the costs of preparation by the

CONTRACTOR, Subcontractors, and the entity through which the request was made. The public shall not be given access to the records at the principal office of the CONTRACTOR.

- C. The certified payroll records shall be on forms provided by the Division of Labor Standards Enforcement or shall contain the same information as the forms provided by the division.
- D. Any copy of records made available for inspection as copies and furnished upon request to the public or any public agency by the awarding body, the Division of Apprenticeship Standards, or the Division of Labor Standards Enforcement shall be marked or obliterated in such a manner as to prevent disclosure of an individual's name, address, and social security number. The name and address of the CONTRACTOR awarded the contract or performing the contract shall not be marked or obliterated.
- E. The CONTRACTOR shall inform the ENGINEER of the location of the records including the street address, city and county, and shall, within 5 working days, provide a notice of change of location and address.
- F. The CONTRACTOR shall have 10 days in which to comply subsequent to receipt of written notice specifying in what respects the CONTRACTOR must comply with this Section. In the event that the CONTRACTOR fails to comply within the 10-day period, he or she shall, as a penalty to the state or political subdivision on whose behalf the contract is made or awarded, forfeit twenty-five dollars (\$25.00) for each calendar day, or portion thereof, for each worker, until strict compliance is effectuated. Upon the request of the Division of Apprenticeship Standards or the Division of Labor Standards Enforcement, these penalties shall be withheld from progress payments then due. A contractor is not subject to a penalty assessment pursuant to this section due to the failure of a subcontractor to comply with this section.

#### 17.11 CULTURAL RESOURCES

- A. The CONTRACTOR's attention is directed to the provisions of the Clean Water Grant Program Bulletin 76A which augments the National Historic Preservation Act of 1966 (16 U.S.C. 470) as specified under Section 01560 - Temporary Environmental Controls, of the General Requirements.

#### 17.12 PROTECTION OF WORKERS IN TRENCH EXCAVATIONS

- A. As required by Section 6705 of the California Labor Code and in addition thereto, whenever work under the Contract involves the excavation of any trench or trenches 5 feet or more in depth, the CONTRACTOR shall submit for acceptance by the ENGINEER, to whom authority to accept has been delegated, in advance of excavation, a detailed plan showing the design of shoring, bracing, sloping, or



other provisions to be made for worker protection from the hazard of caving ground during the excavation, of such trench or trenches. If such plan varies from the shoring system standards established by the Construction Safety Orders of the Division of Occupational Safety and Health, the plan shall be prepared by a registered civil or structural engineer employed by the CONTRACTOR, and all costs therefore shall be included in the price named in the Contract for completion of the WORK as set forth in the Contract Documents. Nothing in this Section shall be deemed to allow the use of a shoring, sloping, or other protective system less effective than that required by the Construction Safety Orders. Nothing in this Section shall be construed to impose tort liability on the CITY or any of its officers, agents, representatives, or employees.

- B. Excavation shall not start until the CONTRACTOR has obtained a permit from the California Division of Industrial Safety and has posted it at the site.

#### 17.13 CONCRETE FORMS, FALSEWORK, AND SHORING

- A. The CONTRACTOR shall comply fully with the requirements of Section 1717 of the Construction Safety Orders, State of California, Department of Industrial Relations, regarding the design of concrete forms, falsework and shoring, and the inspection of same prior to placement of concrete. Where the said Section 1717 requires the services of a civil engineer registered in the State of California to approve design calculations and working drawings of the falsework or shoring system, or to inspect such system prior to placement of concrete, the CONTRACTOR shall employ a registered civil engineer for these purposes, and all costs therefore shall be included in the price named in the Contract for completion of the WORK as set forth in the Contract Documents.

#### 17.14 REMOVAL, RELOCATION, OR PROTECTION OF EXISTING UTILITIES

- A. In accordance with the provisions with the provisions of Section 4215 of the California Government Code, the CITY shall assume the responsibility for the timely removal, relocation, or protection of existing main or trunkline utility facilities located on the site of any construction project that is a subject of the Contract, if such utilities are not identified by the CITY in the plans and specifications made a part of the invitation for bids. The CITY will compensate CONTRACTOR for the costs of locating, repairing damage not due to the failure of the CONTRACTOR to exercise reasonable care, and removing or relocating such utility facilities not indicated in the plans and specifications with reasonable accuracy, and for equipment on the project necessarily idled during such work.
- B. The CONTRACTOR shall not be assessed liquidated damages for delay in completion of the project, when such delay was caused by the failure of the public agency or the owner of the utility to provide for removal or relocation of such utility facilities.

- C. Nothing herein shall be deemed to require the public agency to indicate the presence of existing service laterals or appurtenances when the presence of such utilities on the site of the construction project can be inferred from the presence of other visible facilities, such as buildings, meter and junction boxes, on or adjacent to the site of construction; provided however, nothing herein shall relieve the public agency from identifying main or trunklines in the plans and specifications.
- D. If the CONTRACTOR while performing the Contract discovers utility facilities not identified by the public agency in the Contract Documents it shall immediately notify the public agency and utility in writing.
- E. The public utility, where they are the owner, shall have the sole discretion to perform such repairs or relocation work or permit the CONTRACTOR to do such repairs or relocation work at a reasonable price.

#### 17.15 CONTRACTOR LICENSE REQUIREMENTS

- A. In accordance with Section 7028.15 of the California Business and Professions Code:
- B. It is a misdemeanor for any person to submit a bid to a public agency in order to engage in the business or act in the capacity of a contractor within this state without having a license therefor, except in any of the following cases:
  - 1. The person is particularly exempted from this chapter.
  - 2. The bid is submitted on a state project governed by Section 10164 of the Public Contract Code or any local agency project governed by Section 20103.5 of the Public Contract Code.
- C. If a person has previously been convicted of the offense described in this section, the court shall impose a fine of 20 percent of the price of the contract under which the unlicensed person performed contract work, or four thousand five hundred dollars (\$4,500), whichever is greater, or imprisonment in the county jail for not less than 10 days nor more than six months, or both.
- D. In the event the person performing the contracting work has agreed to furnish materials and labor on an hourly basis, “the price of the contract” for the purpose of this subdivision means the aggregate sum of the cost of materials and labor furnished and the cost of completing the work to be performed.
- E. This section shall not apply to a joint venture license, as required by Section 7029.1 of the California Business and Professions Code. However, at the time of making a bid as a joint venture, each person submitting the bid shall be subject to this section with respect to his or her individual licensure.

- F. This section shall not affect the right or ability of a licensed architect, land surveyor, or registered professional engineer to form joint ventures with licensed contractors to render services within the scope of their respective practices.
- G. Unless one of the foregoing exceptions applies, a bid submitted to a public agency by a contractor who is not licensed in accordance with this chapter shall be considered nonresponsive and shall be rejected by the public agency. Unless one of the foregoing exceptions applies, a local public agency shall, before awarding a contract or issuing a purchase order, verify that the contractor was properly licensed when the contractor submitted the bid. Notwithstanding any other provision of law, unless one of the foregoing exceptions applies, the registrar may issue a citation to any public officer or employee of a public entity who knowingly awards a contract or issues a purchase order to a contractor who is not licensed pursuant to this chapter. The amount of civil penalties, appeal, and finality of such citations shall be subject to Sections 7028.7 and 7028.13 inclusive of the California Business and Professions Code. Any contract awarded to, or any purchase order issued to, a contractor who is not licensed pursuant to this chapter is void.
- H. Any compliance or noncompliance with subdivision (G) of this paragraph shall not invalidate any contract or bid awarded by a public agency during which time that subdivision was in effect.
- I. A public employee or officer shall not be subject to a citation pursuant to this section if the public employee, officer, or employing agency made an inquiry to the board for the purposes of verifying the license status of any person or contractor and the board failed to respond to the inquiry within three business days. For the purposes of this section, a telephone response by the board shall be deemed sufficient.

17.16 DIGGING TRENCHES OR EXCAVATIONS; NOTICE ON DISCOVERY OF HAZARDOUS WASTE OR OTHER UNUSUAL CONDITIONS; INVESTIGATIONS; CHANGE ORDERS; EFFECT ON CONTRACT

- A. If this Contract involves digging trenches or other excavations that extend deeper than four feet below the surface, the following shall apply:
  - 1. The CONTRACTOR shall promptly, and before the following conditions are disturbed, notify the ENGINEER in writing, of any:
    - a. Material that the CONTRACTOR believes may be material that is hazardous waste, as defined in Section 25117 of the Health and Safety Code, that is required to be removed to a Class I, Class II, or Class III disposal site in accordance with provisions of existing law.

- b. Subsurface or latent physical conditions at the site differing from those indicated.
- c. Unknown physical conditions at the site of any unusual nature, different materially from those ordinarily encountered and generally recognized as inherent in work of the character provided for in the contract.
- d. The ENGINEER shall promptly investigate the conditions, and if it finds that the conditions do materially so differ, or do involve hazardous waste, and cause a decrease or increase in the CONTRACTOR'S cost of, or the time required for, performance of any part of the work shall issue a change order the procedures described in the Contract.
- e. In the event that a dispute arises between the ENGINEER and the CONTRACTOR whether the conditions materially differ, or involve hazardous waste, or cause a decrease or increase in the CONTRACTOR'S cost of, or time required for, performance of any part of the work, the CONTRACTOR shall not be excused from any scheduled completion date provided for by the Contract, but shall proceed with all work to be performed under the Contract. The CONTRACTOR shall retain any and all rights provided either by contract or by law which pertain to the resolution of disputes and protests between the contracting parties.

#### 17.17 RETENTION PROCEEDS; WITHHOLDING; DISBURSEMENT

- A. In accordance with Section 7107 of the Public Contract Code with respects to all contracts entered into on or after January 1, 1993 relating to the construction of any public work of improvement the following shall apply:
  - 1. The retention proceeds withheld from any payment by the CITY from the original CONTRACTOR, or by the original CONTRACTOR from any subcontractor, shall be subject to this paragraph 17.18.
  - 2. Within 60 days after the date of completion of the WORK, including any punch-list WORK, the retention withheld by the CITY shall be released. In the event of a dispute between the ENGINEER and the original CONTRACTOR, the CITY may withhold from the final payment an amount not to exceed 150 percent of the disputed amount. For the purposes of this paragraph, "completion" means any of the following:
    - a. The occupation, beneficial use, and enjoyment of a work of improvement, excluding any operation only for testing, startup, or

commissioning, by the CITY, accompanied by cessation of labor on the work of improvement.

- b. The acceptance by the City Council of the work of improvement.
  - c. After the commencement of a work of improvement, a cessation of labor on the work of improvement for a continuous period of 100 days or more, due to factors beyond the control of the CONTRACTOR.
  - d. After the commencement of a work of improvement, a cessation of labor on the work of improvement for a continuous period of 30 days or more, if the ENGINEER files for record a notice of cessation or a notice of completion.
3. Subject to subparagraph 17.18 A.4, within 10 days from the time that all or any portion of the retention proceeds are received by the original CONTRACTOR, the original CONTRACTOR shall pay each of its subcontractors from whom retention has been withheld, each subcontractor's share of the retention received. However, if a retention payment received by the original CONTRACTOR is specifically designated for a particular subcontractor, payment of the retention shall be made to the designated subcontractor, if the payment is consistent with the terms of the subcontract.
  4. The original CONTRACTOR may withhold from a subcontractor its portion of the retention proceeds if a bona fide dispute exists between the subcontractor and the original CONTRACTOR. The amount withheld from the retention payment shall not exceed 150 percent of the estimated value of the disputed amount.
  5. In the event that retention payments are not made within the time periods required by this paragraph 17.18, the CITY or original CONTRACTOR shall be subject to a charge of 2 percent per month on the improperly withheld amount, in lieu of any interest otherwise due. Additionally, in any action for the collection of funds wrongfully withheld, the prevailing party shall be entitled to attorney's fees and costs.
  6. Any attempted waiver of the provisions of this section shall be void as against the public policy of this state.

#### 17.18 TIMELY PROGRESS PAYMENTS; INTEREST; PAYMENT REQUESTS

- A. If the CITY fails to make any progress payment within 30 days after receipt of an undisputed and properly submitted payment request from the CONTRACTOR, the CITY shall pay interest to the CONTRACTOR equivalent to the legal rate set forth in subdivision (a) of Section 685.010 of the Code of Civil Procedure.
- B. Upon receipt of a payment request, the ENGINEER shall act in accordance with both of the following:
  - 1. Each payment request shall be reviewed by the ENGINEER as soon as practicable after receipt for the purpose of determining that the payment request is a proper payment request.
  - 2. Any payment request determined not to be a proper payment request suitable for payment shall be returned to the CONTRACTOR as soon as practicable, but not later than seven days, after receipt. A request returned pursuant to this paragraph shall be accompanied by a document setting forth in writing the reasons why the payment request is not proper.
- C. The number of days available to the CITY to make a payment without incurring interest pursuant to this paragraph shall be reduced by the number of days by which the CITY exceeds the seven-day requirement set forth above.
- D. For purposes of this paragraph:
  - 1. A “progress payment” includes all payments due the CONTRACTOR, except that portion of the final payment designated by the contract as retention earnings.
  - 2. A payment request shall be considered properly executed if funds are available for payment of the payment request, and payments is not delayed due to an audit inquiry by the financial officer of the CITY.

#### 17.19 PREFERENCE FOR MATERIAL

- A. In accordance with Section 3400 of the California Public Contract Code, the CONTRACTOR will be provided a period prior to award of the contract for submission of data substantiating a request for a substitution of “as equal” item.

17.20 RESOLUTION OF CONSTRUCTION CLAIMS

- A. In accordance with Section 20104 et Seq. of the California Public Contract Code. This paragraph applies to all claims of \$375,000 or less which arise between the CONTRACTOR and the CITY under this Contract for:
  - 1. A time extension;
  - 2. Payment of money or damages arising from work done by or on behalf of, the CONTRACTOR pursuant to this CONTRACT and payment of which is not otherwise expressly provided for or the CONTRACTOR is not otherwise entitled to; or
  - 3. An amount the payment of which is disputed by the ENGINEER.
- B. For any claim set out in Paragraphs A.1, 2, or 3 above, the following requirements apply:
  - 1. The claim shall be in writing and include the documents necessary to substantiate the claim and be accompanied by the following certification:

“CONTRACT PROVISION REQUIRING PERSONAL CERTIFICATION OF ALL CLAIMS:

I, \_\_\_\_\_, BEING THE \_\_\_\_\_ (MUST BE AN OFFICER) OF \_\_\_\_\_ (GENERAL CONTRACTOR), DECLARE UNDER PENALTY OF PERJURY UNDER THE LAWS OF THE STATE OF CALIFORNIA, AND DO PERSONALLY CERTIFY AND ATTEST THAT: I HAVE THOROUGHLY REVIEWED THE ATTACHED CLAIM FOR ADDITIONAL COMPENSATION AND/OR EXTENSION OF TIME, AND KNOW ITS CONTENTS, AND SAID CLAIM IS MADE IN GOOD FAITH; THE SUPPORTING DATA IS TRUTHFUL AND ACCURATE; THAT THE AMOUNT REQUESTED ACCURATELY REFLECTS THE CONTRACT ADJUSTMENT FOR WHICH THE CONTRACTOR BELIEVES THE CITY IS LIABLE; AND, FURTHER THAT I AM FAMILIAR WITH CALIFORNIA PENAL CODE SECTION 12650, ET SEQ. PERTAINING TO FALSE CLAIMS, AND FURTHER KNOW AND UNDERSTAND THAT SUBMISSION OR CERTIFICATION OF A FALSE CLAIM MAY LEAD TO FINES, IMPRISONMENT AND/OR OTHER SEVERE LEGAL CONSEQUENCES.”

Claims must be filed on or before the date of final payment. Nothing herein is intended to extend the time limit or supersede notice requirements otherwise provided by Contract for the filing of claims.

The claim must include an actual cost documentation, including hours of work performed, equipment operation costs, and labor and overhead costs, which should be established at a standard percentage. Any overhead costs listed when paid, shall provide full and complete payment for any and all overhead, including jobsite overhead, home office overhead, as well as additional costs arising from disruption, resequencing or acceleration. A notice of POTENTIAL CLAIM shall be submitted in advance of the performance of any work, regardless of type, in which the CONTRACTOR may claim an additional cost. CONTRACTOR shall provide prompt notification of any disagreement in quantities of work performed along with a detailed accounting by means of a schedule update demonstrating any delays incurred.

2. For claims of less than fifty thousand dollars (\$50,000), the ENGINEER shall respond in writing to any written claim within 45 days of receipt of the claim, or may request, in writing, within 30 days of receipt of the claim, any additional documentation supporting the claim or relating to defenses to the claim the CITY may have against the CONTRACTOR.

If additional information is thereafter required, it shall be requested and provided upon mutual agreement of the ENGINEER and the CONTRACTOR.

The ENGINEER's written response to the claim, as further documented, shall be submitted to the CONTRACTOR within 15 days after receipt of further documentation or within a period of time no greater than that taken by the CONTRACTOR in producing the additional information, whichever is greater.

3. For claims of over fifty thousand dollars (\$50,000) and less than or equal to three hundred seventy-five thousand dollars (\$375,000), the ENGINEER shall respond in writing to all written claims within 60 days of receipt of the claim, or may request, in writing, within 30 days of receipt of the claim, any additional documentation supporting the claim or relating to defenses to the claim the CITY may have against the CONTRACTOR.

If additional information is thereafter required, it shall be requested and provided upon mutual agreement of the ENGINEER and the CONTRACTOR.



The ENGINEER's written response to the claim, as further documented, shall be submitted to CONTRACTOR within 30 days after receipt of the further documentation, or within a period of time no greater than that taken by the CONTRACTOR in producing the additional information or requested documentation, whichever is greater.

4. If the CONTRACTOR disputes the ENGINEER's written response, or the ENGINEER fails to respond within the time prescribed, the CONTRACTOR may notify the ENGINEER, in writing, either within 15 days of receipt of the ENGINEER's response or within 15 days of the ENGINEER's failure to respond within the time prescribed, respectively, and demand an informal conference to meet and confer for settlement of the issues in dispute. Upon a demand, the ENGINEER shall schedule a meet and confer conference within 30 days for settlement of the dispute.
5. Following the meet and confer conference, if the claim or any portion remains in dispute, the CONTRACTOR may file a claim pursuant to Chapter 1 (commencing with Section 900) and Chapter 2 (commencing with Section 910) of Part 3 of Division 3.6 of Title 1 of the Government Code. For purposes of those provisions, the running of the period of time within which a claim must be filed shall be tolled from the time CONTRACTOR submits its written claim pursuant to subdivision (a) until the time the claim is denied as a result of the meet and confer process, including any period of time utilized by the meet and confer process.

C. The following procedures are established for all civil actions filed to resolve claims subject to this article:

1. Within 60 days, but no earlier than 30 days, following the filing or responsive pleadings, the court shall submit the matter to nonbinding mediation unless waived by mutual stipulation of both parties. The mediation process shall provide for the selection within 15 days by both parties of a disinterested third person as mediator, shall be commenced within 30 days of the submittal, and shall be concluded within 15 days from the commencement of the mediation unless a time requirement is extended upon a good cause showing to the court or by stipulation of both parties. If the parties fail to select a mediator within the 15-day period, any party may petition the court to appoint the mediator.
2. If the matter remains in dispute, the case shall be submitted to judicial arbitration pursuant to Chapter 2.5 (commencing with Section 1141.10) of Title 3 of Part 3 of the Code of Civil Procedure, notwithstanding Section 1141.11 of that code. The Civil Discovery Act of 1986 (Article 3 (commencing with Section 2016) of Chapter 3 of Title 3 of Part 4 of the Code of Civil Procedure) shall apply to any proceeding brought under this subdivision consistent with the rules pertaining to judicial arbitration.

Notwithstanding any other provision of law, upon stipulation of the parties, arbitrators appointed for purposes of Article 1.5 of Chapter 1 of Part 3 of Division 2 of the California Public Contract Code shall be experienced in construction law, and, upon stipulation of the parties, mediators and arbitrators shall be paid necessary and reasonable hourly rates of pay not to exceed their customary rate, and such fees and expenses shall be paid equally by the parties, except in the case of arbitration where the arbitrator, for good cause, determines a different division. In no event shall these fees or expenses be paid by state or county funds.

In addition to Chapter 2.5 (commencing with Section 1141.10 of Title 3 of Part 3 of the Code of Civil Procedure) any party who after receiving an arbitration award requests a trial de novo but does not obtain a more favorable judgment shall, in addition to payment of costs and fees under that chapter, also pay the attorney's fees of the other party arising out of the trial de novo .

3. The CITY shall not fail to pay money as to any portion of a claim which is undisputed except as otherwise provided in this Contract.
4. In any suit filed under Section 20104.4 of the California Public Contract Code, the CITY shall pay interest at the legal rate on any arbitration award or judgment. The interest shall begin to accrue on the date the suit is filed in a court of law.

#### END OF GENERAL CONDITIONS

file name:

**SECTION III**  
**SPECIAL PROVISIONS**

## SECTION III.

### SPECIAL PROVISIONS

- 3-1. DESCRIPTION OF WORK - The work to be done consists of furnishing all labor, materials, equipment and services necessary to complete the removal and replacement of concrete sidewalks, installation of new concrete sidewalks, curbs and gutters, driveways, miscellaneous concrete repairs as may be requested within the City of Petaluma. Locations as shown on the exhibits are sidewalk replacements of sections on Casa Grande Road across from the High School, sections of East Washington from Sutter to Ely, sidewalk sections around Luccesi Pond and the Boys and Girls Club on Maria. New meandering concrete sidewalk on Lakeville Road in front of the PG&E substation across from CVS, and a concrete path at 202 North McDowell Blvd. All work shall include necessary vehicular and pedestrian traffic control.

Locations shown on the exhibits are schematic and the exact locations of replacement and alignments of new sidewalks will be determined at the pre-construction meeting.

The City reserves the right to add or delete any identified work. All work performed shall be measured and paid based on the contract unit prices identified in the Bid Schedule. The unit prices shall not be subject to change based on the addition or deletion of work.

- 3-2. HOURS OF WORK

Weekdays – Weekdays (Monday through Friday) hours shall be from 8:00 a.m. to 4:30 p.m. for all required work except those hours approved by the City of Petaluma or specified in “Order of Work” Section of these special provisions.

Night Hours – Other than emergency work, there will be no night hours allowed on this project.

Liquidated Damages in the sum of Five Hundred Dollars (\$500) per day will be assessed against the CONTRACTOR if he fails to comply with any of the daily conditions or operations such as maintaining erosion control facilities, job site/street cleanliness and daily cleanup and traffic control and flagging, as described in the General Conditions, these Special Provisions, and the Technical Specifications.

If the CONTRACTOR closes a street or sidewalk without 24 hour prior notice and approval of the ENGINEER, the associated operation will be shutdown at the CONTRACTOR’s expense.

Holidays - Designated legal holidays are: January 1st, the third Monday in January, the third Monday in February, the last Monday in May, July 4th, the first Monday in September, the second Monday in October, November 11th, Thanksgiving Day, the day after Thanksgiving, December 24th and December 25th. When a designated legal holiday falls on a Sunday, the following Monday shall be a designated legal holiday. When November 11th falls on a Saturday, the preceding Friday shall be a designated

legal holiday. The Contractor shall not work on the legal holidays unless approved in writing by the Engineer.

- 3-3. ORDER OF PRECEDENCE OF CONTRACT DOCUMENTS – If the CONTRACTOR discovers any errors, omissions, discrepancies, or conflicts in the Contract, he/she shall immediately inform the ENGINEER in writing. The ENGINEER will promptly resolve such matters by issuing addenda or change orders. Failure or delay to act on the part of the ENGINEER shall not constitute a waiver of any right afforded the CITY or the ENGINEER by the Contract or constitute an implied approval. Any work affected by such discoveries that is performed by the CONTRACTOR prior to authorization by the CITY shall be at the CONTRACTOR’S risk.

Unless otherwise noted below, conflicts or inconsistencies between parts of the Contract will be resolved by the ENGINEER with a change order or an addendum, if required. Addenda and change orders bearing the most recent date shall prevail over addenda or change orders bearing earlier dates. Any reference to addenda-changed specifications or drawings shall be considered to have been changed accordingly.

In resolving conflicts, errors, or discrepancies, the order of precedence shall be as follows:

- 1) Change Orders/Addenda (most recent in time takes precedence)
- 2) Agreement and Bond Forms
- 3) Special Provisions
- 4) Technical Specifications
- 5) Referenced Standard Specifications (City, Current Caltrans Standard Specifications)
- 6) Drawings
- 7) General Conditions
- 8) Instructions to Bidders
- 9) CONTRACTOR’S Bid (Bid Form)
- 10) Notice Inviting Bids
- 11) Permits from other agencies as may be required by law.

- 3-4. COOPERATION - Attention is directed to Sections 5-1.20, "Coordination with Other Entities", and 5-1.36D, "Nonhighway Facilities", of the Standard Specifications and these special provisions.

The CONTRACTOR shall not adjust gas, electric, television cable, telephone, and Sonoma County structures. The CONTRACTOR will notify each agency who will be in turn adjust their own structures at least seven (7) working days prior to covering/burying

these facilities at no cost to the CITY. Failure to do so shall result in the CONTRACTOR being liable for the utility agencies' claims.

- 3-5. **OBSTRUCTIONS** - Attention is directed to Sections 5-1.36D, "Nonhighway Facilities", and 15, "Existing Facilities", of the Standard Specifications and these special provisions.

The CONTRACTOR's attention is directed to the existence of certain underground facilities that may require special precautions be taken by the CONTRACTOR to protect the health, safety and welfare of workmen and of the public. Facilities requiring special precautions include, but are not limited to: conductors of petroleum products, oxygen, chlorine and toxic or flammable gases; natural gas in pipelines greater than 6 inches in diameter or pipelines operating at pressures greater than 60 psi (gage); underground electric supply system conductors or cables either directly buried or in duct or conduit which do not have concentric neutral conductors or other effectively grounded metal shields or sheaths; and underground electrical conductors with potential to ground of more than 300 volts.

The CONTRACTOR shall notify the ENGINEER and the appropriate regional notification center for operators of subsurface installations at least 5 working days prior to performing any excavation or other work close to any underground pipeline, conduit, duct, wire or other structure. Regional notification centers include but are not limited to the following:

Underground Service Alert  
Northern California (USA)  
Telephone: 1 (800) 227-2600

If the CONTRACTOR's certain operation is delayed, in the opinion of the ENGINEER, by the discovery of an underground utility not indicated on the plans or not marked by USA, the CONTRACTOR shall be paid a fair and reasonable compensation for the actual loss. Actual loss shall be understood to include no items of expense other than idle time of equipment exclusively used in such operation and necessary payments for idle time of labor exclusively required for such operation only, determined as follows:

- 1) Compensation for idle equipment shall be applied at the reduced Caltrans' Equipment Rental Rates where the right of way delay factor for each classification of equipment shall be applied to such equipment rental rate. No markup shall be applied for overhead or profit.
- 2) Compensation for idle time of labor shall be actual wages paid to the workers. No markup shall be added for overhead and profit.
- 3) The time for which such compensation will be paid will not exceed eight (8) hours for each incident.
- 4) The CONTRACTOR shall be granted an extension of time for the delay.

5) No monetary compensation will be allowed for delays due to utilities indicated on the plans or marked by USA.

3-6. ORDER OF WORK – Work shall be at the digression of the contractor. 45 working days.

3-7. PROGRESS SCHEDULE – Upon receipt of a Work Order, the Contractor shall provide a work completion schedule when submitting the Work Order for Authorization. The Contractor shall complete any given work order within ten (10) working days of the commencement of work unless agreed to by City in writing. Work shall commence within five (5) working days of notification by the City unless agreed to by City in writing.

Payment for the work completion schedule shall be considered to be included in the various items of work and no additional compensation will be allowed therefor.

3-8. SUPERINTENDENCE - The CONTRACTOR shall designate in writing before starting work, an authorized representative who shall have the authority to represent and act for the CONTRACTOR for the duration of the contract. Any change in the designation shall require prior approval of the ENGINEER.

When the CONTRACTOR is comprised of two (2) or more persons, firms, partnerships or corporations functioning on a joint venture basis, said CONTRACTOR shall designate in writing before starting work, the name of one authorized representative who shall have the authority to represent and act for the CONTRACTOR.

Said authorized representative shall be available for contact to the City at all times while work is actually in progress for each work order.

If work is in progress and the authorized representative is not available for contact, the City reserves the right to stop the work at no cost to the City.

Once the work begins, the Superintendent shall keep the ENGINEER informed of the CONTRACTOR's daily schedule. The ENGINEER shall have at least twenty-four (24) hour advance notice of all work, on a daily basis, including SUBCONTRACTOR's work. If the CONTRACTOR fails to notify the ENGINEER, the ENGINEER reserves the right to stop the work at no cost to the City.

In the case of urgency or emergency where the CONTRACTOR's authorized representative is not available and where the ENGINEER wishes to give notification or direction, it will be given to and be obeyed by the superintendent or foreperson who may have charge of the particular work or it will be given to and be obeyed by any worker in the area should the superintendent or foreperson not be immediately available.

All costs involved in superintendence shall be included in the contract prices paid for various items of work and no additional payment will be allowed therefore.

3-9. WATERING - Watering shall conform to the provisions in Section 17, "Watering", of the Standard Specifications except that full compensation for developing water supply shall be considered as included in the prices paid for various contract items for work involving the use of water and no separate payment will be made therefore. The application of water for dust control will not be considered as extra work under any circumstances. Water can be purchased from the City at current rates provided that the CONTRACTOR meters the water so used with a City furnished meter (a deposit will be required) and a CONTRACTOR furnished valve assembly.

3-10. BEGINNING OF WORK, CONTRACT TIME, TIME OF COMPLETION, AND LIQUIDATED DAMAGES – Article 2.3, “Commencement of Contract Times; Notice To Proceed” of the General Conditions is amended to read:

The Utility Patch Paving and Concrete Replacement Program On-Call Contract will be for a contract period of one (1) year. The contract start date will be determined after approval of the agreement by the City. The contract period may be extended if mutually agreed upon without any formal bidding process.

For the work, the CONTRACTOR shall begin work within five (5) working days after the CONTRACTOR receives a Work Order, or at a time agreed upon by the Engineer. All contract WORK shall be diligently prosecuted to completion before the expiration of ten (10) working days from the date of starting work or as directed by the ENGINEER in the work order. The CONTRACTOR shall complete all of the work directed by the ENGINEER in all parts and requirements within the time set forth. A working day is defined in these special provisions.

Upon 75 percent of the completed work per the bid schedule, and with proof of payment of all sub-contractor and material suppliers, the City will release 50 percent of the retention amount.

The CONTRACTOR is on notice that it may take approximately eight (8) weeks from the bid opening to obtain the City Council’s award of the contract, to process the construction agreement, and to issue the Notice of Award.

**The CONTRACTOR shall pay to the City of Petaluma the sum of \$200 per day for each and every *calendar days* delay in finishing the work in excess of the number of days prescribed above (and/or in excess of the number of days prescribed for any scheduled operations or works described in these Special Provisions).**

A working day is defined as any day, except as follows:

- a. Saturdays, Sundays, and legal holidays
- b. Days on which the CONTRACTOR is prevented by inclement weather or conditions resulting immediately therefrom adverse to the current controlling operation or operations, as determined by the ENGINEER, from proceeding with at least 75 percent of the normal labor and equipment force engaged on that



operation or operations for at least 60 percent of the total daily time being currently spent on the controlling operation or operations.

Should the CONTRACTOR prepare to begin work at the regular starting time of any day on which inclement weather, or the conditions resulting from the weather, or the condition of the work, prevents the work from beginning at the usual starting time and the crew is dismissed as a result thereof and the CONTRACTOR does not proceed with at least 75 percent of the normal labor and equipment force engaged in the current controlling operation or operations for at least 60 percent of the total daily time being currently spent on the controlling operation or operations, the CONTRACTOR will not be charged for a working day whether or not conditions should change thereafter during that day and the major portion of the day could be considered to be suitable for those construction operations.

Determination that a day is a non-working day by reason of inclement weather or conditions resulting immediately therefrom shall be made by the ENGINEER. The CONTRACTOR will be allowed 10 days from the issuance of the weekly statement of working days in which to file a written protest setting forth in what respects the CONTRACTOR differs from the ENGINEER; otherwise, the decision of the ENGINEER shall be deemed to have been accepted by the CONTRACTOR as correct. The ENGINEER will furnish the CONTRACTOR a weekly statement showing the number of working days charged to the contract for the preceding week, the number of working days of time extensions being considered or approved, the number of working days originally specified for the completion of the contract, and the number of working days remaining to complete the contract and any time extensions thereof.

3-11. ORDER OF WORK – Each or any direction from the ENGINEER will specify the order of WORK needed.

3-12. SAFETY REQUIREMENT - The CONTRACTOR shall comply with all CAL/OSHA safety requirements. It shall be the CONTRACTOR's sole responsibility for making sure these safety requirements are met and the CONTRACTOR shall fully assume all liabilities for any damages and/or injuries resulting from his or her failure to comply with the safety requirements. Failure on the City's part to stop unsafe practices shall, in no way, relieve the CONTRACTOR of his/her responsibility.

The CONTRACTOR shall first call City of Petaluma Emergency Center at 911, from a regular telephone, and (707) 762-2727 or (707) 762-4545 from a cellular phone, if any gas lines or electrical power lines are broken or damaged.

3-13. PROJECT APPEARANCE – The CONTRACTOR shall maintain a neat appearance to the work area.

When practicable, debris developed during construction shall be disposed of concurrently with its removal. Stockpiling on the street shall not be allowed. The CONTRACTOR shall apply for a “stockpiling” permit from the City’s Community Development Department prior to stockpiling more than fifty (50) cubic yards of materials on private

property. The CONTRACTOR shall solely be responsible for securing staging and/or stockpiling areas.

The CONTRACTOR shall provide dust control as often as required during the construction, and shall clean the roads/streets with street sweepers at least once a day at the end of each working day or more often if safety or appearance conditions warrant. Failure to maintain dust control, street cleaning and/or any required work specified in this section shall result in the City performing the work with other forces and back charge the CONTRACTOR for the costs.

Full compensation for conforming to the provisions in this section, not otherwise provided for, shall be considered as included in prices paid for the various contract items of work involved and no additional compensation will be allowed therefore.

- 3-14. RESPONSIBILITY FOR DAMAGE - The CONTRACTOR shall indemnify, hold harmless, release and defend the City of Petaluma, its officers, officials, employees and agents from and against any and all liabilities, claims, demands, losses, damages, expenses, costs (including without limitation costs and fees of litigation) of every nature arising out of or in connection with the activities of the CONTRACTOR, his/her subcontractors, employees and agents, except such loss or damage which was caused by the sole negligence or willful misconduct of the CITY, its employees or agents. The CITY may retain so much of the money due the CONTRACTOR as shall be considered necessary, until disposition has been made of claims or suits for damages as aforesaid.
- 3-15. GUARANTEE OF WORK - Neither the final certificate of payment nor any provision in the contract nor partial or entire use of the improvements embraced in this contract by the City or the public shall constitute an acceptance of work not done in accordance with the contract or relieve the CONTRACTOR of liability in respect to any warranties or responsibility for faulty materials or workmanship. The CONTRACTOR's attention is directed to Article 5, "Bonds and Insurance", of the General Conditions.
- 3-16. PERMIT – The Contractor shall be responsible for obtaining permits from other agencies (i.e. SMART etc.), if required prior to commencement of any work.
- 3-17. WAGE RATES - The General Prevailing Wage Determination Made by the Director of Industrial Relations Pursuant to California Labor Code Part 7, Chapter 1, Article 2, Sections 1770, 1773 and 1773.2. The CONTRACTOR can download this information from the web site: <http://www.dir.ca.gov/dlsr/PWD/>

The most current prevailing wage rates available at the time of bid opening shall be used.

- 3-18. ITEM INCREASES AND DECREASES -

#### **Increased or Decreased Quantities**

The total bid quantities shown for the various items on the Bid Schedule are an estimate of the work expected to be done by the contractor over the period of the contract time.

This in an On-Call contract, the CONTRACTOR will receive work orders on an as needed basis. There will be no guarantee that the work required will equal that of the ENGINEER's Estimate. There will be no adjustment in contract unit price for any variations in the estimated bid quantities.

The CONTRACTOR will provide a separate invoice to the City for each work order. The total cost of each invoice will be determined by the contract unit prices.

- 3-19. MAINTAINING TRAFFIC – Attention is directed to Sections 7-1.03, “Public Convenience”, 7-1.04, “Public Safety”, and 12, “Temporary Traffic Control”, of the Standard Specifications and the City of Petaluma Traffic Control Design and Construction Standards Series 700. Nothing in these special provisions shall be construed as relieving the CONTRACTOR from his/her responsibility as provided in said Section 7-1.04.

Lane closures shall conform to the provisions in the section of these special provisions entitled, “Traffic Control System for Lane Closure.”

The Contractor will minimize disruption to all traffic (vehicular, transit, bicycle, and pedestrians) during the allowed work window. During construction, bicyclists will either share the road with vehicular traffic in a signed detour or be provided separate access. In addition, pedestrian access will be maintained at all times during construction. The Contractor shall provide temporary pedestrian curb ramps and clearly mark the temporary crosswalks. The pedestrian path shall be clear of any debris and meet ADA requirements. Driveway access to schools, residents, and businesses will also be maintained at all times.

At least 72 hours prior to beginning of each phase of construction (i.e., piping installation, paving, pavement repair, concrete construction, etc.), the CONTRACTOR shall:

- A. Notify all adjacent residents, businesses, City of Petaluma Police and Fire, Green Waste Recovery (residential refuse service company), Waste Management Company (industrial refuse service company), and Petaluma Transit by written notices detailing the type, limits, date and the hours of work. Details of the notice shall be submitted to the ENGINEER for review and approval at least five (5) days prior to delivering these notices.
- B. Where required, post streets with temporary "No Parking/Tow Away" signs at 100-foot intervals at least 72 hours in advance. These signs shall be furnished by the CONTRACTOR and shall state the date; day of week and hour parking is prohibited.

Illuminated traffic cones when used during the hours of darkness shall be affixed or covered with reflective cone sleeves as specified in Section 12-3.10, "Traffic Cones", of the Standard Specifications.

Full compensation for temporary delineation shall be considered as included in the prices paid for the contract in terms of work which obliterated the existing delineation and no separate payment will be made therefore.

When working in or blocking any intersection, the CONTRACTOR shall provide flag persons to direct traffic at that intersection. This is in addition to other required flag persons.

Personal vehicles of the CONTRACTOR's employees shall not be parked on the traveled way, including any section closed to public traffic unless permitted by the ENGINEER. The CONTRACTOR, at all times, shall provide flag person(s) to direct delivery trucks and CONTRACTOR's vehicles entering or leaving the public traffic.

Whenever vehicles or equipment are parked on the shoulder within 6 feet of a traffic lane, the shoulder area shall be closed with fluorescent traffic cones or portable delineators placed on a taper in advance of the parked vehicles or equipment and along the edge of the pavement at 25-foot intervals to a point not less than 25 feet past the last vehicle or piece of equipment. A minimum of 9 cones or portable delineators shall be used for the taper. A C23 (Road Work Ahead) or C24 (Shoulder Work Ahead) sign shall be mounted on a telescoping flag tree with flags. The flag tree shall be placed where directed by the ENGINEER.

A minimum of one (paved) reversible traffic lane, not less than 10 feet wide, shall be open for use by public traffic in with minimal delays, flaggers, adequate traffic control, and signing. ***Flashing arrow boards shall be required for any lane closures.***

Day work: No work and/or preparation of work shall be performed between 5:00 p.m. and 7:00 a.m. unless approved by the ENGINEER in writing, except work required under said Sections 7-1.03 and 7-1.04 of the Standard Specifications or specified elsewhere in the special provisions.

Except as otherwise provided, the full width of the traveled way shall be open for use by public traffic on Saturdays, Sundays, after 4:00 p.m. on Fridays, on designated legal holidays, during the holiday shutdown period (in applicable areas), and when construction operations are not actively in progress.

Designated legal holidays and the holiday shutdown period are outlined in "Hours of Work" of these Special Provisions.

Minor deviations from the requirements of this section concerning hours of work which do not significantly change the cost of the work may be permitted upon the written request of the CONTRACTOR if in the opinion of the ENGINEER public traffic will be better served and the work expedited. Such deviations shall not be adopted until the ENGINEER has indicated his/her written approval. All other modifications will be made by contract change order.

Prior to commencing construction which will affect existing traffic, the contractor shall submit for review by the Engineer, a Traffic Control Plan on 11"x17" or 22"x34" sheet(s) of paper which contains only information specially related to work zone traffic control. If the Contractor proposes to use the latest edition of California Department of Transportation Manual of Traffic Controls for Construction and Maintenance of Work Zones in lieu of a traffic control plan, in specific work operations, he/she shall submit in writing for consideration which Typical Application Diagram will be used for each work operation. A Traffic Control Plan or proposal shall be submitted for review **at least** 48 hours prior to implementation.

In addition to the traffic control plan, the Contractor shall submit a haul route for approval by the Engineer. The route must minimize traffic on residential streets that are not part of the project. Temporary staging of construction materials shall not occur on streets or areas that are not within the immediate limits of the project.

The Traffic Control Plan shall contain a title block which contains the contractor's name, address, phone number, project superintendent's name, contract name, dates and hours traffic control will be in effect, and a space for review acknowledgement by the City.

The content of the Traffic Control Plan shall include, but not limited to, the following:

- A. Show location and limits of the work zone for each phase or specific operation of construction if requiring different traffic control.
- B. Give dimensions of lanes affected by traffic control that will be open to traffic.
- C. Indicate signing with MUTCD designation, cone placement (including spacing), changeable message signs, flashing arrow boards, pavement markings, and other methods of delineation and reference to appropriate standards and sign designations.
- D. Dimension location of signs and cone tapers.
- E. Location of any and all flagmen, if applicable.
- F. Identify side streets and driveways affected by construction and show how they will be handled.
- G. Show how pedestrian and bicycle traffic will be handled through the construction site during all hours including edge grinding operation.
- H. Show locations of night time lighting if applicable.
- I. Modification to Traffic Signal operations in the vicinity of the project. Contractor shall be responsible for making arrangements with the City's Traffic Signal Technician at least 48 hours in advance before starting any work in or nearby a signalized intersection if any signal operations need to be modified.
- J. Separate Traffic Control Plans shall be prepared for each phase of a construction project and shall be submitted for City's review and approval.

No work except for installation of project identification signs will be allowed to commence prior to approval of the Traffic Control Plan.

Residents, businesses, delivery to businesses, and customer parking shall be notified in writing by the Contractor at least five (5) calendar days prior to any activity that will impact access to their property.

The City of Petaluma Traffic Control Design and Construction Standards (Series 700) shown elsewhere in these specifications are guidelines only. The CONTRACTOR is not relieved from his/her responsibility for submitting his/her own traffic control plan.

**The CONTRACTOR's failure to comply with the requirements of this section will be sufficient cause for the ENGINEER to suspend work at no cost to the City.**

All costs involved for completing all work described in this section shall be considered to be included in the contract price paid for Traffic Control System and no additional compensation shall be allowed therefore.

- 3-20. TRAFFIC CONTROL SYSTEM FOR LANE CLOSURE - A traffic control system shall consist of closing traffic lanes in accordance with the details shown on the plans, the City of Petaluma Traffic Control Design and Construction Standards Series 700, the provisions of Section 12, "Temporary Traffic Control", of the Standard Specifications, and the provisions under "Maintaining Traffic" elsewhere in these supplementary general conditions.

The provisions in this section will not relieve the CONTRACTOR from his/her responsibility to provide such additional devices or take such measures as may be necessary to comply with the provisions in Section 7-1.04, "Public Safety", of the Standard Specifications.

During the hours of darkness, as defined in Division 1, Section 280, of the Vehicle Code, portable signs shown on the plans to be illuminated shall be, at the option of the CONTRACTOR, either; illuminated signs in conformance with the provisions in Section 12-3.06B(3), "Portable Signs", of the Standard Specifications; or Reflexite vinyl microprism reflective sheeting signs; or 3M high intensity reflectorized sheeting on aluminum substrate signs or Seibulite Brand Ultralite Grade Series, encapsulated lens retroreflective sheeting signs; or equal.

Each vehicle used to place, maintain and remove components of a traffic control system on arterials and collectors shall be equipped with a Type II flashing arrow sign which shall be in operation when the vehicle is being used for placing, maintaining, or removing said components. The sign shall be controllable by the operator of the vehicle while the vehicle is in motion. The flashing arrow sign shown on the plans shall not be used on the vehicles which are doing the placing, maintaining and removing of components of a traffic control system, and shall be in place before a lane closure requiring its use is completed.

If any component in the traffic control system is displaced, or ceases to operate or function as specified, from any cause, during the progress of the work, the

CONTRACTOR shall immediately repair said component to its original condition or replace said component and shall restore the component to its original location.

When lane closures are made for work periods only, at the end of each work period, all components of the traffic control system, except portable delineators placed along open trenches or excavation adjacent to the traveled way shall be removed from the traveled way and shoulder. If the CONTRACTOR so elects, said components may be stored at selected central locations, approved by the ENGINEER, within the limits of the City right-of-way.

When traffic is shifted across the centerline, the CONTRACTOR shall provide W57 signs at 300-foot intervals and on both sides of intersections to direct traffic in proper lanes. Flashing arrow boards shall be required for any lane closures on any streets.

The adjustment provisions in Section 4-1.05, "Changes and Extra Work", of the Standard Specifications, shall not apply to the item of traffic control system. Adjustments in compensation for traffic control system will be made only for increased or decreased traffic control system required by changes ordered by the ENGINEER and will be made on the basis of the cost of the increased or decreased traffic control necessary. Such adjustment will be made on a force account basis as provided in Section 9-1.04, "Force Account", of the Standard Specifications for increased work, and estimated on the same basis in the case of decreased work.

Traffic control system required by work which is classed as extra work, as provided in Section 4-1.05 of the Standard Specifications, will be paid for as a part of said extra work.

The contract lump sum price paid for "Traffic Control System" shall include full compensation for furnishing all labor (including flagging costs), materials, signs, tools, equipment and incidentals, and for doing all the work involved in furnishing, placing, operating, maintaining, repairing, replacing, changing messages on changeable message signs as requested by the Engineer, moving and removing the components of the traffic control system as shown on the plans, as specified in the Standard Specifications and these Special Provisions, and as directed by the Engineer.

- 3-21. CONSTRUCTION AREA SIGNS – Project sign and construction area signs shall be furnished, installed, maintained, and removed when no longer required in accordance with the provisions in Section 12, "Construction Area Traffic Control Devices", of the Standard Specifications.

Construction area signs will be installed prior to start of construction and maintained in place for the duration of the project by the CONTRACTOR. Signs shall be repaired or replaced at no cost to the City of Petaluma, if damaged or stolen. The CONTRACTOR shall remove the signs and posts at the completion of the project and with prior approval of the ENGINEER.

All costs involved in purchasing and installing construction area and project signs shall be considered as included in the Lump Sum price paid for Traffic Control System.

- 3-22. NOTICE OF POTENTIAL CLAIM - If for any reason the CONTRACTOR deems that additional compensation is due him/her for work or materials not clearly provided for in the contract, plans, or specifications or previously authorized extra work, a Notice of Potential Claim shall be made. The CONTRACTOR shall give the ENGINEER a written Notice of Potential Claim for such additional compensation before work begins on the items on which the claim is based. The notice shall set forth the reasons for which the CONTRACTOR believes additional compensation will or may be due and the nature of the costs involved. The CONTRACTOR shall afford the ENGINEER every opportunity and facility for keeping records of the actual cost of the work. The CONTRACTOR shall keep records of the disputed work in accordance with Contract General Conditions, Section 11.3, "Cost of Work (Based on Time and Materials)."

If such notification is not given or the ENGINEER is not afforded proper opportunity by the CONTRACTOR for keeping strict account of actual cost as required, then the CONTRACTOR hereby agrees to waive any claim for such additional compensation. Such notice by the CONTRACTOR and the fact that the ENGINEER has kept account of the cost of the work shall not in any way be construed as proving or substantiating the validity of the claim. When the work on which the claim for additional compensation is based has been completed, the CONTRACTOR shall, within 10 calendar days, submit his/her written claim to the ENGINEER who will present it to the City for consideration in accordance with local laws or ordinances. The CONTRACTOR is directed to Section 17.20 "Resolution of Construction Claims" of the General Conditions.

Any claim for overhead type expenses or costs, in addition to being certified as stated above, shall be supported by an audit report of an independent Certified Public Accountant. Any claim for overhead shall also be subject to audit by the City at its discretion.

Any costs or expenses incurred by the City in reviewing or auditing any claims that are not supported by the CONTRACTOR's cost accounting or other records shall be deemed to be damages incurred by the City within the meaning of the California False Claims Act.

Nothing in this subsection shall be construed as a waiver of the CONTRACTOR's right to dispute final payment based on differences in in-place quantity measurements or computations of unit priced pay items.

- 3-23. ACCESS TO DRIVEWAYS – All accesses for local businesses and residents shall be maintained at all times unless approved by the ENGINEER. Temporary ramps will be required each night for access to driveways for residences and commercial access. The Contractor shall coordinate with each driveway user as needed.



- 3-24. EXISTING WATER VALVES, MONUMENTS AND MANHOLES – The City shall have access at all times to water valves, monuments, and manholes except immediately following a construction operation as noted below.

Prior to placement of paving, all manholes, monuments, and valves covered by paving, shall be clearly marked in white paint before the close of that work day. Throughout the construction process, the CITY shall have access to manholes, monuments, and valves within 48 hours of any operation affecting the manholes, monuments and valves.

**A penalty of Fifty Dollars (\$50) per each valve, monument, and manhole that is not raised, or that the CITY is not provided easy access to, will be assessed against the contractor for each calendar day.**

- 3-25. CITY STANDARD DRAWINGS – The CONTRACTOR shall conform to the City of Petaluma Design and Construction Standards and Specifications for the work to be done in this contract.

Attention is directed to Standard Detail 203, “Curb, Gutter, Sidewalk, Driveway X-Section” as the City of Petaluma no longer requires a 6 x 6 x 10 gauge welded wire mesh over the reinforcing bars. Use Reinforcement bars only.

**SECTION IV**  
**TECHNICAL SPECIFICATIONS**

**TABLE OF CONTENTS**

<i>SECTION</i>	<i>DESCRIPTION</i>	<i>Page No.</i>
20	DUST CONTROL	1
30	MOBILIZATION/DEMOBILIZATION	2
50	TRAFFIC CONTROL	3
80	EARTHWORK	6
180	FINAL CLEANUP	9
190	PRESERVATION OF PROPERTY	10
220	AGGREGATE BASE	11
400	MINOR CONCRETE AND GROUT	13

## **SECTION 20 DUST CONTROL**

### 20A. GENERAL

Dust control shall conform to the provisions in Section 14, "Dust Control," of the 2010 Standard Specifications and these technical specifications.

### 20B. SUBMITTALS

N/A

### 20C. MATERIALS

N/A

### 20D. CONSTRUCTION

The following on-site mitigation measures shall be implemented for the duration of this project:

- All dust-producing work and unpaved construction sites shall require at a minimum watering in the late morning and at the end of the workday; the frequency of watering shall be increased if dust is mobilized by wind or traffic.
- Contractor shall maintain dust control to the satisfaction of the City Engineer, seven (7) days a week, 24 hours per day.
- The Engineer at his discretion may require sprinkling at any time or place.
- At the end of each work week, the Contractor shall sweep all streets in the work zone with a commercial grade street sweeping machine.

Water is available from the CITY at \$3.84 per one hundred (100) cubic feet provided that the CONTRACTOR meters the water so used with a CITY furnished meter (a deposit will be required) and a CONTRACTOR furnished valve assembly. Cost may be adjusted at the time of construction.

### 20E. QUALITY CONTROL

N/A

### 20F. MEASUREMENT AND PAYMENT

Full compensation for conforming to the provisions in this section, not otherwise provided for, shall be considered as included in prices paid for the various contract items of work involved and no additional compensation will be allowed therefor.

**END OF SECTION**

**SECTION 30**  
**MOBILIZATION/DEMobilIZATION**

30A. GENERAL

Mobilization shall consist of obtaining all required insurance, bonds, and permits; preparatory work and operations necessary for the movement of personnel, equipment, supplies, and incidentals to the project site; preparation of a construction schedule; badging and training of flaggers, and other employees; and all other work which must be performed or cost incurred prior to beginning work on the various contract items at the project site.

CONTRACTOR is solely responsible for location a proper staging area that will allow the work to be performed successfully.

30B. SUBMITTALS

N/A

30C. MATERIALS

N/A

30D. CONSTRUCTION

N/A

30E. QUALITY CONTROL

N/A

30F. MEASUREMENT AND PAYMENT

Full compensation for conforming to the provisions in this section, not otherwise provided for, shall be considered as included in prices paid for the various contract items of work involved and no additional compensation will be allowed therefor.

**END OF SECTION**

## SECTION 50 TRAFFIC CONTROL

### 50A. GENERAL

Construction area traffic control devices shall be installed and maintained in accordance with the applicable sections of these Technical Specifications, the Standard Specifications, the current edition of the Manual On Uniform Traffic Control Devices (MUTCD), and applicable California supplements to the MUTCD, and as directed by the Engineer.

### 50B. SUBMITTALS

#### 50B.1 TRAFFIC CONTROL PLAN

The CONTRACTOR shall submit to the ENGINEER for approval at least 48 hours prior to start of work a copy of the traffic control plan minimum 11-inch x 17-inch drawing, which shall represent actual conditions as stated in Section 3-19, "Maintaining Traffic" of the Special Provisions. Traffic Control Plans submittals will be reviewed by City of Petaluma, County of Sonoma and Caltrans. No lane closures will be allowed without a written approval from the agencies and/or the ENGINEER.

The CONTRACTOR'S failure to comply with the requirements of this section will be sufficient cause for the ENGINEER to suspend work at no costs to the CITY.

If any component in the traffic control system is displaced, or ceases to operate or function as specified, from any cause, during the progress of the work, the CONTRACTOR shall immediately repair said component to its original condition or replace said component and shall restore the component to its original location.

When lane closures are made for work periods only, at the end of each work period, all components of the traffic control system, except portable delineators placed along open trenches or excavation adjacent to the traveled way shall be removed from the traveled way and shoulder. If the CONTRACTOR so elects, said components may be stored at selected central locations, approved by the ENGINEER, within the limits of the highway right-of-way.

Where pavement markers, traffic stripes and/or pavement markings are obliterated by any construction work activity, they shall be replaced by the CONTRACTOR. The entire pavement markings shall be replaced regardless how much area is obliterated by the construction and shall be determined by the ENGINEER. Traffic stripes and pavement markings shall be minimum 0.15 inch thick thermoplastic conforming to Caltrans Standard Specifications Section 84.

## 50C. MATERIALS

### 50C.1 CONSTRUCTION AREA SIGNS

Construction area signs shall be furnished, installed, maintained, and removed when no longer required in accordance with the provisions in Section 12, "Construction Area Traffic Control Devices", of the Standard Specifications.

Construction area signs will be installed prior to start of construction and maintained in place for the duration of the project by the CONTRACTOR. If damaged or stolen, signs shall be repaired or replaced at no cost to the City of Petaluma. With prior approval of the ENGINEER, the CONTRACTOR shall remove the signs and posts at the completion of the project.

## 50D. CONSTRUCTION

### 50D.1 HOURS

All work shall be performed between the hours of 7:00 a.m. and 5:00 p.m. unless approved in writing by the Engineer. Lane closures, if required, will be requested by the CONTRACTOR to the respective local and state agency. The CONTRACTOR shall maintain vehicle access to businesses, homes, and other properties at all times while work is in progress.

No work and/or preparation of work shall be performed between 7:00 p.m. and 7:00 a.m. except work required under said Sections 7-1.03 and 7-1.04 of the Standard Specifications or as approved in writing by the Engineer.

### 50D.2 PEDESTRIAN / BICYCLE TRAFFIC CONTROL

The CONTRACTOR is directed to Chapter 6D and Part 9, Pedestrian and Worker Safety and Traffic Control of Bicycle Facilities, in the MUTCD and applicable California supplements, the improvement plans and these Technical Specifications.

Pedestrians shall be provided with a safe, convenient, and accessible path that at a minimum replicates the most desirable characteristics of the existing sidewalk, path, or footpath.

Bicycle traffic shall be detoured around the construction zones.

The CONTRACTOR shall construct and maintain temporary pedestrian pathways through the work zone that shall be in compliance with the requirements of the Americans with Disabilities Act (ADA), the MUTCD, and applicable California supplements.

Pedestrian routes shall not be impacted for the purposes of any non-construction activities such as parking of vehicles or equipment, or stock piling of materials. Pedestrians shall not be led into conflicts with work site vehicles, equipment or operations.

50E. QUALITY CONTROL

N/A

50F. MEASUREMENT AND PAYMENT

Full compensation for conforming to the provisions in this section, not otherwise provided for, shall be considered as included in prices paid for the various contract items of work involved and no additional compensation will be allowed therefor.

The cost of furnishing all flaggers, including transporting flaggers, to provide for passage of public traffic through the work under the provisions in Section 7-1.03, "Public Convenience", and Section 7-1.04, "Public Safety" of Standard Specifications 2010, shall be considered as included in the contract lump sum price paid for traffic control and no additional allowance will be made therefor.

**END OF SECTION**



## **SECTION 80 EARTHWORK**

### **80A. GENERAL**

The CONTRACTOR shall furnish all labor, materials, equipment, and incidentals necessary to perform all earthwork required for construction. Such earthwork shall include, but not be limited to the loosening, removing, loading, transporting, depositing, and compacting in its final location of all materials wet and dry, as required for the purposes of completing the Work specified in the Contract Documents. The Work shall also include, but not be limited to, clearing and grubbing the project area outside of the roadway in preparation for the construction furnishing, phasing, and removing of shoring, dewatering, supporting of structures and utilities above and below the ground; all backfilling around structures and utilities and all backfilling of trenches and pits; the disposal of excess excavated materials; borrowing materials for fills; and all other incidental earthwork; all in accordance with the requirements of the Contract Documents.

Earthwork/Roadway excavation shall conform to the applicable provisions of Section 19 of the Standard Specifications. Roadway excavation shall consist of excavation of the roadway prism within the limits for the subjected streets reconstruction and the roadway excavation and embankment construction, for the utility improvements, as shown on the plans, and disposal of excess material, as specified herein.

### **80B. SUBMITTALS**

N/A

### **80C. MATERIALS**

All materials to be used i.e Class 2 Aggregate Base, Aggregate Base, Coarse Bedding material, Geotextile Fabric, Drain Rock etc. shall comply with the quality requirements of Standard Specifications Section 19 and other applicable specifications.

Controlled density fill shall be manufactured by, or approved equal: Shamrock Materials, Inc., Mix Design Number 1500.

Controlled density fill shall be hatched by a ready mixed concrete plant and mixed and delivered to the jobsite by means of transit mixing trucks.

No equipment or traffic shall be allowed on the controlled density fill until the surface of the controlled density fill will withstand the weight of equipment or traffic without displacement or damage. If necessary to prevent displacement or damage, provide steel trench plates that span the trench or other means that prevent equipment or traffic contact with controlled density fill.

## 80D. CONSTRUCTION

The CONTRACTOR shall submit an excavation plan for review before any excavation commences. Excavations in areas of pedestrian or vehicular traffic shall be open the minimum time necessary.

### 80D.1 GENERAL

Except when specifically provided to the contrary, excavation shall include the removal of all materials of whatever nature encountered, including all obstructions of any nature that would interfere with the proper execution and completion of the Work. The removal of said materials shall conform to the lines and grades shown or ordered. Unless otherwise provided, the entire construction site shall be stripped of all vegetation and debris, and such material shall be removed from the site prior to performing any excavation or placing any fill.

Excavations shall be sloped or otherwise supported in a safe manner in accordance with applicable State safety requirements and the requirements of OSHA Safety and Health Standards for Construction (29CFR1926). All excavations shall be dewatered in accordance with Section 23, "Dewatering", and shored in accordance with Section 14.

### 80D.2 ROADWAY EXCAVATION

Following clearing, stripping and required excavations, the exposed subgrade soil should be scarified to a depth of 8 inches; moisture conditioned to within 3% above optimum moisture content and compacted to at 90% relative compaction as evaluated by ASTM D1557 to produce a firm and unyielding surface when proof-rolled with heavy construction equipment. Subgrades should be maintained at a moist condition until fill placement to prevent shrinkage cracks due to drying.

### 80D.3 TREE REMOVAL

During excavation if tree roots greater than two (2") inches are encountered the contractor must notify the engineer and arborist prior to cutting or removal of roots. In cases where roots are too large and where the sidewalk/driveway cannot be constructed to City Standards due to existing trees and roots, contractor shall remove the tree, after receiving approval from the arborist. Contractor is responsible for coordination with PG&E, AT&T, and other utility companies for tree removal in the case that overhead lines are present. Contractor must be properly licensed to remove the tree. If Contractor is not properly licensed, they are responsible for finding a subcontractor with either a C27 or a C61/D49 License.

Arborist will make an assessment and provide instructions on whether or not Contractor will be responsible to replant a new tree.

## 80E. QUALITY ASSURANCE

All materials to be used shall be natural materials. The requirements to use recycled materials shall only be approved by the ENGINEER.

80F. MEASUREMENT AND PAYMENT

**Earthwork** will be included in various items of work and shall be full compensation for conforming to the provisions in this section, all sawcutting, excavation, pavement demolition, concrete demolition, hauling and proper disposal to offsite facilities, furnishing all labor, materials, tools, and equipment, and doing all work involved, including any other items necessary for performing this work not specifically enumerated in the plans and specifications, and no additional allowance will be made therefor.

**END OF SECTION**

**SECTION 180  
FINAL CLEANUP**

180A. GENERAL

Before final inspection of the work, the Contractor shall clean the work and all ground occupied by him in connection with the work, of all rubbish, excess materials (including liquid asphalt), and equipment. The sidewalks and curbs shall be thoroughly swept clean of all dirt, dust and foreign material. All parts of the work shall be left in neat and presentable condition.

180B. SUBMITTALS

N/A

180C. MATERIALS

N/A

180D. CONSTRUCTION

N/A

180E. QUALITY CONTROL

N/A

180F. MEASUREMENT AND PAYMENT

Payment for cleaning of sidewalks and curbs, and clean up in general, shall be considered as included in the unit bid price for other contract items and no additional payment shall be made therefor.

**END OF SECTION**

**SECTION 190  
PRESERVATION OF PROPERTY**

190A. GENERAL

Attention is directed to the provisions in Section 5-1.36, "Property and Facility Preservation," of the Standard Specifications and these Special Provisions.

190B. SUBMITTALS

N/A

190C. MATERIALS

N/A

190D. CONSTRUCTION

Existing trees, shrubs, and other plants, that are not to be removed and are injured or damaged by reason of the Contractor's operations, shall be replaced by the Contractor in accordance with the requirements in Section 20-2.03B, "Replacement," of the Standard Specifications and in accordance with the requirements contained herein.

Roadside mailboxes shall be protected from injury or damage during construction.

190E. QUALITY CONTROL

N/A

190F. MEASUREMENT AND PAYMENT

Full compensation for conforming to the provisions in this section, not otherwise provided for, shall be considered as included in prices paid for the various contract items of work involved and no additional compensation will be allowed therefor.

**END OF SECTION**

## **SECTION 220 AGGREGATE BASE**

### **220A. GENERAL**

Aggregate base shall conform to Section 26, “Aggregate Bases,” of the Caltrans Standard Specifications, the City of Petaluma's Design and Construction Standards and Specifications, the plans, and these Technical Specifications.

### **220B. SUBMITTALS**

Contractor shall submit to the City the typical gradation document of the specified aggregate base in the plans and/or these technical specifications.

### **220C. MATERIALS**

Backfill material shall be Class 2 aggregate base three-quarter (3/4) inch maximum conforming to Section 26 of the Standard Specifications.

Controlled Density Fill (CDF) shall be mix design No. 1500 manufactured by Shamrock Materials Inc. or approved equal.

### **220D. CONSTRUCTION**

#### **220D.1 EARTHWORK**

Grading shall comply with the requirements of Section 19, “Earthwork”, of the Standard Specifications. During any grading operations, the Contractor is specifically directed to Subsection 19-1.02, “Preservation of Property”. The Contractor shall protect any items, facilities, or improvements, as necessary, in order to avoid causing damage.

#### **220D.2 SUBGRADE**

The existing subgrade material below the new aggregate base shall be moisture conditioned to optimum moisture content, and compacted to a minimum of 95 percent relative compaction.

#### **220D.3 AGGREGATE BASE**

The constructed thickness of the aggregate base layer shall not be less than the design thickness minus 0.04' (1/2 inch). Aggregate base shall be Class 2, 3/4 inch maximum, and shall be firm and unyielding. The minimum sand equivalent shall be 31 for any individual test. The requirements to use recycled Class II Aggregate base shall only be approved by the ENGINEER.

220E. QUALITY CONTROL

Aggregate must comply with the grading requirements as shown in Section 26 of the Standard Specifications.

220F. MEASUREMENT AND PAYMENT

Full compensation for Aggregate Base shall be considered as included in prices paid for the various contract items of work involved and no additional compensation will be allowed therefor.

**END OF SECTION**

**SECTION 400  
MINOR CONCRETE**

400A. GENERAL

New concrete facilities including curbs, curbs and gutters, sidewalks; ADA curb ramps, sidewalk drainage, and commercial and private driveways shall be constructed at the locations indicated by City issued Work Orders or as directed by the Engineer. Finished product shall be in accordance with the most current Standard Specifications and City of Petaluma Standard Details.

All work performed shall be measured and paid for based on the contract unit prices listed in Bid schedule or as listed in Section 400.

400B. SUBMITTALS

A copy of this specification section, with any addendum updates included, and all referenced and applicable sections, with any addendum updates included, shall be submitted with each paragraph check-marked to indicate specification compliance or marked to indicate requested deviations from specification requirements.

If deviations from the specifications are indicated, and therefore requested by the CONTRACTOR, each deviation shall be underlined and denoted by a number in the margin to the right of the identified paragraph. The remaining portions of the paragraph not underlined will signify compliance on the part of the CONTRACTOR with the specifications. The submittal shall be accompanied by a detailed, written justification for each deviation. Failure to include a copy of the marked-up specification sections, along with justification(s) for any requested deviations to the specification requirements, with the submittal shall be sufficient cause for rejection of the entire submittal with no further consideration.

Submittals shall be provided to confirm that material to be used comply with information specified herein.

Mix Designs: Prior to beginning the Work, the CONTRACTOR shall submit to the ENGINEER, for review, preliminary concrete mix designs which shall show the proportions and graduations of all materials proposed for each class and type of concrete specified. The mix designs shall be designed by an independent testing laboratory acceptable to the ENGINEER. All costs related to such mix design shall be borne by the CONTRACTOR. This Specification sets the minimum requirements for mix design that meets all requirements specified herein.

400C. MATERIALS

400C.1 GENERAL



Concrete used for curb, gutters, sidewalks, and ADA curb ramps shall meet the following requirements:

Compressive Strength: Minimum 3000 psi @ 28 days (6-sack min.)  
Polypropylene Fiber Reinforcement: 1.5 lbs/cy  
(0.01% by volume), ¾ inch or 1-½ inch length

Maximum Slump: 4 inches

Steel Reinforcement: 60 ksi

All concrete shall have an air entrainment of  $4.0 \pm 1.0$  percent.

The Contractor shall be responsible for all costs associated with the required mix design.

Where new concrete is placed adjoining existing concrete, steel dowels (No. 4 x 20 inch) shall be installed at 24 inches o.c. into existing concrete with a six-inch embedment. The dowels shall be epoxy grouted.

#### 400C.2 FORMS

Concrete forms shall be metal, wood, plywood, or other approved material that will not adversely affect the concrete and will facilitate placement of concrete to the shape, form, line, and grade indicated. Metal forms shall be an approved type that will accomplish such results.

Plywood for concrete formwork shall be new, waterproof, synthetic resin bonded, exterior type Douglas Fir or Southern Pine plywood manufactured especially for concrete formwork.

Lumber shall be Douglas Fir or Southern Pine, construction grade or better.

#### 400C.3 REINFORCEMENT STEEL

Reinforcement steel shall be deformed bars conforming to ASTM A615 Grade 60 or ASTM A706. Welded wire fabric shall conform to latest edition of CRSI Manual of Standard Practice.

#### 400C.4 CONCRETE

Cement: Portland cement Type II conforming to ASTM C150.

Water: Clean and free from oil, acid, alkali, organic matter, or other deleterious substances and shall contain no more than 50 ppm chlorides as Cl no more than 50 ppm sulfates as  $SO_4^{-2}$ .

Aggregates:

Natural aggregates shall be free from deleterious coatings, conforming to ASTM C33, together with all referenced ASTM Standard Specifications, except as modified herein. Aggregates shall not be potentially reactive as defined in Appendix XI of ASTM C33. Aggregates shall be thoroughly and uniformly washed before use.

Fine aggregates shall conform to ASTM C33. Materials finer than the 200 sieve shall not exceed 4 percent. Use only clean, sharp, natural sand.

Coarse aggregate shall be: 1) natural gravels, 2) a combination of gravels and crushed gravels, 3) crushed stone, or 4) a combination of these materials containing no more than 15 percent flat or elongated particles (long dimension more than five times the short dimension). Materials finer than the 200 sieve shall not exceed 0.5 percent.

Ready-Mixed Concrete: Ready-mixed concrete shall conform to the requirements of ASTM C94.

400C.5 CURING COMPOUND

Liquid membrane-forming curing compound shall be clear or translucent, suitable for spray application and shall conform to ASTM C309, Type 1.

400C.6 EXPANSION JOINT FILLER

Expansion joint filler shall be ½-inch thick, preferred asphalt-impregnated, expansion joint material, conforming to ASTM D994.

400C.7 GROUTS

Epoxy Grout. Epoxy grout for bonding reinforcing bars to existing concrete structures shall be manufactured by, or approved equal:

- A. Adhesive Engineering, Concessive No. 1001
- B. Sika Chemical Corp., Sikastix 350, 370, or 390, as applicable

Ordinary Type Grout (Dry Pack). One part portland cement to 2 parts fine sand. Add sufficient water to form a damp formable consistency.

Non-Shrink Grout. Non-shrink grout shall be nonmetallic, nongas-liberating type, as manufactured by, or approved equal:

- A. Master Builders, Master Flow 713

B. UPCO Company, UPCON, High Flow

Cement Grout. Cement grout shall be composed of one part cement, two parts sand, and the minimum amount of water necessary to obtain the desired consistency. Where needed to match the color of adjacent concrete, white Portland cement shall be blended with regular cement as needed. The minimum compressive strength at 28 days shall be 4000 psi.

400C.8 BONDING AGENT

Bonding agent shall be manufactured by, or approved equal:

- A. W. R. Grace and Company, Cambridge, MA
- B. Sika Chemical Corp., Lyndhurst, NJ
- C. Adhesive Engineering Company, San Carlos, CA

Product shall be recommended by manufacturer as suitable to meet job requirements with regard to surface, pot life, set time, vertical or horizontal application, forming restrictions, etc. Furnish manufacturer's specific instructions for this job application, and obtain ENGINEER's approval prior to application.

400D. CONSTRUCTION

400D.1 GENERAL

Concrete curbs, gutters, and ADA curb ramps shall conform with Section 73 of the Caltrans Standard Specifications, Caltrans Standard Plans A88A and A88B and shall be as shown on Standard Plans 202, 203, 204, 205, 206, and 207 of the City of Petaluma Street Standard Details 200 Series. All curb ramps and curbs & gutters shall have No. 4 reinforcing steel re-bars at 12" o.c. each way. Concrete curbs shall have two No. 4 horizontal steel re-bars.

All work shall conform to the provisions of Section 90 of the Standard Specifications. All ADA curb ramps shall comply with Title 24 and current Caltrans and UBC requirements.

400D.2 EARTHWORK

Excavation, backfill and compaction shall be in accordance with Section 19, "Earthwork" of the Standard Specifications.

400D.3 FORMS

Construct all form work in accordance with ACI 347. Before placing the concrete, the contact surfaces of forms shall be coated with a suitable non-staining form

coating compound or shall be given two coats of nitrocellulose lacquer. All excess coating shall be removed by wiping with cloths.

#### 400D.4 REINFORCEMENT

All reinforcement shall be provided as indicated together with all necessary ties, spacers, supports, and other devices necessary to install and secure the reinforcement properly. All reinforcement, when placed, shall be free from loose rust, scale, oil, grease, and other coatings and foreign substances that would reduce or destroy the bond.

#### 400D.5 MIXING

Concrete mixing shall conform to ACI 304, current edition, and to the other requirements specified herein.

Concrete shall be discharged at the job within 1-½ hours after the water has been added to the cement and aggregates mixture. Concrete may be machine mixed at the job site or ready mixed at the CONTRACTOR's option, and shall conform to the following requirements:

1. Site Mixing: Concrete produced at the site shall be mixed in a batch mixer with a capacity of not less than ½ cubic yard. The minimum mixing time for each batch (from the time when all solid materials and water are in the drum) shall be 1-½ minutes for mixers of 1 cubic yard capacity or less; for mixers of larger capacity, the mixing time shall be increased 30 seconds for each additional ½ cubic yard or fraction thereof. The mixer shall revolve at a uniform peripheral speed of about 200 rpm. The entire batch shall be discharged before the mixer is recharged.
2. Ready Mixed Concrete: All concrete constituents for ready mixed concrete shall be batched at the central plant. All central plant and rolling stock equipment and methods shall conform to the requirements of ASTM C94, as applicable.

#### 400D.6 PLACING

No concrete shall be placed after there is evidence of initial set. Concrete placement will not be permitted when weather conditions prevent proper placement and consolidation. Consolidation of concrete shall be with internal concrete vibrators supplemented by hand spading, rodding, and tamping. Vibrating equipment shall be adequate to thoroughly compact the concrete. Concrete shall be compacted, screeded to grade, and prepared for the specified finish.

#### 400D.7 CURING

Concrete shall be cured by protecting it against loss of moisture, rapid temperature change, and mechanical injury for at least three days after placement. Clear liquid membrane compound shall be used. After finishing operations have been completed, the entire surface of the newly placed concrete shall be covered by the curing medium. The edges of the concrete exposed by the removal of forms shall be protected immediately to provide these surfaces with continuous curing treatment.

The concrete shall be allowed to cure for seventy-two hours prior to placing adjacent asphalt concrete.

#### 400E. QUALITY CONTROL

Without limiting the generality of other requirements of these Specifications, all work specified herein shall conform to or exceed the requirements of the Building Code and the applicable requirements of the following documents to the extent that the provisions of such documents are not in conflict with the requirements of this Section; provided, that for Building Codes, the latest edition of the code, as adopted as of the date of award by the agency having jurisdiction, shall apply to the Work.

ACI 304R Guide for Measuring, Mixing, Transporting and Placing Concrete

ACI 347R Guide to Formwork for Concrete

ASTM A 185 Steel Welded Wire, Fabric, Plain, for Concrete Reinforcement

ASTM A615 Deformed and Plain Billet-Steel Bars for Concrete Reinforcement

ASTM C33 Concrete Aggregates

##### 400E.1 FIELD SAMPLING AND TESTS

The CONTRACTOR shall be responsible for the quality of the materials and workmanship of the placement of the concrete. Sampling, preparation of test specimens, and testing will be the ENGINEER's responsibility.

##### 400E.2 SLUMP

Concrete consistency shall be determined by slump tests in accordance with ASTM C143. At least one test shall be made at the commencement of the concrete placement and at the time standard test cylinders are molded.

Tests will be performed by the ENGINEER.

#### 400F. MEASUREMENT AND PAYMENT

**Remove and Replace Concrete Sidewalk** shall be paid for at the contract unit price per square foot (SF), which shall include full compensation for removing and placing PCC sidewalk complete, in place, and shall include, but not limited to, demolition, saw cutting, root removal, excavation for placement of aggregate base, subgrade preparation; furnish and place 4” thick aggregate base; reinforcing bars; furnish and place concrete; weakened plane, construction joints and scoring, protection from vandalism, removal and disposal of existing sidewalks and material, and all other work required to complete work in place.

**Install New Concrete Sidewalk** shall be paid for at the contract unit price per square foot (SF), which shall include full compensation for placing PCC sidewalk complete, in place, and shall include, but not limited to, demolition, saw cutting, root removal, excavation for placement of aggregate base, subgrade preparation; furnish and place 4” thick aggregate base; reinforcing bars; furnish and place concrete; weakened plane, construction joints and scoring, protection from vandalism, removal and disposal of existing material, and all other work required to complete work in place.

**Remove and Replace Curb and Gutter** shall be paid for at the contract unit price per linear foot (LF), which price shall include full compensation for mobilization, site preparation and site clean-up, installation of concrete curb and gutter, removal and disposal of existing curb and gutter, excavation and grading, root pruning, backfilling, compaction, addition of lamp black paint, two (2) foot wide asphalt concrete conform, pedestrian and traffic control, and restoration of any damages including furnishing all labor, materials, tools, equipment and incidentals necessary to do all the work involved thereof and as directed by the Engineer, complete, in place, and accepted, and no additional compensation will be allowed therefor.

**Driveway – Residential and Driveway – Commercial** shall be paid for at the contract unit price per square foot (SF), which price shall include full compensation for mobilization, site preparation and site clean-up, installation of concrete driveway, removal and disposal of existing driveway, excavation and grading, root pruning, backfilling, compaction, addition of lamp black paint, two (2) foot wide asphalt concrete conform, pedestrian and traffic control, and restoration of any damages including furnishing all labor, materials, tools, equipment and incidentals necessary to do all the work involved thereof and as directed by the Engineer, complete, in place, and accepted, and no additional compensation will be allowed therefor.

**Existing driveways may vary in thickness and no additional compensation will be made for demolition and removal of existing concrete. New driveway shall be installed per these specification and City standard plans.**

Payment for **Curb Ramp – Case A or C** shall be paid for at the contract unit price each (EA), which shall include full compensation for mobilization, site preparation and site clean-up, installation of either a case A or C concrete curb ramp, removal and disposal of existing concrete within the ramp location and entire curb return, excavation for placement of aggregate base, subgrade preparation, furnish and place 4” thick aggregate

base, reinforcing steel, furnish and place concrete, furnish and place truncated dome panels, cast in place truncated domes, weakened plane, placing landscape soils and cobbles, relocation and adjustment of utility boxes, installation of storm drainage, deepened curbs, removal and transport of curb and gutter cobbles, construction joints and scoring, protection from vandalism and all other work required to complete the work in place. The limit of work included for each curb ramp shall include curb and gutter in front of the ramp on the entire curb return, the integral/retaining curb at ramps (where needed), the landing behind the ramp to the back of sidewalk (to the grade break), backfill of landscape planning mix, retaining curbs on the back of ramp and sidewalk, and all of the concrete to be replaced that is damaged or removed during the curb ramp installation. In addition, curb ramp limits shall also extend to the closest extension score marks or expansion joints at the grade break beyond the landing.

Payment for **Concrete Grinding – Sidewalk Vertical Displacement** shall be paid for at the contract unit price per linear foot (LF), which price shall include full compensation for conforming to the provisions in this section, furnishing all labor, materials, tools, equipment, for all grouting, minor concrete and grinding work, and incidentals, not specifically enumerated on the plans or these Specifications and no additional allowance will be made therefor.

Payment for **Cast-in-place Truncated Dome Panels (3'x5')** shall be paid for at the contract unit price per each (EA), which price shall include full compensation for site preparation and site clean-up, installation of truncated dome panels, including furnishing all labor, materials, tools, equipment and incidentals necessary to do all the work involved thereof and as directed by the Engineer, complete, in place, and accepted, and no additional compensation will be allowed therefor.

**END OF SECTION**

**SECTION V**

**CONSTRUCTION AGREEMENT**



## CONSTRUCTION AGREEMENT

FY \_\_\_\_\_ Fund \_\_\_\_\_ Cost Center \_\_\_\_\_ Object Code \_\_\_\_\_ Project # \_\_\_\_\_ Amount \$ \_\_\_\_\_

For multi-year contracts or contracts with multiple accounts:

FY \_\_\_\_\_ Fund \_\_\_\_\_ Cost Center \_\_\_\_\_ Object Code \_\_\_\_\_ Project # \_\_\_\_\_ Amount \$ \_\_\_\_\_

FY \_\_\_\_\_ Fund \_\_\_\_\_ Cost Center \_\_\_\_\_ Object Code \_\_\_\_\_ Project # \_\_\_\_\_ Amount \$ \_\_\_\_\_

FY \_\_\_\_\_ Fund \_\_\_\_\_ Cost Center \_\_\_\_\_ Object Code \_\_\_\_\_ Project # \_\_\_\_\_ Amount \$ \_\_\_\_\_

THIS AGREEMENT is dated as of the \_\_\_\_\_ day of \_\_\_\_\_ in the year 20\_\_\_\_, by  
(city use only)

and between CITY OF PETALUMA (hereinafter called "CITY") and  
(hereinafter called "CONTRACTOR").

CITY and CONTRACTOR, in consideration of the mutual covenants hereinafter set forth, agree as follows:

### ARTICLE 1. WORK

CONTRACTOR shall complete the WORK as specified or indicated in the CITY'S Contract Documents entitled Operations Concrete Contract.

### ARTICLE 2. COMPLETION OF WORK

The WORK shall be completed to the satisfaction of CITY within 45 (Forty Five) working days from the commencement date stated in the Notice to Proceed. In no event, however, shall the WORK to be performed under this contract be considered to be complete until all construction items called for on the drawings, and specifications have been completed and the contract price paid in full.

### ARTICLE 3. LIQUIDATED DAMAGES

A. CITY and the CONTRACTOR recognize that time is of the essence of this Agreement and that the CITY will suffer financial loss if the WORK is not completed within the time specified in Article 2 herein, plus any extensions thereof allowed in accordance with Article 12 of the General Conditions. It is hereby understood and agreed that it is and will be difficult and/or impossible to ascertain and determine the actual damage which the CITY will sustain in the event of and by reason of the CONTRACTOR's failure to fully perform the WORK or to fully perform all of its contract obligations that have accrued by the time for completion as specified in Article 2 herein and/or as specified for completion of any scheduled operations or works described in the Special Provisions. It is, therefore, agreed in accordance with California Government Code Section 53069.85 that the CONTRACTOR will forfeit and pay to the CITY liquidated damages in the sum of \_\_\_\_\_ Dollars (\$\_\_\_\_\_) per day for each and every calendar day that expires after the time for completion specified in Article 2 herein and/or as specified for completion of any scheduled operations or works described in the Special Provisions except as

otherwise provided by extension of time pursuant to Article 12 of the General Conditions. It is further understood and agreed in accordance with California Government Code Section 53069.85 that the liquidated damages sum specified in this provision is not manifestly unreasonable under the circumstances existing at the time this contract was made, and that the CITY may deduct liquidated damages sums in accordance with this provision from any payments due or that may become due the CONTRACTOR.

- B. Liquidated damages will continue to accrue at the stated rate until final completion of the WORK. Accrued liquidated damages may be deducted by the CITY from amounts due or that become due to the CONTRACTOR for performance of the WORK. Liquidated damages may not be waived or reduced by CITY unless expressly waived or reduced in writing by the ENGINEER.

#### ARTICLE 4. PREVAILING WAGES

- A. Pursuant to California Labor Code Section 1771, CONTRACTOR and any subcontractor shall pay all workers employed in execution of the WORK in accordance with the general rate of per diem wages specified for each craft, classification, or type of worker needed to execute the WORK. Copies of the prevailing rates of per diem wages are on file at the City Clerk's office and shall be made available to any interested party on request.
- B. CONTRACTOR is required to pay all applicable penalties and back wages in the event of violation of prevailing wage law, and CONTRACTOR and any subcontractor shall fully comply with California Labor Code Section 1775, which is incorporated by this reference as though fully set forth herein.
- C. CONTRACTOR and any subcontractor shall maintain and make available for inspection payroll records as required by California Labor Code Section 1776, which is incorporated by this reference as though fully set forth herein. CONTRACTOR is responsible for ensuring compliance with this section. CONTRACTOR and any subcontractor shall maintain and make available for inspection payroll records as required by California Labor Code Section 1776, which is incorporated by this reference as though fully set forth herein. CONTRACTOR is responsible for ensuring compliance with this section. In addition, CONTRACTOR and any subcontractor shall submit certified payroll records to the Labor Commissioner online: <http://www.dir.ca.gov/Public-Works/Certified-Payroll-Reporting.html>.
- D. CONTRACTOR and any subcontractor shall fully comply with California Labor Code Section 1777.5, concerning apprentices, which is incorporated by this reference as though fully set forth herein. CONTRACTOR is responsible for ensuring compliance with this section.
- E. In accordance with California Labor Code Section 1810, eight (8) hours of labor in performance of the WORK shall constitute a legal day's work under this Agreement. CONTRACTOR and any subcontractor shall pay workers overtime pay as required by California Labor Code Section 1815. CONTRACTOR and any subcontractor shall, as a penalty to the CITY, forfeit twenty-five dollars (\$25) for each worker employed in the

execution of the contract by the respective contractor or subcontractor for each calendar day during which the worker is required or permitted to work more than 8 hours in any one calendar day and 40 hours in any one calendar week in violation so the provisions of Article 3 of Chapter 1 of Part 7, Division 2 of the California Labor Code, which is incorporated by this reference as though fully set forth herein.

ARTICLE 5. CONTRACT PRICE

- A. CITY shall pay CONTRACTOR for completion of the WORK the sum of \_\_\_\_\_ Dollars (\$\_\_\_\_\_), based on the bid price of same and in accordance with the Contract Documents.
- B. Notwithstanding any provisions herein, CONTRACTOR shall not be paid any compensation until such time as CONTRACTOR has on file with the City Finance Department a current W-9 form available from the IRS website ([www.irs.gov](http://www.irs.gov)) and has obtained a currently valid Petaluma business license pursuant to the Petaluma Municipal Code.
- C. In no case shall the total contract compensation exceed \_\_\_\_\_ Dollars (\$\_\_\_\_\_ ) without the prior written authorization by the City Manager. Further, no compensation for a section or work program component attached with a specific budget shall be exceeded without the prior written authorization of the City Manager.

ARTICLE 6. BONDS

- A. Before entering upon the performance of the WORK, the CONTRACTOR shall furnish Performance and Labor and Materials Bonds, each in the amount of one hundred percent (100%) of the contract price, as security for the faithful performance and payment of all the CONTRACTOR's obligations under the Contract Documents. These Bonds shall remain in effect at least until one year after the date of Completion, except as otherwise provided by Law or Regulation or by the Contract Documents. The CONTRACTOR shall also furnish such other Bonds as are required by the Supplementary General Conditions.
- B. The CONTRACTOR shall guarantee the WORK to be free of defects in material and workmanship for a period of one (1) year following the CITY's acceptance of the WORK. The CONTRACTOR shall agree to make, at the CONTRACTOR's own expense, any repairs or replacements made necessary by defects in material or workmanship which become evident within the one-year guarantee period. The CONTRACTOR's guarantee against defects required by this provision shall be secured by a Maintenance Bond, in the amount of ten percent (10%) of the contract price, which shall be delivered by the CONTRACTOR to the CITY prior to acceptance of the WORK. The Maintenance Bond shall remain in force for one (1) year from the date of acceptance of the contracted WORK. The CONTRACTOR shall make all repairs and replacements within the time required during the guarantee period upon receipt of written order from the ENGINEER. If the CONTRACTOR fails to make the repairs and replacements within the required time, the CITY may do the work and the CONTRACTOR and the

CONTRACTOR's surety for the Maintenance Bond shall be liable to the CITY for the cost. The expiration of the Maintenance Bond during the one-year guarantee period does not operate to waive or void the one-year guarantee, as set forth herein.

- C. The form of the Performance, Labor and Materials, and Maintenance Bonds are provided by the CITY as part of the Contract Documents. Only such bond forms provided by the CITY are acceptable and shall be executed by such sureties as are named in the current list of "Companies Holding Certificates of Authority as Acceptable Sureties on Federal bonds and as Acceptable Reinsuring Companies" as published in Circular 570 (amended) by the Audit Staff, Bureau of Government Financial Operations, U.S. Treasury Department. All Bonds signed by an agent must be accompanied by a certified copy of such agent's authority to act.
- D. If the surety on any Bond furnished by the CONTRACTOR is declared a bankrupt or becomes insolvent or its right to do business is terminated in any state where any part of the WORK is located, the CONTRACTOR shall within 7 days thereafter substitute another Bond and surety, which must be acceptable to the CITY.
- E. All Bonds required by the Contract Documents to be purchased and maintained by CONTRACTOR shall be obtained from surety companies that are duly licensed or authorized in the State of California to issue Bonds for the limits so required. Such surety companies shall also meet such additional requirements and qualifications as may be provided in the Supplementary General Conditions.

#### ARTICLE 7. PAYMENT PROCEDURES

CONTRACTOR shall submit Applications for Payment in accordance with Article 14 of the General Conditions. Applications for Payment will be processed by ENGINEER as provided in the General Conditions.

#### ARTICLE 8. RETENTION

- A. Pursuant to Section 22300 of the California Public Contract Code, the CONTRACTOR may substitute securities for any money withheld by the CITY to ensure performance under the Contract. At the request and expense of the CONTRACTOR, securities equivalent to the amount withheld shall be deposited with the CITY or with a state or federally chartered bank in California as to the escrow agent, who shall return such securities to the CONTRACTOR upon satisfactory completion of the Contract.
- B. Alternatively, the CONTRACTOR may request and the CITY shall make payment of retentions earned directly to the escrow agent at the expense of the CONTRACTOR. At the expense of the CONTRACTOR, the CONTRACTOR may direct the investment of the payments into securities and the CONTRACTOR shall receive the interest earned on the investments upon the same terms provided for in this section for securities deposited by the CONTRACTOR. The CONTRACTOR shall be responsible for paying all fees for the expenses incurred by the escrow account and all expenses of the CITY. These expenses and payment terms shall be determined by the CITY's Finance Director or his/her designee and the escrow agent. Upon satisfactory completion of the Contract, the

CONTRACTOR shall receive from the escrow agent all securities, interest, and payments received by the escrow agent from the CITY, pursuant to the terms of this section. The CONTRACTOR shall pay to each subcontractor, not later than 20 days of receipt of the payment, the respective amount of interest earned, net of costs attributed to retention withheld from each subcontractor, on the amount of retention withheld to ensure the performance of the CONTRACTOR.

- C. Securities eligible for investment under Section 22300 shall be limited to those listed in Section 16430 of the Government Code and to bank or savings and loan certificates of deposit, interest-bearing demand deposit accounts, standby letters of credit, or any other security mutually agreed to by the CONTRACTOR and the CITY.

#### ARTICLE 9. CONTRACT DOCUMENTS

The Contract Documents which comprise the entire agreement between the CITY and the CONTRACTOR concerning the WORK consist of this Agreement and the following attachments to this Agreement:

- Notice Inviting Bids
- Instructions to Bidders
- Bid Forms including the Bid, Bid Schedule(s), Information Required of Bidder, Bid Bond, and all required certificates and affidavits
- Labor and Materials Bond
- Performance Bond
- Maintenance Bond
- General Conditions
- Supplementary General Conditions (if any)
- Specifications
- Special Provisions
- Drawings
- Federal Wage Rates dated \_\_\_\_\_ (if applicable)
- Form FHWA-1273 (if applicable)
- Addenda (if any)
- Change Orders which may be delivered or issued after Effective Date of the Agreement and are not attached hereto.

There are no Contract Documents other than those listed in this Article 9. The Contract Documents may only be amended by Change Order as provided in Paragraph 3.5 of the General Conditions.

#### ARTICLE 10. INSURANCE

The applicable insurance requirements, as approved by the City's Risk Manager, are set forth in **Exhibit B**, attached hereto and incorporated by reference herein. *[City use: check one.]*

## ARTICLE 11. INDEMNIFICATION

- A. CONTRACTOR shall indemnify, defend with counsel acceptable to CITY, and hold harmless to the full extent permitted by law, CITY and its officers, officials, employees, agents and volunteers from and against any and all alleged liability, loss, damage, claims, expenses and costs (including, without limitation, attorney fees and costs and fees of litigation) (collectively, "Liability") of every nature arising out of or in connection with CONTRACTOR's performance of the WORK or its failure to comply with any of its obligations contained in this Agreement, except such Liability caused by the active negligence, sole negligence or willful misconduct of the CITY. Such indemnification by the CONTRACTOR shall include, but not be limited to, the following:
1. Liability or claims resulting directly or indirectly from the negligence or carelessness of the CONTRACTOR, its subcontractors, employees, or agents in the performance of the WORK, or in guarding or maintaining the same, or from any improper materials, implements, or appliances used in its construction, or by or on account of any act or omission of the CONTRACTOR, its employees, or agents;
  2. Liability or claims arising directly or indirectly from bodily injury, occupational sickness or disease, or death of the CONTRACTOR's, or Supplier's own employees, or agents engaged in the WORK resulting in actions brought by or on behalf of such employees against the CITY and/or the ENGINEER;
  3. Liability or claims arising directly or indirectly from or based on the violation of any Laws or Regulations, whether by the CONTRACTOR, its subcontractors, employees, or agents;
  4. Liability or claims arising directly or indirectly from the use or manufacture by the CONTRACTOR, its subcontractors, employees, or agents in the performance of this Agreement of any copyrighted or uncopyrighted composition, secret process, patented or unpatented invention, article, or appliance, unless otherwise specified stipulated in this Agreement;
  5. Liability or claims arising directly or indirectly from the breach of any warranties, whether express or implied, made to the CITY or any other parties by the CONTRACTOR, its subcontractors, employees, or agents;
  6. Liability or claims arising directly or indirectly from the willful misconduct of the CONTRACTOR, its subcontractors, employees, or agents;
  7. Liability or claims arising directly or indirectly from any breach of the obligations assumed in this Agreement by the CONTRACTOR;
  8. Liability or claims arising directly or indirectly from, relating to, or resulting from a hazardous condition created by the CONTRACTOR, Subcontractors, Suppliers, or any of their employees or agents, and;
  9. Liability or claims arising directly, or indirectly, or consequentially out of any action, legal or equitable, brought against the CITY, the ENGINEER, their consultants, subconsultants, and the officers, directors, employees and agents of each or any of them, to the extent caused by the CONTRACTOR's use of any premises acquired by permits, rights of way, or easements, the Site, or any land or area contiguous thereto or its performance of the WORK thereon.

- B. The CONTRACTOR shall reimburse the CITY for all costs and expenses, (including but not limited to fees and charges of engineers, architects, attorneys, and other professionals and court costs of appeal) incurred by said CITY in enforcing the provisions of this Paragraph.
- C. The indemnification obligation under this Article 11 shall be in addition to, and shall not be limited in any way by any limitation on the amount or type of insurance carried by CONTRACTOR or by the amount or type of damages, compensation, or benefits payable by or for the CONTRACTOR or any Subcontractor or other person or organization under workers' compensation acts, disability benefit acts, or other employee benefit acts. The CONTRACTOR's responsibility for such defense and indemnity obligations shall survive the termination or completion of this Agreement for the full period of time allowed by law.
- D. Pursuant to California Public Contract Code Section 9201, City shall timely notify Contractor of receipt of any third-party claim relating to this Agreement.

ARTICLE 12. DISCLAIMER AND INDEMNITY  
CONCERNING LABOR CODE SECTION 6400

By executing this agreement the CONTRACTOR understands and agrees that with respect to the WORK, and notwithstanding any provision in this contract to the contrary, the CONTRACTOR, and/or its privities, including, without limitation, subcontractors, suppliers and other engaged by the CONTRACTOR in the performance of the WORK shall be "employers" for purposes of California Labor Code Section 6400 and related provisions of law, and that neither CITY nor its officials, officers, employees, agents, volunteers or consultants shall be "employers" pursuant to California Labor Code Section 6400 with respect to the performance of the WORK by the CONTRACTOR and/or its privities.

The CONTRACTOR shall take all responsibility for the WORK, shall bear all losses and damages directly or indirectly resulting to the CONTRACTOR, any subcontractors, the CITY, its officials, officers, employees, agents, volunteers and consultants, on account of the performance or character of the WORK, unforeseen difficulties, accidents, or occurrences of other causes predicated on active or passive negligence of the CONTRACTOR or of any subcontractor, including, without limitation, all losses, damages or penalties directly or indirectly resulting from exposure to hazards in performance of the WORK in violation of the California Labor Code. The CONTRACTOR shall indemnify, defend and hold harmless the CITY, its officials, officers, employees, agents, volunteers and consultants from and against any or all losses, liability, expense, claim costs (including costs of defense), suits, damages and penalties (including, without limitation, penalties pursuant to the California Labor Code) directly or indirectly resulting from exposure to hazards in performance of the WORK in violation of the California Labor Code, except such liability or costs caused by the active negligence, sole negligence or willful misconduct of the CITY.

ARTICLE 13. INDEPENDENT CONTRACTOR

It is understood and agreed that in the performance of this Agreement, CONTRACTOR (including its employees and agents) is acting in the capacity of an independent contractor, and not as an agent or employee of the CITY. CONTRACTOR has full control over the means and methods of performing said services and is solely responsible for its acts and omissions, including the acts and omissions of its employees and agents.

ARTICLE 14. SUBCONTRACTORS

CONTRACTOR must obtain the CITY's prior written consent for subcontracting any WORK pursuant to this Agreement. Any such subcontractor shall comply, to the extent applicable, with the terms and conditions of this Agreement. Any agreement between CONTRACTOR and a subcontractor pursuant to this Agreement shall provide that the subcontractor procure and maintain insurance coverage as required herein and which shall name CITY as an additional insured.

ARTICLE 15. COMPLIANCE WITH LAWS/NON-DISCRIMINATION

CONTRACTOR shall comply with all applicable local, state and federal laws, regulations and ordinances in the performance of this Agreement. CONTRACTOR shall not discriminate in the provision of service or in the employment of persons engaged in the performance of this Agreement on account of race, color, national origin, ancestry, religion, gender, marital status, sexual orientation, age, physical or mental disability in violation of any applicable local, state or federal laws or regulations.

ARTICLE 16. NOTICES

All notices required or permitted by this Agreement, including notice of change of address, shall be in writing and given by personal delivery or sent postage prepaid and addressed to the parties intended to be notified, as set forth herein. Notice shall be deemed given as of the date of delivery in person or as of the date deposited in any post office or post office box regularly maintained by the United States Postal Service, unless otherwise stated herein. Notice shall be given as follows:

CITY:	City Clerk City of Petaluma Post Office Box 61 Petaluma, California 94953 Telephone: (707) 778-4360
-------	---

CONTRACTOR:	_____ (Contact Name)
	_____ (Business Name)
	_____ (Address)



\_\_\_\_\_  
(City, State, Zip)

\_\_\_\_\_  
(Telephone)

\_\_\_\_\_  
(E-mail)

#### ARTICLE 17. GOVERNING LAW/VENUE

This Agreement shall be construed and its performance enforced under California law. Venue shall be in the Superior Court of the State of California in the County of Sonoma.

#### ARTICLE 18. NON-WAIVER

The CITY's failure to enforce any provision of this Agreement or the waiver of any provision in a particular instance shall not be construed as a general waiver of any part of such provision. The provision shall remain in full force and effect.

#### ARTICLE 19. THIRD PARTY BENEFICIARIES

The Parties do not intend, by any provision of this Agreement, to create in any third party any benefit or right owed by one party, under the terms and conditions of this Agreement, to the other party.

#### ARTICLE 20. ASSIGNMENT

No assignment by a party hereto of any rights under or interests in the Contract Documents will be binding on another party hereto without the written consent of the party sought to be bound; and specifically but without limitation monies that may become due and monies that are due may not be assigned without such consent (except to the extent that the effect of this restriction may be limited by law), and unless specifically stated to the contrary in any written consent to an assignment, no assignment will release or discharge the assignor from any duty or responsibility under the Contract Documents.

CITY and CONTRACTOR each binds itself, its partners, successors, assigns and legal representatives to the other party hereto, its partners, successors, assigns and legal representatives in respect of all covenants, agreements and obligations contained in the Contract Documents.

#### ARTICLE 21. SEVERABILITY

If any term or portion of this Agreement is held to be invalid, illegal, or otherwise enforceable by a court of competent jurisdiction, the remaining provisions of this Agreement shall continue in full force and effect.

IN WITNESS WHEREOF, CITY and CONTRACTOR have caused this Agreement to be executed the day and year first above written.

CITY

CONTRACTOR \_\_\_\_\_

\_\_\_\_\_  
City Manager

By \_\_\_\_\_  
(CORPORATE SEAL)

ATTEST:

Attest: \_\_\_\_\_

\_\_\_\_\_  
City Clerk

Address for giving notices:  
\_\_\_\_\_

APPROVED AS TO FORM:

\_\_\_\_\_  
City Attorney

Agent for service of process:  
\_\_\_\_\_  
\_\_\_\_\_  
\_\_\_\_\_

\_\_\_\_\_  
License Number

\_\_\_\_\_  
Taxpayer I.D. Number

\_\_\_\_\_  
Petaluma Business Tax Certificate Number

file name:

END OF AGREEMENT

AGREEMENT CERTIFICATE  
(if Corporation)

STATE OF CALIFORNIA    )  
  ) ss:  
COUNTY OF                    )

I HEREBY CERTIFY that a meeting of the Board of Directors of the \_\_\_\_\_  
\_\_\_\_\_ a  
corporation existing under the laws of the State of \_\_\_\_\_, held on  
\_\_\_\_\_, 20\_\_\_\_, the following resolution was duly passed and adopted:

“RESOLVED, that \_\_\_\_\_, as \_\_\_\_\_  
President of the Corporation, be and is hereby authorized to execute the  
Agreement dated \_\_\_\_\_, 20\_\_\_\_, by and between  
this Corporation and \_\_\_\_\_ and that his/her execution  
thereof, attested by the Secretary of the Corporation, and with the Corporate Seal  
affixed, shall be the official act and deed of this Corporation.”

I further certify that said resolution is now in full force and effect.

IN WITNESS WHEREOF, I have hereunto set my hand and affixed the official seal of  
the corporation this \_\_\_\_\_, day of \_\_\_\_\_, 20\_\_\_\_.

\_\_\_\_\_  
Secretary

(SEAL)

AGREEMENT CERTIFICATE  
(if Partnership)

STATE OF CALIFORNIA    )  
  ) ss:  
COUNTY OF                            )

I HEREBY CERTIFY that a meeting of the Partners of the \_\_\_\_\_  
\_\_\_\_\_ a partnership existing under the laws of the State of \_\_\_\_\_, held on \_\_\_\_\_, 20\_\_\_\_, the following resolution was duly passed and adopted:

“RESOLVED, that \_\_\_\_\_, as the General Partner of the Partnership, be and is hereby authorized to execute the Agreement dated \_\_\_\_\_, 20\_\_\_\_, by and between this Partnership and \_\_\_\_\_ and that his/her execution thereof, attested by the \_\_\_\_\_ shall be the official act and deed of this Partnership.”

I further certify that said resolution is now in full force and effect.

IN WITNESS WHEREOF, I have hereunto set my hand this \_\_\_\_\_ day of \_\_\_\_\_, 20\_\_\_\_.

\_\_\_\_\_  
Partner

(SEAL)

AGREEMENT CERTIFICATE  
(if Joint Venture)

STATE OF CALIFORNIA    )  
  ) ss:  
COUNTY OF                    )

I HEREBY CERTIFY that a meeting of the Principals of the \_\_\_\_\_  
\_\_\_\_\_  
\_\_\_\_\_ a  
joint venture existing under the laws of the State of \_\_\_\_\_, held  
on \_\_\_\_\_, 20\_\_\_\_, the following resolution was duly passed and adopted:

“RESOLVED,     that \_\_\_\_\_,  
as \_\_\_\_\_, of the joint venture, be and is hereby authorized to execute  
the Agreement dated \_\_\_\_\_, 20\_\_\_\_, by and between this Joint Venture  
and \_\_\_\_\_ and that his/her execution  
thereof, attested by the \_\_\_\_\_ shall be the official act and deed  
of this Joint Venture.”

I further certify that said resolution is now in full force and effect.

IN WITNESS WHEREOF, I have hereunto set my hand this \_\_\_\_\_, day of  
\_\_\_\_\_, 20\_\_\_\_.

\_\_\_\_\_  
Managing Partner

(SEAL)

**FAITHFUL PERFORMANCE BOND**

WHEREAS, the City Council of the City of Petaluma, State of California, and \_\_\_\_\_ (hereinafter designated as "Principal") have entered into an agreement whereby Principal agrees to install and complete certain designated public improvements, which said agreement, dated \_\_\_\_\_, 20\_\_\_\_, and identified as project \_\_\_\_\_, is hereby referred to and made a part hereof; and,

WHEREAS, said Principal is required under the terms of said agreement to furnish a bond for the faithful performance of said agreement.

NOW, THEREFORE, WE, the Principal and \_\_\_\_\_, duly authorized to transact business under the laws of the State of California, as Surety, are held and firmly bound unto the City of Petaluma, hereinafter called "City," in the penal sum of \_\_\_\_\_ Dollars (\$\_\_\_\_) lawful money of the United States, for payment of which sum well and truly to be made, we bind ourselves, our heirs, successors, executors, and administrators, jointly and severally, firmly by these present. The conditions of this obligation are such that if the above-bound Principal, the Principal's heirs, executors, administrators, successors or assigns, shall in all things stand to and abide by, and well and truly keep and perform the covenants, conditions and provisions in the said agreement and any alteration thereof made as therein provided, on his or their part, to be kept and performed at the time and in the manner therein specified, and in all respects according to their true intent and meaning, and shall indemnify and save harmless the City of Petaluma, its officers, agents, employees, and volunteers, as therein stipulated, then this obligation shall become null and void; otherwise it shall be and remain in full force and effect.

As a part of this obligation secured hereby and in addition to the face amount specified therefore, there shall be included costs and reasonable expenses and fees, including reasonable attorney's fees, incurred by the City in successfully enforcing such obligation, all to be taxed as costs and included in any judgment rendered.

The Surety hereby stipulates and agrees that no change, extension of time, alteration or addition to the terms of this agreement or to the work to be performed thereunder or the specifications accompanying the same shall in anywise affect its obligations on this bond, and it does hereby waive notice of any such change, extension of time, alteration or addition to the terms of the agreement or to the work or to the specifications.

And the said Surety, for value received, hereby stipulates and agrees that upon termination of the Contract for cause, the Obligee reserves the right to refuse tender of the Principal by the Surety to complete the Contract work.

IN WITNESS WHEREOF, this instrument has been duly executed by the Principal and Surety above named, on \_\_\_\_\_, 20\_\_\_\_\_.

PRINCIPAL

SURETY

By \_\_\_\_\_

By \_\_\_\_\_

\_\_\_\_\_  
Name and Title

\_\_\_\_\_  
Name and Title

\_\_\_\_\_  
Address

\_\_\_\_\_  
City State Zip

\_\_\_\_\_  
Phone Number

###

NOTE: No substitution or revision to this bond form will be accepted. Be sure that all bonds submitted have a certified copy of the bonding agent's power of attorney attached. Also verify that Surety is an "Admitted Surety" (i.e., qualified to do business in California), and attach proof of verification (website printout from the California Department of Insurance website (<http://www.insurance.ca.gov/docs/index.html>) or certificate from County Clerk).

APPROVED AS TO AMOUNT:

APPROVED AS TO FORM:

\_\_\_\_\_  
City Manager

\_\_\_\_\_  
City Attorney

END OF FAITHFUL PERFORMANCE BOND

**LABOR AND MATERIALS BOND**

WHEREAS, the City of Petaluma, State of California, and \_\_\_\_\_ (hereinafter designated as “Principal”) have entered into an agreement whereby the Principal agrees to install and complete certain designated public improvements, which said agreements, dated \_\_\_\_\_, 20\_\_\_\_, and identified as project \_\_\_\_\_, is hereby referred to and made a part hereof; and,

WHEREAS, under the terms of said agreement Principal is required before entering upon the performance of the work, to file a good and sufficient payment bond with the City of Petaluma, to secure the claims to which reference is made in Title 15 (commencing with Section 3082) of Part 4 of Division 3 of the Civil Code of the State of California.

NOW, THEREFORE, said Principal and the undersigned, duly authorized to transact business under the laws of the State of California, as corporate surety, are held firmly bound unto the City of Petaluma, and all contractors, subcontractors, laborers, materialmen and other persons employed in the performance of the aforesaid agreement and referred to in the aforesaid Civil Code of the State of California, in the sum of \_\_\_\_\_ Dollars (\$\_\_\_\_\_) for materials furnished or labor thereon of any kind, or for amounts due under the Unemployment Insurance Act with respect to such work or labor, that said surety will pay the same in an amount not exceeding the amount hereinabove set forth, and also in case suit is brought upon this bond, will pay, in addition to the face amount thereof, costs and reasonable expenses and fees, including reasonable attorney's fees, incurred by City in successfully enforcing such obligation, to be awarded and fixed by the Court, and to be taxed as costs and to be included in the judgment therein rendered.

It is hereby expressly stipulated and agreed that this bond shall inure to the benefit of any and all persons, companies and corporations entitled to file claims under Title 15 (commencing with section 3082) of Part 4 of Division 3 of the Civil Code, so as to give a right of action to them or their assigns in any suit brought upon this bond.

Should the condition of this bond be fully performed, then this obligation shall become null and void, otherwise it shall be and remain in full force and effect.

THE SURETY hereby stipulates and agrees that no change, extension of time, alteration or addition to the terms of said agreement or the specifications accompanying the same shall in any



manner affect its obligations on this bond, and it does hereby waive notice of any such change, extension, alteration or addition.

IN WITNESS WHEREOF, this instrument has been duly executed by the Principal and surety above named, on \_\_\_\_\_, 20\_\_\_\_.

PRINCIPAL

SURETY

By \_\_\_\_\_

By \_\_\_\_\_

\_\_\_\_\_  
Name and Title

\_\_\_\_\_  
Name and Title

\_\_\_\_\_  
Address

\_\_\_\_\_  
City State Zip

\_\_\_\_\_  
Phone

###

NOTE: No substitution or revision to this bond form will be accepted. Be sure that all bonds submitted have a certified copy of the bonding agent's power of attorney attached. Also verify that Surety is an "Admitted Surety" (i.e., qualified to do business in California), and attach proof of verification (website printout from the California Department of Insurance website (<http://www.insurance.ca.gov/docs/index.html>) or certificate from County Clerk)..

APPROVED AS TO AMOUNT:

APPROVED AS TO FORM:

\_\_\_\_\_  
City Manager

\_\_\_\_\_  
City Attorney

END OF LABOR AND MATERIALS BOND

## MAINTENANCE BOND

WHEREAS, the City Council of the City of Petaluma (“City”) and \_\_\_\_\_, (hereinafter designated as “Principal”) have entered into an agreement whereby Principal agrees to install and complete certain designated public improvements, which said agreement, dated \_\_\_\_\_, 20\_\_\_\_\_, and identified as project \_\_\_\_\_, is hereby referred to and made a part hereof; and,

WHEREAS, said Principal is required under the terms of said contract to furnish a maintenance bond for the correction of any defects due to defective materials or workmanship in the work performed under said agreement.

NOW, THEREFORE, we the Principal and \_\_\_\_\_ as Surety, are held and firmly bound unto the City of Petaluma in the penal sum of \_\_\_\_\_ Dollars (\$\_\_\_\_\_), lawful money of the United States for the payment of which sum well and truly to be made, we bind ourselves, our heirs, executors, administrators, successors, and assigns jointly and severally, firmly by these presents.

THE CONDITIONS OF THIS OBLIGATION ARE SUCH that if, during a maintenance period of one (1) year from the date of acceptance of the contracted work, the Principal upon receiving written notice of a need for repairs which are directly attributable to defective materials or workmanship, shall diligently take the necessary steps to correct said defects within seven (7) days from the date of said notice, then this obligation shall be null and void; otherwise it shall remain in full force and effect.

As part of this obligation secured hereby and in addition to the face amount specified therefor, there shall be included costs and reasonable expenses and fees, including reasonable attorney’s fees, incurred by the City in successfully enforcing such obligation, all to be taxed as costs and included in any judgment rendered.

The Surety hereby stipulates and agrees that no change, extension of time, alteration or addition to the terms of this agreement or to the work to be performed thereunder or the specifications accompanying the same shall in anywise affect its obligations on this bond, and it does hereby waive notice of any such change, extension of time, alteration or addition to the terms of the agreement or to the work or to the specifications.

IN WITNESS WHEREOF, this instrument has been duly executed by the Principal and Surety above named, on \_\_\_\_\_, 20\_\_\_\_.

PRINCIPAL

SURETY

By\_\_\_\_\_

By\_\_\_\_\_

\_\_\_\_\_  
Name and Title

\_\_\_\_\_  
Name and Title

\_\_\_\_\_  
Address

\_\_\_\_\_  
City State Zip

\_\_\_\_\_  
Phone Number

###

NOTE: No substitution or revision to this bond form will be accepted. Be sure that all bonds submitted have a certified copy of the bonding agent’s power of attorney attached. Also verify that Surety is an “Admitted Surety” (i.e., qualified to do business in California), and attach proof of verification (website printout from the California Department of Insurance website (<http://www.insurance.ca.gov/docs/index.html>) or certificate from County Clerk).

APPROVED AS TO AMOUNT:

APPROVED AS TO FORM:

\_\_\_\_\_  
City Manager

\_\_\_\_\_  
City Attorney

END OF MAINTENANCE BOND

NOTARIAL ACKNOWLEDGEMENT OF ATTORNEY-IN-FACT OF SURETY

STATE OF CALIFORNIA )  
 ) SS.  
COUNTY OF SONOMA )

On \_\_\_\_\_ before me, a Notary Public, personally appeared \_\_\_\_\_, personally known to me (or proved to me on the basis of satisfactory evidence) to be the person(s) whose name(s) is/are subscribed to the within instrument and acknowledged to me that he/she/they executed the same in his/her/their authorized capacity(ies), and that by his/her/their signature(s) on the instrument the person(s), or the entity upon behalf of which the person(s) acted, executed the instrument.

WITNESS my hand and official seal.

\_\_\_\_\_  
Notary Public

(Seal)

**SECTION VI**  
**CITY STANDARD DRAWINGS**

Median  $W + SHY = X$   
 Planted  $8 + SHY = 10.0'$   
 Traffic Control  $2 + SHY = 4.0'$

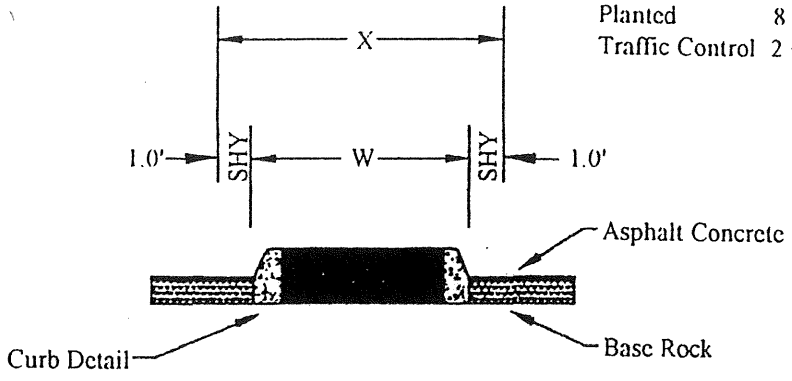

DETAIL "A"

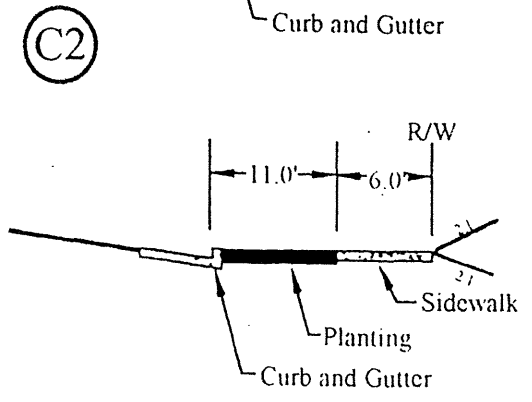
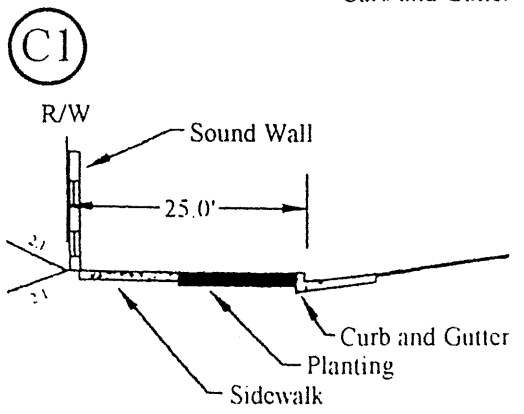
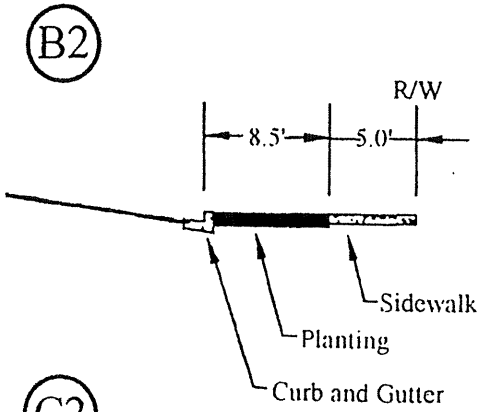
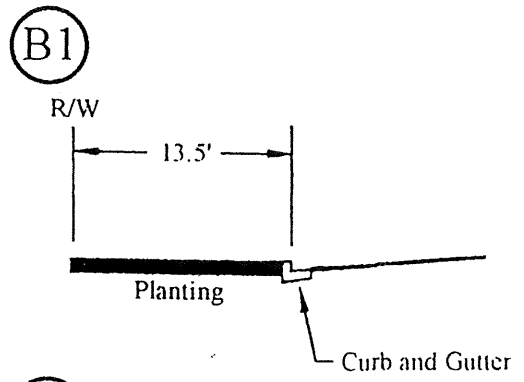
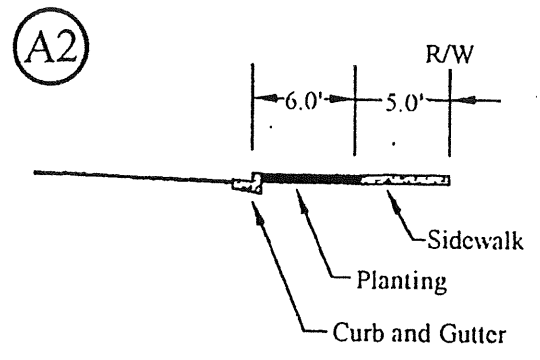
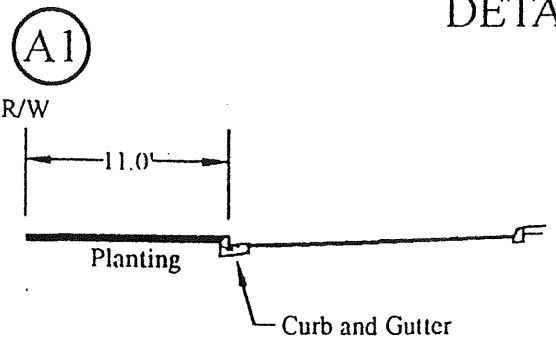

**CITY OF PETALUMA**  
 Department of Engineering  
 22 Bassett Street - Petaluma California 94952  
 707 778 1304 Fax 707 778 4437  
 Approved By  
*Thomas S. Hargis*  
 Thomas S. Hargis, P.E., C.E.

**STANDARD STREET CONFIGURATION**  
 Details



Drawn By  
 Butch Smith  
 Scale  
 N.T.S.  
 Date  
 March 28th 1997  
 File Number  
 S.D. 1 SSP 0000 0000 0000

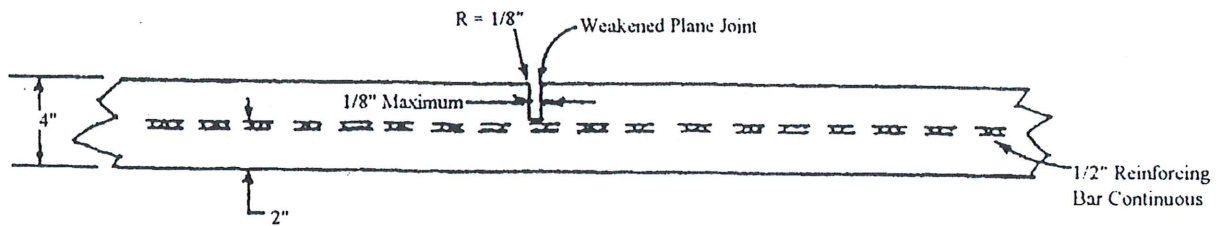

1. Compact all Subgrade to Minimum of 92% at 4 to 6 Percentage Points over opt. Moisture. (See STANDARD DETAIL SPECIFICATION NO. 41, Section 202.2)
2. Flowline of Gutter is 2" below the Lip of Gutter and 2-1/4" below the Edge of Pavement.
3. Top of Curb is 6" above Flowline; i.e. 6" Curb Height.
4. Concrete to be Class "B" (5-Sack per Cubic Yard) with 2" to 4" Slump. If placed by *Extrusion Machine*, concrete to be Class "B" (5-1/2-Sack per Cubic Yard) (See STANDARD DETAIL SPECIFICATION NO.41 Section 202.8)
5. Monolithic Curb, Gutter and Sidewalk require 1/4" *Premold Joint Filler* and 4-1/2" x 20" Smooth Steel Dowels every 60'-0", 4-1/2" rebars between Expansion Joints are required where soil is expansive (Adobe-Clay). If placed by *Extrusion Machine*, *Premold Joint filler* not required. Machine pours require 4-1/2" Smooth Steel Dowels at Cold Joints. NO other Steel required.
6. Use one Pound of *Lampblack* per Cubic Yard of Mix.
7. Weakened Plane Joints in Curb, Gutter and Sidewalk shall be placed of intervals not to exceed 20-Feet, the Removable Joint forming Plates shall extend through not less than the upper 1/2" (1-3/4") of Sidewalks and completely through the Curb to at least 2-3/4" below the top of the Gutter.
8. Aggregate under Curb, Gutter, Sidewalk and Driveways shall be 3/4" Maximum size Class 2 Aggregate Sub-Base or 3/4" maximum size Class 2 Aggregate Base.
9. If Calcium Chloride is to be added to the Concrete (On Approval Only), 1/2 Sack Cement per Cubic Yard shall be added for each 1% of Calcium Chloride (CC) not to exceed 2%.



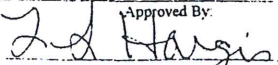

PROFILE - WEAKENED PLANE JOINT

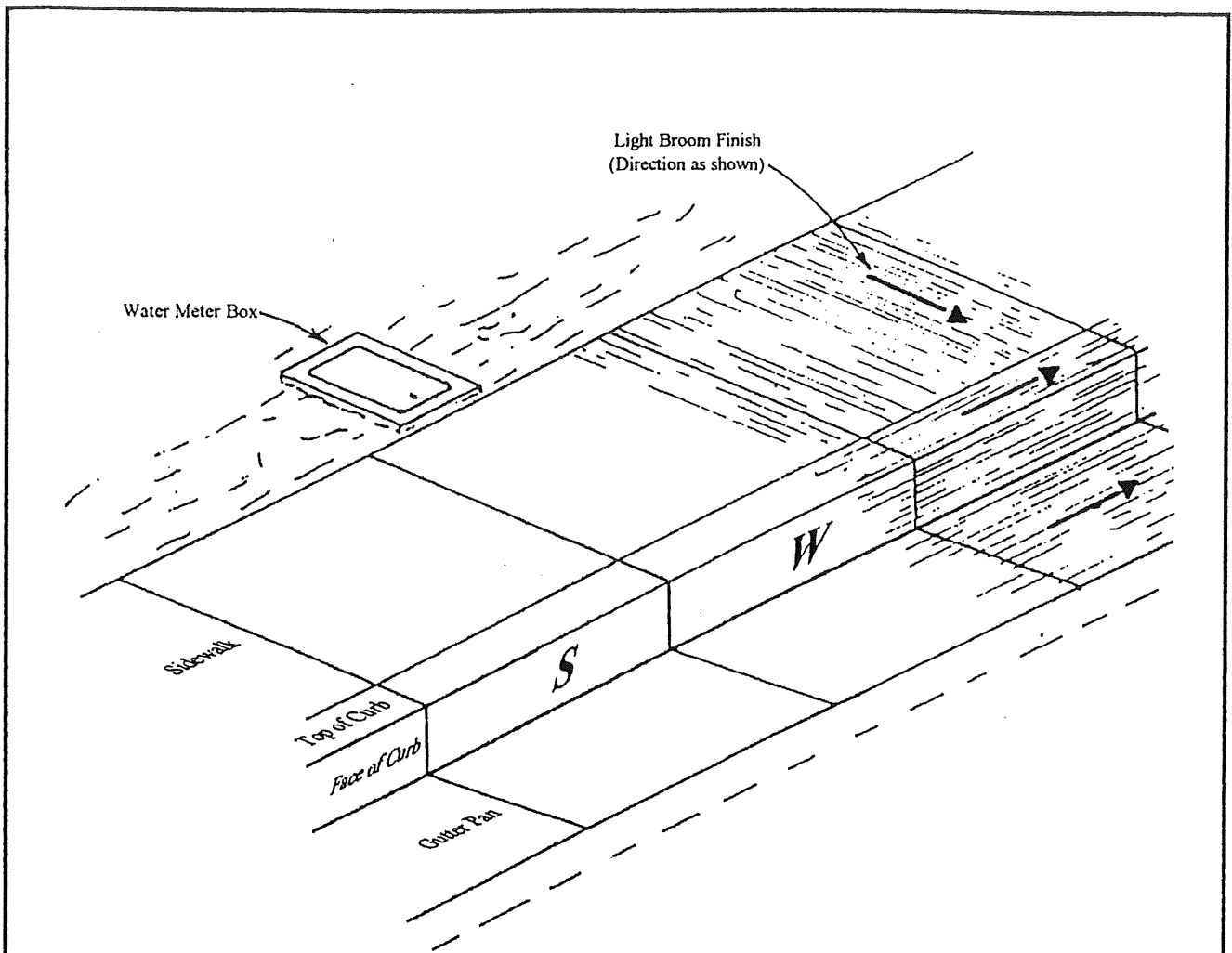
<p><b>CITY OF PETALUMA</b>          Department of Engineering          22 Bassett Street - Petaluma California 94952          707 778 4304 - Fax 707 778 4431</p> <p>Approved By:            Thomas S. Hargis - E.C.F. 22366</p>	<p>Standard Details  <b>CURB, GUTTER          SIDEWALK</b>          General Notes</p>	<p>Drawn By  <b>Butch Smith</b>          Scale  <b>N T S</b>          Date  <b>September 4th 1996</b>          File Number          Std Det SSD0000 202 1 of 2</p>	 <p>Page  <b>202</b></p>
---	---	--	---

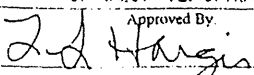

**NOTE:**

1. The Face of Curb shall be stamped with the appropriate letter, directly over the service lateral.  
 "S" = Sanitary Sewer Lateral  
 "W" = Water Service Lateral  
 "D" = Utility Duct Crossing  
 "B" = Water Blow-off behind Sidewalk.
2. Stamps shall be constructed such that they will leave a clear, clean impression at least 3/16" in depth. Letters shall be a minimum of 3-1/2" high but no more than 4" Scratching in letters with sticks or other object will not be allowed.
3. It will be the responsibility of the Underground Contractor to visibly reference all service laterals prior to pouring curb, gutter, and sidewalk.

<p><b>CITY OF PETALUMA</b>          Department of Engineering          22 Bassett Street - Petaluma California 94952          707 778 4304 - Fax 707 778 4437</p> <p>Approved By:            Thomas S. Hargis R.C.E. 22366</p>	<p>Standard Details  <b>CURB MARKINGS</b>          FOR          Service Laterals</p>	<p>Drawn By:  <b>Butch Smith</b>          Scale          N. T. S.          Date          October 30th 1996          File Number          Std Det SSD0000 202 2 of 2</p>	 <p>Page          202</p>
---	--	---	--



### SIDEWALK SECTION

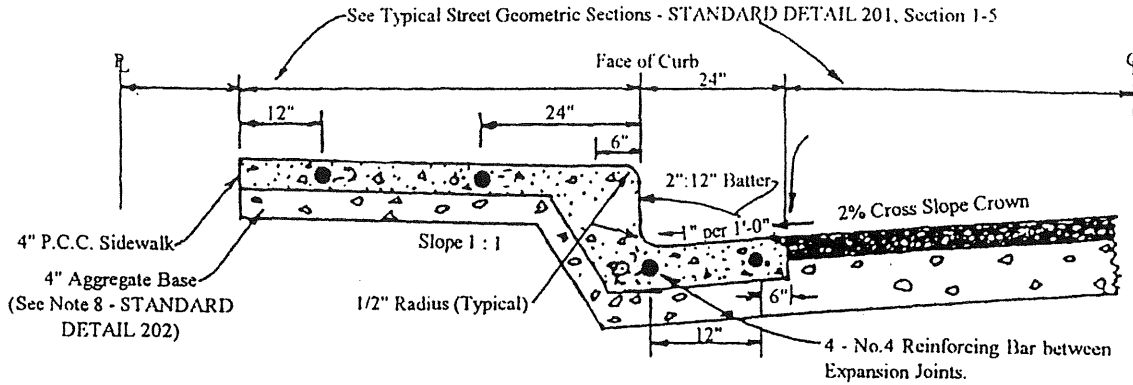

### DRIVEWAY SECTION

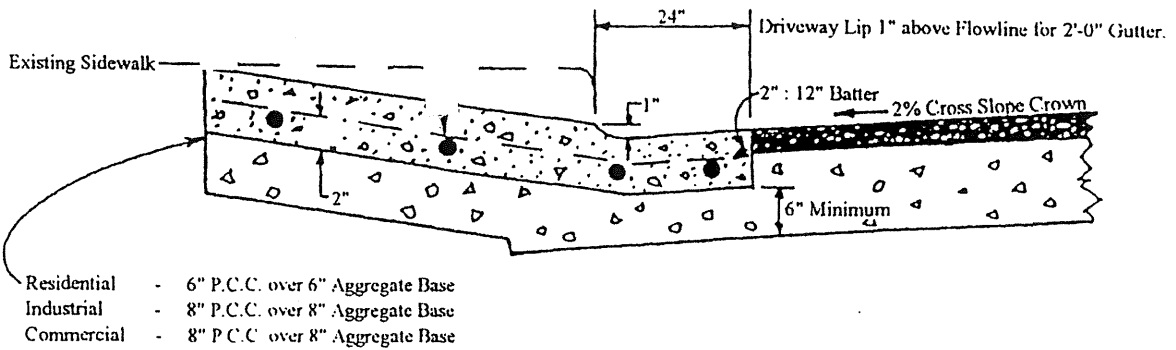

### RESIDENTIAL DRIVEWAY

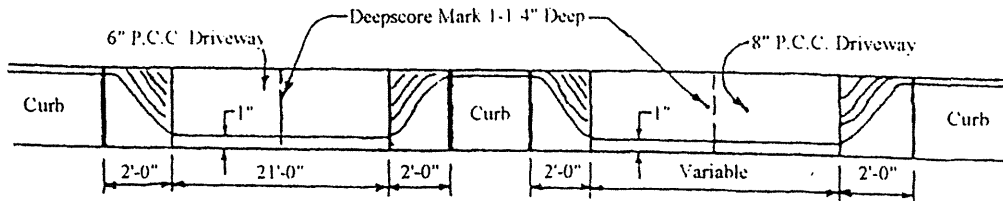

1/4" Expansion Joint each end of Driveway  
(See STANDARD DETAIL 202 Note 5)

### COMMERCIAL DRIVEWAY

CITY OF PETALUMA  
Department of Engineering

22 Bassett Street - Petaluma California 94952  
707 778 4304 - Fax 707 778 4411

Approved By:

*Thomas S. Harris*  
Thomas S. Harris - RCE 2236

Standard Details  
**CURB, GUTTER  
SIDEWALK  
DRIVEWAY**  
X-Section

Drawn By  
Butch Smith

Scale:  
N T S

Date  
February 9th 1997 (Rev.)

File Number

SSD0000 203



Page

203

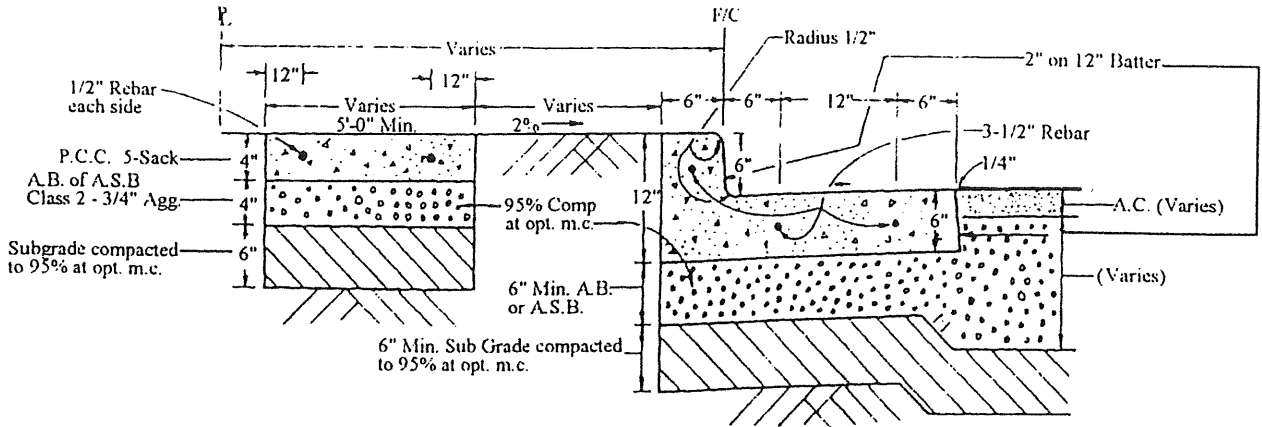

**SIDEWALK, CURB AND GUTTER SECTION WITH PLANTER STRIP "NEW"**

"New" curb and gutter and or driveway approach as per City Standard Detail.

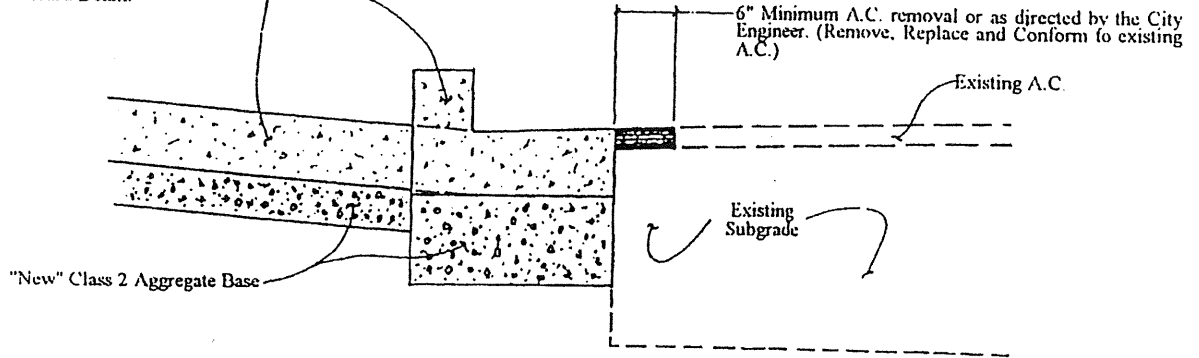

**STREET CONFORM DETAIL AT NEW CURB AND GUTTER OR DRIVEWAYS**

**NOTES:**

**LANDSCAPED AREAS**

Try to save all plants, plants damaged or removed by the contractor shall be replaced "in Kind" at the contractor's expense.

For additional details, See 1984 CALTRANS Standard Plans, Page 85 and 86, drawings N8B and N8C.

1. Expansion joints are required at 60'-0" intervals with 3 each 1/2" diameter Rebar Dowels.
2. Scarify all subgrade and compact to 95% at opt. m.c.
3. Compact A.S.B. or A.B. to 95% at optimum moisture content.
4. Refer to Sidewalk Section.

For expansive soils See City Standard Detail Specification No. 41 paragraph 4102.2 relative compaction.

Contractor must remove a minimum of 6" of A.C. or more at the discretion of the Director of Engineering to form for curb and gutter or Driveway approach.

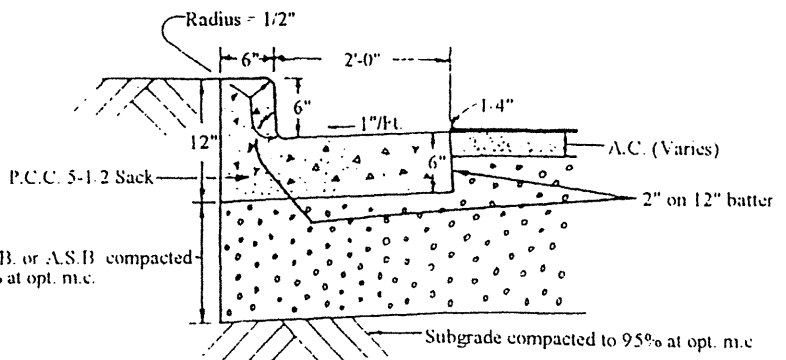

**P.C.C. PLACEMENT BY EXTRUSION MACHINE**

<p><b>CITY OF PETALUMA</b>          Department of Engineering          22 Bassett Street Petaluma California 94952          Phone 707-778-4304 Fax 707-778-4437</p> <p>Approved By  <i>Thomas S. Huggins</i>          Thomas S. Huggins R.C.E. 22366</p>	<p>Standard Details  <b>MISC.</b>  <b>"NEW"</b>  <b>CONSTRUCTION</b>          Sections</p>	<p>Drawn By  <b>Butch Smith</b>          Scale  <b>N. T. S.</b>          Date  <b>February 9th 1998 (Rev)</b>          File Number          Std Det SSIDumber 201.2 of 2</p>	 <p>Page 2 of 2</p>
--	--	--	--

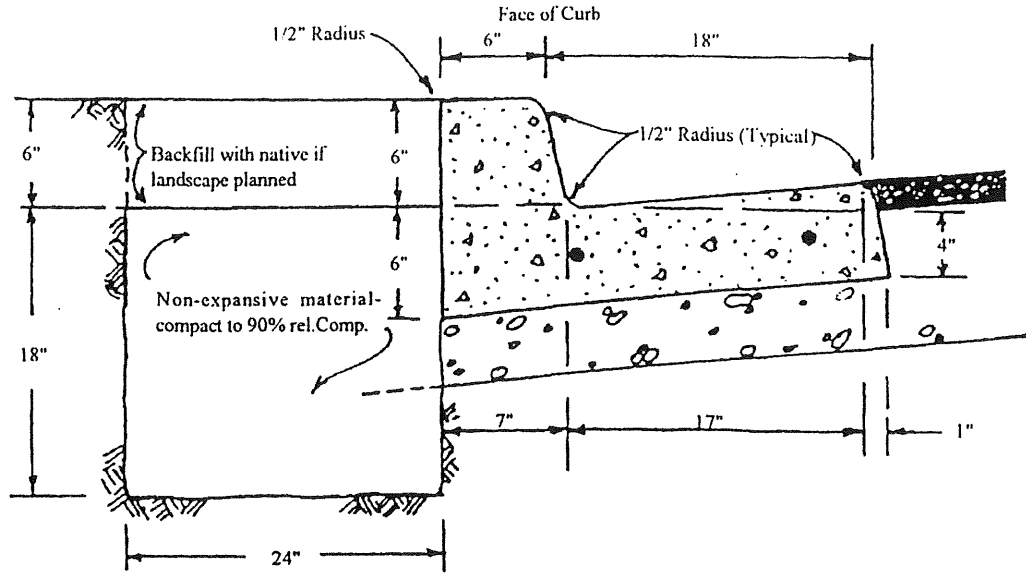

**STANDARD CURB AND CUTTER  
with Non-expansive Backing**

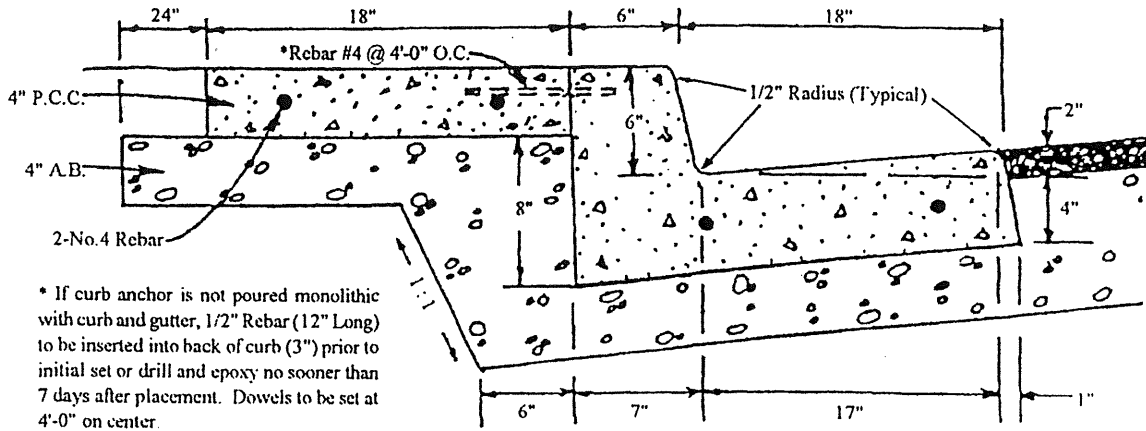

**STANDARD CURB AND CUTTER  
with Curb Anchor**

**NOTE:**

1. Curb and gutter with non-expansive backing or with curb anchor are optional or as directed by the Engineer.
2. Placement of Curb Anchor shall conform to STANDARD DETAIL 203 and DETAIL SPECIFICATION 41, Section 202.8.
3. If non-expansive material is to be used, the Engineer may require testing by an accredited soils lab prior to placement. Sand or pea gravel will not be allowed

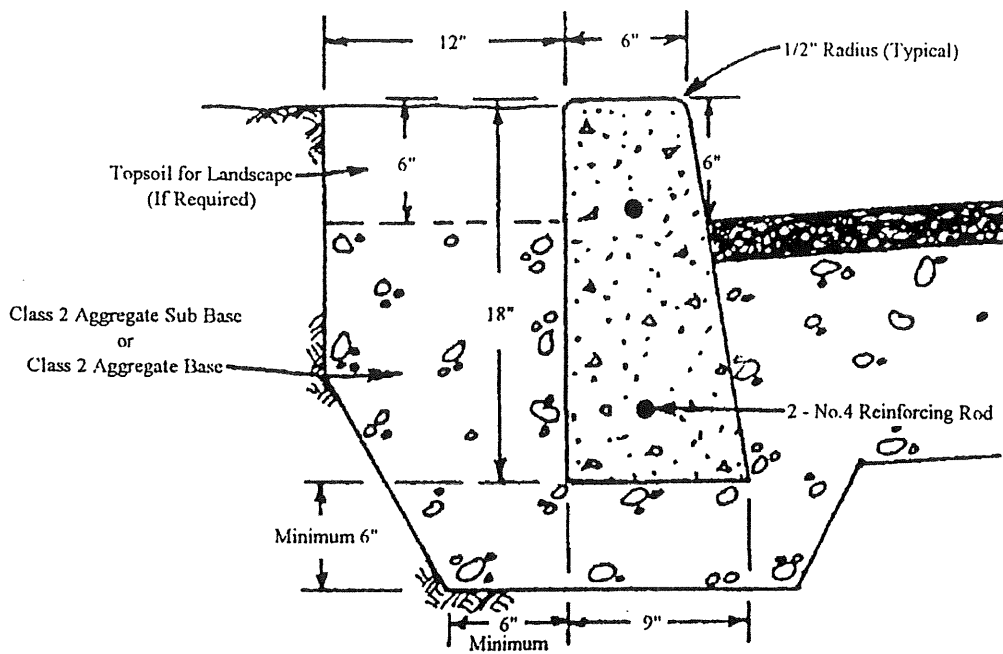

VERTICAL CURB

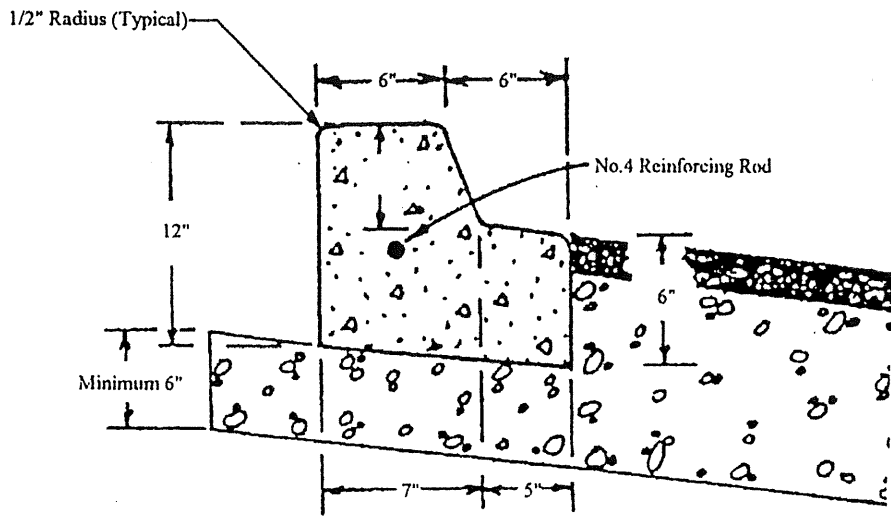

CURB AND FALL AWAY GUTTER

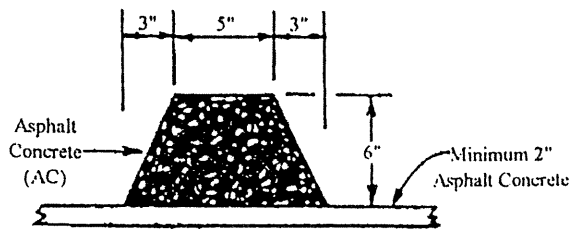

ASPHALT CONCRETE CURB

NOTE:

Asphalt concrete curb to be placed by an acceptable extrusion machine only.

CITY OF PETALUMA  
 Department of Engineering  
 22 Bassett Street - Petaluma California 94952  
 707 778 4304 - Fax 707 778 4437  
 Approved By  
*Thomas S. Hargis*  
 Thomas S. Hargis R.C.E. 22366

Standard Details  
 CURB  
 &  
 GUTTER

Drawn By  
 Butch Smith  
 Scale  
 N.T.S.  
 Date  
 September 4th 1996  
 File Number  
 Std Det SSS0000 204 2 of 2



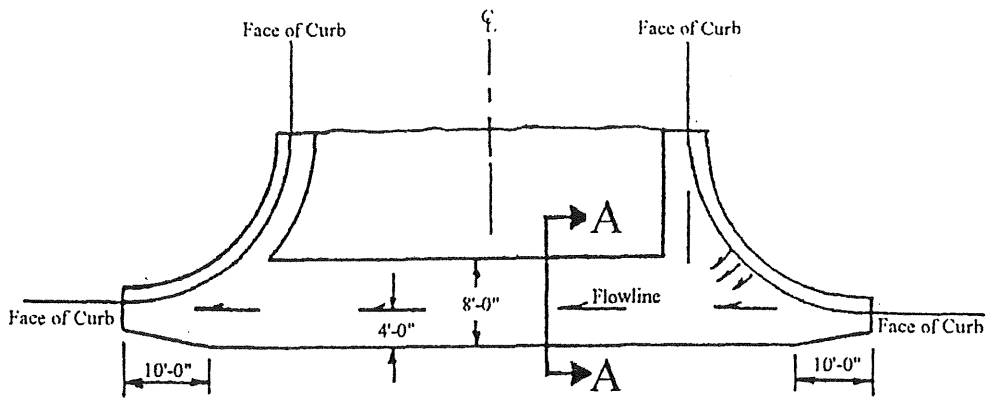

VALLEY GUTTER DETAIL

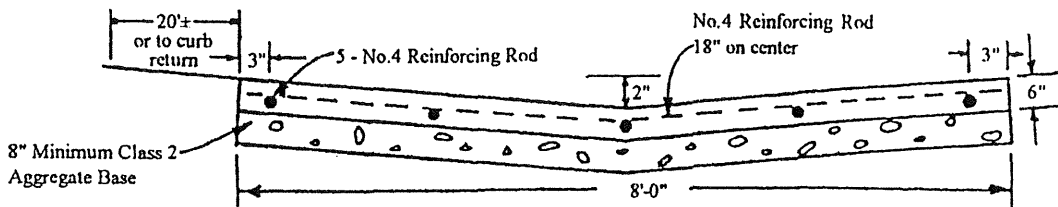

SECTION A-A  
STANDARD VALLEY GUTTER DETAIL

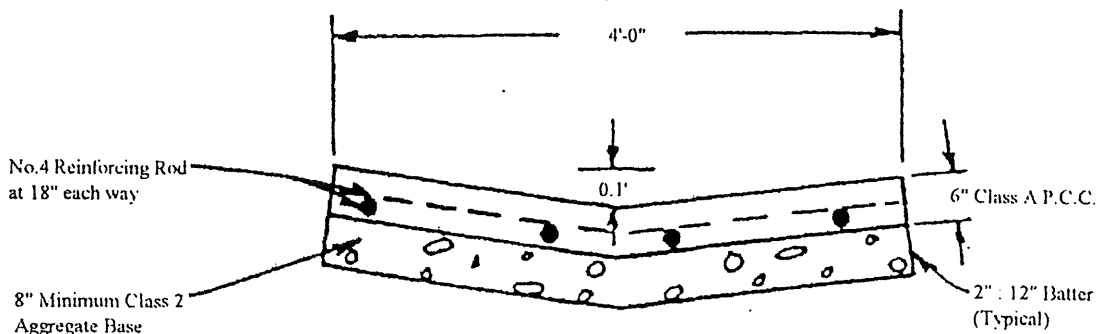

VALLEY GUTTER MINOR CUL-DE-SAC

CITY OF PETALUMA  
Department of Engineering  
22 Bassett Street - Petaluma, California 94952  
707.738.4304 - Fax 707.738.4437  
Approved By  
*Thomas S. Harris*  
Thomas S. Harris - R.C.E. 22366

Standard Details  
**VALLEY  
GUTTER**

Drawn by  
**Butch Smith**  
Scale  
**N. T. S.**  
Date  
**September 4th 1996**  
File Number  
Std. Det. SSS0000 205

  
Page  
**205**

**SECTION VI**  
**LOCATION EXHIBITS**

Water Field Office - Lucchesi Park  
New Sidewalk Location

5' wide Concrete Sidewalk  
Slope 4% max  
Final Alignment during Pre-Con



N McDowell Blvd

202 North McDowell Blvd



Casa Grande Rd.  
Sidewalk Repair Sections

Remove and Replace  
Concrete Sections  
Casa Grande Rd



Crinella Dr

Casa Grande Rd

Del Oro Cir

Del Sol Ct



Sutter St. & E. Washington St.  
Sidewalk Repair Sections

Remove and Replace  
Concrete Sections

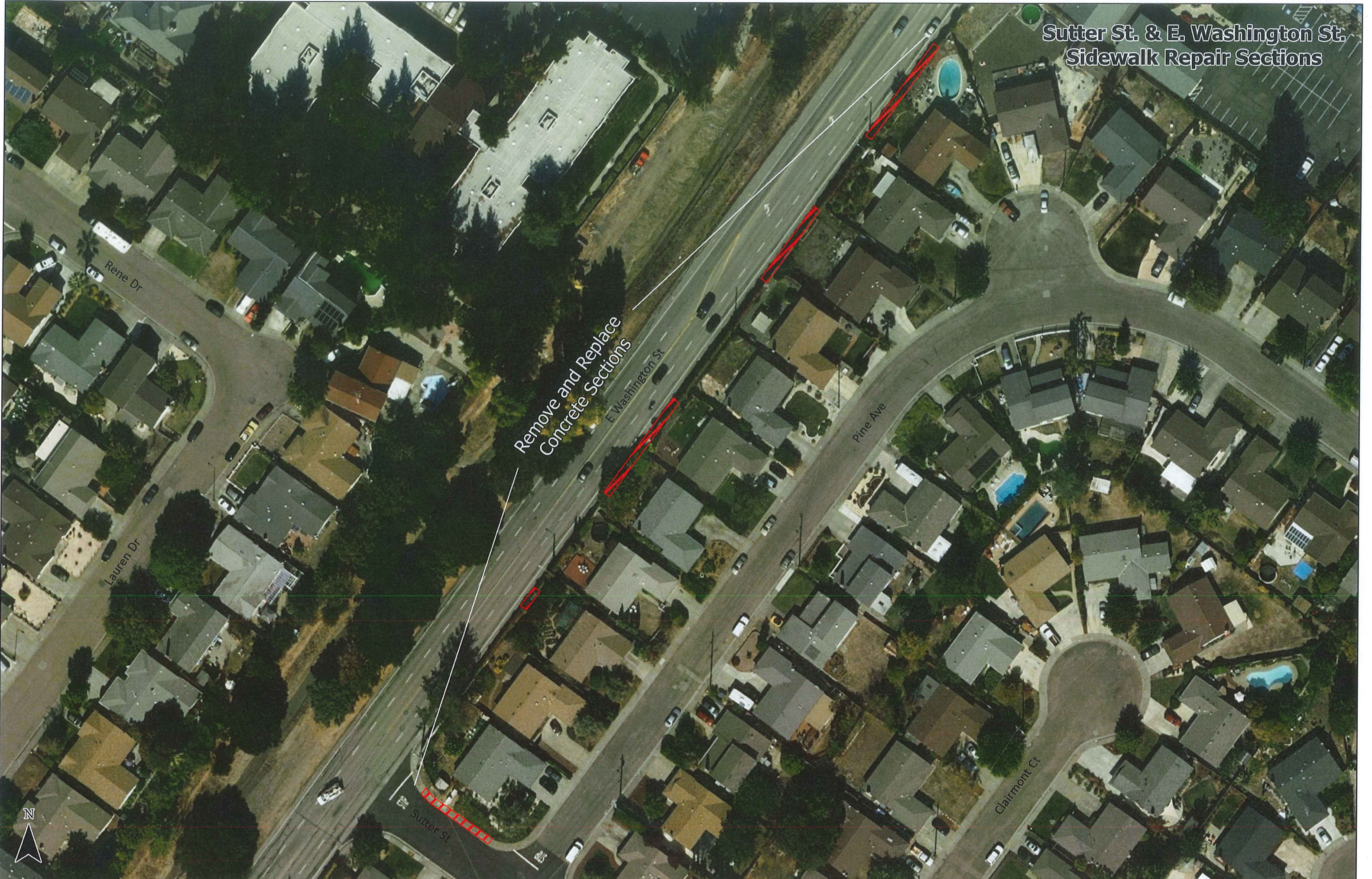

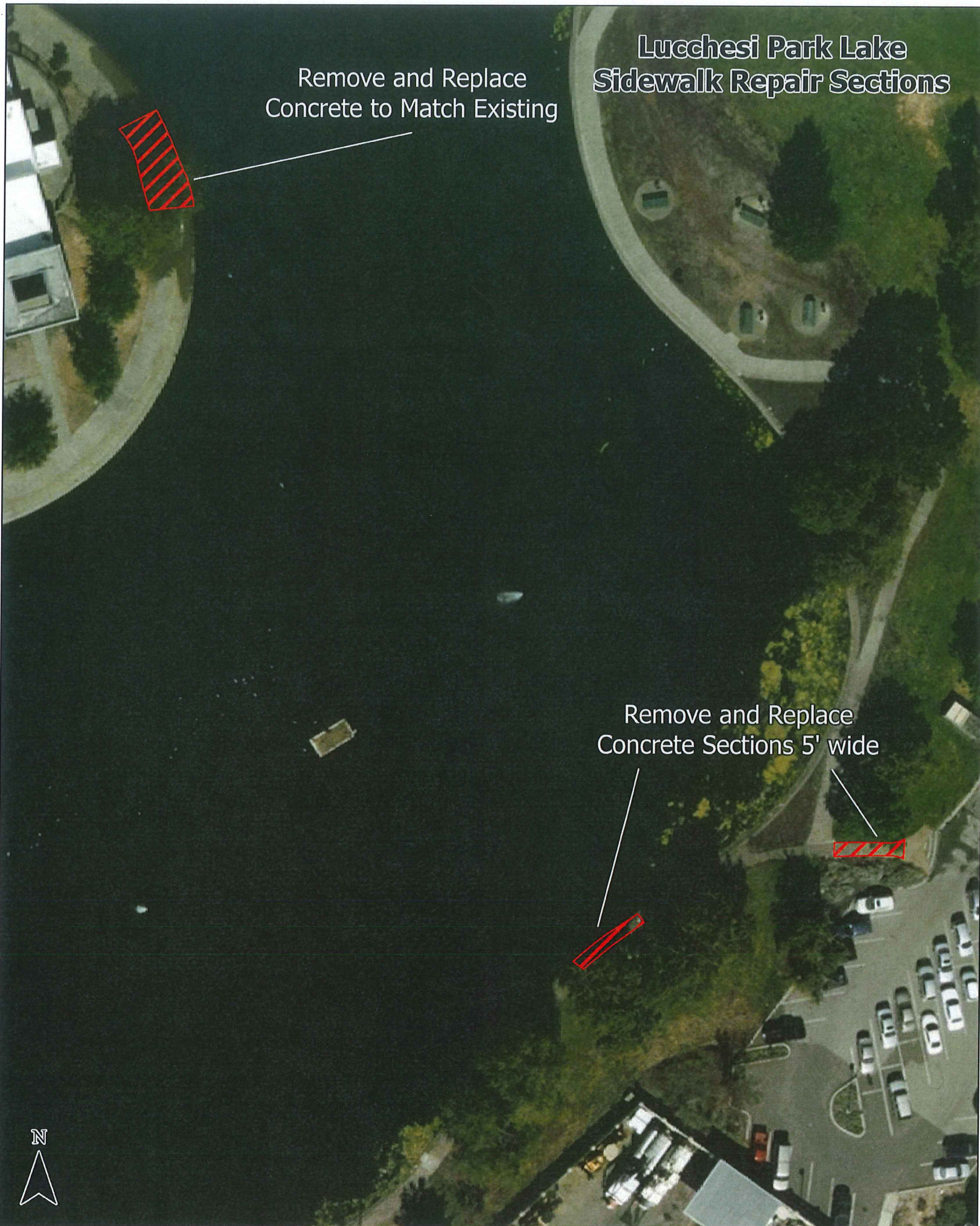

Lakeville St.  
Sidewalk Repairs Location

PG&E

5' wide TYP  
Meandering Sidewalk  
at Grade

14' wide Concrete Driveway  
Approval

Lakeville St

Minimum 4' wide Sidewalk  
Adjacent to Utility Boxes  
Typical

CVS

